



Operation Manual

Smart-UPS™ X Uninterruptible Power Supply

SMX750 VA
SMX1000 VA
SMX 1500 VA
120 Vac/230 Vac

Rack-Mount 2U

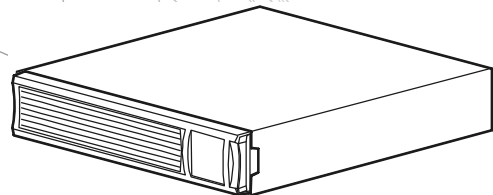

Product Description

The APC™ by Schneider Electric Smart-UPS™ is a high performance uninterruptible power supply (UPS). The UPS provides protection for electronic equipment from utility power blackouts, brownouts, sags, and surges, small utility power fluctuations and large disturbances. The UPS also provides battery backup power for connected equipment until utility power returns to safe levels or the batteries are fully discharged.

This user manual is available on the enclosed CD and on the APC by Schneider Electric web site, www.apc.com.

Important Safety Messages

Read the instructions carefully to become familiar with the equipment before trying to install, operate, service or maintain it. The following special messages may appear throughout this manual or on the equipment to warn of potential hazards or to call attention to information that clarifies or simplifies a procedure.



The addition of this symbol to a Caution product safety label indicates that a hazard exists that can result in injury and product damage if the instructions are not followed.

The following safety messages may appear throughout this manual to warn of potential hazards.

| |
|---|
|  CAUTION |
| CAUTION indicates a potentially hazardous situation which, if not avoided, can result in equipment damage and minor or moderate injury. |

| |
|--|
| CAUTION |
| CAUTION indicates a potentially hazardous situation which, if not avoided, can result in equipment damage. |

Safety and General Information

Inspect the package contents upon receipt. Notify the carrier and dealer if there is any damage.

Read the Safety Guide supplied with this unit before installing the UPS.

- Adhere to all local and national electrical codes.
- This UPS is intended for indoor use only.
- Do not operate this UPS in direct sunlight, in contact with fluids, or where there is excessive dust or humidity.
- Be sure the air vents on the UPS are not blocked. Allow adequate space for proper ventilation.
- The battery typically lasts for two to five years. Environmental factors impact battery life. Elevated ambient temperatures, poor quality utility power, and frequent short duration discharges will shorten battery life.
- Connect the UPS power cable directly to a wall outlet. Do not use surge protectors or extension cords.

Product Overview

Front Panel Features

- ❶ Battery
- ❷ Battery connector
- ❸ Display interface
- ❹ Bezel

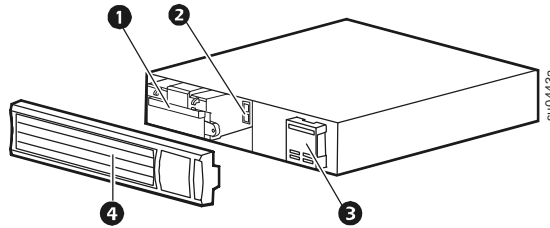

Rear Panel Features

- ❶ SmartSlot
- ❷ External battery pack connector
- ❸ Outlets
- ❹ EPO connector
- ❺ USB port
- ❻ Serial port
- ❼ Chassis ground screw
- ❽ UPS input
- ❾ Circuit breaker

120 Vac

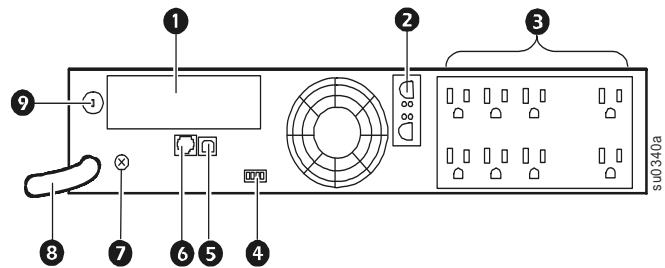

230 Vac

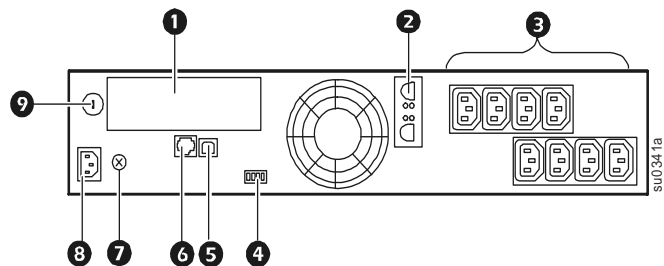

Specifications

Environmental Specifications

For additional specifications, refer to the APC by Schneider Electric web site at www.apc.com.

| | | |
|--------------------------|---|---|
| Temperature | Operating | 0° to 40° C (32° to 104° F) |
| | Storage | -15° to 45° C (5° to 113° F) charge UPS battery every six months |
| Maximum Elevation | Operating | 3,000 m (10,000 ft) |
| | Storage | 15,000 m (50,000 ft) |
| Humidity | 0% to 95% relative humidity, non-condensing | |

Installation

UPS

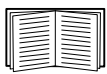

For UPS installation information, refer to the Smart-UPS X Installation Guide that is included with the UPS. The guide is also available on the enclosed CD and the APC by Schneider Electric web site at www.apc.com.

Network Management Card

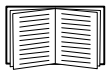

For installation information, refer to the user manual provided with the Network Management Card (NMC). The user manual is also available on the APC by Schneider Electric web site at www.apc.com.

External Battery Pack

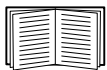

For installation information, refer to the SMX48RMBP2U external battery pack Installation Guide that is included with the external battery pack (XLBP). The guide is also available on the enclosed CD and the APC by Schneider Electric web site at www.apc.com.

Operation

Connect Equipment to the UPS

CAUTION

RISK OF EQUIPMENT DAMAGE

- Adhere to all local and national electrical codes.
- Wiring should be performed by qualified electrician.
- Always connect the UPS to a grounded outlet.

Failure to follow these instructions can result in equipment damage



Note: The UPS will charge to 90% capacity in the first three hours of normal operation. **Do not expect full battery runtime capability during this initial charge period.**

1. Connect equipment to the outlets on the rear panel of the UPS.
2. Connect the UPS to the building utility power.
Always connect the UPS to a two pole, three wire, grounded source.
3. To use the UPS as a master ON/OFF switch, turn on all the equipment that is connected to the UPS.
4. Press the ON/OFF button on the front panel of the UPS to turn on the UPS and all connected equipment.
5. See “Controllable Outlet Groups” on page 8 for information on how to use the Controllable Outlet Groups.

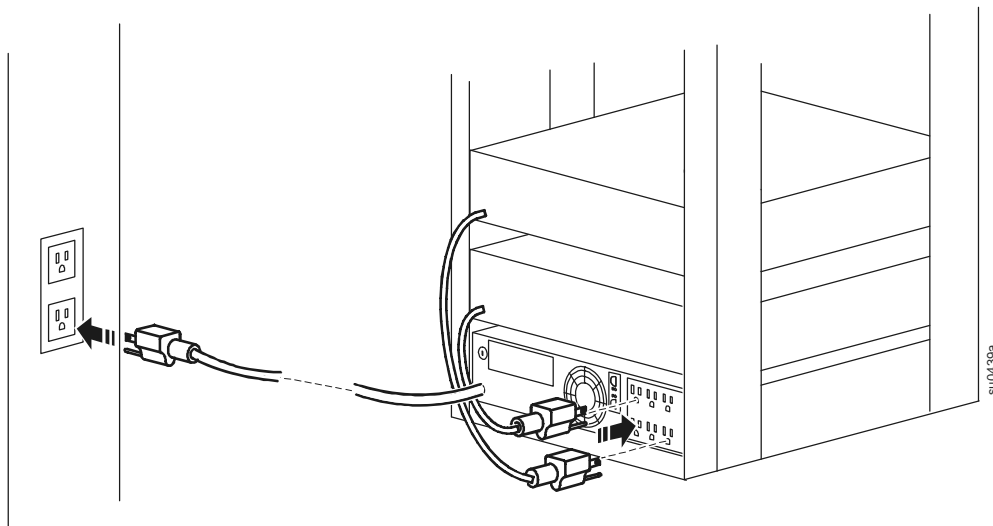

Basic Connectors



Serial port: Connect to a computer to use power management software.



USB port: Connect to a computer to use power management software.

Note: Serial and USB communication can not be used simultaneously.



External Battery Pack connector: Connect external battery packs to provide extended runtime during power outages. The UPS can support up to five external battery packs.



Ground Screw: The UPS features a ground screw for connecting the ground lead on surge suppression devices such as a telephone and network line protectors. When connecting a ground cable, disconnect the UPS from utility power.

Display Panel

Overview

- 1 Online LED
- 2 UPS Output On/Off button
- 3 On Battery LED
- 4 Site Wiring Fault LED
- 5 Replace Battery LED
- 6 Display screen
- 7 UP/DOWN arrow buttons
- 8 ENTER button
- 9 ESCAPE button

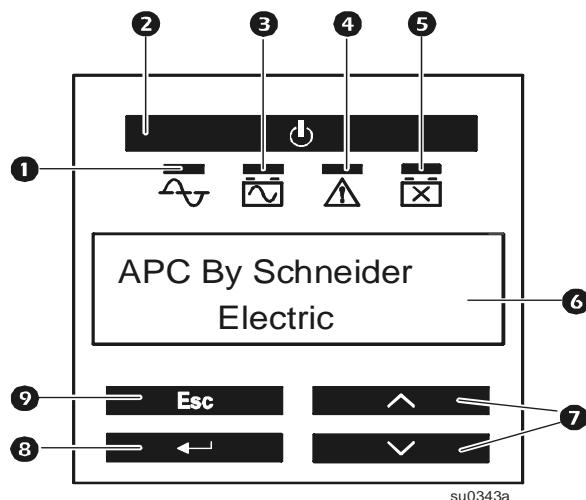

Using the display interface

Use the UP/DOWN arrow buttons to scroll through the main menu options. Press ENTER to view the submenus under each main menu option. Press ESCAPE to exit a submenu and return to a main menu.

Standard menus

The Standard menus are the most commonly used menus for the UPS.

| Menu | General Functions |
|-------------------------|--|
| Status | View basic information about the UPS: <ul style="list-style-type: none"> • Operating mode • Switched Outlet status, On or Off • Efficiency of the UPS • Information about the load • Battery capacity • Estimated runtime • Input and output voltage and frequency • Information about the last transfer to battery power • Self-test results • SmartSlot Card information |
| Configuration | Configure the settings for the UPS: <ul style="list-style-type: none"> • Language • Local power quality: Good, Fair, Poor • Choose Standard or Advanced menus • UPS Test settings • Reset to Factory Defaults |
| Test & Diags | Use the Test & Diags menu to have the UPS perform a self-test. |
| About | Display information about this unit: <ul style="list-style-type: none"> • Unit model number • Serial number • Battery information <ul style="list-style-type: none"> • Model number • Installation date • Suggested battery replacement date • UPS firmware version |

Advanced menus

The Advanced menus provide additional options for the UPS and are available only if the display interface is configured to use the Advanced menus.

| Menu | General Functions |
|-------------------------|--|
| Status | View detailed information about the UPS: <ul style="list-style-type: none">• Energy meter• Load current• Status of the SWITCHED OUTLET GROUP(S)• Battery voltage• Efficiency |
| Configuration | Configure advanced settings for the UPS: <ul style="list-style-type: none">• MAIN AND SWITCHED OUTLET GROUPS—delays and settings• High and lower transfer points• Sensitivity settings• Date of last battery replacement• Output voltage• Battery settings• Number of battery packs (not available on all models)• Reset energy meter• UPS test settings |
| Control | Control the MAIN AND SWITCHED OUTLET GROUPS to turn on, turn off, shutdown, or reboot. |
| Test & Diags | Perform UPS test and diagnostic functions such as user interface testing, battery tests, and battery calibration. |
| Log | View the event and error logs for information about any changes to the UPS and any faults. |
| About | View information about the unit: <ul style="list-style-type: none">• Hardware version• Software version• NMC information (if applicable)• SmartSlot Card information (if applicable) |

Configuration

UPS Settings

Start up settings

Configure these settings at initial start up, using the display interface or PowerChute™ software.



Note: During start up, use the display interface to configure these settings. If nothing is selected, the unit will use the default settings.

| Function | Factory Default | Options | Description |
|---------------------|-----------------|---|---|
| Language | English | <ul style="list-style-type: none">• English• French*• German*• Spanish*• Italian*• Portuguese* | The language for the display interface. *Language options will vary by model. |
| Local Power Quality | Good | <ul style="list-style-type: none">• Good• Fair• Poor | Select the quality of input utility power. <ul style="list-style-type: none">• If Good is selected, the unit will go on battery power more often to provide the cleanest power supply to the connected equipment.• If Poor is selected, the UPS will tolerate more fluctuations in power and will go on battery power less often. If unsure of the local power quality, select Good. |
| Menu Type | Standard | Standard or Advanced | The Standard menus display a limited set of menus and options. The Advanced menus include all parameters. |

General Settings

Configure these settings at any time, using the display interface or PowerChute software.

| Function | Factory Default | Options | Description |
|------------------------|----------------------------------|--|---|
| High transfer point | 120 V: 140 Vac | 120 V: 140-150 Vac | To avoid unnecessary battery usage, set the transfer point higher if the utility voltage is chronically high and the connected equipment is known to work under this condition. The POWER QUALITY setting will automatically change this setting. Note: Use the Advanced Menus to configure this setting. |
| | 230 V: 280 Vac | 230 V: 280-300 Vac | |
| Low Transfer Point | 120 V: 85 Vac | 120 V: 75-85 Vac | Set the transfer point lower if the utility voltage is chronically low and the connected equipment can tolerate this condition. This setting may also be adjusted using the power quality setting. Note: Use the Advanced Menus to configure this setting. |
| | 230 V: 170 Vac | 230 V: 150-170 Vac | |
| Nominal Output Voltage | 230 V: 230 Vac 120 V: 120 Vac | 230 V: 220, 230, 240 Vac 120 Vac: N/A | Set the nominal output voltage of the UPS on battery. This is available on 230 V models only. |

| Function | Factory Default | Options | Description |
|---|---|--|--|
| Transfer Sensitivity | High | High, Low, Medium | Select the level of sensitivity to power events that the UPS will tolerate. <ul style="list-style-type: none"> • High: The UPS will go on battery power more often to provide the cleanest power supply to the connected equipment. • Low: The UPS will tolerate more fluctuations in power and will go on battery power less often. <p>If the connected load is sensitive to power disturbances, set the sensitivity to High.</p> |
| Low Battery Warning | 150 sec | Set the value in seconds | The UPS will emit an audible alarm when the remaining runtime has reached this level. |
| Date of Last Battery Replacement | Date set at factory | Reset this date when the battery module is replaced. | |
| Audible Alarm | On | On/Off | The UPS will mute all audible alarms if this is set to Off or when the display buttons are pressed. |
| Battery Self-Test Interval Setting | On start up and every 14 days since the last test | <ul style="list-style-type: none"> • Never • Start up only • Frequency of test (days) | The interval at which the UPS will execute a self-test. |
| Reset to Factory Default | No | Yes/No | Restore the UPS factory default settings. |

Controllable Outlet Groups

Overview

The rear panel of the UPS has multiple outlets, some are grouped into Controllable Outlet Groups, all of the other outlets are the UPS outlets, which function as an outlet group. All of these groups can independently turn off, turn on, shut down, and reboot connected equipment.

The Controllable Outlet Groups can be commanded to do the following:

- Turn off: Disconnect from power immediately and restart only with a manual command
- Turn on: Connect to power immediately
- Shutdown: Disconnect power in sequence, and automatically reapply power in sequence when utility power becomes available
- Reboot: Shut down and restart

In addition, the Controllable Outlet Groups and the UPS outlets can be configured to do the following:

- Turn on or off in a specified sequence
- Automatically turn off or shut down when various conditions occur



Note: If the Controllable Outlet Groups are not configured, all of the outlets on the unit will still provide battery backup power.

Model specific controllable outlet groups

① Controllable Outlet Group(s)

② UPS outlets

750 VA 120 Vac

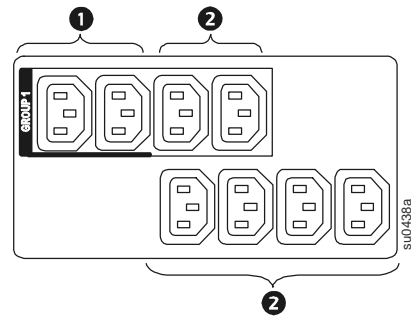
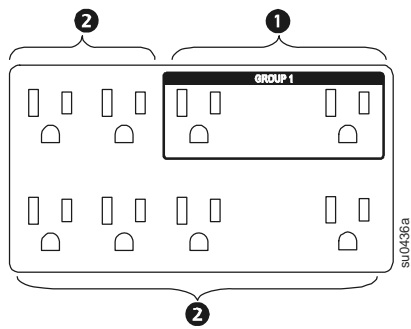

1000 VA 120/230 Vac

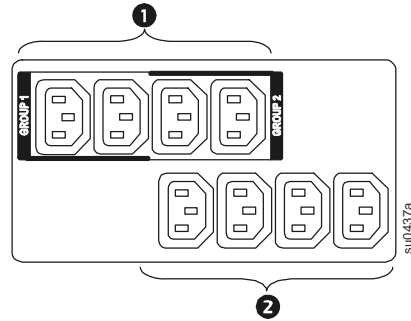
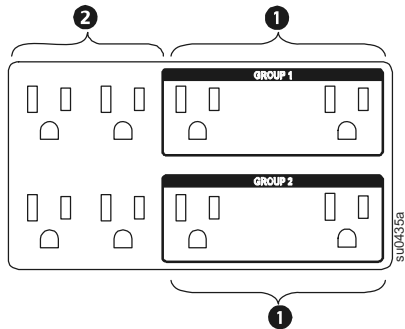

1500 VA 120/230 Vac

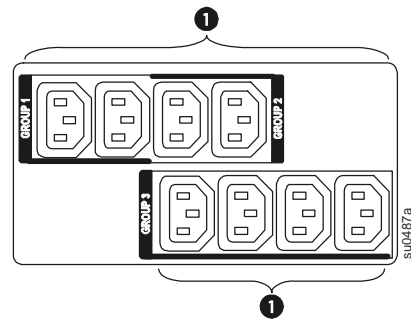
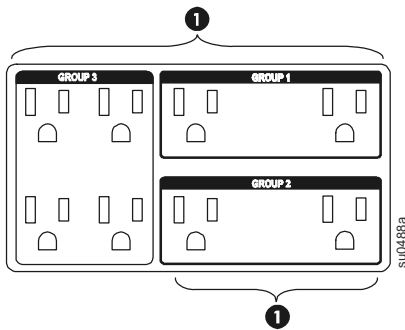

Using the controllable outlet groups and UPS outlets



The UPS outlets function as a master switch. They turn on first when power is applied, shut off last when there is a power outage and battery runtime has been exhausted.

The UPS outlets must be turned on for the Controllable Outlet Groups to turn on.

1. Connect critical equipment to the UPS outlets (The 1500 VA units do not have UPS outlets. Connect all critical equipment to the same outlet group.)
2. Connect peripheral equipment to the Controllable Outlet Groups.
 - Nonessential equipment that should shut off quickly in the event of a power outage to conserve battery runtime can be added to a short power off delay
 - If equipment has dependent peripherals that must restart or shut down in a specific order, such as an ethernet switch that must restart before a connected server, connect the devices to separate groups
 - Equipment that needs to reboot independently from other equipment should be added to a separate group
3. Use the Configuration menus to configure how the Controllable Outlet Groups will react in the event of a power outage.

Customize the controllable outlet groups and the UPS outlets

Use the **Control** menus to change the controllable outlet groups and the UPS outlet settings.

| Function | Factory Default | Options | Description |
|---------------------------------------|-----------------|--|--|
| Name String Outlet Group | Outlet Group 1 | | |
| UPS Name String | UPS Outlets | | |
| Turn On Delay | 0 sec | Set the value in seconds | The amount of time the UPS or Controllable Outlet Group will wait between receiving the command to turn on and the actual startup. |
| Turn Off Delay | 0 sec | Set the value in seconds | The amount of time that the UPS or Controllable Outlet Group will wait between receiving the command to turn off and the actual shut down. |
| Reboot Duration | 4 sec | Set the value in seconds | The amount of time that the UPS or Controllable Outlet Group must remain off before it will restart. |
| Minimum Return Time | 0 sec | Set the value in seconds | The amount of battery runtime that must be available before the UPS or Controllable Outlet Group will turn on. |
| Load Shed On Battery | Disabled | <ul style="list-style-type: none"> • Shutdown with Delay • Shutdown immediately • Turn off immediately • Turn off with delay • Disabled | <p>When the unit switches to battery power, the UPS can disconnect power to the Controllable Outlet Groups to save runtime.</p> <p>Configure this delay time, use the LOAD SHED TIME WHEN ON BATTERY setting.</p> |
| Load Shed Time when On Battery | Disabled | Set the value in seconds | The amount of time the outlets will function on battery power before they will turn off. |
| Load Shed On Runtime | Disabled | <ul style="list-style-type: none"> • Shutdown with delay • Shutdown immediately • Turn off immediately • Turn off with delay • Disabled | <p>When the battery runtime falls below the specified value, the Controllable Outlet Group will turn off.</p> <p>Configure this time using the LOAD SHED RUNTIME REMAINING setting.</p> |
| Load Shed On Runtime Remaining | Disabled | Set the value in seconds | When the remaining runtime reaches this level, the Controllable Outlet Group will turn off. |
| Load Shed on Overload | Disabled | <ul style="list-style-type: none"> • Disabled • Enabled | In the event of an overload (greater than 100% output), the Controllable Outlet Group will immediately turn off to conserve power for critical loads. The Controllable Outlet Group will only turn on again with a manual command. |

Network Management Card Settings

These settings are available only on units that have a Network Management Card (NMC) and are set in the factory. These settings can only be modified using an external interface, like the NMC web interface.

- NMC IP Address Mode
- NMC IP Address
- NMC Subnet Mask
- NMC Default Gateway

Emergency Power Off

Overview

The Emergency Power Off (EPO) option is a safety feature that will immediately disconnect all connected equipment from utility power. The UPS will immediately shut down and will not switch to battery power.

Connect each UPS to the EPO switch, even if the UPS units are used in parallel.

The UPS must be restarted for power to return to connected equipment. Press the ON/OFF button on the front panel of the UPS.

Adhere to all local and national electrical codes. All wiring must be performed by a qualified electrician.

Normally open contacts

1. If the EPO switch or relay contacts are normally open, insert the wires from the switch or contacts at pins 1 and 2 of the EPO terminal block. Use 16-28 AWG wire.
2. Secure the wires by tightening the screws.

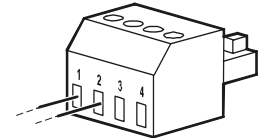

If the contacts are closed, the UPS will turn OFF and power will be removed from the load.

Normally closed contacts

1. If the EPO switch or relay contacts are normally closed, insert the wires from the switch or contacts at pins 2 and 3 of the EPO terminal block. Use 16-28 AWG wire.
2. Insert a wire jumper between pins 1 and 2. Secure the wires by tightening the three screws at positions 1, 2, and 3.

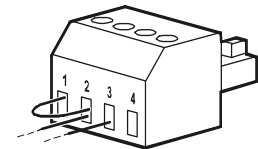

If the contacts are opened, the UPS will turn OFF and power will be removed from the load.

Note: Pin 1 is the power source for the EPO circuit, it provides a few milliamperes of 24 V power.

If the normally closed (NC) EPO configuration is used, the EPO switch or relay should be rated for dry circuit applications, the rating should be for low voltage and low current applications. This normally implies the contacts are gold-plated.

The EPO interface is a Safety Extra Low Voltage (SELV) circuit. Connect the EPO interface only to other SELV circuits. The EPO interface monitors circuits that have no determined voltage potential. SELV circuits are controlled by a switch or relay properly isolated from utility power. To avoid damage to the UPS, do not connect the EPO interface to any circuit other than a SELV circuit.

Use one of the following cable types to connect the UPS to the EPO switch.

- CL2: Class 2 cable for general use.
- CL2P: Plenum cable for use in ducts, plenums, and other spaces used for environmental air.
- CL2R: Riser cable for use in a vertical run in a floor-to-floor shaft.
- CLEX: Limited use cable for use in dwellings and for use in raceways.
- Installation in Canada: Use only CSA certified, type ELC, (extra low voltage control cable).
- Installation in countries other than Canada and the USA: Use standard low voltage cable in accordance with national and local regulations.

Troubleshooting

| Problem and Possible Cause | Solution |
|-----------------------------------|-----------------|
|-----------------------------------|-----------------|

The UPS will not turn on or there is no output

| | |
|---|---|
| The unit has not been turned on. | Press the ON button once to turn on the UPS. |
| The UPS is not connected to utility power. | Be sure that the power cable is securely connected to the unit and to the utility power supply. |
| The input circuit breaker has tripped. | Reduce the load to the UPS, disconnect nonessential equipment and reset the circuit breaker. |
| The unit shows very low or no input utility voltage. | Check the utility power supply to the UPS by plugging in a table lamp. If the light is very dim, check the utility voltage. |
| The battery connector plug is not securely connected. | Be sure that all battery connections are secure. |
| There is an internal UPS fault. | Do not attempt to use the UPS. Unplug the UPS and have it serviced immediately. |

The UPS is operating on battery, while connected to utility power

| | |
|--|---|
| The input circuit breaker has tripped. | Reduce the load to the UPS, disconnect nonessential equipment and reset the circuit breaker. |
| There is very high, very low, or distorted input line voltage. | Move the UPS to a different outlet on a different circuit. Test the input voltage with the utility voltage display. If acceptable to the connected equipment, reduce the UPS sensitivity. |

UPS is emits intermittent beeps

| | |
|---------------------------------|--|
| The UPS is in normal operation. | None. The UPS is protecting the connected equipment. |
|---------------------------------|--|

UPS does not provide expected backup time

| | |
|--|---|
| The UPS battery is weak due to a recent outage or is near the end of its service life. | Charge the battery. Batteries require recharging after extended outages and wear out faster when put into service often or when operated at elevated temperatures. If the battery is near the end of its service life, consider replacing the battery even if the replace battery indicator is not yet illuminated. |
| The UPS is overloaded. | Check the UPS load display. Unplug unnecessary equipment, such as printers. |

Display interface LEDs flash sequentially

| | |
|---|--|
| The UPS has been shut down remotely through software or an optional accessory card. | None. The UPS will restart automatically when utility power is restored. |
|---|--|

The Site Wiring Fault LED illuminates The UPS displays a fault message and emits a constant beeping sound

| | |
|---------------------|---|
| Internal UPS fault. | Do not attempt to use the UPS. Turn the UPS off and have it serviced immediately. |
|---------------------|---|

| Problem and Possible Cause | Solution |
|-----------------------------------|-----------------|
|-----------------------------------|-----------------|

All LEDs are illuminated and the UPS is plugged into a wall outlet

The UPS has shut down and the battery has discharged from an extended outage.

None. The UPS will return to normal operation when the power is restored and the battery has a sufficient charge.

The Replace Battery LED is illuminated

The battery has a weak charge.

Allow the battery to recharge for at least four hours. Then, perform a self-test. If the problem persists after recharging, replace the battery.

The replacement battery is not properly connected.

Be sure that the battery connector is securely connected.

The UPS displays a site wiring fault message

Wiring faults detected include missing ground, hot-neutral, polarity reversal, and overloaded neutral circuit.

If the UPS indicates a site wiring fault, have a qualified electrician inspect the building wiring. (Applicable for 120 V units only.)

Service

If the unit requires service, do not return it to the dealer. Follow these steps:

1. Review the *Troubleshooting* section of the manual to eliminate common problems.
2. If the problem persists, contact APC by Schneider Electric Customer Support through the APC by Schneider Electric web site, **www.apc.com**.
 - a. Note the model number and serial number and the date of purchase. The model and serial numbers are located on the rear panel of the unit and are available through the LCD display on select models.
 - b. Call APC by Schneider Electric Customer Support and a technician will attempt to solve the problem over the phone. If this is not possible, the technician will issue a Returned Material Authorization Number (RMA#).
 - c. If the unit is under warranty, the repairs are free.
 - d. Service procedures and returns may vary internationally. Refer to the APC by Schneider Electric web site for country specific instructions.
3. Pack the unit in the original packaging whenever possible to avoid damage in transit. Never use foam beads for packaging. Damage sustained in transit is not covered under warranty.
 - a. **Always DISCONNECT THE UPS BATTERIES before shipping. The United States Department of Transportation (DOT), and the International Air Transport Association (IATA) regulations require that UPS batteries be disconnected before shipping.** The internal batteries may remain in the UPS.
 - b. External Battery Pack products are deenergized when disconnected from the associated UPS product. It is not necessary to disconnect the internal batteries for shipping. Not all units utilize an external battery pack.
4. Write the RMA# provided by Customer Support on the outside of the package.
5. Return the unit by insured, prepaid carrier to the address provided by Customer Support.

Transport the unit

1. Shut down and disconnect all connected equipment.
2. Disconnect the unit from utility power.
3. Disconnect all internal and external batteries (if applicable).
4. Follow the shipping instructions outlined in the *Service* section of this manual.

Limited Factory Warranty

Schneider Electric IT Corporation (SEIT), warrants its products to be free from defects in materials and workmanship for a period of two (2) years from the date of purchase. The SEIT obligation under this warranty is limited to repairing or replacing, at its own sole option, any such defective products. Repair or replacement of a defective product or parts thereof does not extend the original warranty period.

This warranty applies only to the original purchaser who must have properly registered the product within 10 days of purchase. Products may be registered online at warranty.apc.com.

SEIT shall not be liable under the warranty if its testing and examination disclose that the alleged defect in the product does not exist or was caused by end user or any third person misuse, negligence, improper installation, testing, operation or use of the product contrary to SEIT recommendations or specifications. Further, SEIT shall not be liable for defects resulting from: 1) unauthorized attempts to repair or modify the product, 2) incorrect or inadequate electrical voltage or connection, 3) inappropriate on site operation conditions, 4) Acts of God, 5) exposure to the elements, or 6) theft. In no event shall SEIT have any liability under this warranty for any product where the serial number has been altered, defaced, or removed.

EXCEPT AS SET FORTH ABOVE, THERE ARE NO WARRANTIES, EXPRESS OR IMPLIED, BY OPERATION OF LAW OR OTHERWISE, APPLICABLE TO PRODUCTS SOLD, SERVICED OR FURNISHED UNDER THIS AGREEMENT OR IN CONNECTION HEREWITH.

SEIT DISCLAIMS ALL IMPLIED WARRANTIES OF MERCHANTABILITY, SATISFACTION AND FITNESS FOR A PARTICULAR PURPOSE.

SEIT EXPRESS WARRANTIES WILL NOT BE ENLARGED, DIMINISHED, OR AFFECTED BY AND NO OBLIGATION OR LIABILITY WILL ARISE OUT OF, SEIT RENDERING OF TECHNICAL OR OTHER ADVICE OR SERVICE IN CONNECTION WITH THE PRODUCTS.

THE FOREGOING WARRANTIES AND REMEDIES ARE EXCLUSIVE AND IN LIEU OF ALL OTHER WARRANTIES AND REMEDIES. THE WARRANTIES SET FORTH ABOVE CONSTITUTE SEIT SOLE LIABILITY AND PURCHASER EXCLUSIVE REMEDY FOR ANY BREACH OF SUCH WARRANTIES. SEIT WARRANTIES EXTEND ONLY TO ORIGINAL PURCHASER AND ARE NOT EXTENDED TO ANY THIRD PARTIES.

IN NO EVENT SHALL SEIT, ITS OFFICERS, DIRECTORS, AFFILIATES OR EMPLOYEES BE LIABLE FOR ANY FORM OF INDIRECT, SPECIAL, CONSEQUENTIAL OR PUNITIVE DAMAGES, ARISING OUT OF THE USE, SERVICE OR INSTALLATION OF THE PRODUCTS, WHETHER SUCH DAMAGES ARISE IN CONTRACT OR TORT, IRRESPECTIVE OF FAULT, NEGLIGENCE OR STRICT LIABILITY OR WHETHER SEIT HAS BEEN ADVISED IN ADVANCE OF THE POSSIBILITY OF SUCH DAMAGES. SPECIFICALLY, SEIT IS NOT LIABLE FOR ANY COSTS, SUCH AS LOST PROFITS OR REVENUE, WHETHER DIRECT OR INDIRECT, LOSS OF EQUIPMENT, LOSS OF USE OF EQUIPMENT, LOSS OF SOFTWARE, LOSS OF DATA, COSTS OF SUBSTITUANTS, CLAIMS BY THIRD PARTIES, OR OTHERWISE.

NOTHING IN THIS LIMITED WARRANTY SHALL SEEK TO EXCLUDE OR LIMIT SEIT LIABILITY FOR DEATH OR PERSONAL INJURY RESULTING FROM ITS NEGLIGENCE OR ITS FRAUDULENT MISREPRESENTATION OF TO THE EXTENT THAT IT CANNOT BE EXCLUDED OR LIMITED BY APPLICABLE LAW.

To obtain service under warranty you must obtain a Returned Material Authorization (RMA) number from customer support. Customers with warranty claims issues may access the SEIT worldwide customer support network through the APC web site: www.apc.com. Select your country from the country selection drop down menu. Open the Support tab at the top of the web page to obtain information for customer support in your region. Products must be returned with transportation charges prepaid and must be accompanied by a brief description of the problem encountered and proof of date and place of purchase.

APC by Schneider Electric Worldwide Customer Support

Customer support for this or any other APC by Schneider Electric product is available at no charge in any of the following ways:

- Visit the APC by Schneider Electric Web site to access documents in the APC by Schneider Electric Knowledge Base and to submit customer support requests.
 - **www.apc.com** (Corporate Headquarters)
Connect to localized APC by Schneider Electric Web sites for specific countries, each of which provides customer support information.
 - **www.apc.com/support/**
Global support searching APC by Schneider Electric Knowledge Base and using e-support.
- Contact the APC by Schneider Electric Customer Support Center by telephone or e-mail.
 - Local, country specific centers: go to **www.apc.com/support/contact** for contact information.
 - For information on how to obtain local customer support, contact the APC by Schneider Electric representative or other distributors from whom you purchased your APC by Schneider Electric product.



Select models are ENERGY STAR[®] qualified.
For more information go to www.apc.com/site/recycle/index.cfm/energy-efficiency/energy-star/

© 2015 APC by Schneider Electric. APC, the APC logo, Smart-UPS and PowerChute are owned by Schneider Electric Industries S.A.S. or their affiliated companies. All other trademarks are property of their respective owners.