



Introduction

A.I.M. basics	3
Supplied items	5

Installation

Connections	6
Installation requirements	7
Mounting the A.I.M. server	8

Configuration

Supported browsers	9
Login for admin users	9
Important first configuration steps	10
Adding AdderLink Infinity units	11
If an ALIF unit is not located	11
AdderLink Infinity manual factory reset	11
The Dashboard tab	12
Upgrading ALIF firmware globally	20
Upgrading (or downgrading) A.I.M. firmware	21
The Channels tab	23
The Receivers tab	26
The Transmitters tab	30
The Servers tab	33
The Users tab	34
The Presets tab	38
The Statistics tab	40

Operation

Logging in	41
The Local OSD screen	42
Using the Remote OSD feature	43

Further information

Getting assistance	44
Appendix A - Tips for success when networking ALIF units	45
Appendix B - Troubleshooting	47
Appendix C - Redundant servers: Setting up and swapping out	49
Setting up A.I.M. server redundancy	49
Operation of Redundancy	49
Swapping out an A.I.M. server	50
Appendix D - Upgrade license	51
Appendix E - Glossary	52
Appendix F - A.I.M. API	55
Appendix G - DHCP server requirements for ALIF support	65
Appendix H - Technical specifications	66
Warranty	67
Safety information	67
Lithium battery	67
Radio Frequency Energy	68

Index

Introduction

AdderLink Infinity transmitter and receiver units allow multiple remote users to access host computers in a very flexible manner. Such flexibility requires management and coordination – that is where A.I.M. (AdderLink Infinity Manager) becomes vital.

A.I.M. is designed to promote the most efficient use of AdderLink Infinity (ALIF) units by allowing central control over any number of transmitters and receivers. Using the intuitive A.I.M. web-based interface, one or more administrators can manage potentially thousands of users who are interacting with an almost unlimited number of devices.

A.I.M. operates as a self-contained compact server (including its own DHCP server) unit that can be situated anywhere within your network of ALIF devices:

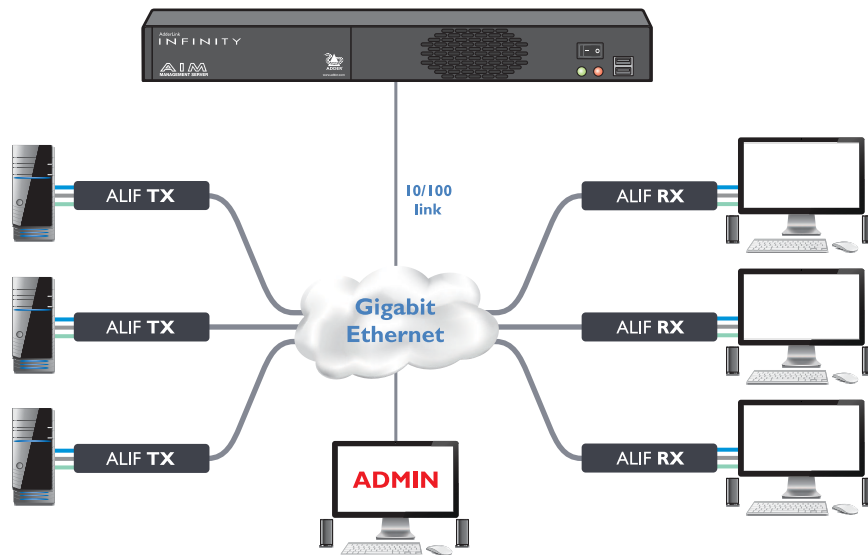

The A.I.M. server connects to your network and provides administrative control over the various AdderLink Infinity transmitters, receivers and their users.

Note: Although the AdderLink Infinity units require Gigabit Ethernet connections, in its administrative role, the A.I.M. server requires only a 10/100Mbps connection to the network.

The A.I.M. server is supplied pre-loaded and is straightforward to deploy, requiring only a network connection and a power input to begin operation.

All configuration of your AdderLink Infinity transmitters (channels), receivers and users are performed using the intuitive A.I.M. browser interface via a network connected computer.

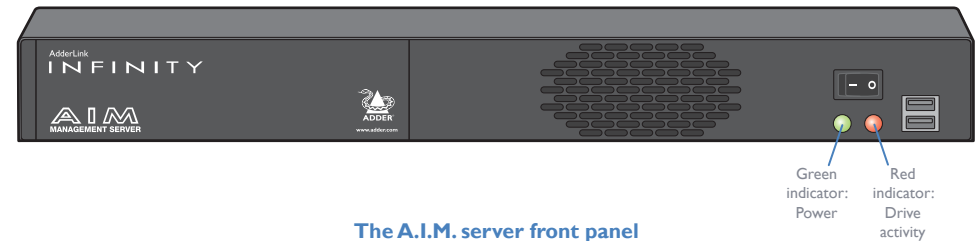

The A.I.M. server front panel

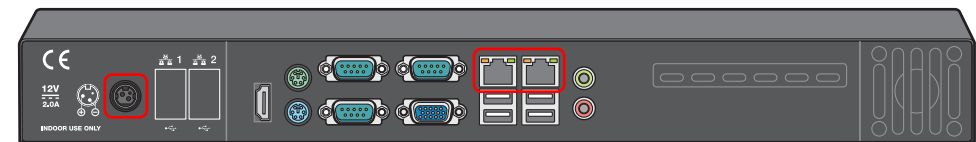

The A.I.M. server rear panel.

In normal use only the network and power connectors are used (ringed in red).

Please see the section [Basic steps for a new configuration](#) for assistance with creating A.I.M. installations.

A.I.M. BASICS

Channels

Think of a channel as a ‘virtual transmitter’. It is virtual because the video, audio and USB streams of a channel do not necessarily have to originate from the same physical transmitter unit, although in most cases they will. For instance, you could arrange for video and USB streams to be received from one host computer, while the audio stream came from an alternative source. Alternatively, two channels could be configured for the same host computer, each with different access rights to suit particular situations.

Groups

In order to accommodate potentially large numbers of users and devices, A.I.M. uses a system of groups: User Groups, Receiver Groups and Channel Groups. Groups allow the administrator to apply collective settings to all members and also to take full advantage of *Inheritance*. Inheritance allows members of a group to benefit from settings and permissions made within other groups to which their group is linked. This saves administration time because members do not need to be individually altered. For instance, if Sam is in User Group 1, all Channels accessible to User Group 1 will be available to Sam.

User types

This guide refers to the two main categories of users involved with the A.I.M. system:

- An **Admin (administrator) user** accesses the A.I.M. system via a network-linked computer running an Internet browser. Once the necessary username and password have been entered, Admin users can make changes to the operation of the A.I.M. system.
- A **Regular user** has a keyboard, video monitor and mouse (plus speakers where appropriate) attached to an AdderLink Infinity receiver unit and can access one or more computers that are linked to AdderLink Infinity transmitters. The AdderLink Infinity receiver provides an [On-Screen Display](#) (OSD) that lists all accessible computers and allows easy access to them.

Security

Security considerations form a major part of A.I.M. operation, ensuring that users have rapid access only to the systems for which they have permission. At its core, A.I.M. manages an important three-way relationship between the users, the AdderLink Infinity receiver(s) and the channels from the host computers.

The diagram shows a representation of the three-way relationship which exists between users, receivers and channels.

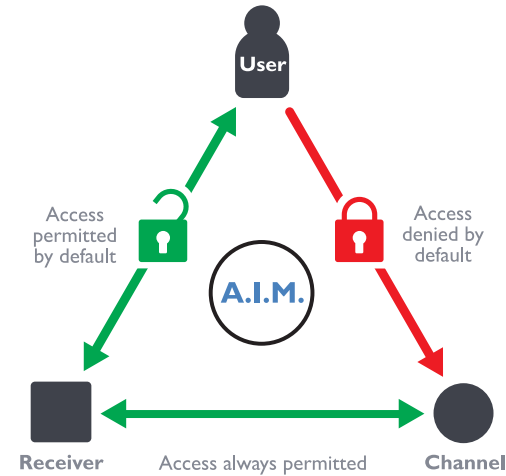

To successfully gain access to a channel:

- **The user requires permission to use the receiver,**
- **The receiver requires permission to connect with the channel,**
AND
- **The user must have permission to access the channel.**

In most cases, the need for three access permissions per connection is unnecessary and raises administration overheads. Hence, by default, A.I.M. grants open access for the user to the receiver and the receiver to the channel while restricting the final, most crucial piece of the puzzle. For those who require it, the lock upon the user to receiver stage can be applied individually or globally.

See [Permissions](#) on the next page for more details.

continued

Active Directory

To streamline administration even further, A.I.M. supports Active Directory. By synchronizing with an LDAP/Active Directory server, details of users (including their usernames and group memberships) can be securely synchronised from existing databases in order to both minimize the initial configuration as well as streamline ongoing updates.

A.I.M. interface

A.I.M. appears in two main ways depending on whether you are an administrator or a regular user.

- For administrators, full access to the AdderLink Infinity Manager Suite is granted. This comprehensive application shows eight main tabbed areas: [Dashboard](#), [Channels](#), [Receivers](#), [Transmitters](#), [Servers](#), [Users](#), [Presets](#) and [Statistics](#), each of which contains numerous related pages of settings and options. The Dashboard provides a central location from which the administrator can view overall operation, make various changes, database backups and also upgrade the firmware of any linked AdderLink Infinity unit.
- For regular users, an efficient page layout provides [a list of all channels](#) for which you have permission to visit. Against each selectable channel name and description, a series of icons provide clear feedback about current availability.

Permissions

Permissions exist between Users, Receivers, and Channels.

By default, all users are granted permission to access ALL receivers.

By default, all receivers have permission to connect to ALL channels.

As shown in the introductory diagram, the missing part is the permission for a user to access each channel.

Permissions between a user and a receiver can be applied in any of the following ways:

- User → Receiver
- User → User Group → Receiver
- User → User Group → Receiver Group → Receiver
- User → Receiver Group → Receiver

Thus, a very indirect way of granting permissions could be:

- UserI is in UserGroupI,
- UserGroupI has access to ReceiverGroupI,
- ReceiverGroupI contains ChannelI,
- Therefore, UserI has access to ChannelI indirectly.

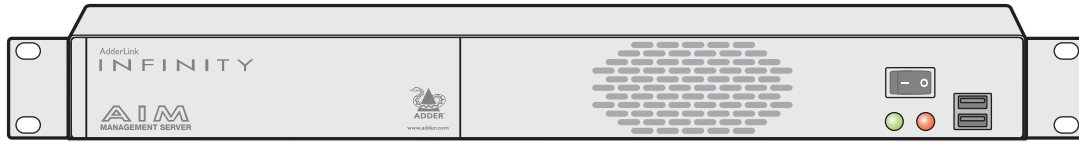

**A.I.M. server unit
with integral rack brackets**

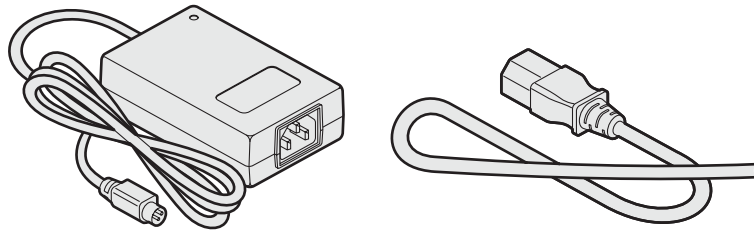

**12V, 5A Power supply plus
country-specific mains cable**

**Replacement power adapter
with locking connector**

Part number: PSU-IEC-12VDC-5A

Country-specific power cords

- CAB-IEC-AUS (Australia)
- CAB-IEC-EURO (Central Europe)
- CAB-IEC-UK (United Kingdom)
- CAB-IEC-USA (United States)
- CAB-IEC-JAPAN (Japan)

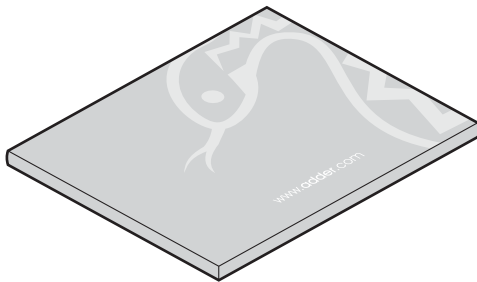

Information wallet
containing:
Four self-adhesive rubber feet
Safety document

CONNECTIONS

The A.I.M. server unit is supplied fully pre-loaded and permits no local user interaction. All configuration takes place remotely via the network connections and as a result only two connections are required: Network and power.

Note: If an existing A.I.M. server must be replaced, follow the important advice given within [Appendix C \(Swapping out an A.I.M. server\)](#).

Note: The A.I.M. server is supplied with the front panel USB connections blanked off. There is no need to connect a keyboard or mouse to the unit as configuration takes place across the network connection.

Network connections

The A.I.M. server has two network connections on the rear panel: port **1** on the left and port **2** on the right. These allow the unit to be connected to internal and external network connections (respectively) as required. The external network connection allows admin users located away from the internal network to be able to login. Network port 2 supports DHCP, however, port 1 does not and needs to be configured manually.

To connect the internal IP network port

- 1 Run a category 5, 5e or 6 link cable from the appropriate hub or router to the A.I.M. server unit.
- 2 Connect the plug of the link cable to the left IP port (1) on the rear panel of the A.I.M. server unit.

Category 5, 5e or 6 cable
from LAN / network switch

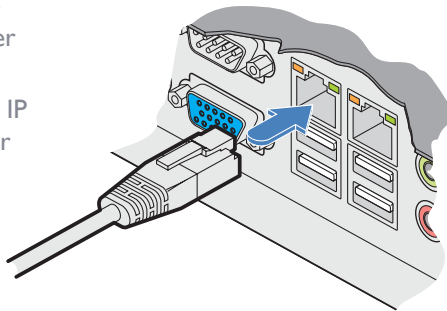

Note: The precise operation of the two ports are determined within the A.I.M. server Management Suite, particularly the [Dashboard > Settings > Network](#) page.

Power supply connection

IMPORTANT: Please read and adhere to the electrical safety information given within the [Safety information](#) section of this guide. In particular, do not use an unearthed power socket or extension cable.

Note: The A.I.M. server can also be powered from the optional RED-PSU managed power supply system using a VSC 48 cable.

To connect the power supply

- 1 Attach the output connector of the power supply to the power input socket on the left side of the rear panel.

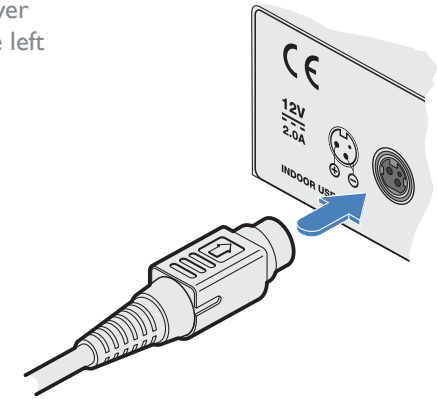

- 2 Connect the main body of the power supply to a nearby earthed mains outlet.

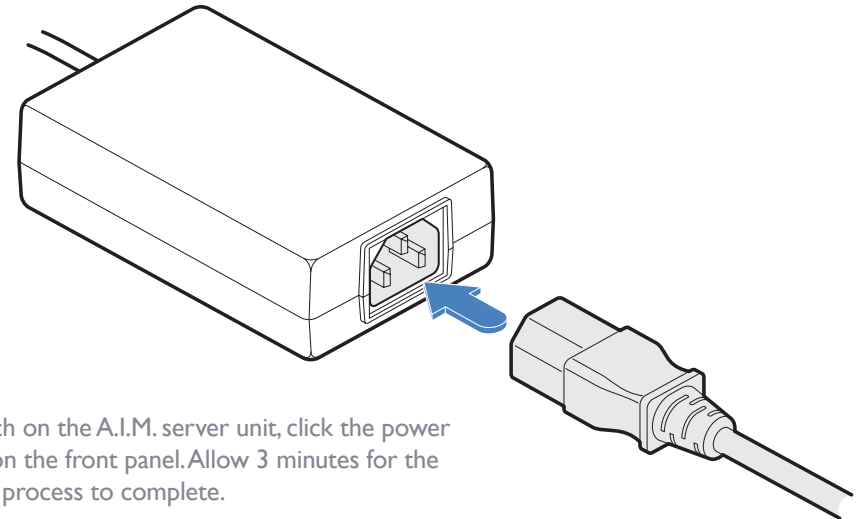

To switch on the A.I.M. server unit, click the power switch on the front panel. Allow 3 minutes for the booting process to complete.

INSTALLATION REQUIREMENTS

- The minimum permissible firmware versions for ALIF units linked with the A.I.M. server depend upon the firmware version that is running on the A.I.M. server itself:
 - A.I.M. server: v4.0 Attached ALIF endpoints: v3.5 (minimum)
 - A.I.M. server: v4.1* Attached ALIF endpoints: v4.1 (minimum)
 - A.I.M. server: v4.2* Attached ALIF endpoints: v4.2 (minimum)
- * *A.I.M. servers with firmware version 4.1 or above no longer support the original ALIF1000.*
- On the network switch(es) that have A.I.M. server(s) attached, ensure that the [portfast](#) option is enabled on each port to which an A.I.M. unit is connected. Where portfast is not enabled, if a second A.I.M. is added for redundancy, this could result in a mis-configured back up server.
- If an existing A.I.M. server must be replaced, follow the important advice given within [Appendix C \(Swapping out an A.I.M. server\)](#).
- When configuring the installation for multicasting (and to improve overall performance), the network switch(es) being used must support a minimum of [IGMP v2 snooping](#). For faster performance use switches that support IGMP v3.
- In order to display video resolutions that use a horizontal video resolution of 2048 pixels, the network switch must have support for [Jumbo packets](#).
- Please also see [Appendix A - Tips for success when networking ALIF units](#).
- This unit should always be installed in suitable a 19” rack space, it is not suitable for standalone desktop use.

MOUNTING THE A.I.M. SERVER

The A.I.M. unit is designed to be easy to mount within a standard 19" rack, it is NOT suitable for free standing use on the desktop. The server chassis requires just a 1U space within the rack.

To mount the A.I.M. server within a rack mount

- 1 Slide the A.I.M. server into the vacant 1U space within the rack mount.
- 2 Secure each bracket to the rack using two screws per side as shown below:

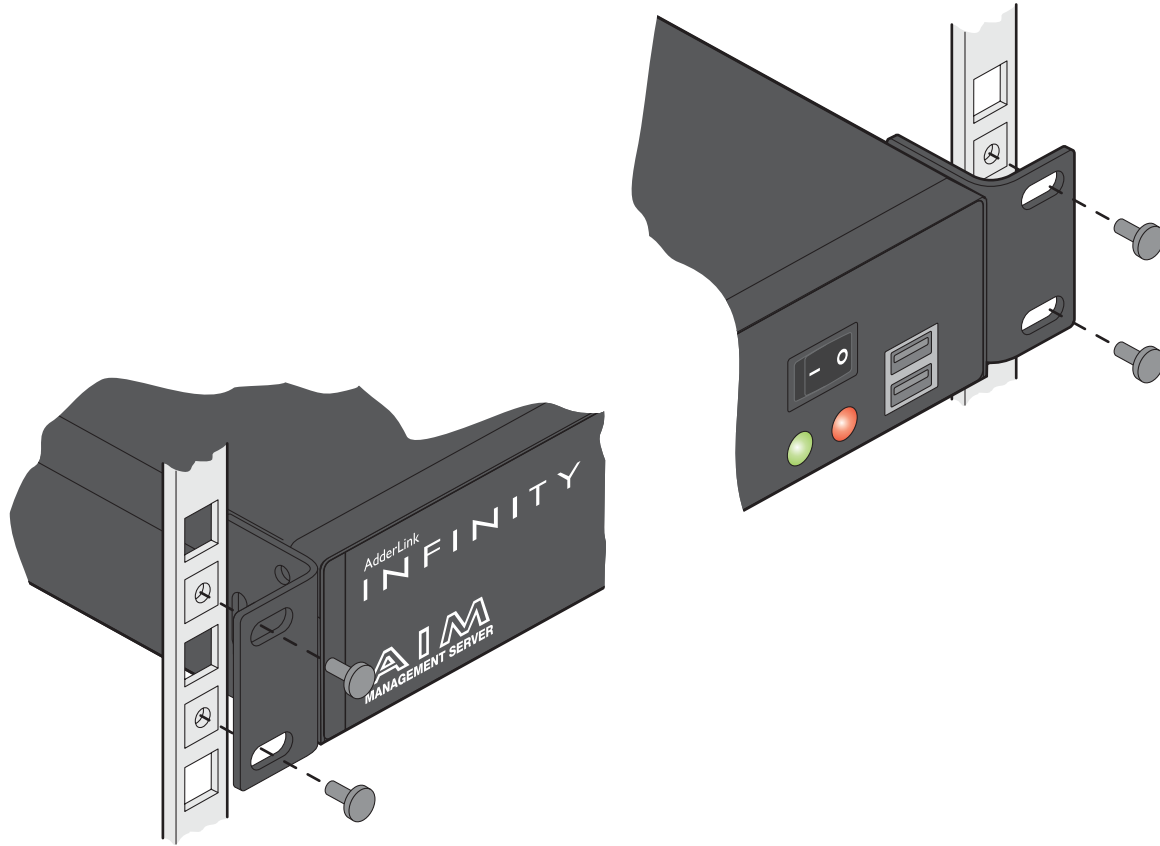

This section covers configuration of the AdderLink Infinity Manager Suite for administrators. For details about the regular user interface, please see the [Operation](#) section.

SUPPORTED BROWSERS

The A.I.M. admin interface requires an A-grade browser with Javascript enabled.

The list of supported browsers is as follows:

- Google Chrome
- Firefox
- Internet Explorer
- Safari

Note: For best results always use the latest versions of the supported browsers.

LOGIN FOR ADMIN USERS

- 1 Ensure that the A.I.M. server is powered on (allow 3 minutes before accessing).
- 2 Using a computer located anywhere within the local network open a web browser (see Supported browsers list opposite) and enter the default IP address for the A.I.M. server: **169.254.1.3**

The Login page will be displayed:

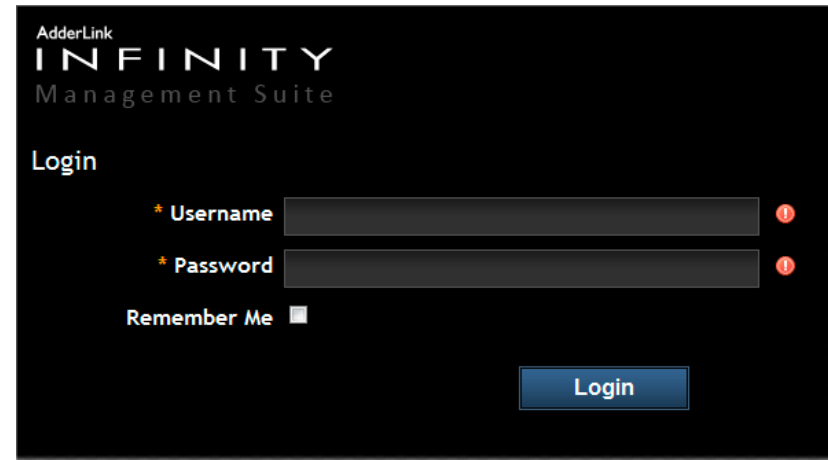

- 3 Enter your Username and Password and click the Login button.

The default username is **admin** and the default password is **password**.

You are strongly recommended to change the default admin password as one of your first actions: Go to *Dashboard>Users*. Click on the furthest right icon in the admin row (configure users) and change the password for the admin user.

If you check the **Remember Me** box, a cookie will be stored on the computer, allowing you to access the admin section without having to log in each time. The cookie will survive for up to the *AIM Admin Timeout* period. If you do not check the Remember Me box, you will remain logged in only for the duration of your browser session.

- 4 Continue to the section [Important first configuration steps](#) on the next page.

IMPORTANT FIRST CONFIGURATION STEPS

There are several important configuration steps that must be carried out when starting a new A.I.M. server for the first time.

To determine the A.I.M. server's rôle and main IP address

- 1 Switch on and log in to the A.I.M. server; you will be presented with the Servers page.
- 2 Within the Server page, choose the Rôle of this new A.I.M. server:
 - *Solo* - This will be the only A.I.M. server on the network (with no redundancy and failover), or
 - *Primary* - This server will be used as part of a redundant cluster of A.I.M. servers, where it will be the main server used to manage the ALIF units.
- 3 Click the Save button. You will next be presented with the [Dashboard > Settings > Network](#) page.
- 4 Within the *Ethernet Port 1* section half way down the page, change the default *AIM IP Address* (and *Netmask*) options to settings that suit your network configuration and which will be used henceforth for this server.

Note: The AIM IP Address and Netmask can only be set up once and you will NOT be able to perform any other actions, or navigate to any other pages, within the A.I.M. admin interface until you have set and saved it.

IMPORTANT: Once set, the Ethernet Port 1 AIM IP Address and Netmask settings must NOT be changed during operation of the system. Changing these will invalidate the system's security and require intervention from the Adder technical support staff to restore to a working state.

- 5 You can now either:
 - Continue with other settings on the same page (See *To choose how IP addresses are applied to ALIF units* right), or
 - Click the Save button. After a short delay the web browser will automatically redirect itself to the new IP address so that you can continue administering the A.I.M. server.

Note: Ensure that your computer can view the new IP address, otherwise the A.I.M. server will appear to be offline. Depending on your network configuration and that of the computer, you may need to change the computer's configuration to be able to see A.I.M. server's new network address.

To choose how IP addresses are applied to ALIF devices

- 1 Login again to the A.I.M. server and choose the [Dashboard > Settings > Network](#) page.
- 2 Depending upon the level of your purchased license, the *Subnet Operation* option may, or may not, be presented at the top of the page. If the *Subnet Operation* option is present, you have the following choices:
 - *Off* - A.I.M. can administer a single subnet and will use its own DHCP (Dynamic Host Configuration Protocol) server to automatically assign IP addresses to new ALIF devices, drawing upon a pool of spare addresses defined by you.
 - *On* - A.I.M. can administer devices across multiple subnets, but will rely upon an external DHCP server to assign valid IP addresses to new ALIF devices.

Note: If the Subnet Operation option is not present, the A.I.M. server will operate as per the Off setting described above. For details about upgrading your license, see [Appendix D](#).

- 3 If you chose the *Off* setting (or if *Subnet Operation* is not part of your license), you now need to define the boundaries of the IP address pool that will be used by the internal DHCP server. Enter valid start and end addresses to the *IP Pool Lower Limit* and *IP Pool Upper Limit* options.

Note: If you chose the On setting, you will need to perform a similar operation within the external DHCP server.

For further details about other options within this page, see [Dashboard > Settings > Network](#).

- 4 When all options have been set, click the Save button.

IMPORTANT

Note: If an existing A.I.M. server must be replaced, follow the important advice given within [Appendix C \(Swapping out an A.I.M. server\)](#).

ADDING ADDERLINK INFINITY UNITS

When new ALIF transmitters and receivers are added to a network, they are designed to automatically announce themselves* to the A.I.M. server. Once the A.I.M. server receives their announcement(s), the ALIF units will be added to the administrator's view of the [Dashboard](#). From here you can then begin to configure each new ALIF unit.

*ALIF units can be configured either from their own browser-based configuration utility or via the A.I.M. server. Once an ALIF unit has been configured in one way, it cannot be reconfigured using the other method without undergoing a factory reset. This policy is in place to help prevent accidental overwriting of configurations. It also means that once an ALIF unit has been locally configured, it will not announce itself to the A.I.M. server upon being added to a network. Please see right for details about resetting an ALIF unit.

When new ALIF devices announce themselves, depending upon how it was initially configured (see [Important first configuration steps](#)), the A.I.M. server will either assign IP addresses to new ALIF units automatically, or will rely upon an external DHCP server to do the same. Either way, providing each ALIF device is not already configured and announces itself to the A.I.M. server (see below for potential issues that can prevent this), they will be automatically provided with a suitable IP address so that they may operate within the network. Once ALIF units have been added, you can use the A.I.M. server [Dashboard](#) to select and further configure any or all of them.

If an ALIF unit is not located

There are several reasons why an ALIF unit might not be located by A.I.M.:

- The ALIF unit has been locally configured or is otherwise not using its factory default setting. Try performing a factory reset on an ALIF that is not being located.
- The ALIF unit is not located in the same Ethernet segment as the A.I.M. server. Double check connections and move units where necessary, so that all reside within the same Ethernet segment.
- There is a potential cabling problem between the ALIF and A.I.M. units. Check and where necessary, replace faulty cables.

AdderLink Infinity manual factory reset

Where a previously configured ALIF unit is being added to a network for control by an A.I.M. server, you can use this method to reset the unit to its default configuration.

To perform a manual factory reset

- 1 Remove power from the ALIF unit.
- 2 Use a narrow implement (e.g. a straightened-out paper clip) to press-and-hold the recessed reset button on the front panel. With the reset button still pressed, re-apply power to the unit and then release the reset button.



Use a straightened-out paper clip to press the reset button while powering on the unit

After roughly eight seconds, when the factory reset has completed, five of the front panel indicators will flash for a period of three seconds to indicate a successful reset operation.

Further information

Please also see:

- [Appendix A - Tips for success when networking ALIF units](#)
- [Appendix B - Troubleshooting](#)
- [Appendix C - Redundant servers: Setting up and swapping out](#)
- [Appendix D - Upgrade license](#)
- [Appendix E - Glossary](#)
- [Appendix F - A.I.M.API](#)
- [Appendix G - DHCP server requirements for ALIF support](#)
- [Appendix H - Technical specifications](#)

THE DASHBOARD TAB

The Dashboard is your main point of contact for checking and changing the general status of all A.I.M. operations.

Click the DASHBOARD tab to view its initial home page.

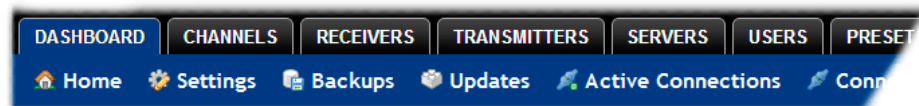





The various other Dashboard pages (e.g. Settings, Backups, Updates, etc.) are selectable within the blue section located just below the tabs.

Dashboard > Home

- **Shutdown button** - Allows the admin user to shut down the A.I.M. server. The OSD will no longer work on Receivers. The A.I.M. server will need to be manually started again when next required.
- **Restart** - The admin user can reboot the A.I.M. server. The [OSD](#) and admin section will be unavailable while the server is rebooting. This currently takes about 75 seconds.

Within the Home page*, the different sections provide a variety of information:

- **Warning messages** - Live alerts are displayed concerning any devices that are offline, rebooting, recently added or unconfigured.
- **Latest Active Connections** - shows the five most recent active sessions, detailing for each: When the session started; which user/receiver/channel is involved; the connection type (icons show audio, video, serial, USB, exclusive) and IP addresses in use. The red unplug icon on the far right allows the admin user to disconnect a connection.
- **Event Log** - shows all actions performed by the admin or end-users within the A.I.M. system. See also the [Event Log page](#).
- **Latest Channels Created** - shows the last five channels created within the A.I.M. system. A channel is created by default when a new transmitter is added and configured. The edit icon next to a channel allows the admin user to configure the channel.

- **Latest OSD Logins** - shows the last five users who logged in (either to the A.I.M. admin or at an AdderLink Infinity Receiver).
- **Latest User Registrations** - shows the last five users added to the A.I.M. system, with a link to edit the user's details/permissions.
- **Latest Channel Changes** - shows the last five users who changed a channel, either while using the on-screen display (OSD) at an AdderLink Infinity Receiver, or via the A.I.M. admin control panel.
- **Latest Receivers Added** - shows the last five receivers to be added and configured within the A.I.M. network. Click  to configure a receiver; click  to connect to a channel; or click  to disconnect an existing connection.
- **Latest Transmitters Added** - shows the last five transmitters to be added and configured within the A.I.M. network. Click  to configure a transmitter.

*The Home page is auto-refreshed every ten seconds to ensure that the latest information is always available.

Dashboard > Settings

Click the **Settings** option below the Dashboard tab.

The Settings section contains global configuration options for the A.I.M. system and is divided into eight pages, each accessible by clicking the relevant button located below the blue options bar:



General • Transmitters • Receivers • Servers • Network • Time • Mail • Active Directory

For configuration options that affect individual receivers, users channels, etc., see the sections dealing with those tabs.

Dashboard > Settings > General

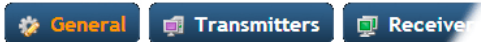

Receiver OSD Timeout

Determines the time period of inactivity within the OSD after which a standard user will be automatically logged out.

A.I.M. Administrator Timeout

Determines the time period of inactivity within the A.I.M. config pages after which an admin user will be automatically logged out.

Anonymous User

Determines which user is shown in the log when a receiver is set to 'No login required'.

Hide Dormant Devices

If enabled, devices that have been offline for more than 24 hours will be hidden.

Grant All Users Private Access

Determines whether a user can connect to a channel privately and thus prevent any other users from simultaneously connecting to that channel. If not set, users can only connect in Video-Only mode or Shared mode. Settings that are applied specifically to a user will override settings applied to user groups they're in, which in turn override this global setting.

Note: If a user has Private Access mode granted or NOT granted at user level, then it doesn't matter what settings there are above (usergroups or global).

- If a user is set to inherit "Allow Private?" mode from their user groups, if any one of their user groups has "Allow Private?" mode granted, then the user will have it granted, even if the rest of the user's usergroups have private mode not granted.
- If a user is set to inherit "Allow Private?" mode from their user groups, and one of the user groups is set to inherit from the global setting - if that global setting is "Allow Private?" mode, then effectively the user group is "Allow Private?" mode so the user will be allowed private mode.

Grant All Users Remote OSD Access

If enabled, allows receivers to be switched remotely from another receiver's OSD menu.

Allowed Connection Modes

Determines the global setting that will be applied to all new channels concerning connection modes. The setting made here is only applied as a default and can be overridden at the channel level, where necessary. Options are:

- **Video-Only:** Allows users only to view the video output, the USB channel is denied.
- **Shared:*** Allows users to control a system in conjunction with other users.
- **Exclusive:** Grants exclusive control to one user while all others can simultaneously view and hear, but not control, the output.
- **Private:** Allows a user to gain private access to a system, while locking out all others.

Note: By default, all new channels are set to inherit this global value. So it's easy to change all channel connection modes simply by changing the global setting. If a channel has its own setting, the global setting has no effect on that channel.

** If USB is disabled, Shared mode will not be available as an option.*

Rows per page

The number of rows to display in all paginated tables in the admin section.

Locale

Determines the language shown on the OSD menus of the receivers. Note the admin configuration web pages remain in English.

Debug Level

This allows information to be collected for diagnostic purposes. Do not use the full level unless advised by an Adder FAE.

API Login required

If enabled, the anonymous use of the A.I.M. API will be disallowed.

Anonymous user

Determines the user permissions to be used when the API is accessed without logging in.

Supported Devices - Indicates the limits of the current license.

Upgrade License - (see [Appendix D](#) for details)

Displays information about the number of devices that can be connected to the A.I.M. server.

Licensed Features - Displays the level of operation permitted under the current license. Click view/change to see more detail and gain a unique identifier that can be declared to Adder when upgrading a license.

This page applies a standard global configuration to all transmitters.

Magic Eye

Determines whether the Magic Eye feature should be enabled on ALIF (1002T, 2002T, 2020T or 2112T models only) transmitters. Magic Eye works to overcome the issues with increased bandwidth usage caused by ‘dithering’ techniques used on some computers, such as Apple Macs. See the ALIF dual user guide for more details.

DDC

Determines whether video configuration details should be harvested from connected display screens or a static fixed EDID report should be used. Care must be taken when selecting a Dual Link Video resolution as only ALIF dual units support a Dual Link Video resolutions. In the case of a Dual Link EDID being set in the Global settings, no EDID will be set on Video port 2 of the ALIF dual transmitters.

EDID optimisation

When this option is ticked, the Transmitters will compare the native resolution settings of their monitors when switching. If the monitor has the same native resolution as the previous one, the new EDID is not sent to the graphics card. This speeds up switching as the graphics card does not have to go through a hotplug detect routine when a new receiver is switched to that channel. If the new receiver has a monitor with a different native resolution, then the EDID will be updated to allow for a change in video mode.

Hot Plug Detect Control

Determines whether to enable hot plug detection for monitors. By default this is enabled.

Hot Plug Detect Signal Period

By default this is set at 100ms, which is sufficient for most graphics cards. Occasionally it may be necessary to adjust this. An Adder FAE will advise if necessary.

Background Refresh

The number of frames between sending an entire frame of video data. Setting this to a longer period or disabling this will reduce the bandwidth required.

Compression Level

The newer AFZ+ codec compliments the existing AFZ codec by providing greater compression for increased speed where pixel perfect results are not the primary focus. The transmitter video configuration page allows you to choose the required compression mode. Choices are:

- ‘Pixel perfect’ - only uses pixel perfect AFZ,
- ‘Adaptive’ - guarantees frame rate, builds to pixel perfect,
- ‘Smoothest video’ - forces the maximum compression, or
- ‘Advanced’ - allows you to choose the mode:
 - 1 ‘AFZ only (pixel perfect),
 - 2 ‘AFZ+ Minimum compression’,
 - 3 ‘AFZ+ Middle compression’, or
 - 4 ‘AFZ+ Maximum compression’.

USB Speed

Select Low/full speed or High speed USB operation.

USB Hub Size

Select either a 13 or 7 port USB hub. This determines the number of USB devices that can be connected to a single Transmitter.

Note: It is not possible to reserve USB ports on the transmitter when used with A.I.M.

Enable Dummy Boot Keyboard

It is often necessary to have a keyboard reported at start up. This setting means that a “Virtual Keyboard” is always reported to the USB host. It may be necessary to disable this for use with some KVM switches.

Reserved USB ports

This setting lets you set aside a specific number of USB ports (up to 8) on the transmitter that can be made available for certain USB devices which require a quirk setting under advanced USB features, connected to a receiver.

Note: This setting can only be applied globally it is not found with individual transmitter configurations because all receivers need to know how many USB ports are available for the advanced USB features.

Serial port options

These allow you to match the serial configuration being used by the attached PC host.

This page applies a standard global configuration to all receivers.

Hotkey settings

The first few rows determine the Hotkeys that can be used to invoke certain functions. It is possible to select mouse keys to perform these functions, though it is not possible to use both mouse switching and a hot key combination. It is also not possible to mix left and right function keys. Left Ctrl and Left ALT are the default settings.

Login required

Determines whether it is necessary to log into the receiver.

Enable Receiver OSD Alerts

Determine the required setting for pop up OSD alerts: No or Yes.

Video Compatibility Check

This reads the EDID from the attached monitor and determines whether the monitor is capable of displaying the selected video mode before connecting a channel. This prevents the receiver showing a black screen and the user being locked out because a dual link resolution has been selected to display on a single link monitor.

Force 60Hz

If enabled, the receiver frame rate is held at 60Hz regardless of the video input frame rate. The Video Switching options (below) cannot be altered when this option is enabled.

Video switching

Provides two options for video switching:

- *Fast Switching* (default state) - Retains the same frame rate (at either 50Hz or 60Hz) depending upon which video resolution was displayed first.
- *Match Frame Rate* - Follows the source frame rate and will change the frame rate every time this changes even if the video resolution doesn't change. If you have one receiver switching between 1920x1080@60Hz and 1920x1080@50Hz then this setting will change the frame rate from 60Hz to 50 Hz every time that you switch.

Receiver Keyboard Country Code

Select the country code of the keyboard connected to the receiver.

Audio Input Type

Select the required audio input type.

USB Settings

HID only

If enabled, allows only HID (mice and keyboards) devices to be connected to the receivers.

Disable Isochronous Endpoint Alerts

When an isochronous USB device is connected to the receiver there will no longer be a warning message. ALIF units do not support isochronous devices.

Enable Isochronous Endpoint Attach

Some USB devices combine many USB devices behind a USB hub. e.g a keyboard with audio support. By enabling this option, devices will be allowed to connect to ALIF receivers, however, the isochronous part (e.g. the audio component) of the devices will not work.

Advanced Port

This section allows you to determine USB port behaviour for use with certain USB devices.

The default is no reserved ports, Merging enabled and no feature code (or Quirk) set. It is recommended that these are left at the default settings and are only changed under advice from an Adder FAE.

For each of the four USB ports on the receiver, certain rules can be applied depending upon the USB device connected.

If you have reserved USB ports on the transmitter, you can select which USB port to use for a particular device.

You can turn off USB merging for a particular port. This will slow down switching as the USB device will be enumerated every time that you switch.

You can also enter an advanced feature if it is necessary for your USB device. The drop down lists the feature codes for some known USB devices. Otherwise please contact your local FAE for advice.

This page is used to configure redundant operation for the A.I.M. servers.

It is now possible to place two A.I.M. boxes on the same subnet. One A.I.M. box is the Primary (or Master) the other is the secondary (or Slave). If the Primary server fails for any particular reason then the Secondary will take over until the Primary is repaired. This functionality is only possible if the licenses of the both A.I.M. units match. Both A.I.M. units need to be able to control the same number of endpoints.

Primary Timeout

The time (in seconds) for the Primary server to be unavailable before the secondary takes over.

Quiescent Timeout

The time after which an inactive (*Quiescent*) server is assumed to have disappeared.

Backup Check Interval

The interval between the Primary server querying its backups to determine if they are all on-line.

Backup Timeout

The period of time that a backup server can be off line or uncontactable before it is treated as a failed server.

Require Authentication

If set to 'Yes', then a new, unconfigured A.I.M. server will be unable to join the cluster automatically; it's behaviour will be to report itself as unconfigured and quiescent, and request a password. Entering the cluster password will then allow it to join the cluster as a Backup.

Cluster Password

This is the password that is used for A.I.M.-to-A.I.M. https queries, if the *Require Authentication* option is enabled.

This page applies global network parameters to the A.I.M. network.

Require SSL for Web

If set to yes, a certificate needs to be downloaded and all connections will then take place using HTTPS:// connections rather than the default HTTP:// connection types.

IP Pool Lower/Upper Limits (not shown in multi-subnet mode)

When the A.I.M. server is used in single subnet mode, these two fields are used to define the range (pool) of IP addresses that the A.I.M. server can automatically assign to new ALIF endpoint devices. The A.I.M. server contains its own DHCP server with which it applies the available IP addresses to ALIF endpoint devices.

When used in multi-subnet mode, the internal DHCP server with the A.I.M. is disabled and instead the A.I.M. server will rely upon an external DHCP server to provide valid IP address details.

Multicast IP Base

The start address for the multicast IP addresses to be used. Multicast IP addresses are in the range 237.1.1.1 to 239.255.255.255. This setting lets you adjust this range of IP Multicast addresses. It is important to allow sufficient addresses for your system. For instance, if the multicast IP address base was set to 239.255.255.252 there would only be 4 multicast addresses available.

Always Multicast

Determines whether multicast addressing is always used for video and audio streams. This should be used for most installations as it provides the most efficient way to deliver video and audio to multiple destinations.

Separate Device Networks

When this option is set to 'Yes', the ALIF devices within the network will be instructed to promote a further level of network resilience by treating their copper and fiber/teaming connections as independent links via separate switches (in conjunction with dual independent cabling schemes) see the diagram on next page. If one connection route is compromised, the other will continue unaffected. During normal operation, when both connection routes are operating, transfer speeds are boosted by the copper and fiber links working in parallel.

The two Ethernet ports of the A.I.M. server can be connected to the two separate network switches to ensure that A.I.M. control remains in place if one network switch should become unavailable.

Route of Last Resort

This option is appropriate when the A.I.M. server is used in multi-subnet mode. In such cases it is possible that the A.I.M. server is not directly connected to the same sub-network as some or all of the ALIF endpoints. Therefore, it will be necessary for the ALIF unit(s) to communicate back to the A.I.M. server via a gateway device. This option is used to indicate which interface has the gateway configured.

Device Network Port

This option determines the most appropriate mode of redundancy between multiple A.I.M. servers in a cluster. The default setting is 'Port 1' and this is correct for a typical configuration in which the ALIF endpoints and A.I.M. server(s) are all located on one subnet. Alternatively, where A.I.M. servers are linked to two separate subnets, both of which can provide a route from the endpoints, then choose the 'Both' setting.

Gateway IP Address

Defines the IP address of an optional gateway device.

Ethernet Port 1

The primary A.I.M. server Ethernet port can only be configured using a static IP address. Use the three option provided to configure the IP address, netmask and DNS server address.

Ethernet Port 2

The secondary A.I.M. server Ethernet port can be configured to either: gain its details via a DHCP server; use a Static IP address, netmask and DNS server address, or alternatively be set to Bonded operation, whereupon three further Bonding Mode options are displayed:

- **Active-Backup** - This can be used when both of the A.I.M. server's network connections are linked to the same network switch. This option provides a fail-over to cater for the possibility of hardware failure or connectivity failure between the A.I.M. server and the switch.

In this mode, one of the A.I.M. server's network ports will be active while the other remains dormant. If the active port experiences a failure, such as a loss of connection, its configuration is automatically transferred to the secondary port. Once the original primary port resumes connectivity, this will become the backup and be placed into a dormant mode.

- **Broadcast** - This option would be used when the twin ports of the A.I.M. server and all attached ALIF devices are split between duplicate networks:

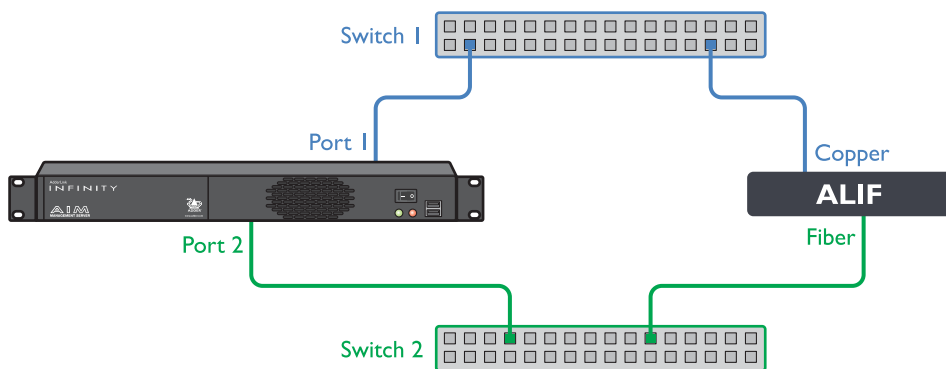

The 'Separate Device Networks' option mentioned earlier would be enabled on the A.I.M. server and the respective network connections on the endpoints are connected accordingly (e.g. copper to copper on only switch 1 and SFP to SFP only on switch 2).

In Broadcast mode, both of the A.I.M. server network connections mirror each other, i.e. duplicate network traffic is sent out on both connections. It is assumed that the connected devices will only listen to the network traffic intended for themselves and *drop/ignore* all other traffic intended for other devices. This mode is robust but inefficient because half of the packets are discarded.

- **802.3ad** - This mode uses a similar topology to *Active-Backup*, (i.e. both network ports connected to the same switch) but has two important differences: Both of the A.I.M. server network ports are used simultaneously, and the network switch must support LACP (*Link Aggregation Control Protocol*).

The A.I.M. server will 'merge' (*aggregate*) the two connections and treat them as one. The only exception to this would be on 'multi-Subnet racks' where it would be possible to have each network connection on different switches.

This mode provides the benefit of increased bandwidth availability between the A.I.M. server and the network, but also provides a layer of redundancy. If one of the network connections is lost, the remaining connection would take over until the link is restored.

The network traffic is not split on a packet by packet basis between the connections; it operates on a connection basis. When a connection is established between the A.I.M. server and one of the ALIF endpoints, this would travel via one port. When a second connection to another endpoint is established, this could use the same port or it may use the other. There is no order to which network port is used for any connection.

Note: When changing between bonded and any other mode, a warning message will be displayed and, when the Save button is clicked, will cause the A.I.M. server to be rebooted.

Syslog Enabled

Determines whether Syslog should be used to record log data to an external Syslog server.

Syslog IP Address

The address of the external syslog server.

SNMP

This option allows the A.I.M. to connect to an external SNMP server. If SNMP is enabled, there are three connection modes:

- Authentication + privacy
- Authentication only
- No authentication

There are two authentication types SHA or MD5 and two Privacy types AES or DES. The MIB file can be downloaded from <http://<IP>/AIM-MIB.txt>

Dashboard > Settings > Time

[Network](#) [Time](#) [Mail](#)

This page deals with all time related settings for the installation and allows up to three external NTP servers to be defined.

NTP Enabled

Determines whether one or more external Network Time Protocol servers should be used to provide timing for the installation.

Server 1 Address

Enter the IP address of the NTP server.

NTP Key Number/NTP Key

If you wish to use Symmetric key authentication for the server, enter an appropriate NTP key number and key.

If you need to add more NTP servers, click the Set option next to the NTP Server 2 or 3 entries.

Time Zone Area and Time Zone Location

Use these entries to pinpoint the current location of the installation.

Dashboard > Settings > Mail

[Time](#) [Mail](#) [Active Directory](#)

This page sets up the email functionality of the A.I.M. server if required. An external Email server is required to sit on the network if this functionality is to be used.

Mail Enabled?

Determines whether the mail features of A.I.M. should be invoked.

SMTP Domain name/IP

Enter the name or IP address of the external SMTP server that will be used to process all outgoing mail.

SMTP Port

Enter the appropriate port on the SMTP server.

Username, Password

Enter the appropriate username and password for access to the SMTP server.

Email Address for Alerts

Enter the email address that will be used to send alert messages.

Dashboard > Settings > Active Directory

[Mail](#) [Active Directory](#)

This page sets up the active directory server, if there is one on your network, and to use active directory to maintain the user database.

AD Enabled?

Determines whether Active Directory features will be used.

Account Suffix

Enter the account suffix for your domain.

Base DN

Specify the base Distinguished Name for the top level of the directory service database that you wish to access.

Domain Controller

Enter the IP address or name of the server that holds the required directory service.

Username, Password

Enter the username and password for the domain account.

Sync Schedule

Choose the most appropriate synchronization schedule, from hourly intervals to daily or weekly.

Dashboard > Backup

You can schedule backup copies of the A.I.M. database (containing all devices, users, channels and logs) to be made on a recurring basis and you can also perform backups on demand, as required.

IMPORTANT: You are strongly recommended to arrange regular scheduled backups of your A.I.M. database. Adder cannot be held responsible for any loss of data, however caused.

Backup Options

Download to your computer: If this option is checked, when you click the “Backup Now” button, the backup file will be saved to the server and then will be presented as a download in your browser, so that you may save a local copy of the backup file.

Email backup: If this option is checked, a copy of the backup file will be sent to the email address specified in the “Email Backup To” field. The backup file will be emailed either when you click “Backup Now” and/or according to the option selected in the Schedule section.

Note: Use of the Email backup option requires a valid email address to be stored within the [Dashboard>Settings](#) page.

Note: Emailed backups are encrypted, and these backup files are automatically decrypted by the A.I.M. server when they are used.

Schedule: Determines how often a backup should be created. There are set periods for the various options:

- Hourly backups are executed on the hour (or quarter past).
- Daily backups are executed at 2am (or quarter past).
- Weekly backups are executed every Sunday at 3am (or quarter past).

Restore from Server

All backups (whether initiated manually or by schedule) are saved on the server together with a time-stamp of when the backup was run. If required, you can select a previous backup and restore its contents. Alternatively, you can download the backup file to another location.

IMPORTANT: It is advisable to make a backup of the current state of the A.I.M. system before restoring a previous backup. Restoring the contents of a backup file will overwrite ALL data in the A.I.M. system, with the data within the backup file. This includes configured devices, channels, users, connection logs and action logs.

Restore from File

Use this option to upload a backup file that you have previously downloaded or received by email. This will overwrite the contents of the current A.I.M. system therefore it is advisable to make a backup of the current state of the A.I.M. system before restoring a previous backup.

Archive Log to CSV File

You can archive connection or log data to a CSV file and, at the same time, remove old log data from the database.

Click “Archive” to save a CSV file to the server.

Download CSV Archive

You can download any CSV archive that was created in the archive step (described above) by selecting from the archives saved on the server.

The CSV archive can be opened in Microsoft Excel (or similar) to perform detailed analysis of actions and connections within the A.I.M. system.

Dashboard > Updates

Upgrade AIM Software

This option allows you to upgrade (or downgrade, if required) the A.I.M. server firmware while preserving all configuration data. Firmware files are encrypted and digitally-signed for A.I.M.-server integrity.

Please see [Upgrading \(or downgrading\) A.I.M. firmware](#) on the next page

Note: There is no longer any support for ALIF1000 units within A.I.M. firmware version 4.1 onwards.

Reset AIM Configuration

This option can be used to reset A.I.M. to its initial configuration or a previous upgrade. When the A.I.M. server is reset, all devices, channels, presets, users, groups and logs will be removed. *Note: You are recommended to take a backup onto an external device before starting the upgrade process.*

If one or more previous upgrades have been installed on this system, you will be given the option to choose either the original factory image or the last upgrade image. They will be listed by version number - click the appropriate radio button to select.

Two other options are available within this section:

- *Also reset the server IP address* - When ticked, the IP address will be reset to the default: **169.254.1.3** and you will be reminded to manually navigate to that address.
- *Also delete security certificates and keys* - When ticked, all certificates and keys held within the server will be removed.

When the required options have been chosen, click the **Reset AIM Configuration** button to commence.

Upload New TX/RX Firmware

Allows you to upload a firmware file to the A.I.M. server, which can then be used to upgrade ALIF TX and RX units.

Install Firmware onto Devices

Allows you to determine various upgrade settings and then commence the upgrade process.

Please see [Upgrading ALIF firmware globally](#) >>

Upgrading ALIF firmware globally

This method allows the A.I.M. admin user to upgrade firmware on receivers and transmitters, wherever they are located.

- 1 Use the “Upload New TX/RX Firmware” section to place new transmitter and/or receiver firmware file(s) onto the A.I.M. server. Once uploaded, the stored firmware files are listed within the relevant “Available firmware” drop-down boxes within the sections below.
- 2 Within the “Install Firmware onto Devices” section, choose the Device Version (ALIF standard or dual model), Device Type (RX or TX) and Firmware Type (Main or Backup copies).
- 3 Click the Available firmware drop-down box and select the required new firmware version.

Note: There is no longer any support for ALIF1000 units within A.I.M. firmware version 4.1 onwards.

- 4 Click the “Install” button to apply the chosen firmware to the devices.
- 5 On the right side of the list, you can:
 - Individually select the devices to which the firmware upgrade will be applied by checking the “Upgrade” boxes next to each device, or
 - Use the “Upgrade All” option to apply firmware globally to all devices.
 - You are recommended to tick the “Reboot First” (or “Reboot All First” when using the “Upgrade All” option).
- 6 Click the “Upgrade Selected...” button to create a queue of devices to be upgraded. If there are many devices to upgrade, this may take some time.

The status of devices during the upgrade process should be shown in near-real time on the receivers/transmitters pages and on the device’s own page. The page will show whether the device is still in the queue to be upgraded or if it is in the process of rebooting with the new firmware. Note that the process of applying firmware to a device and enacting a reboot takes several minutes to complete.

Upgrading (or downgrading) A.I.M. firmware

In certain circumstances it may be necessary to upgrade or downgrade the firmware of an A.I.M. unit to take advantage of particular features. The Upgrade AIM Software option changes the firmware without affecting configuration data such as devices, channels, presets, users, groups and logs.

Note: Although configuration details are not affected during the firmware upgrade process, you are recommended to take a backup onto an external device before starting the upgrade process.

Note: When changing the A.I.M. firmware, it will be necessary to reboot the unit in order to apply the changes.

Note: There is no longer any support for ALIF1000 units within A.I.M. firmware version 4.1 onwards.

To upgrade/downgrade the A.I.M. unit firmware

- 1 Download the appropriate firmware file from the Adder website or technical support.
- 2 Visit the Dashboard > Updates page of the A.I.M. unit and within the 'Upgrade AIM Software' section, click the Browse... button to locate the downloaded firmware file.
- 3 When you are ready to proceed, click the Upload button. The file will be uploaded, checked and applied to the secondary partition within the A.I.M. unit. A confirmation message will be displayed and you will also be prompted to reboot the A.I.M. unit.
- 4 When it is appropriate to do so (dependent on the current activity of the A.I.M. unit), click OK and then click the Reboot Now button. The A.I.M. unit will reboot using the new firmware partition.

Dashboard > Active Connections

Shows only connections that are currently active within the A.I.M. network. Please refer to the Connection Log page section below.

Dashboard > Connection Log

Shows all connections that have occurred within the A.I.M. network. The most recent connections are shown at the top, and the log is paginated (the number of rows per page can be set from the [Dashboard > Settings](#) page). The log can be filtered to show all connections, or only currently active connections. Current connections have no “end time” and a disconnect icon ().

The “Audio Broadcast IP” and “Video Broadcast IP” columns show whether the audio and video are being sent directly from the transmitter to the receiver or broadcast to a multicast group. Direct links are denoted by the receiver’s IP address only; whereas multicast broadcasts are indicated by the multicast icon () and the common multicast IP address (the address will be in the range specified within the “Multicast IP Address” option of the [Dashboard > Settings](#) page).

Actions that you can take within this page include:

- Hover the mouse over the receiver, user or channel names to show more information about each item.
- Hover the mouse over the five “Info” icons to see descriptions (audio on/off; video on/off; USB on/off; shared/exclusive mode; serial on/off).
- Click  to end a connection between a receiver and a channel.

Dashboard > Event Log

This page lists events that have occurred within the A.I.M. system. A drop-down list box is available at the top of the page that allows you to filter log page entries to show only particular categories, as follows:

- **All:** Lists all events
- **Admin:** Lists automatic events and/or those performed by the admin user (including: backup, scheduled backup, backup restored, updating A.I.M. settings, adding/removing/ updating channels/users/devices, Active Directory Sync, Firmware upgrades, A.I.M. upgrades, etc).
- **Users:** Lists events performed by regular users (including: login, logout, channel connections, disconnects, etc).
- **Login:** Lists login and logout events, whether performed via the admin console or receiver devices.
- **Channel Changes:** Lists only channel changes (connections & disconnects).
- **Device Status:** Lists new devices that are added to the A.I.M. network, get restarted/ rebooted or go online/offline

You can archive Event Log data to a CSV file via the “Archive log data” link, which jumps to the relevant section within the [Dashboard > Backups](#) page.

Dashboard > Remote Support

The remote support feature grants a member of the technical support team remote access to the A.I.M. unit. This page shows the current state of remote support, whether currently enabled or disabled, plus a button to change the remote support state.

Note: Before enabling remote support contact Adder technical support.

THE CHANNELS TAB



The Channels tab provides access to all settings and options related directly to the video, audio and USB streams, collectively known as channels, emanating from any number of transmitters.

Click the CHANNELS tab to view the initial View Channels page.



The various other Channels pages (e.g. Add Channel, View Channel Groups, etc.) are selectable within the blue section located just below the tabs.

Search filters

The key fields (Name, Description and Location) all provide a search filter to locate particular items within long lists. Enter a full or partial search string into the appropriate filter box and then click  to start the search. Optionally use the  buttons to invert the order of the listing.

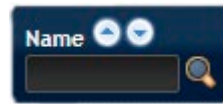





The page will reload with the same pagination/sort order, but with the added search filter. It's possible to filter by several columns at once (e.g. search for all entries with "mac" in the name, and "mixed" in the description). Search terms are case-insensitive. You can re-sort and paginate on filtered results without losing the filters.

To remove a filter, click the red cross next to the relevant filter, (you can also empty the search box and click  again).

Channels > View Channels

This page lists all channels that currently exist within the A.I.M. system. A channel is automatically created for every transmitter when it is added and configured within the A.I.M. network. The new default channel for each added transmitter will inherit the name of the transmitter. Such default names can be altered at any time and additionally, you can also create new channels manually, if necessary.





Within the list of channels, the Allowed Connections column indicates how each channel may be accessed by users. By default, these settings are inherited from the global setting (configurable within the [Dashboard > Settings](#) page), however, each channel can be altered as required. The icons denote the following connection rules:

-  Connection details inherited from the global setting
-  Video-Only
-  Shared
-  Exclusive
-  Private

The Channel Groups column shows how many channel groups each channel belongs to.

The Users column indicates how many users have permission to view each channel.

Actions that you can take within this page include:

- **Create a new channel:** Click the "Add Channel" option.
- **Create a new channel group:** Click the "Add Channel Group" option.
- **Configure an existing channel:** Click  for the required channel.
- **Clone an existing channel:** Click  to use the settings for the current channel as the basis for a new channel entry.
- **Delete a channel:** Click  for the required channel.
- **Delete multiple channels:** Click the "Turn Batch Delete Mode On" button, the  icons for all channels are replaced with tick boxes. Tick the boxes of the channels that need to be deleted and then click the "Delete selected channels" button which appears at the bottom of the page. When you are finished, click the "Turn Batch Delete Mode Off" button.
- **View a channel group:** Click the "View Channel Groups" button.

Channels > Add or Configure a Channel

From the View Channels page, you can add a new channel or configure an existing channel:

- To create a new channel: Click the “Add Channel” option.
- To configure an existing channel: Click  for a channel.

The Add and Configure pages are similar in content.

Channel Name, Description and Location

These are all useful ways for you to identify the channel and its origins. A consistent naming and description policy is particularly useful in large installations.

Video, Audio, USB and Serial

These drop down boxes list all of the available streams from installed transmitters. When creating a channel, you can choose to take all four streams from the same transmitter or from different ones, as required.





Notes: Where necessary, channels can be created without video, audio, USB and/or serial.

Only one receiver can use a transmitter’s serial port at any time.

Allowed Connection

This section allows you to define the types of connection that you wish to permit users to make. You can define particular individual or combined connection types to suit requirements.

Note: This setting for each channel acts as the final arbiter of whether exclusive access can actually be achieved. If you deny exclusive access rights within this setting, then exclusive access for any user cannot take place for this channel, regardless of settings made elsewhere.

- **Inherit from global** - uses the setting of the “Allowed Connection Modes” option within the [Dashboard > Settings](#) page.
-  **Video-Only**: Allows users only to view the video output, the USB channel is denied.
-  **Shared**: Allows users to control a system in conjunction with other users.
-  **Exclusive**: Grants exclusive control to one user while all others can simultaneously view and hear, but not control, the output.
-  **Private**: Allows a user to gain private access to a system, while locking out all others.

Group Membership

Groups provide a quick and easy way to manage settings for channels. By making a channel part of a particular group, the channel automatically inherits the key settings of that group.

The group membership section displays existing channel groups in the left list (to which the current channel does not belong) and the channel groups in the right list to which it does belong.

To add the channel to groups: Highlight one or more (use the CTRL key if selecting more than one) group names in the left list and then click  to add the name(s) to the right list.

Note: You can also include or exclude individual channels by double clicking on them.

To add the channel to all groups: Click  to move all group names from the left to the right list.

To remove the channel from groups: Highlight one or more (use the CTRL key if selecting more than one) group names in the right list and then click  to move the name(s) back to the left list.

To remove the channel from all groups: Click  to move all group names from the right to the left list.

Permissions

This section allows you to determine which users and user groups should be given access to this channel. Individual users and user groups are handled within separate sub-sections, but both use the same method for inclusion and exclusion.

To include one or more users (or groups): Highlight one or more (use the CTRL key if selecting more than one) user/group names in the left list and then click  to add them to the right list.

To include all users (or groups): Click  to move all user/group names from the left to the right list.

To remove one or more users (or groups): Highlight one or more (use the CTRL key if selecting more than one) user/group names in the right list and then click  to move them back to the left list.

To remove all users (or groups): Click  to move all user/group names from the right to the left list.

Channels > Add or Configure Channel Group

Channel groups allow easy permission-granting for several channels at once. Permissions can be set to determine which users can access channels within a channel group.

From the View Channels page, you can add a new channel group or configure an existing channel group:

- To create a new channel: Click the “Add Channel Group” option.
- To configure an existing channel: Click “the View Channel Groups” option and then click  for a group.

The Add and Configure Channel Group pages are similar in content.

Channel Group Name and Description

These are all useful ways for you to identify the channel and its origins. A consistent naming and description policy is particularly useful in large installations.

Group Membership

Allows you to determine which channels should be members of the group. By making a channel part of the group, each channel automatically inherits the key settings of the group.

To add a channel to the group: Highlight one or more (use the CTRL key if selecting more than one) channel names in the left list and then click  to add the name(s) to the right list.

Note: You can also include or exclude individual channels by double clicking on them.

To add all channels to the group: Click  to move all channel names from the left to the right list.

To remove a channel from the group: Highlight one or more (use the CTRL key if selecting more than one) channel names in the right list and then click  to move the name(s) back to the left list.

To remove all channels from the group: Click  to move all channel names from the right to the left list.

Permissions

This section allows you to determine which users and user groups should be given access to channels within this group. Individual users and user groups are handled within separate sub-sections, but both use the same method for inclusion and exclusion.

To include one or more users (or groups): Highlight one or more (use the CTRL key if selecting more than one) user/group names in the left list and then click  to add them to the right list.

To include all users (or groups): Click  to move all user/group names from the left to the right list.

To remove one or more users (or groups): Highlight one or more (use the CTRL key if selecting more than one) user/group names in the right list and then click  to move them back to the left list.

To remove all users (or groups): Click  to move all user/group names from the right to the left list.

THE RECEIVERS TAB

The Receivers tab shows a paginated table of all receiver devices within the A.I.M. network.

Click the RECEIVERS tab to view the initial View Receivers page.

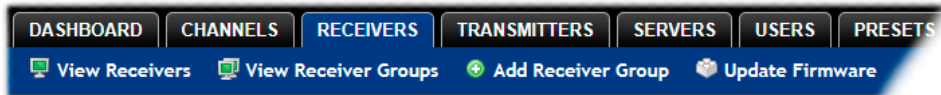

The other Receivers pages (e.g. View Receiver Groups, Add Receiver Group, etc.) are selectable within the blue section located just below the tabs.

Search filters

The key fields (Name, Description and Location) all provide a search filter to locate particular items within long lists. Enter a full or partial search string into the appropriate filter box and then click to start the search. Optionally use the buttons to invert the order of the listing.

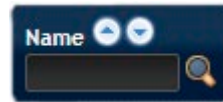

The page will reload with the same pagination/sort order, but with the added search filter. It's possible to filter by several columns at once (e.g. search for all entries with "mac" in the name, and "mixed" in the description). Search terms are case-insensitive. You can re-sort and paginate on filtered results without losing the filters.

To remove a filter, click the red cross next to the relevant filter, (you can also empty the search box and click again).

Receivers > View Receivers

The table shows the following information for each receiver:

- Name
- IP address
- Description & Location
- Online status
- Firmware revision of receiver unit
- Manage (admin options - see below)

The Manage icons are as follows:

(Note: You can hover your mouse pointer over any icons to reveal additional information):

- Configure device:** Displays the "[Configure Receiver](#)" page.
- Reboot device:** Allows you to reboot or reset a unit to its factory settings. A popup will ask which task you wish to carry out. A reboot is useful if a device enters an unknown state. A reset will return the unit to its factory default state and reset its IP address (the unit will retain any firmware updates that have been applied).
- Identify unit:** Causes the LED lights to flash on the front of the selected unit. An alert will be shown if the unit cannot be contacted (e.g. if it is offline).
- Delete device:** Confirmation will be requested. You will need to factory-reset any devices that you wish to re-configure to work with A.I.M..
- Connect to a channel:** A list of available channels is shown, along with connection modes (Video-Only/Shared/Exclusive/Private). The admin user can thus remotely change channel on any receiver.
- Disconnect:** If a receiver is currently connected to a channel, clicking the disconnect icon will end the connection, regardless of who is connected. Hovering over the icon will show which user is connected, which channel they are connected to, and when the connection was created.

Receivers > Configure Receiver

From the View Receivers page, you can configure details for a receiver:

- Click  for a receiver.

Note: If the IP address of the receiver is changed, the device will need to reboot itself.

Device ID / Type - Identity of the receiver.

Online? - Current status.

MAC Address / 2 - Lists the fixed network identifiers for the single or double ports.

Main/Backup Firmware - The current firmware versions contained within the unit.

IP Address 2 - Lists the single or dual IP addresses for the unit. If the DHCP options are ticked then the fields will be grayed out.

Device Name, Description and Location

These are all useful ways for you to identify the receiver and its origins. A consistent naming and description policy is particularly useful in large installations.

Login Required

- **No:** When selected, anyone can use a receiver terminal and connect to a channel. The channels/permissions displayed to this anonymous user are those that are set for the “anonymous user” that is defined within the [Dashboard > Settings](#) page.
- **Inherit from Receiver Groups:** When selected, the requirement for user login will be determined by the “Login Required” settings within the Receiver Groups to which this unit belongs:
 - If ANY of the receiver groups (to which this receiver belongs) are set as “Login Required = Yes”, this receiver will require login.
 - If ANY of the receiver groups (to which this receiver belongs) are set as “Login Required = Inherit...” and the global setting is “login required = yes”, then this receiver will require login.
 - If ALL receiver groups (to which this receiver belongs) are set as “Login Required = No”, then this receiver will NOT require login.
- **Yes:** When selected, a user will need to login with the username and password defined in the “Users” section. They will only be allowed to login if they have been granted permission to access that particular receiver.

Receiver OSD Alerts

Determine the required setting for pop up OSD alerts: Inherit, No or Yes.

Keyboard Country

Select the country code of the keyboard connected to the receiver.

Audio Input Type

Select the required audio input type.

USB settings - see *next page for details*.

Video Compatibility Check

This reads the EDID from the attached monitor and determines whether the monitor is capable of displaying the selected video mode before connecting a channel. This prevents the receiver showing a black screen and the user being locked out because a dual link resolution has been selected to display on a single link monitor.

Force 60Hz

If enabled, the receiver frame rate is held at 60Hz regardless of the video input frame rate. The Video Switching options (below) cannot be altered when this option is enabled.

Video switching

Provides two options for video switching:

- *Fast Switching* (default state) - Retains the same frame rate (at either 50Hz or 60Hz) depending upon which video resolution was displayed first.
- *Match Frame Rate* - Follows the source frame rate and will change the frame rate every time this changes even if the video resolution doesn't change. If you have one receiver switching between 1920x1080@60Hz and 1920x1080@50Hz then this setting will change the frame rate from 60Hz to 50 Hz every time that you switch.

Group Membership

To facilitate collective permission-granting for numerous receivers, a receiver can belong to one or more receiver groups. Any permissions applied to the receiver group are inherited by all receivers that are included within the receiver group. For example, multiple receivers can be made available to a user by placing them all in a receiver group and then granting the user permission to use that receiver group.

Permissions

This is hidden by default as, by default, all users have access to all receivers. You can deny access to particular receivers for a user in this section. However, be aware that users who are included within user groups may have access to the same receivers via their groups.

USB Settings

HID only

If enabled, allows only HID (mice and keyboards) devices to be connected to the receivers.

Disable Isochronous Endpoint OSD Alerts

When an isochronous USB device is connected to the receiver there will no longer be a warning message. ALIF units do not support isochronous devices.

Enable Isochronous Endpoint Attach

Some USB devices combine many USB devices behind a USB hub. e.g a keyboard with audio support. By enabling this option, devices will be allowed to connect to ALIF receivers, however, the isochronous part (e.g. the audio component) of the devices will not work.

Advanced Port

This section allows you to determine USB port behaviour for use with certain USB devices.

The default is no reserved ports, Merging enabled and no feature code (or Quirk) set. It is recommended that these are left at the default settings and are only changed under advice from an Adder FAE.

For each of the four USB ports on the receiver, certain rules can be applied depending upon the USB device connected.

If you have reserved USB ports on the transmitter, you can select which USB port to use for a particular device.

You can turn off USB merging for a particular port. This will slow down switching as the USB device will be enumerated every time that you switch.

You can also enter an advanced feature if it is necessary for your USB device. The drop down lists the feature codes for some known USB devices. Otherwise please contact your local FAE for advice.

Receivers > Add Receiver Group or Configure Group

From the View Receiver Groups page, you can create a new group or configure an existing group:

- To create a new group: Click the “Add Receiver Group” option.
- To configure an existing group: Click  for a group.

The Add and Configure pages are similar in content.

Login Required

- **No:** When selected, anyone can use a receiver terminal and connect to a channel. The channels/permissions displayed to this anonymous user are those that are set for the “anonymous user” defined within the [Dashboard > Settings](#) page.
- **Inherit from global setting:** When selected, the requirement for user login will be determined by the “Login Required” setting within the [Dashboard > Settings](#) page.
- **Yes:** When selected, a user will need to login with the username and password defined in the “Users” section. They will only be allowed to login if they have been granted permission to access devices in the receiver group.

Enable Receiver OSD Alerts

Determine the required setting for pop up OSD alerts: Inherit, No or Yes.

The next fields are the USB settings.

Note: USB port reservation and advanced USB features will be added to future releases of the A.I.M. management system.

Enable Video Compatibility Check

This reads the EDID from the attached monitor and determines whether the monitor is capable of displaying the selected video mode before connecting a channel. This prevents the receiver showing a black screen and the user being locked out because a dual link resolution has been selected to display on a single link monitor.

Force 60Hz

If enabled, the receiver frame rate is held at 60Hz regardless of the video input frame rate. The Video Switching options (below) cannot be altered when this option is enabled.

Video switching

Provides two options for video switching:

- *Fast Switching* (default state) - Retains the same frame rate (at either 50Hz or 60Hz) depending upon which video resolution was displayed first.
- *Match Frame Rate* - Follows the source frame rate and will change the frame rate every time this changes even if the video resolution doesn’t change. If you have one receiver switching between 1920x1080@60Hz and 1920x1080@50Hz then this setting will change the frame rate from 60Hz to 50 Hz every time that you switch.

USB Settings - see [USB Settings](#).

Group Membership

This section allows you to easily include or exclude individual receivers for this group. All relevant group permissions will be applied to all receivers that are included within the group. Receivers that are not currently included in this group within the left list and those receivers that are included within the right list.

To add a receiver to this group: Highlight one or more (use the CTRL key if selecting more than one) receiver names in the left list and then click  to add the name(s) to the right list.

To add all receivers to the group: Click  to move all receiver names from the left to the right list.

To remove a receiver from the group: Highlight one or more (use the CTRL key if selecting more than one) receiver names in the right list and then click  to move the name(s) back to the left list.

To remove all receivers from the group: Click  to move all receiver names from the right to the left list.

Permissions

This is hidden by default because all users have access to all receivers. You can deny access to the receiver group, however, be aware that users who are included within user groups may have been given access to the receiver group via their user groups.

Receivers > Update Firmware

Click this option to go straight to the Dashboard > Updates page.

See [Dashboard > Updates](#) for more details.



THE TRANSMITTERS TAB

The Transmitters tab shows a paginated table of all transmitter devices within the A.I.M. network.

Click the TRANSMITTERS tab to view the transmitters page.



Search filters

The key fields (Name, Description and Location) all provide a search filter to locate particular items within long lists. Enter a full or partial search string into the appropriate filter box and then click  to start the search. Optionally use the  buttons to invert the order of the listing.

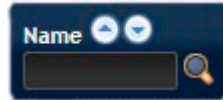

The page will reload with the same pagination/sort order, but with the added search filter. It's possible to filter by several columns at once (e.g. search for all entries with "mac" in the name, and "mixed" in the description). Search terms are case-insensitive. You can re-sort and paginate on filtered results without losing the filters.

To remove a filter, click the red cross next to the relevant filter; (you can also empty the search box and click  again).





Transmitters > View Transmitters

The table shows the following information for each transmitter:

- Type (transmitter type)
- Name
- IP address
- Channels (attributed to each transmitter)
- Description & Location
- Manage (admin options - see below)
- Online status
- Firmware revision of transmitter
- Presets

The Manage icons are as follows:

(Note: You can hover your mouse pointer over any icons to reveal additional information):

-  **Configure device:** Displays the "[Configure Transmitter](#)" page.
-  **Reboot device:** Allows you to reboot or reset a unit to its factory settings. A popup will ask which task you wish to carry out. A reboot is useful if a device enters an unknown state. A reset will return the unit to its factory default state and reset its IP address (the unit will retain any firmware updates that have been applied).
-  **Identify unit:** Causes the LED lights to flash on the front of the selected unit. An alert will be shown if the unit cannot be contacted (e.g. if it is offline).
-  **Delete device:** Confirmation will be requested. You will need to factory-reset any devices that you wish to re-configure to work with A.I.M.

Transmitters > Configure Transmitter

When you click  for a particular transmitter, this page lists information about the unit and allows numerous settings to be configured.

IP Address

Allows you to alter the IP address of the transmitter unit. Any change in address will be enacted when you click the “Save” button at the foot of the page. Any IP connections currently made to the transmitter will be ended.

Device Name, Description and Location

These are useful identifiers for the transmitter unit and its exact location. These become even more valuable as the number of transmitters within the system increases.

Enable Dummy Boot Keyboard

It is often necessary to have a keyboard reported at start up. This setting means that a “Virtual Keyboard” is always reported to the USB host. It may be necessary to disable this for use with some KVM switches.

USB Speed

Select Low/full speed or High speed USB operation.

USB Hub Size

Select either a 13 or 7 port USB hub. This determines the number of USB devices that can be connected to a single Transmitter.

Peak Bandwidth Limiter

The transmitter will use as much of the available network bandwidth as necessary to achieve optimal data quality, although typically the transmitter will use considerably less than the maximum available. In order to prevent the transmitter from ‘hogging’ too much of the network capacity, you can reduce this setting to place a tighter limit on the maximum bandwidth permissible to the transmitter. Range: 1 to 95%.

Video Settings

This section allows you to directly adjust various key video controls within the transmitter in order to obtain the most efficient operation taking into account connection speeds and the nature of the video images sent by that transmitter.

Magic Eye

Determines whether the Magic Eye feature should be enabled on ALIF (1002T, 2002T, 2020T or 2112T models only) transmitters. Magic Eye works to overcome the issues with increased bandwidth usage caused by ‘dithering’ techniques used on some computers, such as Apple Macs. See the ALIF dual user guide for more details.

DDC

Determines whether video configuration details should be harvested from connected display screens or a static fixed EDID report should be used. Care must be taken when selecting a Dual Link Video resolution as only ALIF dual units support a Dual Link Video resolutions. In the case of a Dual Link EDID being set in the Global settings, no EDID will be set on Video port 2 of the ALIF dual transmitters.

EDID optimisation

When this option is ticked, the Transmitters will compare the native resolution settings of their monitors when switching. If the monitor has the same native resolution as the previous one, the new EDID is not sent to the graphics card. This speeds up switching as the graphics card does not have to go through a hotplug detect routine when a new receiver is switched to that channel. If the new receiver has a monitor with a different native resolution, then the EDID will be updated to allow for a change in video mode.

Hot Plug Detect Control

Determines whether to enable hot plug detection for monitors. By default this is enabled.

Hot Plug Detect Signal Period

By default this is set at 100ms, which is sufficient for most graphics cards. Occasionally it may be necessary to adjust this. An Adder engineer will advise if necessary.

Background Refresh

The transmitter sends portions of the video image only when they change. In order to give the best user experience, the transmitter also sends the whole video image, at a lower frame rate, in the background. The Background Refresh parameter controls the rate at which this background image is sent. The default value is ‘every 32 frames’, meaning that a full frame is sent in the background every 32 frames. Reducing this to ‘every 64 frames’ or more will reduce the amount of bandwidth that the transmitter consumes. On a high-traffic network this parameter should be reduced in this way to improve overall system performance. Options: Every 32 frames, Every 64 frames, Every 128 frames, Every 256 frames or Disabled.

Frame Skipping

Frame Skipping involves ‘missing out’ video frames between those captured by the transmitter. For video sources that update only infrequently or for those that update very frequently but where high fidelity is not required, frame skipping is a good strategy for reducing the overall bandwidth consumed by the system. Range: 0 to 99%.

Serial Settings

Serial Parity, Serial Data Bits, Serial Stop Bits, Serial Speed

This group of settings allows you to define the key parameters for the AUX port of the transmitter so that it matches the operation of the device attached to it.

Transmitters > Update Firmware

Click this option to go straight to the Dashboard > Updates page. See [Dashboard > Updates](#) for more details.

Transmitters > Configure New Transmitter

This page is displayed whenever a new transmitter is added to the network.

The IP Address 1 field, showing 0.0.0.0, is for an unconfigured device on its zero config address. Before A.I.M. can add the device into its database, a new IP address must be added to IP Address 1. This is the system IP address and applies equally for ALIF (1000 series) and ALIF dual (2000 series).

ALIF dual units have a Teaming port which provides a second 1 Gigabyte link port which can be used for bandwidth doubling and/or redundancy. The IP address 2 field is for the Teaming port. In order to use the Teaming port, IP address 2 field must be given a valid IP address. For ALIF (1000) units, this field will remain blank.

THE SERVERS TAB

The Servers tab shows a table of all servers within the A.I.M. network.

Click the SERVERS tab to view the page.



For installations that require greater redundancy, it is possible to have two or more AIM servers running on the same subnet. If used on multiple subnets it is possible to have two or more servers on each subnet. If the primary server fails then alternative servers with the same database can take over until the primary unit recovers.

Each server entry will have one of four possible states within the *Rôle* column:

- **Unconfigured** The server is a factory fresh device or has performed a full factory reset. This does not yet have a proper role.
- **Solo** This is a server acting as a standalone A.I.M. server. If there is only going to be one A.I.M. server on the subnet, this is the *Rôle* that should be used.
- **Primary** The server is configured as a fully functional A.I.M. from which a back-up server can be slaved.
- **BackUp** This server is configured to serve as a back up to the Primary.

Each server entry will also show one of six entries within the *Status* column:

- **Active** This server is functioning as an A.I.M. server and is administering ALIF devices. Primary or Solo servers with this status are fully functional A.I.M. servers that will accept network configuration changes. A backup server with this status is functioning as an Active Primary. It will execute channel changes, but will not accept network configuration changes.
- **Standby** This server is currently maintaining its database as a copy of the primary in readiness to take over if necessary.
- **Offline** This server should be maintaining a copy of the primary's database, but is not doing so.
- **Initialising** This is the initial status upon start up. This should not persist beyond the initial start up procedure.
- **Quiescent** This is an inactive server on the network. It will not function without remedial action from its system administration. A typical reason for this is the presence of another server on the network blocking its configured role. i.e. two servers are configured as a primary on the same subnet.
- **Failed** This server has suffered a serious internal failure.

Servers > Configure Server

When you click  for a particular server, this page lists information about the unit and allows several basic settings to be configured.

Rôle

Allows you to change the server's function between primary and solo (see descriptions left).

Device Name, Description and Location

These are useful identifiers for the server unit and its exact location. These become even more valuable as the number of servers within the system increases.

For details about setting up server redundancy, please see [Appendix C - Redundant servers: Setting up and swapping out.](#)

THE USERS TAB

The Users tab shows a paginated table of all users within the A.I.M. network. Within the list, the admin user is always present and cannot be deleted - in order to avoid being locked out of the A.I.M. system. The username and name details of the admin account, however, can be edited as required.

Click the USERS tab to view the initial View Users page.

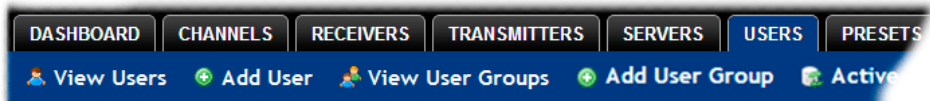

The other user pages (e.g. Add User, View User Groups, etc.) are selectable within the blue section located just below the tabs.

Search filters

The key fields (Username, First Name and Last Name) all provide a search filter to locate particular items within long lists. Enter a full or partial search string into the appropriate filter box and then click to start the search. Optionally use the buttons to invert the order of the listing.

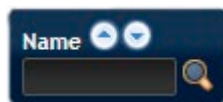

The page will reload with the same pagination/sort order, but with the added search filter. It's possible to filter by several columns at once (e.g. search for all entries with "B" in the Username, and "Smith" in the Last Name). Search terms are case-insensitive. You can re-sort and paginate on filtered results without losing the filters.

To remove a filter, click the red cross next to the relevant filter, (you can also empty the search box and click again).

Users > View Users page

The table shows the following information for each user:

- AD - indicates whether the user was imported from Active Directory
- Username
 - First Name
 - Last Name
- User Groups - the number of user groups to which the user belongs
- Channels - the number of channels to which the user has access
- Receivers - the number of receivers to which the user has access
- Allow Private? - indicates whether the user is permitted to access channels in private mode (✓ - Yes, ✗ - No, - Inherited setting from user groups)
- Remote OSD? - indicates whether the user is permitted to gain OSD access to remote receivers in order to change channels (✓ - Yes, ✗ - No, - Inherited setting from user groups)
- Suspended - indicates the user account status (✓ - User is suspended, ✗ - User account is active, i.e. not suspended)
- AIM Admin - indicates whether the user has admin privileges

The Edit option icons are as follows:

- Configure user:** Displays the "Configure User" page.
- Clone user:** Create a complete copy of the currently selected user entry.
- Delete user:** Confirmation will be requested.

Users > Add User or Configure User page

From the View Users page, you can add a new user or configure an existing user:

- To add a user: Click the “Add User” option.
- To configure an existing user: Click  for a user.

The Add and Configure pages are similar in content.

Username

The username is mandatory and must be unique within the A.I.M. installation.

Note: If a user is synced with Active Directory, it is not possible to change the Username, First/Last Name, Password, or User Group membership. These items must be edited on the Active Directory server and the changes will filter through to A.I.M. the next time a sync takes place with Active Directory.

First Name, Last Name and Email

The First Name, Last Names and Email address entries are optional but are advisable within an installation of any size or one that will be administered by more than one person.

Require Password

Determines whether the chosen user must enter a password to gain access to channels and/or A.I.M. admin system.

Password

The password is required for logging into a channel and/or for logging into the A.I.M. admin system, if the user is to be granted admin privileges.

AIM Administrator?

When set to Yes, the user is granted privileges to login to the A.I.M. admin system and make changes.

Account Suspended?

Allows the admin user to temporarily prevent the user from logging in without the need to delete the whole account.

Allow Private Mode?

Defines whether the user is able to connect to channels privately (locking out other users during a session). When this is set to “Inherit from User Groups/Global Setting”, if ANY user-group that a user is a member of is granted permission to connect exclusively, then the user will have permission to connect exclusively. *Note: It is an additional requirement that the channel being accessed by the user, must also permit exclusive access.*

Enable Remote OSD?

Supported in firmware v3.0 or greater. This option determines whether the chosen user should be permitted to use the remote OSD functionality which permits access to remote receivers in order to change channels or presets even though a user has not logged into those receivers. Please see [Using the Remote OSD](#) feature for details.

Group Membership

This section defines the user groups to which the user will be a member. Any permissions applied to the user group are inherited by all users in the user group. User groups to which the user is not currently a member are shown in the left list and those to which the user is a member are shown within the right list. See [Including and excluding a user..](#) on the next page for details about including and excluding group membership.

Permissions

This section defines to which channels and/or channel groups the user should have access. *Note: Only the channels for which a user is given permission to access will appear within their channel list.*

See [Including and excluding a user...](#) on the next page for details about including and excluding channels and/or channel groups.

Receiver and Receiver Group Permissions

Receiver and Receiver Group Permissions are hidden by default because all users are initially granted permission to use all receivers. If desired, permission to use a receiver and/or receiver group may be withdrawn from a user by revealing this section.

Users > Add User Group or Configure Group page

From the View User Groups page, you can create a new group or configure an existing group:

- To create a new group: Click the “Add User Group” option.
- To configure an existing group: Click  for a group.

The Add and Configure pages are similar in content.

User Group Name

The User Group name must be unique within the A.I.M. installation.

Allow Private Mode?

Defines whether the users within the group will be able to connect to channels privately (locking out other users during the session). When this is set to “Inherit from global setting”, the setting for the “Grant all users private access” option (within [Dashboard > Settings](#)) will be applied. *Note: The final arbiter of whether any user can gain private access is always whether the channel being accessed is also set to allow private connections.*

Enable Remote OSD?

Determines whether members of the chosen user group should be permitted to gain OSD access to remote receivers in order to change channels.

Group Membership

This section allows you to select which users should be members of the group. Any permissions applied to the user group are inherited by all users in the user group. Users who are not currently members are shown in the left list and those who are members are shown within the right list. See Including and excluding a user... on the right for details about including and excluding group membership.

Permissions

This section defines to which channels and/or channel groups the user within this group should have access. *Note: Only the channels/channel groups for which a user is given permission to access will appear within their channel list.*

See **Including and excluding a user...** right for details about including and excluding channels and/or channel groups.

Receiver and Receiver Group Permissions

Receiver and Receiver Group Permissions are hidden by default because all users/user groups are initially granted permission to use all receivers. If desired, permission to use a receiver and/or receiver group may be withdrawn from members of this user group by revealing this section.

Including and excluding a user within group or channels

The Group Membership and Permissions section use the same method to determine inclusion and exclusion:

To add the user to a group or grant access to a channel: Highlight one or more (use the CTRL key if selecting more than one) of the entries in the left list and then click  to add them to the right list (you can also double-click on an entry to quickly add it).

To add the user to all groups or grant access to all channels: Click  to move all entries from the left to the right list.

To remove the user from a group or channel: Highlight one or more (use the CTRL key if selecting more than one) entries in the right list and then click  to move them back to the left list (you can also double-click on an entry to quickly remove it).

To remove the user from all groups or channels: Click  to move all entries from the right to the left list.

Users > Active Directory

To simplify integration alongside existing systems within organisations, A.I.M. can be synchronized with an LDAP/Active Directory server. This allows a list of users (and user groups), together with usernames and group memberships to be quickly imported and kept up to date.

Initial configuration

The basic Active Directory (AD) server details are defined in the [Dashboard > Settings](#) page. Once configured, the Users > Active Directory page (called “Import Users from Active Directory”) will allow you to scan the AD server for a list of folders and users/groups within those folders.

Choosing users and groups

Once scanned, the “Import Users from Active Directory” page shows all folders that are available on the AD server.

- 1 Use the “Include Users” and “Include Groups” checkbox columns on the right hand side of the folder lists to select which items to import (with optional additional LDAP filters where necessary).
 - If an AD user was not in the A.I.M. user database, they will be imported.
 - If an AD user is already in the A.I.M. user database, they are kept.
 - If an AD user is NOT marked for import/sync from the AD import page, and they already exist in the A.I.M. user database, they will be removed from the A.I.M. user database during the sync operation.
IMPORTANT: It is thus vital to ensure that all users you want in the A.I.M. system are always selected for import/sync, otherwise they will be removed.
- 2 Choose the required “Re-Synchronize” interval. Choices are Never, Hourly, Daily or Weekly.
- 3 You can choose to synchronize immediately or to preview the results of your settings:
 - Click the “Preview” button to view the list of users that will be added/updated/removed on this synchronization. Once previewed, you can either go ahead with the sync or return to the filter page and edit your settings.
 - Click the “Save & Sync” button to synchronize the selected items into the A.I.M. user database.

Active Directory Tips

- A backup schedule is recommended so that any changes on the AD server are carried across to the A.I.M. server regularly. You can choose from hourly/daily or weekly syncs. The settings/filters saved on this screen will be applied to each subsequent sync, ensuring that your list of users is kept accurate.
- To temporarily remove a particular user from A.I.M. access, without having to make complicated LDAP filters, simply edit the A.I.M. user to be suspended (see [Users > Add User or Configure User page](#)). Even though they will continue to be imported/synced from AD, they will be prevented from logging on.
- All LDAP filters should be self-contained, e.g: `!(cn=a*)`
- Be sure to save any changes made to the sync settings before clicking the “sync-now” option. Otherwise, the next scheduled sync operation will overwrite any user changes you made in your “sync-now”.
- User groups are only imported from AD to A.I.M. if they contain users that are set to be imported too (i.e. a group will not be imported, even if it contains users, unless its users match the sync filters).
- Associations between users and user groups can only be made on the AD server - it is not possible to edit user/user-group membership for AD users/groups on the A.I.M. server.
- Users and groups are technically “synchronized” rather than “imported” - each time a sync takes place, details are updated and if a user no longer matches the sync filters, they will be removed from the A.I.M. user list.

THE PRESETS TAB

Presets enable multiple actions to be pre-defined so that they can be initiated with a single action. This feature is particularly useful when switching multiple AdderLink Infinity units, such as in the example below where multiple video heads need to be switched in unison between different server systems.

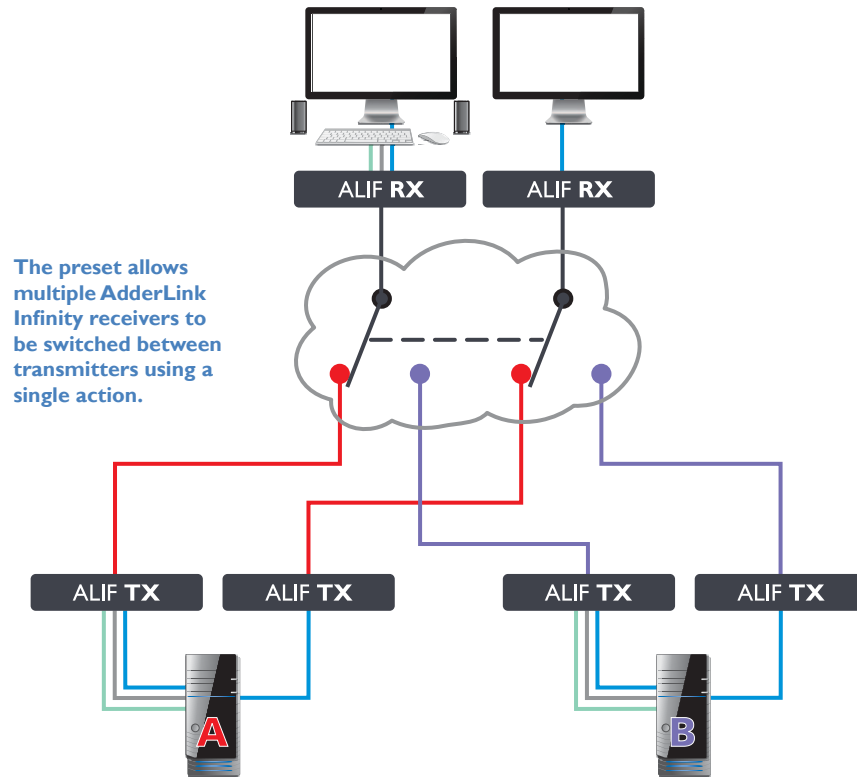

The preset allows multiple AdderLink Infinity receivers to be switched between transmitters using a single action.

According to how a preset is configured, it is possible to have one or more receivers connected to separate channels (i.e. unicast) or multiple receivers connected to a single channel (i.e. multicast).

The Presets page is where the admin user can create and configure new and existing presets.

Click the PRESETS tab to view the Presets page.



The nature of each preset, i.e. which receiver connects to which channel(s), is defined by the admin. The permitted connection modes are worked out according to:

- The topology of the preset, AND
- The current connections within the A.I.M. network.

For instance, if two receivers in a preset are configured to connect to the same channel (multicast), it will not be possible to connect to the preset in exclusive mode.

The presets table shows the preset name, description, allowed connection modes, and number of receiver-channel pairs in the preset.

If any preset-pairs are misconfigured (e.g. a channel no longer exists), a warning triangle will appear. The preset will NOT be usable if any receiver-channel pairs are misconfigured.

The admin user can connect any presets using the standard Video-Only/Shared/Exclusive/Private buttons.

Note: There are no permissions to set for a preset. Instead, a preset will only be available to users who have permission to use ALL receivers and channels within the preset. In other words, permissions on the preset are implied by the permissions on the preset's contents.

continued

Presets > Add or Configure Presets page

From the Presets page, you can add a new preset or configure an existing preset:

- To create a new preset: Click the “Add Preset” option.
- To configure an existing preset: Click  for a preset.

The Add and Configure pages are similar in content.

Preset Name and Description

The Preset Name is mandatory, whereas the Description is optional but recommended when numerous presets will be used. A consistent naming and description policy is particularly useful in large installations.

Receiver - Channel Pairs

Pair 1

From the two drop down lists, choose a receiver and a corresponding channel for it to connect with. This base pair can be altered but cannot be deleted from the preset.





Add another pair

Click this link to define another receiver/channel pairing.

Note: While channels can be assigned to multiple receivers, each receiver may only appear once within a single preset.

Allowed Connections

Choose one of the following connection rules to be applied to the preset:

- Inherit from global setting
-  Video-Only
-  Shared
-  Exclusive
-  Private

Note: If multicasting is present (e.g. two or more receivers connected to the same channel or two channels containing the same audio/video end point), it will not be possible to choose the ‘Private’ connection mode.



THE STATISTICS TAB

The Statistics tab provides an opportunity to view a range of real-time data measurements related to any links within the A.I.M. network. This is particularly useful for optimization and troubleshooting purposes.

Click the STATISTICS tab to view the page.



To view statistics

- 1 To the right of the unit for which you wish to view statistics, click the dark graph icon  so that it gains a white background .
- 2 Click on the device name to display the available statistics.
A dynamic graph will be displayed showing the chosen data series for the selected ALIF units.

For non-admin users, the On-Screen Display provides a clear way to choose and access multiple channels.

LOGGING IN

1 On the keyboard connected to your AdderLink Infinity receiver, press the hotkey combination **Ctrl-Alt-C** to display the On-Screen Display or OSD (this hotkey combination can be altered on the Dashboard > Settings > Receivers page).

You will either see the list of channels for which you have permission or be presented with the following login:



2 Enter your Username and Password and click the Login button to display the [Local OSD screen](#).

Once logged in, you will remain logged in until either you click the Logout link in the top right of the OSD; or there is no activity for two days or until the AdderLink Infinity unit is rebooted.

Hotkey shortcuts



The following standard shortcuts are available for use with the Local OSD (and [Remote OSD](#)). These default shortcuts can be altered within the Dashboard > Settings > Receivers page.

- Left Ctrl + Left Alt + **C**: Launch the OSD
- Left Ctrl + Left Alt + **X**: Disconnect the current receiver
- Left Ctrl + Left Alt + **3**: Connect to the channel/preset saved in shortcut slot 3
- Left Ctrl + Left Alt + **A**: Re-connect to the last channel
- Left Ctrl + Left Alt + **V**: Change the current connection to the video-only mode
- Left Ctrl + Left Alt + **S**: Change the current connection to the shared mode
- Left Ctrl + Left Alt + **E**: Change the current connection to the exclusive mode
- Left Ctrl + Left Alt + **P**: Change the current connection to the private mode

Creating/using favorites and shortcuts



When the OSD contains many possible channels and presets, it can be useful to mark the most commonly visited ones as favorites. For those channels that you'd like to access by keyboard shortcut, there are also ten assignable hotkeys.

To create a new favorite

- 1 Click the  icon next to the required channel or preset.
- 2 Click the **SAVE**  button at the top of the page.

To display favorites

The star shown at the top of the channel list has three appearances to represent the three display modes. Click the star to change the mode:

-  Currently showing all channels/presets.
-  Currently showing only favorites.
-  Currently showing only numbered shortcuts.

To create a new hotkey shortcut

- 1 Click the  icon next to the required channel or preset. The screen will list the ten hotkey slots, with any available slots listed as EMPTY. Click the number prefix (from **1** to **0**) of an available slot.

Note: To remove a previous channel from a slot, click the  icon on the right side of the slot.

- 2 You will now be asked to choose which mode should be used to access the channel when using this shortcut. Select *Video-Only*, *Shared*, *Exclusive* or *Private*, as appropriate.
- 3 Click the **SAVE**  button at the top of the page. As mentioned above, you will now be able to access the chosen channel by using the hotkeys (Left Ctrl + Left Alt, as standard) plus the number that you assigned to it.

THE LOCAL OSD SCREEN

Once [logged in](#), the list of channels for which you have permission are shown in the Local OSD (blue) screen.

- To choose a channel/preset, click on one of the blue connection icons () shown to the right of the required channel/preset name (see the *Connection buttons* box below right).
- Where many channels/presets are listed, use the Channel Name and Description search boxes and list arrows to filter the choices.
- To use the [Remote OSD](#) feature, click the icon in the top right corner.

Favorites icons

- Currently showing all channels/presets
- Currently showing only favorites
- Currently showing only numbered shortcuts
- Click to add this channel as a favorite
- This channel is a numbered shortcut

Sorting icons

- Currently showing channels and presets. Click to change
- Currently showing only channels. Click to change
- Currently showing only presets. Click to change
- Filter this column using the specified term
- Remove the search filter
- Click to sort the list in ascending order via this column
- The list is sorted in ascending order via this column

Click to Logout

CHANNEL NAME	DESCRIPTION	Connection Icons
Channel TX1002	desc TX1002	
Channel TX2000	desc TX2000	
Channel TX2002	desc TX2002	
Channel TX2020	desc TX2020	
Channel TX2112T	desc TX2112T	
preset 0	desc 0	
preset 1	desc 1	
preset 2	desc 2	
preset 3	desc 3	

Displaying channels 1-9 of 9

Top corner icons

- Enter '[Remote OSD](#)' mode
- Exit 'Remote OSD' mode
- Display the help pages
- Refresh the current page
- Close the OSD

Connection buttons

There are four connection modes:

- Video-Only:** Allows users only to view the video output, the USB channel is denied.
- Shared:** Allows users to control a system in conjunction with other users.
- Exclusive:** Grants exclusive control to one user while all others can simultaneously view and hear, but not control, the output.
- Private:** Allows a user to gain private access to a system, while locking out all others.

Connection buttons shown in **blue** are ready to select. Icons in **green** have been selected by another user and those shown in **gray** are not available.

- End this connection

Using the Remote OSD feature

The Remote OSD feature allows authorized users to access and take control of AdderLink Infinity receivers other than the one to which they are connected. Once linked in, users can then determine which channels the remote receivers should link with.

Remote OSD requires the following:

- The A.I.M. server(s) and all ALIF units must have firmware version 3.0 or greater.
- A user must have been given specific authorization to access one or more remote receivers.

To access the Remote OSD

- 1 On the keyboard connected to your AdderLink Infinity receiver, press the hotkey combination **Ctrl-Alt-C** to display the [Local OSD](#) login screen.
- 2 If required, enter your Username and Password and click the Login button.
- 3 In the top right corner, click the icon.



- 4 The screen will list all of the receivers to which you have access rights. Click on the required receiver from the list:



- 5 The Remote OSD for the chosen ALIF receiver will be displayed. Remote OSDs always have a yellow background to differentiate them from the standard local OSD:

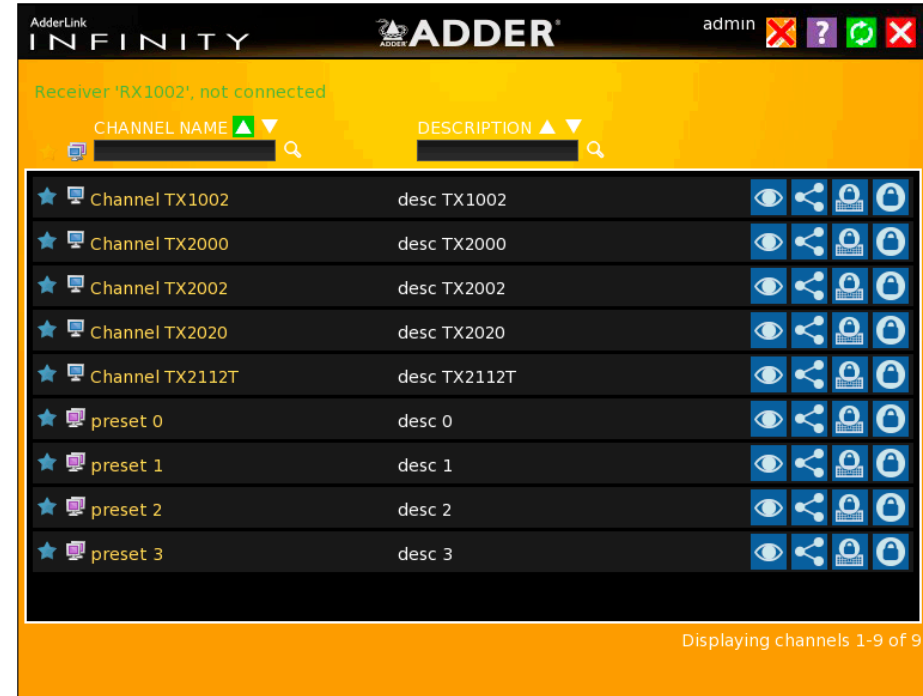

- 6 The behavior of the controls is generally the same as for the [Local OSD](#) screen with the following exceptions:
 - To avoid confusion, you cannot login or logout while in Remote OSD mode. Click the icon to first return to the [Local OSD](#).
 - Hotkeys will only affect the current receiver to which you are connected, not the remotely-controlled receiver.
- 7 To exit from the Remote OSD, click the icon in the top right corner.

This chapter contains a variety of information, including the following:

- Getting assistance - see right
- [Appendix A](#) - Tips for success when networking ALIF and A.I.M. units
- [Appendix B](#) - Troubleshooting
- [Appendix C](#) - Redundant servers: Setting up and swapping out
- [Appendix D](#) - Upgrade license
- [Appendix E](#) - Glossary
- [Appendix F](#) - A.I.M.API
- [Appendix G](#) - DHCP server requirements for ALIF support
- [Appendix H](#) - Technical specifications
- [Safety information](#)
- [Warranty](#)
- [Radio frequency energy statements](#)

GETTING ASSISTANCE

If you are still experiencing problems after checking the information contained within this guide, then we provide a number of other solutions:

- **Online solutions and updates** – www.adder.com/support
Check the Support section of the adder.com website for the latest solutions and firmware updates.
- **Technical support** – www.adder.com/contact-support-form
For technical support, use the contact form in the Support section of the adder.com website - your regional office will then get in contact with you.

APPENDIX A - Tips for success when networking ALIF units

ALIF units use multiple strategies to minimize the amount of data that they send across networks. However, data overheads can be quite high, particularly when very high resolution video is being transferred, so it is important to take steps to maximize network efficiency and help minimize data output. The tips given in this section have been proven to produce very beneficial results.

Summary of steps

- Choose the right kind of switch.
- Create an efficient network layout.
- Configure the switches and devices correctly.

Choosing the right switch

[Layer 2](#) switches are what bind all of the hosts together in the subnet. However, they are all not created equally, so choose carefully. In particular look for the following:

- Gigabit (1000Mbps) or faster Ethernet ports,
- Support for [IGMP v2](#) (or v3) snooping,
- Support for [Jumbo frames](#) up to 9216-byte size,
- High bandwidth connections between switches, preferably Fibre Channel.
- Look for switches that perform their most onerous tasks (e.g. [IGMP snooping](#)) using multiple dedicated processors (ASICS).
- Ensure the maximum number of concurrent 'snoopable groups' the switch can handle meets or exceeds the number of ALIF transmitters that will be used to create multicast groups.
- Check the throughput of the switch: Full duplex, 1Gbps up- and down- stream speeds per port.
- Use the same switch make and model throughout a single subnet.
- You also need a [Layer 3](#) switch. Ensure that it can operate efficiently as an [IGMP Querier](#).

Layer 2 (and 3) switches known to work

- | | | |
|--------------|-------------------------|---|
| • Cisco 2960 | • Extreme Networks X480 | • HuaWei Quidway s5328c-EI (Layer 3 switch) |
| • Cisco 3750 | • HP Procurve 2810 | |
| • Cisco 4500 | • HP Procurve 2910 | |
| • Cisco 6500 | • H3C 5120 | |

For the latest list of switches known to work with ALIF and setup instructions for them, please go to www.adder.com

Creating an efficient network layout

Network layout is vital. The use of [IGMP snooping](#) also introduces certain constraints, so take heed:

- Keep it flat. Use a basic line-cascade structure rather than a pyramid or tree arrangement (see note below).
- Keep the distances between the switches as short as possible.
- Ensure sufficient bandwidth between switches to eliminate bottlenecks.
- Where the A.I.M. server is used to administer multiple ALIF transceivers, ensure the A.I.M. server and all ALIF units reside in the same subnet.
- Do not use VGA to DVI converters, instead replace VGA video cards in older systems with suitable DVI replacements. Converters cause ALIF TX units to massively increase data output.
- Stackable switches will allow you to create more ports at each cascade level.
- Wherever possible, create a private network.

The recommended layout

The layout shown below has been found to provide the most efficient network layout for rapid throughput when using IGMP snooping:

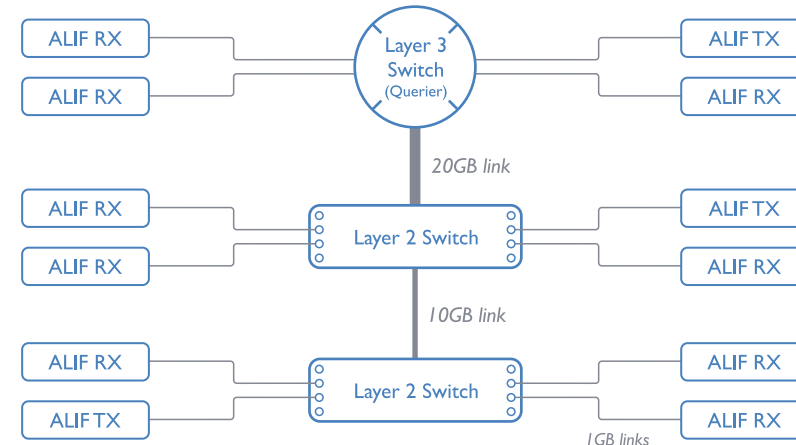

Note: From firmware version 3.0, tree and hierarchical structures of network switches are also supported. The Transmitter now joins its own multicast group so there is always a route from the querier to the transmitter which was previously missing in firmware versions 2.9 and below.

- Use no more than two cascade levels.
- Ensure high bandwidth between the two L2 switches and very high bandwidth between the top L2 and the L3. Typically 10GB and 20GB, respectively for 48 port L2 switches.

Configuring the switches and devices

The layout is vital but so too is the configuration:

- Enable [IGMP Snooping](#) on all L2 switches.
- Ensure that [IGMP Fast-Leave](#) is enabled on all switches with ALIF units connected directly to them.
- Enable the L3 switch as an [IGMP Querier](#).
- Enable [Spanning Tree Protocol \(STP\)](#) on all switches and importantly also enable [portfast](#) (only) on all switch ports that have ALIF units connected.
- If any hosts will use any video resolutions using 2048 horizontal pixels (e.g. 2048 x 1152), ensure that [Jumbo Frames](#) are enabled on all switches.
- Choose an appropriate forwarding mode on all switches. Use [Cut-through](#) if available, otherwise [Store and forward](#).
- Optimize the settings on the ALIF transmitters:
 - If moving video images are being shown frequently, then leave Frame Skipping at a low percentage and instead reduce the Peak bandwidth limiter and Colour Depth.
 - Where screens are quite static, try increasing the Background Refresh interval and/or increasing the Frame skipping percentage setting.

Make changes to the ALIF transmitters one at a time, in small steps, and view typical video images so that you can attribute positive or negative results to the appropriate control.

- Ensure that all ALIF units are fully updated to the latest firmware version (at least v3.3).

APPENDIX B - Troubleshooting

Problem:The video image of the ALIF receiver shows horizontal lines across the screen.

This issue is known as *Blinding* because the resulting video image looks as though you're viewing it through a venetian blind.

When video is transmitted by ALIF units, the various lines of each screen are divided up and transmitted as separate data packets. If the reception of those packets is disturbed, then blinding is caused. The lines are displayed in place of the missing video data packets.

There are several possible causes for the loss of data packets:

- Incorrect switch configuration. The problem could be caused by multicast flooding, which causes unnecessary network traffic. This is what IGMP snooping is designed to combat, however, there can be numerous causes of the flooding.
- Speed/memory bandwidth issues within one or more switches. The speed and capabilities of different switch models varies greatly. If a switch cannot maintain pace with the quantity of data being sent through it, then it will inevitably start dropping packets.
- One or more ALIF units may be outputting Jumbo frames due to the video resolution (2048 horizontal pixels) being used. If jumbo frames are output by an ALIF unit, but the network switches have not been configured to use jumbo frames, the switches will attempt to break the large packets down into standard packets. This process introduces a certain latency and could be a cause for dropped packets.
- One or more ALIF units may be using an old firmware version. Firmware versions prior to v2.1 exhibited an issue with the timing of IGMP join and leave commands that caused multicast flooding in certain configurations.

Remedies:

- Ensure that [IGMP snooping](#) is enabled on all switches within the subnet.
- Where each ALIF unit is connected as the sole device on a port connection to a switch, enable [IGMP Fast-Leave \(aka Immediate Leave\)](#) to reduce unnecessary processing on each switch.
- Check the video resolution(s) being fed into the ALIF transmitters. If resolutions using 2048 horizontal pixels are unavoidable then ensure that [Jumbo frames](#) are enabled on all switches.
- Check the [forwarding mode](#) on the switches. If *Store and forward* is being used, try selecting *Cut-through* as this mode causes reduced latency on lesser switch designs.
- Ensure that one device within the subnet is correctly configured as an [IGMP Querier](#), usually a multicast router.
- Ensure that the firmware in every ALIF unit is version 2.1 or greater.
- Try adjusting the transmitter settings on each ALIF to make the output data stream as efficient as possible. See [Alter ALIF transmitter video settings if necessary](#) for details.

Problem:The audio output of the ALIF receiver sounds like a scratched record.

This issue is called Audio crackle and is a symptom of the same problem that produces blinding (see left). The issue is related to missing data packets.

Remedies:

As per blinding discussed previously.

continued

Problem:A.I.M. cannot locate working ALIF units.

There are a few possible causes:

- The ALIF units must be reset back to their zero config IP addresses for A.I.M. discovery. If you have a working network of ALIF's without A.I.M. and then add A.I.M. to the network A.I.M. will not discover the ALIFs until they are reset to the zero config IP addresses.
- This could be caused by Layer 2 Cisco switches that have [Spanning Tree Protocol \(STP\)](#) enabled but do not also have *portfast* enabled on the ports to which ALIF units are connected. Without portfast enabled, ALIF units will all be assigned the same zero config IP address at reboot and A.I.M. will only acquire them one at a time on a random basis.

You can easily tell whether portfast is enabled on a switch that is running STP: When you plug the link cable from a working ALIF unit into the switch port, check how long it takes for the port indicator to change from orange to green. If it takes roughly one second, portfast is on; if it takes roughly thirty seconds then portfast is disabled.

Remedies:

- Ensure that the ALIF units and the A.I.M. server are located within the same subnet. A.I.M. cannot cross subnet boundaries.
- Manually reset the ALIF units to their zero config IP addresses. Please refer to the ALIF user guide for details.
- Enable *portfast* on all switch ports that have ALIF units attached to them or try temporarily disabling STP on the switches while A.I.M. is attempting to locate ALIF units.

Problem:The mouse pointer of the ALIF receiver is slow or sluggish when moved across the screen.

This issue is often related to either using dithering on the video output of one or more transmitting computers or using VGA-to-DVI video converters.

Dithering is used to improve the perceived quality and color depth of images by diffusing or altering the color of pixels between video frames. This practice is commonly used on Apple Mac computers using ATI or Nvidia graphics cards. VGA-to-DVI converters unwittingly produce a similar issue by creating high levels of pixel background noise.

ALIF units attempt to considerably reduce network traffic by transmitting only the pixels that change between successive video frames. When dithering is enabled and/or VGA-to-DVI converters are used, this can have the effect of changing almost every pixel between each frame, thus forcing the ALIF transmitter to send the whole of every frame: resulting in greatly increased network traffic and what's perceived as sluggish performance.

Remedies:

- **Linux PCs** - Check the video settings on the PC. If the Dither video box option is enabled, disable it.
- **Apple Mac with Nvidia graphics** - Use the Adder utility for Macs (contact technical support).
- **Apple Mac with ATI graphics** - Use the ALIF 2000 series unit with Magic Eye dither removal feature.
- **Windows PCs** - If you suspect these issues with PCs, contact technical support for assistance.

APPENDIX C - Redundant servers: Setting up and swapping out

This appendix contains two main sections related to the creation and repair of A.I.M. server installations that employ redundancy.



- Setting up A.I.M. server redundancy - below
- Swapping out an A.I.M. server - on [next page](#)

Setting up A.I.M. server redundancy

This section details the steps required to successfully configure two A.I.M. units as primary and backup servers.

- 1 Set the Rôle entry to **Primary** on the primary server.
- 2 Configure its Ethernet port 1 Address.
- 3 Ensure that password requirements is set to **NO**.
- 4 Add the new secondary A.I.M. server to the network. The secondary server must have the same license as the primary. It is not possible to have two servers with different licenses in a cluster. This unit must have its factory default settings in place. The new server will appear within the main Servers tab and be identified as being Unconfigured.
- 5 Wait five minutes for automatic server replication to take place and the backup database to be transferred from the primary unit. After this period, the new secondary server will be added to the list on the main Servers tab. Its Rôle will be shown as backup and its Status as standby.

Note: If the transfer of the backup database is interrupted and only a partial database is transferred, then the problem will be reported within the management server page. If this occurs, it will not be possible to log in to the backup database and the firmware version of the backup will be reported as V. After five minutes, you should be given the options of Reboot and Factory Reset. Choose the Factory Reset option in order to clear this issue.

- 6 You can now configure the secondary server in either of two ways:
 - Click the  icon to configure the server remotely from the primary server.
 - Click the  icon to open a restricted page in order to configure the server directly from its own IP address. If you use this option, the configuration options are limited to: view the logs; update/reset AIM and configure this server.

Operation of Redundancy

If the Primary server fails for any reason (for example, loss of power or a network issue) then the secondary server will failover. This will happen automatically without any user intervention, however it is not instantaneous. The failover time required is the value entered in the primary timeout plus 30 seconds for the process to happen. The AdderLink Infinity extenders will start communication with the second IP address that is stored in their configuration and the redundant server will take control of the AdderLink Infinities. When the redundant server is acting as the primary it is not possible to add any new devices or change the configuration. If this is required then the backup server can be promoted to be the primary.

When the primary server comes back online then it will resume its role as the primary. If however the backup server has been promoted to primary, when the primary server comes back its role will need to be factory reset back to the backup. After doing this the AdderLink Infinity endpoints will need to be rebooted. It is not possible to have two primary servers on the same network.

Both the primary and the backup server periodically synchronize their databases to ensure that they are identical. If for any reason the backup server is powered down then any changes to the system configuration will not be maintained by the backup server.

Swapping out an A.I.M. server

Once ALIF devices have been configured to run with an A.I.M. server, their default IP addresses are automatically changed as part of the installation process. In this state the ALIF devices become undetectable to any new A.I.M. server that does not have access to the database of devices. Therefore, if an existing A.I.M. server needs to be replaced within an installation, follow one of the basic procedures given here to smooth the transition.

For solo A.I.M. servers

- 1 Before connecting the new A.I.M. server to the main network, connect the new A.I.M. server to a network switch that is isolated from the main network.
- 2 Use a computer connected to the same switch to [login](#) to the new A.I.M. server management suite.
- 3 Set the Rôle entry to Solo.
- 4 [Set the IP address](#) of the new A.I.M. server to match that of the original unit.
- 5 [Restore a backup file](#) of the original A.I.M. server database to the new device.
- 6 Remove the original A.I.M. server from the network. Connect the new A.I.M. server in its place and power up.
- 7 All the devices will appear as offline. Using a paperclip, perform a factory reset on all the ALIF endpoints so as they acquire the new certificate and keys. All ALIF units require a minimum of firmware version 3.3.

For dual A.I.M. installations using redundancy

The correct procedure depends on which A.I.M. server has failed:

Primary server failure

- 1 Promote the backup server to be the primary server.
- 2 Delete the failed server from the database.
- 3 Replace the faulty primary A.I.M. server with a replacement unit that has the same license version and has its default factory settings in place.
- 4 The replacement server will begin communicating with the primary server and download the database so that it can operate as the backup server. This process may take ten minutes.
- 5 Reboot the Adderlink Infinity endpoints at the earliest opportunity.

Backup server failure

- 1 Delete the failed server from the database.
- 2 Replace the failed backup server with a new unit that has the same license version and has its default factory settings in place.
- 3 The replacement server will begin communicating with the primary server and download the database so that it can operate as the backup server. This process may take ten minutes.
- 4 Reboot the Adderlink Infinity endpoints at the earliest opportunity.

Warning: If step 4, rebooting the Adderlink Infinity endpoints, does not happen then the Adderlink Infinity endpoints will be offline if a failover occurs and will need to be factory reset with a paperclip.

Starting from scratch

If none of the above procedures are used, then the following will be necessary. This will require a certain amount of effort because each ALIF unit must be visited and reset, plus the A.I.M. database will need to be fully reconfigured.

- 1 Place a new A.I.M. server into the network and then perform a factory reset on every ALIF device. This will force the ALIF units back to their default states whereupon they will announce themselves to the new A.I.M. server.
- 2 Use a computer connected to the same network to [login](#) to the new A.I.M. server management suite and begin to recreate the database of devices and users.

APPENDIX D - Upgrade license

A.I.M. servers are licensed according to the number of devices that can be managed. As your installation grows you can purchase an updated A.I.M. license at any time using the procedure outlined below. A range of licenses are available for primary only and primary/failover bundles:

- AIMLIC-48 License for 48 endpoints
- AIMLIC-48-BCK Licenses for Primary and Failover units 48 endpoints
- AIMLIC-96 License for 96 endpoints
- AIMLIC-96-BCK Licenses for Primary and Failover units 96 endpoints
- AIMLIC-192 License for 192 endpoints
- AIMLIC-192-BCK Licenses for Primary and Failover units 192 endpoints
- AIMLIC-288 License for 288 endpoints
- AIMLIC-288-BCK Licenses for Primary and Failover units 288 endpoints
- AIMLIC-UNL License for unlimited endpoints
- AIMLIC-UNL-BCK Licenses for Primary and Failover units unlimited endpoints

To upgrade your A.I.M. license

1 Visit the Dashboard > Settings > General page of the A.I.M. unit to be upgraded. At the bottom of the page, click the 'upgrade license' link:

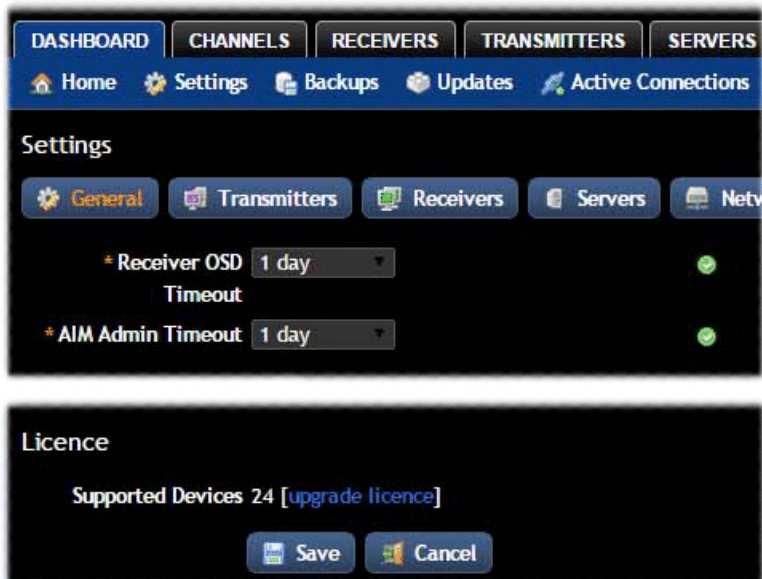

The subsequent file dialog will show a Product Code that is unique to your A.I.M. server:



2 Contact your supplier and quote all of the following:

- The unique product code,
- The serial number of the A.I.M. server (marked on a label on the base of the unit),
- The current number of supported devices, and
- The number of devices to which you wish to upgrade.

3 The supplier will provide a license key, which is unique to unit to the unit to be upgraded. Enter the new license key into the blank entry in the page shown above.

Note: It is important that you only enter the license key into the specific A.I.M. unit.

If the upgrade is successful, the new number of supported devices will be shown in the Dashboard > Settings > General page.

APPENDIX E - Glossary

Internet Group Management Protocol

Where an ALIF transmitter is required to stream video to two or more receivers, multicasting is the method used.

Multicasting involves the delivery of identical data to multiple receivers simultaneously without the need to maintain individual links. When multicast data packets enter a subnet, the natural reaction of the switches that bind all the hosts together within the subnet, is to spread the multicast data to all of their ports. This is referred to as Multicast flooding and means that the hosts (or at least their network interfaces) are required to process plenty of data that they didn't request. IGMP offers a partial solution.

The Internet Group Management Protocol (IGMP) is designed to prevent multicast flooding by allowing [Layer 3](#) switches to check whether host computers within their care are interested in receiving particular multicast transmissions. They can then direct multicast data only to those points that require it and can shut off a multicast stream if the subnet has no recipients.

There are currently three IGMP versions: 1, 2 and 3, with each version building upon the capabilities of the previous one:

- IGMPv1 allows host computers to opt into a multicast transmission using a Join Group message, it is then incumbent on the router to discover when they no longer wish to receive; this is achieved by polling them (see IGMP Querier below) until they no longer respond.
- IGMPv2 includes the means for hosts to opt out as well as in, using a Leave Group message.
- IGMPv3 encompasses the abilities of versions 1 and 2 but also adds the ability for hosts to specify particular sources of multicast data.

AdderLink Infinity units make use of IGMPv2 when performing multicasts to ensure that no unnecessary congestion is caused.

IGMP Snooping

The IGMP messages are effective but only operate at [layer 2](#) - intended for routers to determine whether multicast data should enter a subnet. A relatively recent development has taken place within the switches that glue together all of the hosts within each subnet: IGMP Snooping. IGMP snooping means these layer 2 devices now have the ability to take a peek at the IGMP messages. As a result, the switches can then determine exactly which of their own hosts have requested to receive a multicast – and only pass on multicast data to those hosts.

IGMP Querier

When IGMP is used, each subnet requires one [Layer 3](#) switch to act as a Querier. In this lead role, the switch periodically sends out IGMP Query messages and in response all hosts report which multicast streams they wish to receive. The Querier device and all snooping Layer 2 switches, then update their lists accordingly (the lists are also updated when Join Group and Leave Group (IGMPv2) messages are received).

IGMP Fast-Leave (aka Immediate Leave)

When a device/host no longer wishes to receive a multicast transmission, it can issue an IGMP Leave Group message as mentioned above. This causes the switch to issue an IGMP Group-Specific Query message on the port (that the Leave Group was received on) to check no other receivers exist on that connection that wish to remain a part of the multicast. This process has a cost in terms of switch processor activity and time.

Where ALIF units are connected directly to the switch (with no other devices on the same port) then enabling IGMP Fast-Leave mode means that switches can immediately remove receivers without going through a full checking procedure. Where multiple units are regularly joining and leaving multicasts, this can speed up performance considerably.

Jumbo frames (Jumbo packets)

Since its commercial introduction in 1980, the Ethernet standard has been successfully extended and adapted to keep pace with the ever improving capabilities of computer systems. The achievable data rates, for instance, have risen in ten-fold leaps from the original 10Mbit/s to a current maximum of 100Gbit/s.

While data speeds have increased massively, the standard defining the number of bytes (known as the Payload) placed into each data packet has remained resolutely stuck at its original level of 1500 bytes. This standard was set during the original speed era (10Mbits/s) and offered the best compromise at that speed between the time taken to process each packet and the time required to resend faulty packets due to transmission errors.

But now networks are much faster and files/data streams are much larger; so time for a change? Unfortunately, a wholesale change to the packet size is not straightforward as it is a fundamental standard and changing it would mean a loss of backward compatibility with older systems.

Larger payload options have been around for a while, however, they have often been vendor specific and at present they remain outside the official standard. There is, however, increased consensus on an optional 'Jumbo' payload size of 9000 bytes and this is fully supported by the AdderLink Infinity (ALIF) units.

Jumbo frames (or Jumbo packets) offer advantages for ALIF units when transmitting certain high resolution video signals across a network. This is because the increased data in each packet reduces the number of packets that need to be transferred and dealt with - thus reducing latency times.

The main problem is that for jumbo frames to be possible on a network, all of the devices on the network must support them.

Spanning Tree Protocol (STP)

In order to build a robust network, it is necessary to include certain levels of redundancy within the interconnections between switches. This will help to ensure that a failure of one link does not lead to a complete failure of the whole network.

The danger of multiple links is that data packets, especially multicast packets, become involved in continual loops as neighbouring switches use the duplicated links to send and resend them to each other.

To prevent such bridging loops from occurring, the Spanning Tree Protocol (STP), operating at [layer 2](#), is used within each switch. STP encourages all switches to communicate and learn about each other. It prevents bridging loops by blocking newly discovered links until it can discover the nature of the link: is it a new host or a new switch?

The problem with this is that the discovery process can take up to 50 seconds before the block is lifted, causing problematic timeouts.

The answer to this issue is to enable the **portfast** variable for all host links on a switch. This will cause any new connection to go immediately into forwarding mode. However, take particular care not to enable portfast on any switch to switch connections as this will result in bridging loops.

Forwarding modes

In essence, the job of a layer 2 switch is to transfer as fast as possible, data packets arriving at one port out to another port as determined by the destination address. This is known as data forwarding and most switches offer a choice of methods to achieve this. Choosing the most appropriate forwarding method can often have a sizeable impact on the overall speed of switching:

- **Store and forward** is the original method and requires the switch to save each entire data packet to buffer memory, run an error check and then forward if no error is found (or otherwise discard it).
- **Cut-through** was developed to address the latency issues suffered by some store and forward switches. The switch begins interpreting each data packet as it arrives. Once the initial addressing information has been read, the switch immediately begins forwarding the data packet while the remainder is still arriving. Once all of the packet has been received, an error check is performed and, if necessary, the packet is tagged as being in error. This checking 'on-the-fly' means that cut-through switches cannot discard faulty packets themselves. However, on receipt of the marked packet, a host will carry out the discard process.
- **Fragment-free** is a hybrid of the above two methods. It waits until the first 64 bits have been received before beginning to forward each data packet. This way the switch is more likely to locate and discard faulty packets that are fragmented due to collisions with other data packets.
- **Adaptive** switches automatically choose between the above methods. Usually they start out as a cut-through switches and change to store and forward or fragment-free methods if large number of errors or collisions are detected.

So which one to choose? The *Cut-through* method has the least latency so is usually the best to use with AdderLink Infinity units. However, if the network components and/or cabling generate a lot of errors, the *Store and forward* method should probably be used. On higher end store and forward switches, latency is rarely an issue.

Layer 2 and Layer 3: The OSI model

When discussing network switches, the terms Layer 2 and Layer 3 are very often used. These refer to parts of the Open System Interconnection (OSI) model, a standardised way to categorize the necessary functions of any standard network.

There are seven layers in the OSI model and these define the steps needed to get the data created by you (imagine that you are Layer 8) reliably down onto the transmission medium (the cable, optical fibre, radio wave, etc.) that carries the data to another user; to complete the picture, consider the transmission medium is Layer 0. In general, think of the functions carried out by the layers at the top as being complex, becoming less complex as you go lower down.

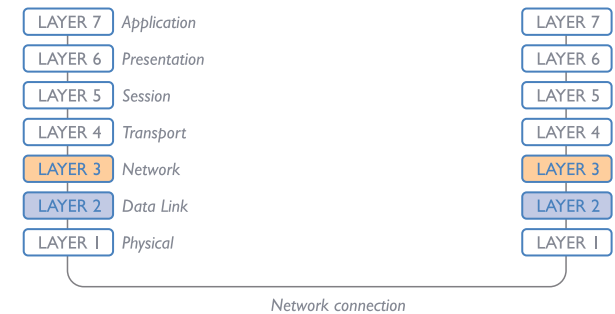

As your data travel down from you towards the transmission medium (the cable), they are successively encapsulated at each layer within a new wrapper (along with a few instructions), ready for transport. Once transmission has been made to the intended destination, the reverse occurs: Each wrapper is stripped away and the instructions examined until finally only the original data are left.

So why are Layer 2 and Layer 3 of particular importance when discussing AdderLink Infinity? Because the successful transmission of data relies upon fast and reliable passage through network switches – and most of these operate at either Layer 2 or Layer 3.

continued

The job of any network switch is to receive each incoming network packet, strip away only the first few wrappers to discover the intended destination then rewrap the packet and send it in the correct direction.

In simplified terms, the wrapper that is added at Layer 2 (by the sending system) includes the physical address of the intended recipient system, i.e. the unique MAC address (for example, 09:f8:33:d7:66:12) that is assigned to every networking device at manufacture. Deciphering recipients at this level is more straightforward than at Layer 3, where the address of the recipient is represented by a logical IP address (e.g. 192.168.0.10) and requires greater knowledge of the surrounding network structure. Due to their more complex circuitry, Layer 3 switches are more expensive than Layer 2 switches of a similar build quality and are used more sparingly within installations.

APPENDIX F - A.I.M. API

The A.I.M. API provides access for external applications to key routines used within the A.I.M. server. This appendix provides a reference to the available methods.

API version: 4

Changelog

- v4 (AIM v4.1) - added create_channel, delete_channel; updated get_channels.
- v3 (AIM v3.2) - added create_preset, delete_preset.
- v2 (AIM v2.3) - added get_devices, get_channels, connect_channel, disconnect_channel. Updated version compatibility information.
- v1 (AIM v1.3) - added login, logout, get_presets, connect_preset, disconnect_preset

Methods

login
logout
get_devices
get_channels
get_presets
connect_channel
connect_preset
disconnect_channel
disconnect_preset
create_preset
delete_preset
create_channel
delete_channel

login

This method was last updated in API version 1, and is compatible with API requests from version 1 onwards

The API will require a valid AIM user's login credentials to be presented in the first request. The API will return an authentication code, which must be passed in all future requests. This authentication code can be re-used until a logout request is made, at which point the authentication code will no longer be valid.

The concept of an 'anonymous user' can apply to the API. If no login username and password are provided, the API will return an authentication token for the anonymous user (either the same one as for the OSD, or else an 'anonymous API user' account can be created).

Input parameters:

- username
- password
- v (the AIM API version this request is designed for)

Output values:

- timestamp - the current server time
- version - the current API version number
- token - an authentication code for future API requests
- success

Examples

Input:

```
/api/?v=1&method=login&username=xxxxx&password=xxxxx
```

Output:

```
<api_response>
  <version>1</version>
  <timestamp>2012-12-14 12:12:12</timestamp>
  <success>1</success>
  <token>5cf494a71c29e9465a57a81e0a2d602c</token>
</api_response>
or
<api_response>
  <version>1</version>
  <timestamp>2012-12-14 12:12:12</timestamp>
  <success>0</success>
  <errors>
    <error>
      <code>2</code>
      <msg>Invalid username or password</msg>
    </error>
  </errors>
</api_response>
```

logout

This method was last updated in API version 1, and is compatible with API requests from version 1 onwards

The authentication token provided by the Login function can be used until the logout function is called.

Input parameters:

- token
- v (the AIM API version this request is designed for)

Output values:

- timestamp - the current server time
- success - 0 = fail, 1 = success

Examples

Input:

```
/api/?method=logout&token=xxxxx&v=1
```

Output:

```
<api_response>  
  <version>1</version>  
  <timestamp>2011-02-04 15:24:15</time>  
  <success>1</success>
```

```
</api_response>
```

or

```
<api_response>  
  <version>1</version>  
  <timestamp>2012-12-12 12:12:12</timestamp>  
  <success>0</success>  
  <errors>  
    <error>  
      <code>3</code>  
      <msg>Error logging out (you may already have logged out)</msg>
```

```
</error>
```

```
</errors>
```

```
</api_response>
```

get_devices

This method was last updated in API version 2, and is compatible with API requests from version 2 onwards

This function returns a list of devices.

Input parameters:

- token
- v (the AIM API version this request is designed for)
- device_type ('rx' = receivers, 'tx' = transmitters. Default = 'rx')
- filter_d_name (Optional. Device name search string)
- filter_d_description (Optional. Device description search string)
- filter_d_location (Optional. Device location search string)
- sort (Optional. Sort results by 'name'/'description'/'location'. Default = 'name')
- sort_dir (Optional. Sort direction for results 'asc'/'desc'. Default = 'asc')
- status (Optional. ',outdated_aim_ip','rebooting','offline','outdated_firmware','invalid_backup_firmware','rebooting','upgrading_firmware','backup_mode')
- show_all (Optional. If set and not blank, shows all receivers, not just those the logged-in user is permitted to use)
- page (page number to start showing results for, default = 1)
- results_per_page (number of results per page, default = 1000)

Output values:

- version - the current API version number
- timestamp - the current server time
- success
- page (page number)
- results_per_page (number of results per page, default = unlimited)
- total_devices - the total number of devices
- count_devices - the number of devices on this page

continued

get_devices (continued)

- for each device:
 - attribute: item (e.g. 17th device)
 - d_id (device ID)
 - d_mac_address (MAC address for interface 1)
 - d_mac_address2 (MAC address for interface 2)
 - d_name (device name)
 - d_online (0 = interface 1 offline, 1 = interface 1 online)
 - d_online2 (0 = interface 2 offline, 1 = interface 2 online)
 - d_type (rx, tx)
 - d_version (1 = ALIF1000R/ALIF1000T, 2 = all other devices)
 - d_variant ('b' = ALIF2002T, 'v' = ALIF2112T, 's' = ALIF1002R/ALIF1002T, 't' = ALIF2020R/ALIF2020T)
 - d_ip_address (IP address for interface 1)
 - d_ip_address2 (IP address for interface 2)
 - d_description (device description)
 - d_location (device location)
 - d_configured (0 = no, 1 = yes)
 - d_valid_firmware (0 = no, 1 = yes)
 - d_valid_backup_firmware (0 = no, 1 = yes)
 - d_firmware (firmware version, e.g. 2.5.17879)
 - d_backup_firmware (backup firmware version)
 - d_date_added (Date device added to AIM network e.g. 2012-07-13 22:17:22)
 - d_status (0 = device offline, 1 = device online, 2 = rebooting, 4 = firmware_upgrading, 6 = running backup firmware)

The following property is only returned for transmitters:

- count_transmitter_channels (the number of channels containing this transmitter)

The following properties are only returned for receivers:

- con_exclusive (0/1 - if the last connection is/was in private mode)
- con_control (1/2/3 - 1 if the last connection is/was video-only, 2 if in exclusive mode, 3 if in shared mode)
- con_start_time (start time of last connection e.g. 2012-09-07 13:33:17)
- con_end_time (empty if connection still active, else date/time the connection was ended e.g. 2012-09-07 13:33:17)
- u_username (username of the user who initiated the last connection)
- u_id (user ID of the user who initiated the last connection)
- c_name (name of the channel last connected)
- count_receiver_groups (the number of receiver groups this receiver is a part of)
- count_receiver_presets (the number of presets this receiver is a part of)
- count_users (the number of users who have access to this receiver)

Examples

Input:

```
/api/?v=2&method=get_devices&token=xxxxx
```

```
/api/?v=2&method=get_devices&device_type=tx&page=2&results_per_page=3&token=xxxxx
```

Output:

```
<api_response>
  <version>2</version>
  <timestamp>2012-09-12 14:56:11</timestamp>
  <success>1</success>
  <page>2</page>
  <results_per_page>3</results_per_page>
  <total_devices>12</total_devices>
  <count_devices>3</count_devices>
  <devices>
    <device item="4">
      <d_id>170</d_id>
      <d_mac_address>00:0F:58:01:6E:3D</d_mac_address>
      <d_mac_address2>00:0F:58:5B:6E:3D</d_mac_address2>
      <d_name>RX 123</d_name>
      <d_online>1</d_online>
      <d_online2>0</d_online2>
      <d_type>rx</d_type>
      <d_version>2</d_version>
      <d_variant></d_variant>
      <d_ip_address>10.10.10.66</d_ip_address>
      <d_ip_address2>10.10.10.67</d_ip_address2>
      <d_description></d_description>
      <d_location>Server Rack 3</d_location>
      <d_configured>1</d_configured>
      <d_valid_firmware>1</d_valid_firmware>
      <d_valid_backup_firmware>1</d_valid_backup_firmware>
      <d_firmware>2.3.16682</d_firmware>
      <d_backup_firmware>2.3.16682</d_backup_firmware>
      <d_date_added>2012-07-14 01:37:07</d_date_added>
```

get_devices (continued)

```

<d_status>1</d_status>
<con_exclusive>0</con_exclusive>
<con_control>1</con_control>
<con_start_time>2012-09-07 13:33:19</con_start_time>
<con_end_time/>
<u_username>admin</u_username>
<u_id>1</u_id>
<c_name>Channel 1</c_name>
<count_receiver_groups>1</count_receiver_groups>
<count_receiver_presets>2</count_receiver_presets>
<count_users>1</count_users>
</device>
</devices>
</api_response>
<api_response>
<version>2</version>
<timestamp>2012-09-12 14:56:11</timestamp>
<success>1</success>
<page>1</page>
<results_per_page>1</results_per_page>
<total_devices>1</total_devices>
<count_devices>1</count_devices>
<devices>
<device item="1">
<d_id>64</d_id>
<d_mac_address>00:0F:58:01:56:85</d_mac_address>
<d_mac_address2>00:0F:58:5B:56:85</d_mac_address2>
<d_name>TX 456</d_name>
<d_online>0</d_online>
<d_online2>0</d_online2>
<d_type>tx</d_type>
<d_version>1</d_version>
<d_variant></d_variant>
<d_ip_address>1.1.201.31</d_ip_address>
<d_ip_address2>1.1.201.32</d_ip_address2>
<d_description></d_description>
<d_location></d_location>

```

```

<d_configured>1</d_configured>
<d_valid_firmware>1</d_valid_firmware>
<d_valid_backup_firmware>1</d_valid_backup_firmware>
<d_firmware>2.1.15747</d_firmware>
<d_backup_firmware>2.1.15747</d_backup_firmware>
<d_date_added>2012-07-13 17:50:04</d_date_added>
<d_status>0</d_status>
<count_transmitter_channels>3</count_transmitter_channels>
</device>
</devices>
</api_response>

```

get_channels

This method was last updated in API version 4, and is compatible with API requests from version 2 onwards.

This function returns a list of channels available to the authenticated user, for a specific receiver. It was updated in version 4 to include additional information.

Input parameters:

- token
- v (the AIM API version this request is designed for)
- page (page number to start showing results for, default = 1)
- results_per_page (number of results per page, default = 1000)
- device_id (ID of the receiver that this channel will be connected to. Recommended to ensure full checks for connection mode availability.
- filter_c_name (channel name search string)
- filter_c_description (channel description search string)
- filter_c_location (channel location search string)
- filter_favourites (set this non-empty to only show a user's favourites)

Output values:

- version - the current API version number
- timestamp - the current server time
- success
- page (page number)
- results_per_page (number of results per page, default = unlimited)
- count_channels - the number of channels on this page, available to the authenticated user

continued

get_channels (continued)

- for each channel:

- attribute: item (e.g. 17th channel)
- c_id (channel id)
 - c_name (channel name)
 - c_description (channel description)
 - c_location (channel location)
 - c_favourite (true if this channel is in the user's favourites, 0-9 if it's a numbered shortcut)
- view_button (disabled/enabled/hidden - whether the user can connect to the preset in video-only mode.
 - disabled = no, because something is in use by someone else.
 - hidden = never. enabled = yes
- If the device_id of the proposed receiver to be used in the connection is not provided, this will not necessarily be an accurate indication of whether other connections may actually interfere)
- shared_button (disabled/enabled/hidden - as above, but in shared mode)
- control_button (disabled/enabled/hidden - as above, but in exclusive mode)
- exclusive_button (disabled/enabled/hidden - as above, but in private mode)

Additional channel output values in version 4:

- c_video1 (device ID)
- c_video1_head (1|2)
- c_video2 (device ID)
- c_video2_head (1|2)
- c_audio (device ID)
- c_usb (device ID)
- c_serial (device ID)

Examples

Input:

/api/?v=2&method=get_channels&token=xxxxx

Version 2 output:

```
<api_response>
  <version>2</version>
  <timestamp>2012-12-14 12:12:12</timestamp>
  <success>1</success>
```

```
<page>1</page>
<results_per_page>10</results_per_page>
<count_channels>2</count_channels>
<channel item="1">
  <c_id>3</c_id>
  <c_name>Channel 1</c_name>
  <c_description>Description for Channel 1</c_description>
  <c_location>Location of Channel 1</c_location>
  <c_favourite>>false</c_favourite>
  <view_button>disabled</view_button>
  <shared_button>disabled</shared_button>
  <control_button>disabled</control_button>
  <exclusive_button>disabled</exclusive_button>
</channel>
<channel item="2">
  <c_id>5</c_id>
  <c_name>Channel 2</c_name>
  <c_description>Description for Channel 2</c_description>
  <c_location>Location of Channel 2</c_location>
  <c_favourite>2</c_favourite>
  <view_button>enabled</view_button>
  <shared_button>enabled</shared_button>
  <control_button>enabled</control_button>
  <exclusive_button>hidden</exclusive_button>
</channel>
</api_response>
```

get_presets

This method was last updated in API version 1, and is compatible with API requests from version 1 onwards.

This simple function returns a list of presets available to the authenticated user.

Input parameters:

- token
- v (the AIM API version this request is designed for)
- results_per_page (number of results per page, default = 1000)
- page (page number to start showing results for, default = 1)

Output values:

- version - the current API version number
- timestamp - the current server time
- success
- page (page number)
- results_per_page (number of results per page, default = unlimited)
- total_presets - the total number of presets available to the authenticated user
- count_presets - the number of presets on this page, available to the authenticated user
- for each connection_preset:
 - attribute: item (e.g. 17th preset)
 - cp_id (preset id)
 - cp_name (preset name)
 - cp_description (preset description)
 - cp_pairs (the number of channel-receiver pairs in this preset)
 - problem_cp_pairs (the number of channel-receiver pairs that are mis-configured (e.g. receiver offline, receiver not defined))
 - cp_active (whether all, any, or none of the channel-receiver pairs in this preset are currently connected; values are 'full', 'partial', and 'none')
 - connected_rx_count (the number of receivers in this preset that are already connected)
 - view_button (disabled/enabled/hidden - whether the user can connect to the preset in video-only mode.
 - disabled = no, because something is in use by someone else.
 - hidden = never. enabled = yes)
 - shared_button (disabled/enabled/hidden - as above, but in shared mode)
 - control_button (disabled/enabled/hidden - as above, but in exclusive mode)
 - exclusive_button (disabled/enabled/hidden - as above, but in private mode)

Examples

Input:

```
/api/?v=1&method=get_presets&token=xxxxx
```

Output:

```
<api_response>
  <version>1</version>
  <timestamp>2012-12-14 12:12:12</timestamp>
  <success>1</success>
  <page>1</page>
  <results_per_page>10</results_per_page>
  <total_presets>2</total_presets>
  <count_presets>2</count_presets>
  <connection_preset item="1">
    <cp_id>3</cp_id>
    <cp_name>Preset 1</cp_name>
    <cp_description>Description for Preset 1</cp_description>
    <cp_pairs>1</cp_pairs>
    <problem_cp_pairs/>
    <cp_active>full</cp_active>
    <connected_rx_count>1</connected_rx_count>
    <view_button>disabled</view_button>
    <shared_button>disabled</shared_button>
    <control_button>disabled</control_button>
    <exclusive_button>disabled</exclusive_button>
  </connection_preset>
  <connection_preset item="2">
    <cp_id>4</cp_id>
    <cp_name>Preset 2</cp_name>
    <cp_description>Description for Preset 2</cp_description>
    <cp_pairs>2</cp_pairs>
    <problem_cp_pairs/>
    <cp_active>none</cp_active>
    <connected_rx_count/>
    <view_button>enabled</view_button>
    <shared_button>hidden</shared_button>
    <control_button>hidden</control_button>
    <exclusive_button>hidden</exclusive_button>
  </connection_preset>
</api_response>
```

connect_channel

This method was last updated in API version 2, and is compatible with API requests from version 2 onwards.

This simple function connects a receiver to a channel.

Input parameters:

- token
- v (the AIM API version this request is designed for)
- c_id - the ID of the channel (acquired from get_channels)
- rx_id - the ID of the receiver (acquired from get_receivers)
- view_only (optional, 0/1 - defaults to 0)
- exclusive (optional, 0/1 - defaults to 0)

Output values:

- version - the current API version number
- timestamp - the current server time
- success (0 = fail, 1 = success)
- errors (optional, if anything went wrong with connecting the channel)

Examples

Input:

```
/api/?v=2&method=connect_channel&token=xxxxx&c_id=1&rx_id=2&exclusive=1
```

Output:

```
<api_response>
  <version>2</version>
  <timestamp>2012-12-12 12:12:12</timestamp>
  <success>1</success>
</api_response>
or
<api_response>
  <version>2</version>
  <timestamp>2012-12-12 12:12:12</timestamp>
  <success>0</success>
  <errors>
    <error>
      <code>231</code>
      <msg>ERROR - private connection not available</msg>
    </error>
  </errors>
</api_response>
```

connect_preset

This method was last updated in API version 1, and is compatible with API requests from version 1 onwards.

This simple function connects all channel-receiver pairs in a preset.

Input parameters:

- token
- v (the AIM API version this request is designed for)
- id - the ID of the preset (acquired from get_presets)
- view_only (optional, 0/1 - defaults to 0)
- exclusive (optional, 0/1 - defaults to 0)
- force (optional, 0/1 - defaults to 0) - whether to ignore errors with some of the preset's pairs or not

Output values:

- version - the current API version number
- timestamp - the current server time
- success (0 = fail, 1 = success)
- errors (optional, if anything went wrong with connecting the presets)

Examples

Input:

```
/api/?v=1&method=connect_preset&token=xxxxx&id=1&force=1
```

Output:

```
<api_response>
  <version>1</version>
  <timestamp>2012-12-12 12:12:12</timestamp>
  <success>1</success>
</api_response>
or
<api_response>
  <version>1</version>
  <timestamp>2012-12-12 12:12:12</timestamp>
  <success>0</success>
  <errors>
    <error>
      <code>210</code>
      <msg>".$config['error_codes'][210]."</msg>
    </error>
  </errors>
</api_response>
```

disconnect_channel

This method was last updated in API version 2, and is compatible with API requests from version 2 onwards.

This function disconnects a receiver, a number of receivers, or all connected receivers.

Input parameters:

- token
- v (the AIM API version this request is designed for)
- rx_id (ID(s) of the receiver, as an integer, or comma-separated set of integers.
Optional. If not supplied, all connections will be ended)
- force - whether to disconnect existing connections by other users, or for offline receivers

Output values:

- version - the current API version number
- timestamp - the current server time
- success (0 = fail, 1 = success)
- errors (if anything failed, details are returned here)

Examples

Input:

/api/?v=2&method=disconnect_channel&token=xxxxx (disconnect all your online, connected channels)

/api/?v=2&method=disconnect_channel&token=xxxxx&rx_id=1 (disconnect channel 1, if you connected it and it's online)

/api/?v=2&method=disconnect_channel&token=xxxxx&rx_id=1,2,3 (disconnect channels 1, 2, and 3, if you connected them and they're online)

/api/?v=2&method=disconnect_channel&token=xxxxx&force=1 (force disconnect all connected channels)

/api/?v=2&method=disconnect_channel&token=xxxxx&rx_id=1,3&force=1 (force disconnect channels 1 and 3)

Output:

```
<api_response>
  <version>2</version>
  <timestamp>2012-12-12 12:12:12</timestamp>
  <success>1</success>
</api_response>
```

disconnect_preset

This method was last updated in API version 1, and is compatible with API requests from version 1 onwards.

This function disconnects all channel-receiver pairs in a preset, or disconnects ALL connections in the whole AIM network.

Input parameters:

- token
- v (the AIM API version this request is designed for)
- id (optional. If not supplied, all connections will be ended)
- force - whether to ignore errors with some of the preset's pairs or not

Output values:

- version - the current API version number
- timestamp - the current server time
- success (0 = fail, 1 = success)
- errors (if anything failed, details are returned here)

Examples

Input:

/api/?v=1&method=disconnect_preset&token=xxxxx&id=1&force=1

Output:

```
<api_response>
  <version>1</version>
  <timestamp>2012-12-12 12:12:12</timestamp>
  <success>1</success>
</api_response>
```

create_preset

This method was last updated in API version 3, and is compatible with API requests from version 3 onwards

This function creates a new preset. The API user must have admin privileges to call this method successfully.

Input parameters:

- token
- v (the AIM API version this request is designed for)
- name (the display name for the new preset)
- pairs (a comma-separated list of the channel ID–receiver ID pairs for the preset, where each ID in the pair is separated by a hyphen)
- allowed (the permitted connection modes for the preset. Optional; if omitted, the global setting will be inherited. Permitted values are:
 - v - video-only
 - vs - video-only and shared
 - s - shared only
 - e - private only
 - vse - any mode allowed)

Output values:

- version - the current API version number
- timestamp - the current server time
- success (0 = fail, 1 = success)
- errors (if anything failed, details are returned here)
- id (the ID of the new preset, if it was created)

Examples

Input:

```
/api/?v=3&method=create_preset&token=xxxxx&name=my_preset&pairs=1-1,1-2,2-3,2-4&allowed=vs
```

Output:

```
<api_response>
  <version>3</version>
  <timestamp>2012-12-12 12:12:12</timestamp>
  <success>1</success>
  <id>5</success>
</api_response>
```

delete_preset

This method was last updated in API version 3, and is compatible with API requests from version 3 onwards

This function deletes a preset. The API user must have admin privileges to call this method successfully.

Input parameters:

- token
- v (the AIM API version this request is designed for)
- id (the ID of the preset to be deleted)

Output values:

- version - the current API version number
- timestamp - the current server time
- success (0 = fail, 1 = success)
- errors (if anything failed, details are returned here)

Examples

Input:

```
/api/?v=3&method=delete_preset&token=xxxxx&id=5
```

Output:

```
<api_response>
  <version>3</version>
  <timestamp>2012-12-12 12:12:12</timestamp>
  <success>1</success>
</api_response>
```

create_channel

This method was last updated in API version 4, and is compatible with API requests from version 4 onwards.

This function creates a new channel. The API user must have admin privileges to call this method successfully.

Note that, although the source device ID inputs are each optional, at least one is required.

Input parameters:

- token
- v (the AIM API version this request is designed for)
- name (the display name for the new channel)
- desc (the display description for the new channel. Optional, default is empty.)
- loc (the display location for the new channel. Optional, default is empty.)
- allowed (the permitted connection modes for the channel. Optional; if omitted, the global setting will be inherited. Permitted values are:
 - v - video-only
 - vs - video-only and shared
 - s - shared only
 - e - private only
 - vse - any mode allowed)
- video1 (device ID of video source 1. Optional, default is empty.)
- video1head (video head number for source 1. Optional, default is 1.)
- video2 (device ID of video source 2. Optional, default is empty.)
- video2head (video head number for source 2. Optional, default is 1.)
- audio (device ID of the audio source. Optional, default is empty.)
- usb (device ID of the usb source. Optional, default is empty.)
- serial (device ID of the serial source. Optional, default is empty.)
- groupname (the name of a channel group of which the created channel will be a member. Optional, default is empty.)

Output values:

- version - the current API version number
- timestamp - the current server time
- success (0 = fail, 1 = success)
- errors (if anything failed, details are returned here)
- id (the ID of the new channel, if it was created)

Examples

Input:

```
/api/?v=4&method=create_channel&token=xxxxx&name=my_channel&video1=21&audio=81&groupname=my_channel_group
```

Output:

```
<api_response>  
  <version>3</version>  
  <timestamp>2012-12-12 12:12:12</timestamp>  
  <success>1</success>  
  <id>91</success>  
</api_response>
```

delete_channel

This method was last updated in API version 4, and is compatible with API requests from version 4 onwards.

This function deletes a channel. The API user must have admin privileges to call this method successfully.

Input parameters:

- token
- v (the AIM API version this request is designed for)
- id (the ID of the channel to be deleted)

Output values:

- version - the current API version number
- timestamp - the current server time
- success (0 = fail, 1 = success)
- errors (if anything failed, details are returned here)

Examples

Input:

```
/api/?v=4&method=delete_channel&token=xxxxx&id=5
```

Output:

```
<api_response>  
  <version>4</version>  
  <timestamp>2012-12-12 12:12:12</timestamp>  
  <success>1</success>  
</api_response>
```

APPENDIX G - DHCP server requirements for ALIF support

Version 1.0

ALIF DHCP client

The ALIF DHCP client will identify itself to a DHCP server using DHCP option 60 (Vendor-Class-Identifier) containing the brand string appropriate to the firmware, e.g. Adder.

The ALIF DHCP client will also provide the DHCP server with its unique hostname and a request for DHCP option 125 (Vendor Identified Vendor Sub Options).

DHCP server

A DHCP server will use the Vendor-Class-Identifier to identify an ALIF and supply it with Adder vendor information encapsulated in the Adder Enterprise number (25119) within DHCP option 125 (Vendor Identified Vendor Sub Options).

As of ALIF firmware version 4.2, the required Adder vendor information to be encapsulated is:

Sub-option 1: Array of IP addresses of all AIM servers in the cluster.

Note: ALIF will ignore any DHCP OFFER not containing this information.

Example Gamma (Cisco IOS DHCPd, Adder, AIM servers: 10.0.20.5, 10.0.20.6)

```
ip dhcp pool vlan20
```

```
network 10.0.20.0 255.255.255.0
```

```
default-router 10.0.20.1
```

```
option 60 ascii "adder"
```

```
option 125 hex 0000.621f.0a01.080a.0014.050a.0014.06
```

where:

0x0000621f Adder Enterprise number (25119)

0x0a Length

0x01 Sub-option 1

0x08 Length

0x0a001405 10.0.20.5 (Primary AIM)

0x0a001406 10.0.20.6 (Backup AIM)

Example Alpha (ISC DHCPd, Adder, AIM servers: 10.0.20.5, 10.0.20.6)

```
# ISC DHCPd configuration for Adder
```

```
set vendor-string = option vendor-class-identifier;
option space adder code width 1 length width 1;
option adder.aim-servers code 1 = array of ip-address;
option space vivso code width 4 length width 1;
option vivso.iana code 0 = string;
option vivso.adder code 25119 = encapsulate adder;
option option-125 code 125 = encapsulate vivso;
default-lease-time 3600;
max-lease-time 7200;
log-facility local7;
class "adder"
{
    match if option vendor-class-identifier = "adder";
}
subnet 10.0.20.0 netmask 255.255.255.0
{
    pool
    {
        allow members of "adder";
        vendor-option-space adder;
        option domain-name "customer.com";
        option domain-name-servers 10.0.20.2;
        option routers 10.0.20.1;
        option vivso.iana 01:01:01;
        option adder.aim-servers 10.0.20.5,10.0.20.6;
        range 10.0.20.100 10.0.20.200;
    }
}
```

APPENDIX H - Technical specifications

Hardware

Industrial specification server with solid state memory

Software

Closed system with bespoke application preloaded

Physical design

1U short-depth (230mm) server

WxHxD: 16.93" x 1.75" x 9.05"
430mm x 44.5mm x 230mm

Weight: 5.95 lbs
2.7kg

Power

Input rating of server: 12VDC 2.0A

Power Adapter

Input: 100-240VAC 50/60Hz 1.5A

Output: 12VDC 5.0A

Connector: IEC input

Manufacturer: Stontronics model DSA-60PFB-12 I 120500 part number T5386DV

IMPORTANT: A defective power adapter MUST only be replaced with this make and model: Adder order code: PSU-IEC-12VDC-5A

Permitted operational ambient conditions

Operating temperature: 0 to 40°C / 32 to 104°F

Relative Humidity: 10-90% non-condensing

Permitted Altitude: <2000m

Approvals: CE, FCC

SAFETY INFORMATION

- For use in dry, oil free indoor environments only.
- Warning - live parts contained within power adapter.
- No user serviceable parts within power adapter - do not dismantle.
- Plug the power adapter into a socket outlet close to the module that it is powering.
- Replace a defective power adapter with a manufacturer approved type only - see the [Technical Specifications](#) section.
- Do not use the power adapter if the power adapter case becomes damaged, cracked or broken or if you suspect that it is not operating properly.
- Do not attempt to service the unit yourself.
- Not suitable for use in hazardous or explosive environments or next to highly flammable materials.
- If you use a power extension cable, make sure the total ampere rating of the devices plugged into the extension cable do not exceed the cable's ampere rating. Also, make sure that the total ampere rating of all the devices plugged into the wall outlet does not exceed the wall outlet's ampere rating.
- The power adapter can get warm in operation – do not situate it in an enclosed space without any ventilation.

LITHIUM BATTERY

CAUTION: This product contains a lithium battery which must be disposed of in the correct manner.

CAUTION: RISK OF EXPLOSION IF BATTERY IS REPLACED BY AN INCORRECT TYPE.

- If the lithium battery needs to be changed, you must return the product to your nearest Adder dealer. The battery must be replaced by an authorized Adder dealer.
- Once the product has come to the end of its useful life, the lithium battery must be removed as part of the decommissioning process and recycled in strict accordance with the regulations stipulated by your local authority. Advice on battery removal can be provided on request by Adder.

WARRANTY

Adder Technology Ltd warrants that this product shall be free from defects in workmanship and materials for a period of two years from the date of original purchase. If the product should fail to operate correctly in normal use during the warranty period, Adder will replace or repair it free of charge. No liability can be accepted for damage due to misuse or circumstances outside Adder's control. Also Adder will not be responsible for any loss, damage or injury arising directly or indirectly from the use of this product. Adder's total liability under the terms of this warranty shall in all circumstances be limited to the replacement value of this product.

If any difficulty is experienced in the installation or use of this product that you are unable to resolve, please contact your supplier.



RADIO FREQUENCY ENERGY

All interface cables used with this equipment must be shielded in order to maintain compliance with radio frequency energy emission regulations and ensure a suitably high level of immunity to electromagnetic disturbances.

European EMC directive 2004/108/EC

This equipment has been tested and found to comply with the limits for a class A computing device in accordance with the specifications in the European standard EN55022. These limits are designed to provide reasonable protection against harmful interference. This equipment generates, uses and can radiate radio frequency energy and if not installed and used in accordance with the instructions may cause harmful interference to radio or television reception. However, there is no guarantee that harmful interference will not occur in a particular installation. If this equipment does cause interference to radio or television reception, which can be determined by turning the equipment on and off, the user is encouraged to correct the interference with one or more of the following measures: (a) Reorient or relocate the receiving antenna. (b) Increase the separation between the equipment and the receiver. (c) Connect the equipment to an outlet on a circuit different from that to which the receiver is connected. (d) Consult the supplier or an experienced radio/TV technician for help.

FCC Compliance Statement (United States)

This equipment generates, uses and can radiate radio frequency energy and if not installed and used properly, that is, in strict accordance with the manufacturer's instructions, may cause interference to radio communication. It has been tested and found to comply with the limits for a class A computing device in accordance with the specifications in Subpart J of part 15 of FCC rules, which are designed to provide reasonable protection against such interference when the equipment is operated in a commercial environment. Operation of this equipment in a residential area may cause interference, in which case the user at his own expense will be required to take whatever measures may be necessary to correct the interference. Changes or modifications not expressly approved by the manufacturer could void the user's authority to operate the equipment.

Canadian Department of Communications RFI statement

This equipment does not exceed the class A limits for radio noise emissions from digital apparatus set out in the radio interference regulations of the Canadian Department of Communications.

Le présent appareil numérique n'émet pas de bruits radioélectriques dépassant les limites applicables aux appareils numériques de la classe A prescrites dans le règlement sur le brouillage radioélectriques publié par le ministère des Communications du Canada.

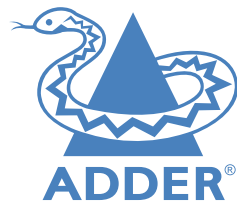

Web: www.adder.com

Contact: www.adder.com/contact-details

Support: www.adder.com/support

A

Active Directory 4,37

B

Base DN 18

Browsers
supported 9

C

Cable spec
null modem 46

Channel
add channel group 25
configure channel group 25

Channels
add a channel 24
configure a channel 24
view channels page 23
what are they? 3

Channels tab 23

Connections
transmitter - power in 6

D

Dashboard
active connections page 22
backups page 19
connection log page 22
event log page 22
home page 12
settings page 13
updates page 20
Dashboard tab 12
Distinguished Name 18

F

Factory reset 11
Favorites 41
Firmware (A.I.M.)
upgrade/downgrade 20,21
Frame Skipping 31

G

Groups
what are they? 3

H

Hotkey settings 15
Hotkey shortcuts 41

I

IP port
connecting 6

L

LDAP 18
Logging in
administrators 9
normal users 41

N

Network ports
configuration 16

O

On-Screen Display 3,41,42,43
OSD 3
login 41
main screen 42
remote 43
shortcuts 41

P

Permissions 4
Portfast 53
Presets 38
add presets page 39
configure presets page 39
Presets tab 38

R

Receivers
add receiver group page 29
configure group page 29
configure receiver page 27
view receivers page 26
Receivers tab 26
Redundant servers
setting up 49
Regular user 3
Relationship
three-way 3
Remote OSD 43
Remote support 22
Reset
manual 11

S

Safety information 67
Search filters 23
Security 3
Server redundancy 49
Servers tab 33
Shortcuts 41
Specifications 66
Statistics tab 40
Swapping an AIM server 49

T

Technical specifications 65,66
Transmitters
configure transmitter page 31
update firmware 31
view transmitters page 30
Transmitters tab 30
Troubleshooting 44

U

Users
active directory 37
add user group page 36
add user page 35
configure group page 36
configure user page 35
view users page 34
Users tab 34