

	A	B	C	D	E
1	1x	2x	8x M4 x 10mm	1x	1x 4mm
2			8x M4 x 10mm	1x	1x 2.5mm
3		1x 2x	2x M3 x 6mm	2x	4x
4	1x	3x 2x	1x	2x	2x

For the latest User Installation Guide please visit: www.ergotron.com



User's Guide - English
 Guía del usuario - Español
 Manuel de l'utilisateur - Français
 Gebrauchersgids - Deutsch
 Benutzerhandbuch - Nederlands
 Guida per l'utente - Italiano
 Användarhandbok - svenska
 ユーザーガイド : 日本語
 用户指南 : 汉语







Includes
 Constant Force™
 Technology



www.ergotron.com
 USA 1-800-888-8458
 Europe +31 (0)33-45 45 600
 China 86-769-86018920

Hazard Symbols Review

These symbols alert users of a safety condition that demands attention. All users should be able to recognize and understand the significance of the following Safety Hazards if encountered on the product or within the documentation. Children who are not able to recognize and respond appropriately to Safety Alerts should not use this product without adult supervision!

Symbol	Signal Word	Level of Hazard
	NOTE	A NOTE indicates important information that helps you make better use of this product.
	CAUTION	A CAUTION indicates either potential damage to hardware or loss of data and tells you how to avoid the problem.
	WARNING	A WARNING indicates either potential for property damage, personal injury, or death.
	ELECTRICAL	An Electrical indicates an impending electrical hazard which, if not avoided, may result in personal injury, fire and/or death.

Safety



Important! You will need to adjust this product after installation is complete. Make sure all your equipment is properly installed on the product before attempting adjustments. This product should move smoothly and easily through the full range of motion and stay where you set it. If movements are too easy or difficult or if product does not stay in desired positions, follow the adjustment instructions to create smooth and easy movements. Depending on your product and the adjustment, it may take many turns to notice a difference. Any time equipment is added or removed from this product, resulting in a change in the weight of the mounted load, you should repeat these adjustment steps to ensure safe and optimum operation.

 **Warning:** Because mounting surface materials can vary widely, it is imperative that you make sure mounting surface is strong enough to handle mounted product and equipment.

 **Caution:** To avoid the potential to pinch cables it is important to follow the cable routing instructions in this manual. Failure to follow these instructions may result in equipment damage or personal injury.

Choose Mounting Method

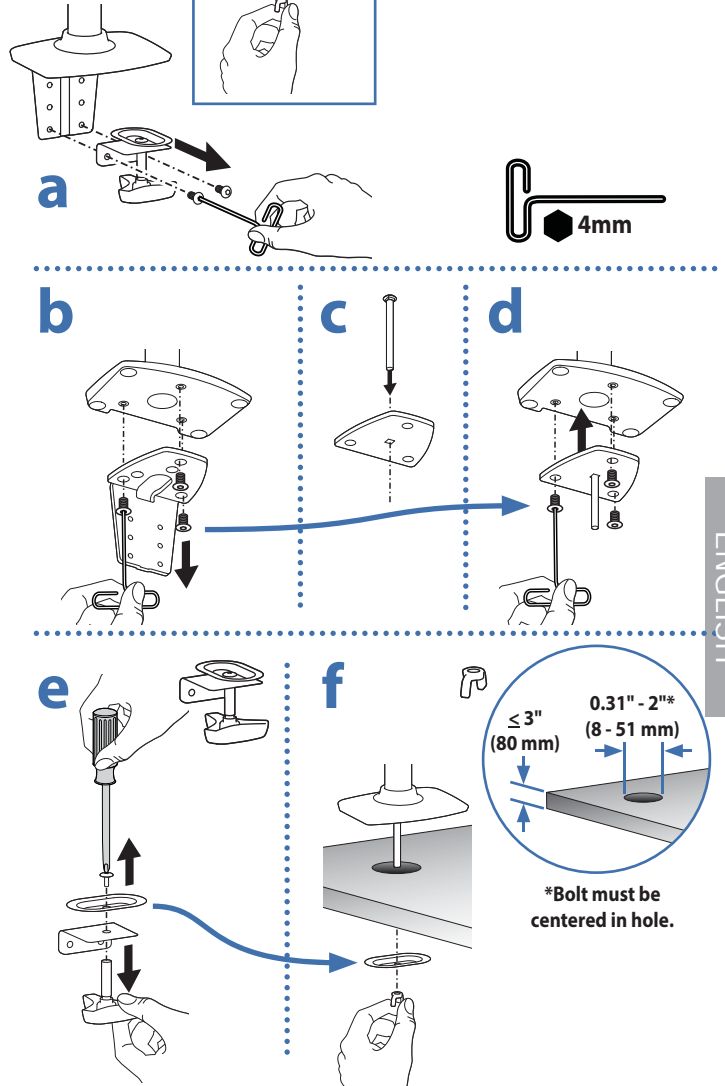
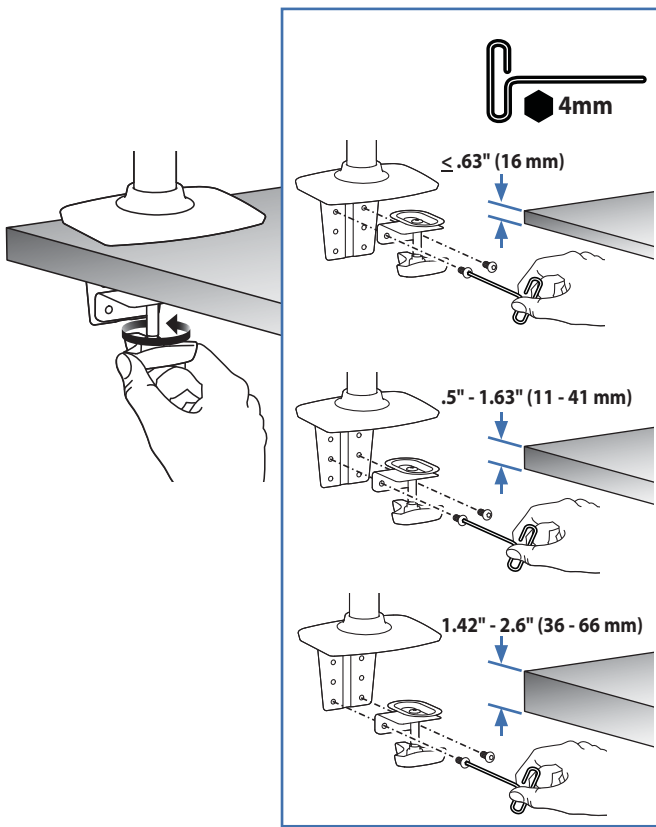
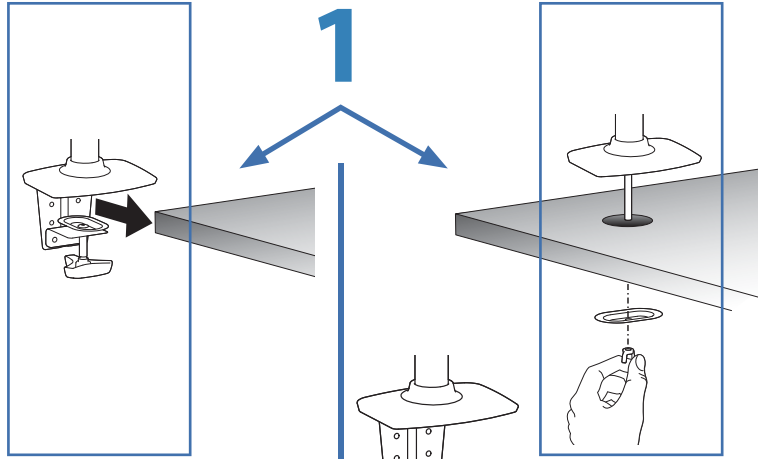

ENGLISH

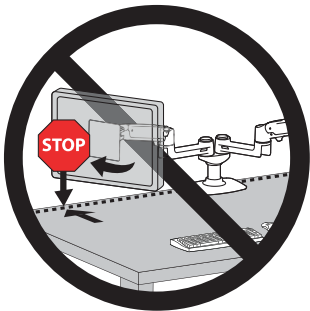

CAUTION: For Desk Clamp installations: Do Not rotate display past edge of desk



CAUTION: For secure arm attachment and to avoid equipment damage, plate must make contact with underside of desk on both sides of the hole.

2 Attach Display

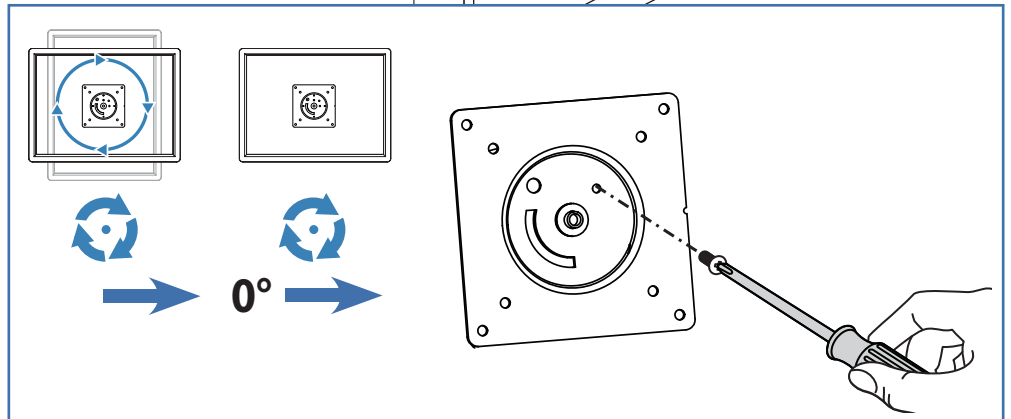
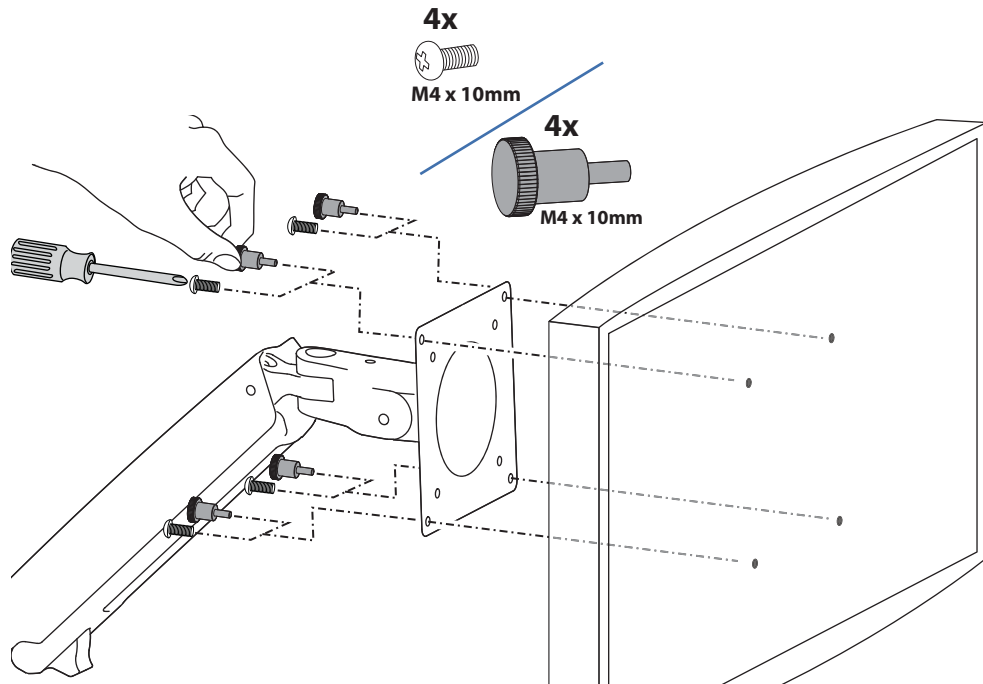

WARNING! Stored Energy Hazard: The arm mechanism is under tension and will move up rapidly, on its own, as soon as attached equipment is removed. For this reason, **DO NOT** remove equipment unless the arm has been moved to the highest position! Failure to follow this instruction may result in serious personal injury and/or equipment damage!

2 Attach Notebook

a

 Attach portrait/landscape rotation stop screw

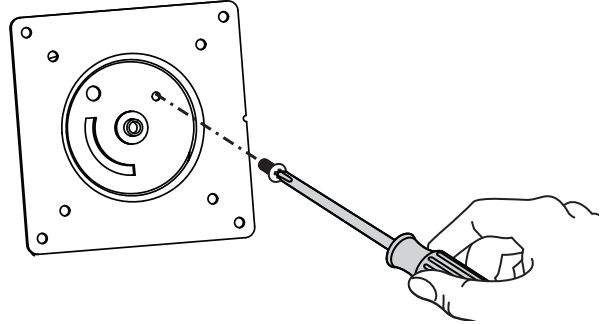

b

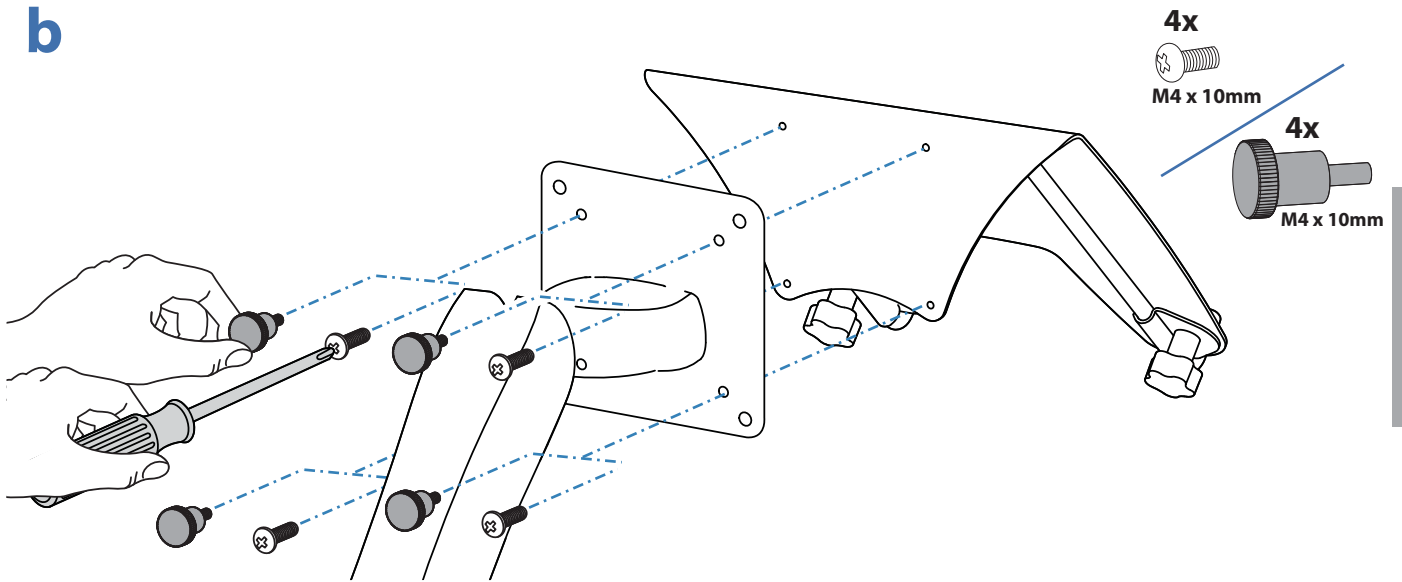

c

A Place Notebook

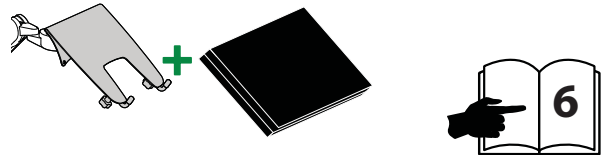

B Place docking station and notebook

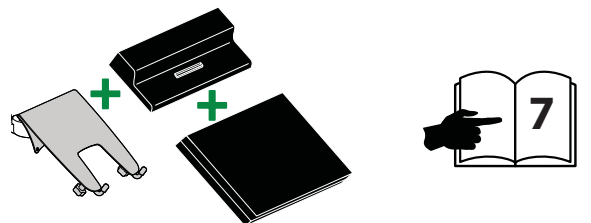

A

Place Notebook



Pads will help prevent notebook from slipping, but they will not hold all notebooks on the tray in all circumstances. Use caution while tilting the tray, since some angles may cause the notebook to fall off resulting in equipment damage or personal injury.

2x

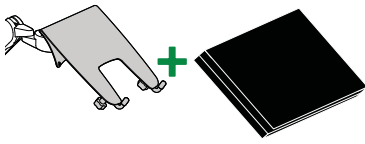

a

2x

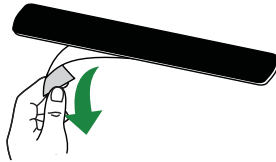

b

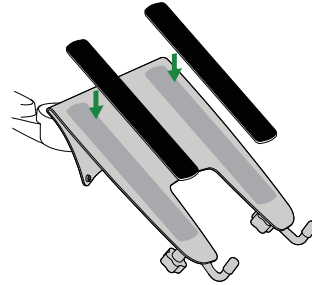

c

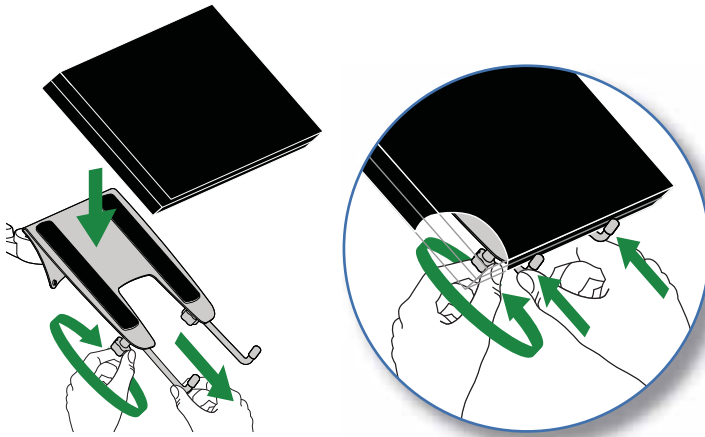

ENGLISH

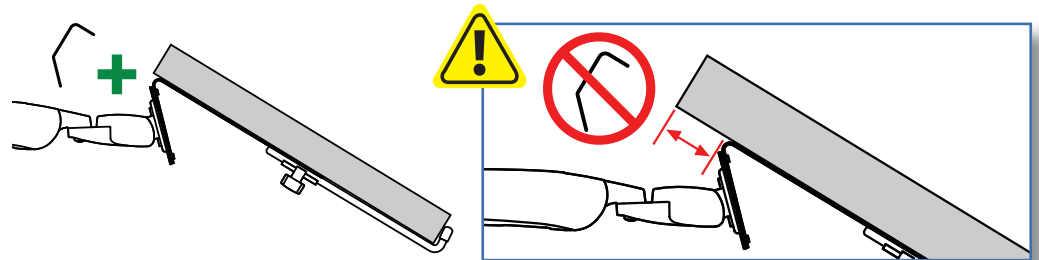

d 1x

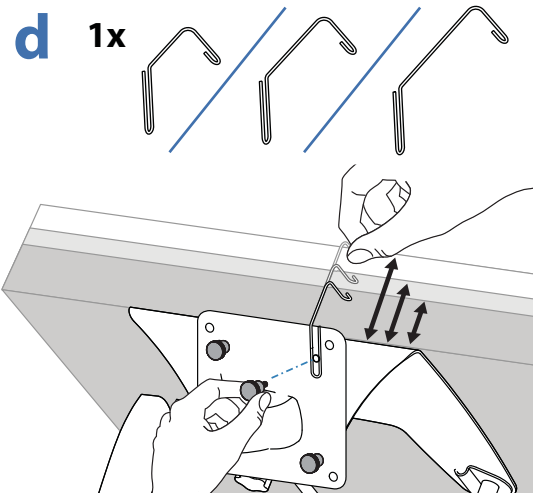

e 1x

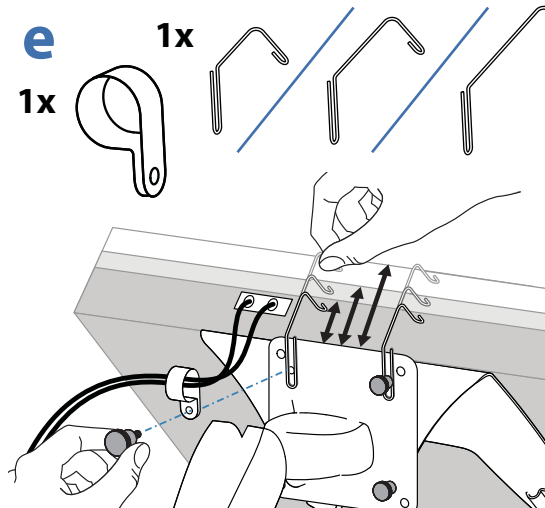

f

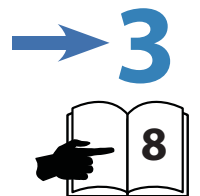

B

Place docking station and notebook

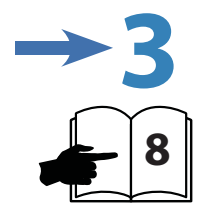
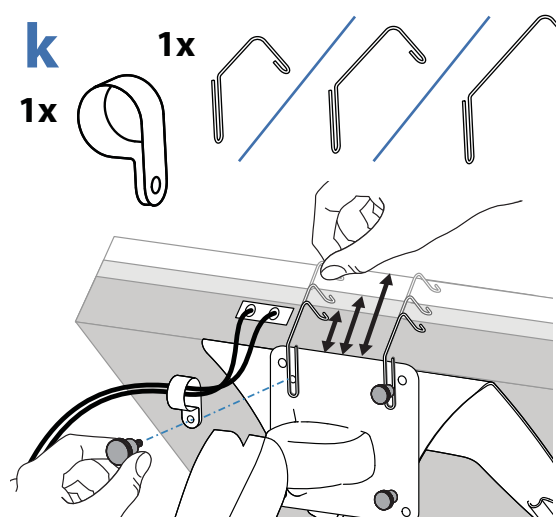
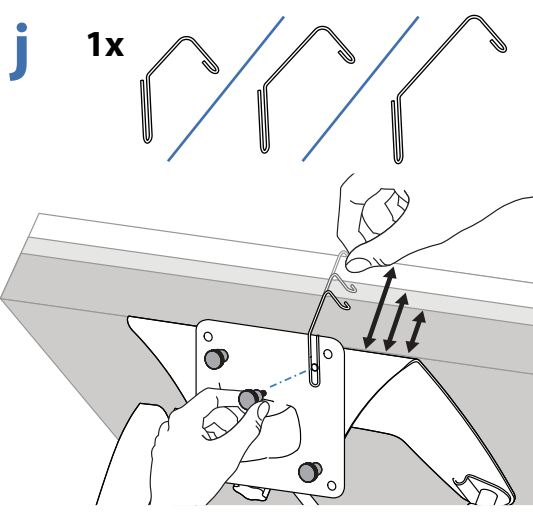
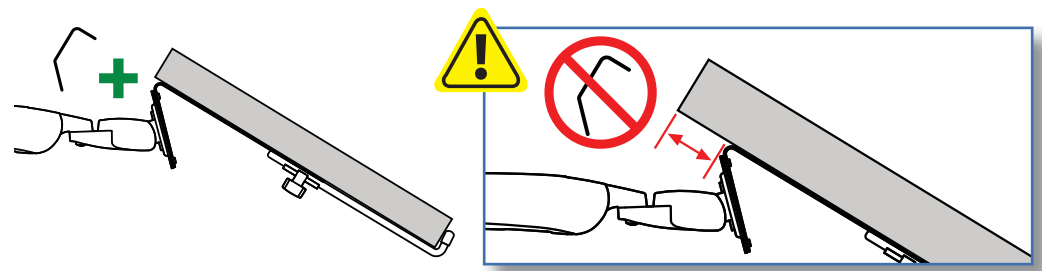
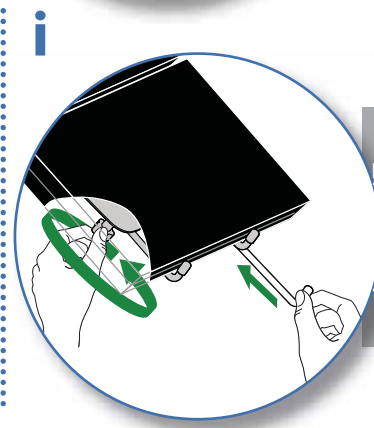
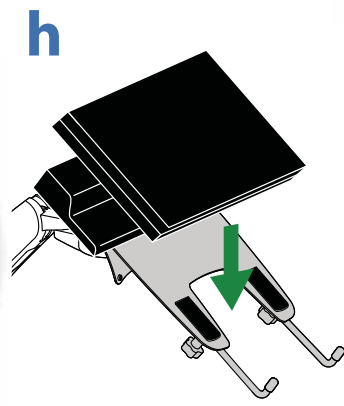
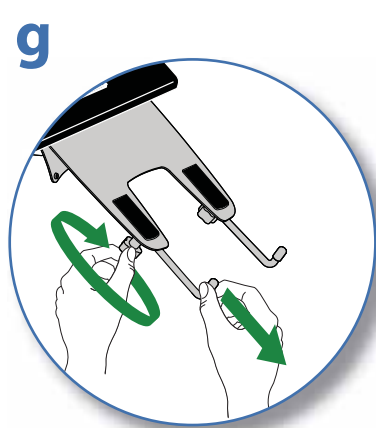
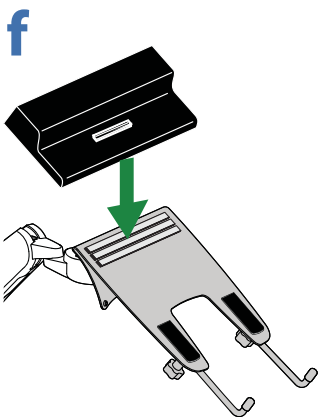
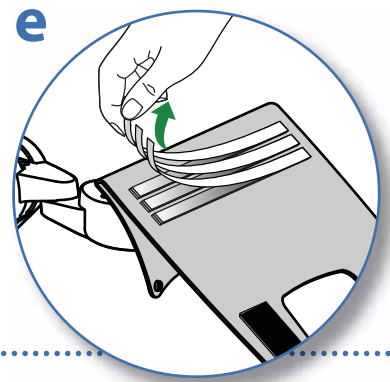
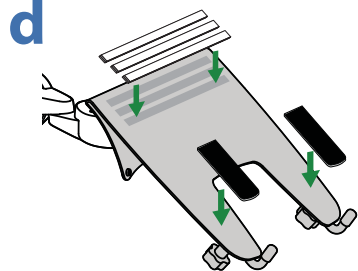
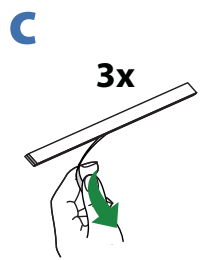
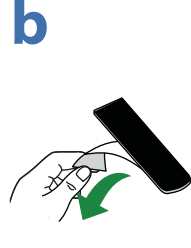
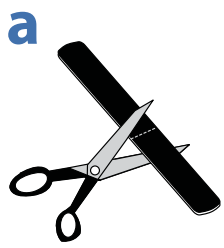
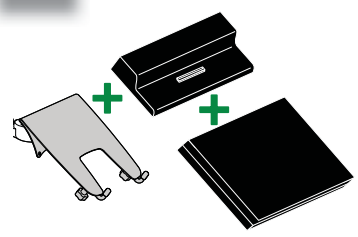
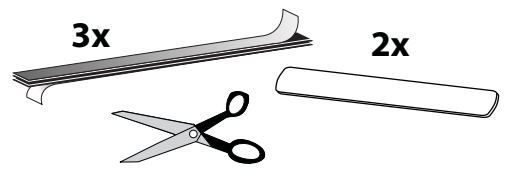

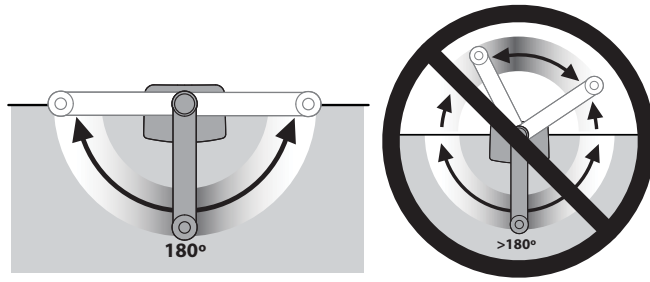

⚠ WARNING: Desk Clamp Installations: The range of motion (side-to-side) for two Extensions/Arms on one pole mounted with the Desk Clamp option is limited to 180° forward (over front of desk clamp base). **NOTE:** Grommet Mount Installations: The range of motion (side-to-side) for two Extensions/Arms on one pole mounted with the Grommet Mount option is 360°

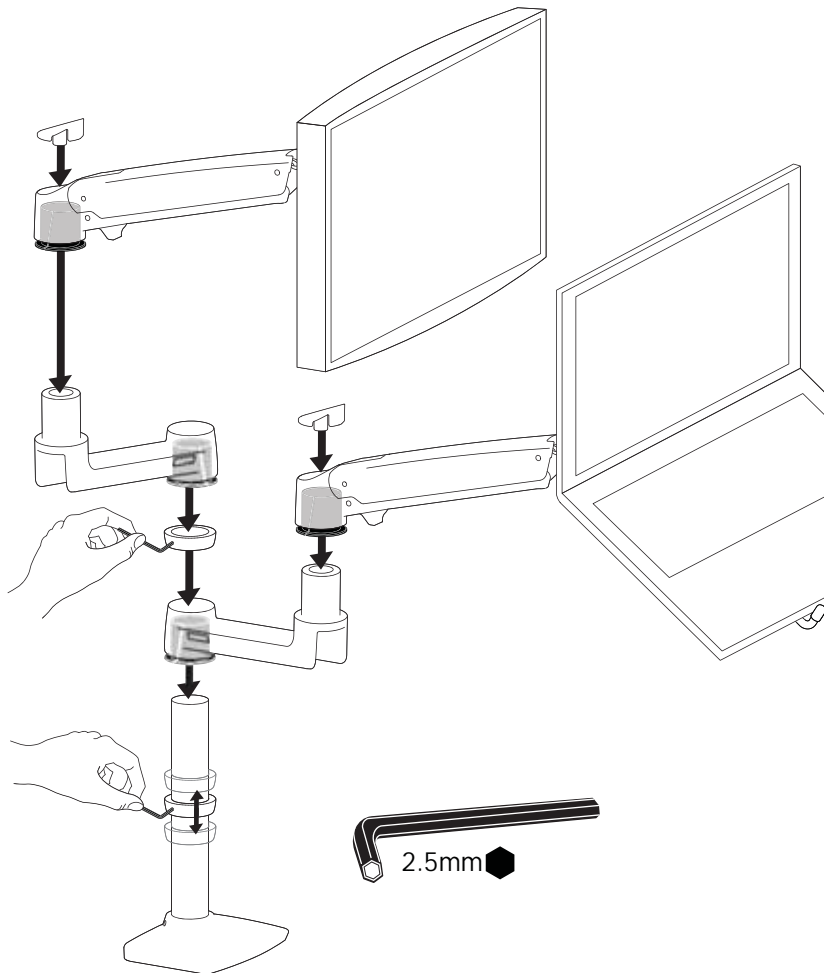

4



NOTE: Leave enough slack in cable to allow full range of motion.



Caution: To avoid the potential to pinch cables it is important to follow the cable routing instructions in this manual. Failure to follow these instructions may result in equipment damage or personal injury.

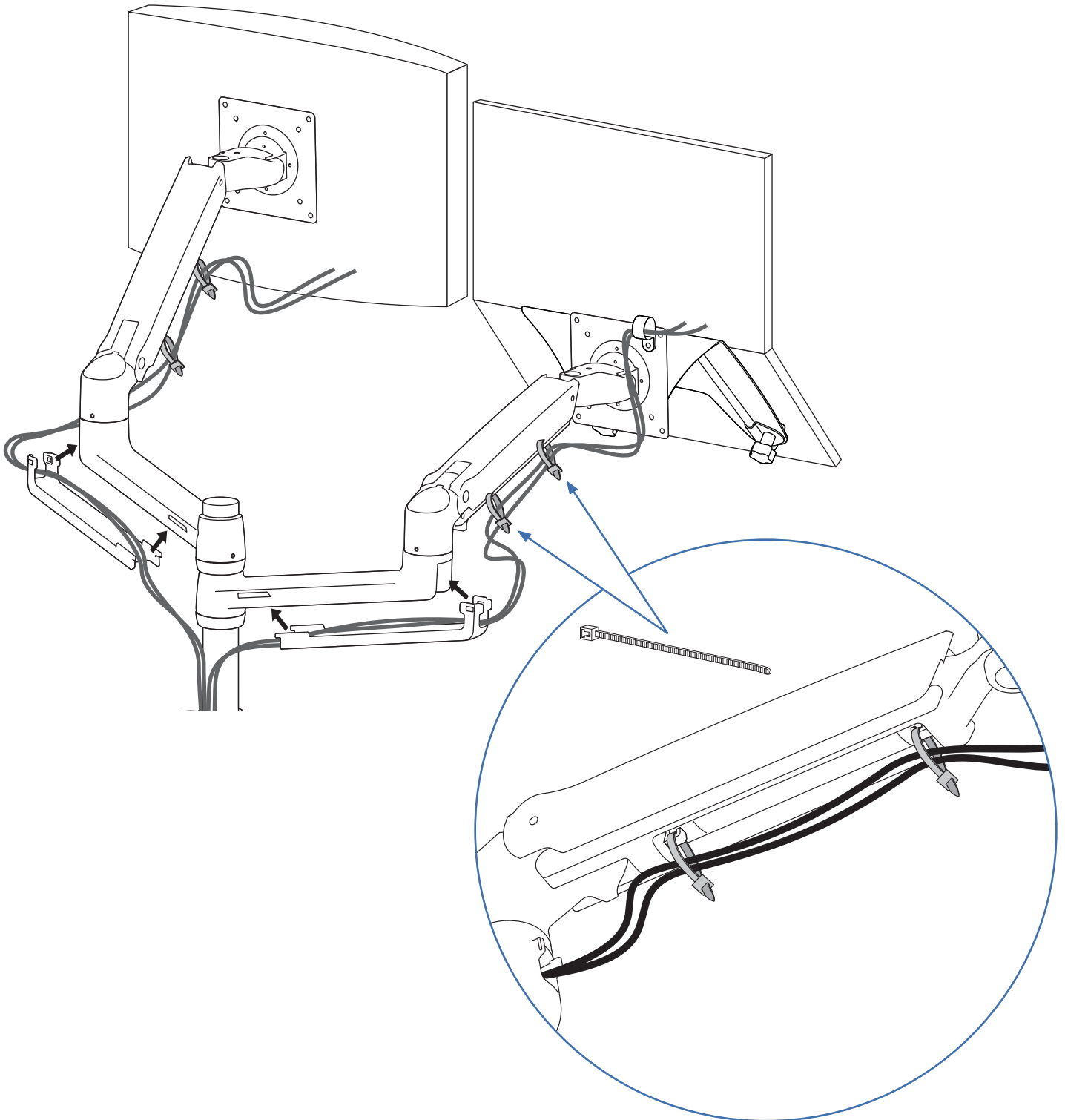

5 Important! You will need to adjust this product after installation is complete. Make sure all your equipment is properly installed on the product before attempting adjustments. This product should move smoothly and easily through the full range of motion and stay where you set it. If movements are too easy or difficult or if product does not stay in desired positions, follow the adjustment instructions to create smooth and easy movements. Depending on your product and the adjustment, it may take many turns to notice a difference. Any time equipment is added or removed from this product, resulting in a change in the weight of the mounted load, you should repeat these adjustment steps to ensure safe and optimum operation.

a Lift – Up and down

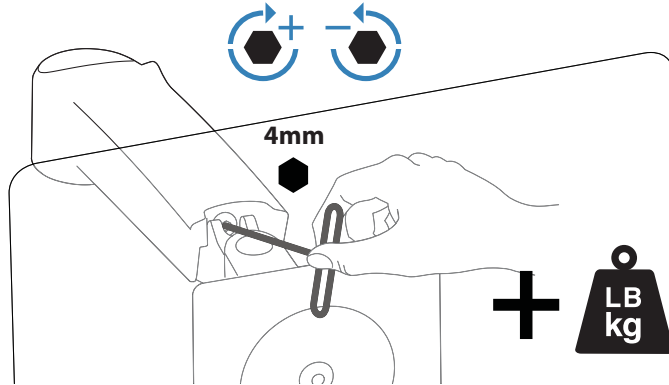
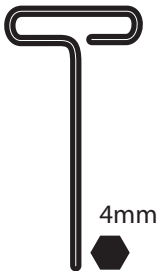
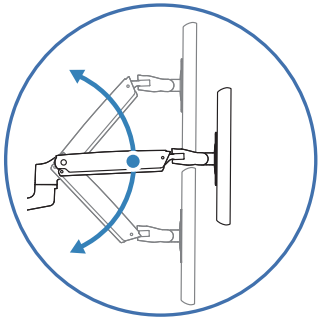

CAUTION: DO NOT overtighten fasteners. Overtightening may cause damage to your equipment.

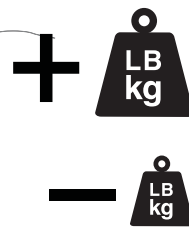

Increase Lift Strength

If the mounted weight is too heavy or this product does not stay up when raised, then you'll need to increase Lift Strength:

Decrease Lift Strength

If the mounted weight is too light or this product does not stay down when lowered, then you'll need to decrease Lift Strength:

b Tilt – Forward and Backward

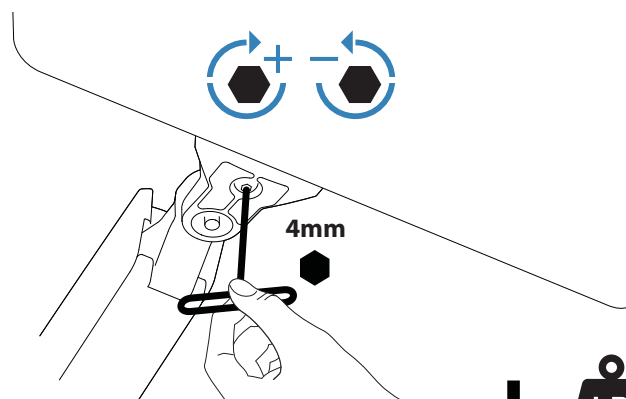
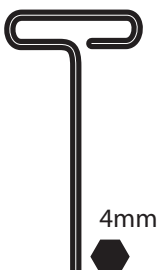
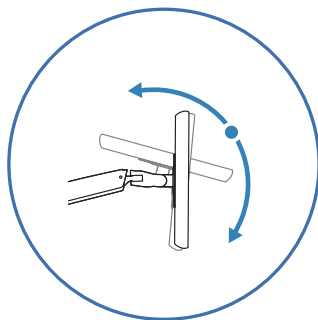

CAUTION: DO NOT remove screw. Removing screw may cause damage to equipment.



Increase Friction

If this product moves too easily, then you'll need to increase friction:



Decrease Friction

If this product is too difficult to move, then you'll need to decrease friction:



C Tilt – Forward and Backward

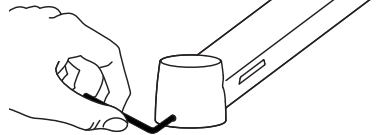
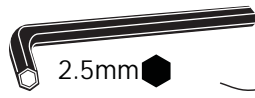
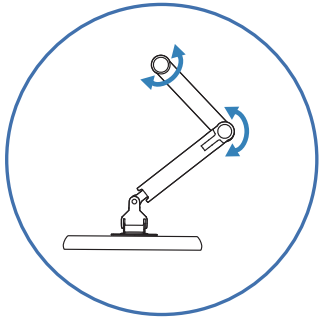

Increase Friction

If this product moves too easily, then you'll need to increase friction:



CAUTION: DO NOT remove screw. Removing screw may cause damage to equipment.



Decrease Friction

If this product is too difficult to move, then you'll need to decrease friction:



d Rotate – Portrait/Landscape

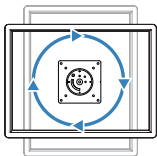

360°

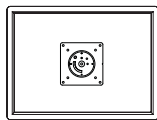

0°

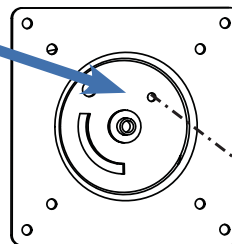

M3 x 6mm

6 Set Your Workstation to Work For YOU!

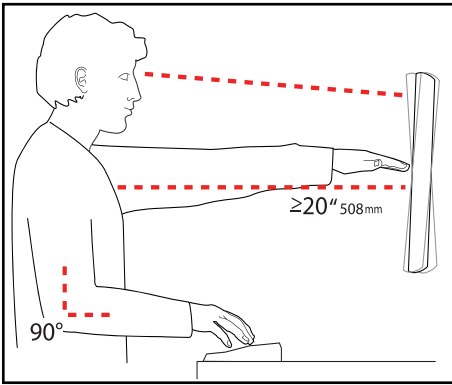

Learn more about ergonomic computer use at:
www.computingcomfort.org

- Height** Position top of screen slightly below eye level.
Position keyboard at about elbow height with wrists flat.
- Distance** Position screen an arm's length from face—at least 20" (508mm).
Position keyboard close enough to create a 90° angle in elbow.
- Angle** Tilt screen to eliminate glare.
Tilt the keyboard back 10° so that your wrists remain flat.

- To Reduce Fatigue**
Breathe - Breathe deeply through your nose.
Blink - Blink often to avoid dry eyes.
Break • 2 to 3 minutes every 20 minutes
• 15 to 20 minutes every 2 hours.

For service and warranty visit www.ergotron.com

For local customer care phone numbers visit: <http://contact.ergotron.com>



NOTE: When contacting customer service, reference the serial number.

ENGLISH

Americas Sales and Corporate Headquarters

1181 Trapp Rd.
St. Paul, MN USA
(800) 888-8458
+1-651-681-7600
www.ergotron.com
sales@ergotron.com

EMEA Sales

Amersfoort, The Netherlands
+31 33 45 45 600
www.ergotron.com
info.eu@ergotron.com

APAC Sales

Tokyo, Japan
www.ergotron.com
apaccustomerservice@ergotron.com

Worldwide OEM Sales

www.ergotron.com
info.oem@ergotron.com



© 2014 Ergotron, Inc.
All rights reserved.

While Ergotron, Inc. makes every effort to provide accurate and complete information on the installation and use of its products, it will not be held liable for any editorial errors or omissions (including those made in the process of translation from English to another language), or for incidental, special or consequential damages of any nature resulting from furnishing this instruction and performance of equipment in connection with this instruction. Ergotron, Inc. reserves the right to make changes in the product design and/or product documentation without notification to its users. For the most current product information, or to know if this document is available in languages other than those herein, please contact Ergotron. No part of this publication may be reproduced, stored in a retrieval system, or transmitted in any form or by any means, electronic, mechanical, photocopying, recording or otherwise without the prior written consent of Ergotron, Inc., 1181 Trapp Road, Eagan, Minnesota, 55121, USA. Patents Pending and Patented U.S. & Foreign. Ergotron is a registered trademark of Ergotron, Inc.