



KRAMER ELECTRONICS LTD.

USER MANUAL

MODEL:

VP-790

Genlock Presentation
Switcher/Scaler

P/N: 2900-300093 Rev 5



VP-790 Quick Start Guide

This guide helps you install and use your product for the first time. For more detailed information, go to http://www.kramerelectronics.com/support/product_downloads.asp to download the latest manual or scan the QR code on the left.

Step 1: Check what's in the box

- The **VP-790** Genlock Presentation Switcher/Scaler
- IR remote control transmitter with batteries
- 1 Power cord
- 1 Quick start guide
- 1 Set of ear racks
- 4 Rubber feet

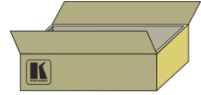

Save the original box and packaging materials in case you need to return your product for service.

Step 2: Install the VP-790

Mount the machine in a rack or place on a table.

Step 3: Connect inputs and outputs

Always switch OFF the power on each device before connecting it to your **VP-790**.

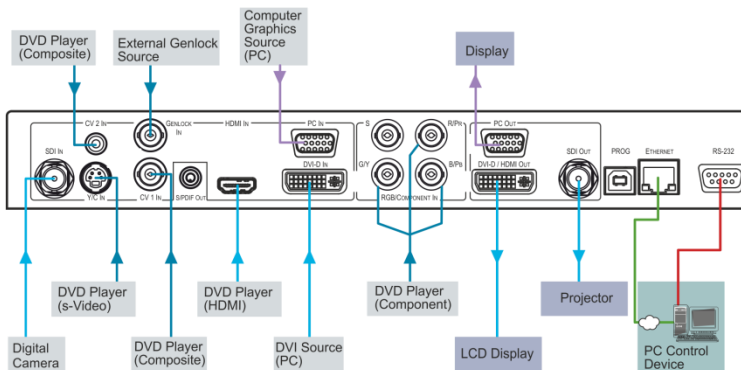

For best results, we recommend that you always use Kramer high-performance cables to connect AV equipment to the **VP-790**.

Step 4: Connect the power

Connect AC power to the rear of the **VP-790**, switch on its power and then switch on the power on each device.

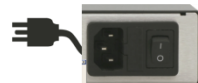

Step 5: Operate via the front panel buttons and the remote control transmitter

Push the MENU button to access the menu and show the main menu screen on your display or projector.

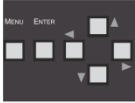

The MENU button shows the main OSD menu. The arrow buttons and ENTER button let you navigate within the OSD menu

If you cannot see any images, verify that the output cable to your display, TV, or projector is in good working order and is connected to the **VP-790**.

If you still don't see an image, press and hold the **RESET TO XGA/720P** button for a second to reset the output to XGA (1024x768) resolution. Push the MENU button again and the main menu should appear on the screen.

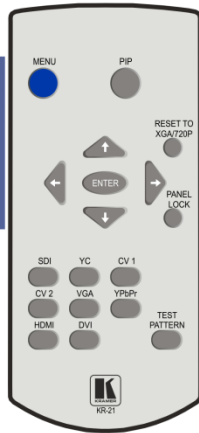

Press the PIP button and then an input button to select the PIP source

Press and hold to reset to the default resolution (helpful if you fail to see the input signal on the display)



Press one of the nine Main Source buttons (including the Test Pattern input) to select an input signal



Step 6. Configure the VP-790

Push the MENU button to access the OSD menu and select the Operation Mode via the Setup menu.

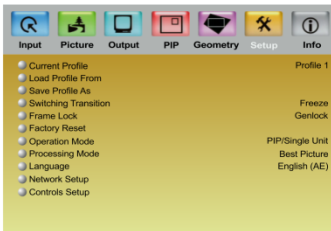

Configure the **VP-790** as desired

PIP/Single Unit: Select the single unit mode if the output is a single unit. The system reboots to the single unit mode and the PIP menu becomes active.

Multiunit: Select the Multiunit mode if the output channel is part of a matrix with multiple displays. The system reboots to the multiunit mode and the Multiunit menu becomes active.

Contents

1	Introduction	1
2	Getting Started	2
2.1	Achieving the Best Performance	2
2.2	Safety Instructions	2
2.3	Recycling Kramer Products	3
3	Overview	4
3.1	Using the IR Transmitter	6
3.2	Defining the VP-790 Genlock Presentation Switcher/Scaler	6
4	Installing in a Rack	9
5	Connecting the VP-790	10
6	Configuring the VP-790 via the OSD MENU Screens	12
6.1	The Input Screen	13
6.2	The Picture Screen	15
6.3	The Output Screen	16
6.4	The PIP Screen	19
6.5	The Multi-unit Screen	21
6.6	The Geometry Screen	24
6.7	The Setup Screen	25
6.8	The Info Screen	27
7	Controlling the VP-790	28
7.1	Controlling via the Front Panel Buttons	28
7.2	Connecting to the Product via RS-232	28
7.3	Operating via Ethernet	29
7.4	Controlling via the Infrared Remote Control Transmitter	35
8	Firmware Upgrade	36
8.1	Installing the VP-790 Updater Tool	36
8.2	Saving User Settings	39
8.3	Updating the Firmware	39
9	Technical Specifications	41
9.1	Input Resolutions	41
9.2	Output Resolutions	42
9.3	RS-232 Communication Protocol	43

Figures

Figure 1: VP-790 Genlock Presentation Switcher/Scaler Front Panel	7
Figure 2: VP-790 Genlock Presentation Switcher/Scaler Rear Panel	8
Figure 3: Connecting the VP-790 Genlock Presentation Switcher/Scaler	11
Figure 4: MENU Items	12
Figure 5: Input Screen	13
Figure 6: Picture Screen	15
Figure 7: Output Screen	16
Figure 8: PIP Screen	19
Figure 9: Audio Screen	22
Figure 10: Geometry Screen	24
Figure 11: Setup Screen	25
Figure 12: Information Screen	27
Figure 13: Local Area Connection Properties Window	30
Figure 14: Internet Protocol Version 4 Properties Window	31
Figure 15: Internet Protocol Version 6 Properties Window	31
Figure 16: Internet Protocol Properties Window	32
Figure 17: Web Browser Address Bar	33
Figure 18: Web Browser Address Bar	33
Figure 19: Infrared Remote Control Transmitter	35
Figure 20: Welcome Window	36
Figure 21: Choose Destination Location Window	37
Figure 22: Confirm Installation	37
Figure 23: Installation Progress Window	38
Figure 24: Installation Complete Window	38
Figure 25: Updater Tool Window	39

1 Introduction

Welcome to Kramer Electronics! Since 1981, Kramer Electronics has been providing a world of unique, creative, and affordable solutions to the vast range of problems that confront the video, audio, presentation, and broadcasting professional on a daily basis. In recent years, we have redesigned and upgraded most of our line, making the best even better!

Our 1,000-plus different models now appear in 14 groups that are clearly defined by function: GROUP 1: Distribution Amplifiers; GROUP 2: Switchers and Routers; GROUP 3: Control Systems; GROUP 4: Format/Standards Converters; GROUP 5: Range Extenders and Repeaters; GROUP 6: Specialty AV Products; GROUP 7: Scan Converters and Scalers; GROUP 8: Cables and Connectors; GROUP 9: Room Connectivity; GROUP 10: Accessories and Rack Adapters; GROUP 11: Sierra Video Products; GROUP 12: Digital Signage; GROUP 13: Audio; and GROUP 14: Collaboration.

Congratulations on purchasing your Kramer **VP-790 Genlock Presentation Switcher/Scaler**. This product, which incorporates HDMI™ technology, is ideal for:

- Projection systems in conference rooms, boardrooms, auditoriums, hotels and churches, production studios, rental and staging
- Any application where high quality conversion and switching of multiple and different video signals to graphical data signals is required for projection purposes
- Large screen displays and multiple screen applications from video or graphic sources

In addition to this user manual these online guides are available for download from our Web site:

- Warp Generator online guide
- Blending Guides
- RS-232 Protocol online guide

These software programs are available for download from our Web site:

- **VP-790 Updater Tool**
- Warp Generator

2 Getting Started

We recommend that you:

- Unpack the equipment carefully and save the original box and packaging materials for possible future shipment
- Review the contents of this user manual



Go to http://www.kramerelectronics.com/support/product_downloads.asp to check for up-to-date user manuals, application programs, and to check if firmware upgrades are available (where appropriate).

2.1 Achieving the Best Performance

To achieve the best performance:

- Use only good quality connection cables (we recommend Kramer high-performance, high-resolution cables) to avoid interference, deterioration in signal quality due to poor matching, and elevated noise levels (often associated with low quality cables)
- Do not secure the cables in tight bundles or roll the slack into tight coils
- Avoid interference from neighboring electrical appliances that may adversely influence signal quality
- Position your Kramer **VP-790** away from moisture, excessive sunlight and dust



This equipment is to be used only inside a building. It may only be connected to other equipment that is installed inside a building.

2.2 Safety Instructions



Caution: There are no operator serviceable parts inside the unit

Warning: Use only the power cord that is supplied with the unit

Warning: Do not open the unit. High voltages can cause electrical shock! Servicing by qualified personnel only

Warning: Disconnect the power and unplug the unit from the wall before installing

2.3 Recycling Kramer Products

The Waste Electrical and Electronic Equipment (WEEE) Directive 2002/96/EC aims to reduce the amount of WEEE sent for disposal to landfill or incineration by requiring it to be collected and recycled. To comply with the WEEE Directive, Kramer Electronics has made arrangements with the European Advanced Recycling Network (EARN) and will cover any costs of treatment, recycling and recovery of waste Kramer Electronics branded equipment on arrival at the EARN facility. For details of Kramer's recycling arrangements in your particular country go to our recycling pages at <http://www.kramerelectronics.com/support/recycling/>.

3 Overview

The **VP-790** is a proscale genlock presentation scaler/switcher with edge blending, warping and genlocking. The unit includes a powerful software tool to generate custom warp maps to fit any projection surface.

The unit takes one of the input signals (RGB component, computer graphics, composite, s-Video, HDMI, DVI or 3G HD-SDI), scales the video, embeds the audio and outputs the signal to the computer graphics, DVI/HDMI and 3G-SDI outputs simultaneously.

The **VP-790** features:

- HQV® Video Processing - HQV (Hollywood Quality Video) processing represents the state-of-the-art in video processing technology, with the highest quality de-interlacing (with 3:2 and 2:2 pull down), noise reduction, and scaling performance for both standard-definition and high-definition signals
- Flexible warp mapping for curved screen projection, simulation and 3D alignment
- Edge Blending – facilitates building large images using multiple projectors by feathering the overlapped edges
- A maximum data rate of 3Gbps
- 3G-SDI, HDMI, DVI, VGA Analog, Component YPbPr, RGsB/RGBS, Composite and s-Video inputs with signal compatibility up to 1080p and WUXGA
- HDTV Compatibility
- Genlock Input - ideal for use in broadcast video applications
- HDCP Compliance. The HDCP (High Definition Content Protection) license agreement allows copy-protected data on the HDMI input to pass only to the HDMI output.

Three output connectors are provided which can be used simultaneously, provided that the input signal is not HDCP encrypted. When the input signal has HDCP encryption, the DVI-D output connector will carry a similarly HDCP encrypted signal and the VGA and 3G-SDI connector will be disabled

- K-Storm™ Scaling Technology - Kramer's extremely high performance scaling technology. High quality 3:2 and 2:2 pull down de-interlacing and full up and down scaling of computer graphics video input signals
- 4D Motion, Noise Adaptive HQV noise reduction for spatial and temporal noise
- Genlock and frame lock options, making the unit ideal for broadcast applications
- DVI/HDMI, 3G HD-SDI and computer graphics video (15-pin HD) scaled outputs
DVI/HDMI supports HDMI with 36-bit video and multi-channel audio (DTS6.1, Dolby5.1 and PCM Multichannel (8x) at 48kHz)
- SD-SDI, HD-SDI and 3G-SDI that support SMPTE 259M, SMPTE 292M and SMPTE 424M compliancy
Standard Definition (SD-SDI) means an NTSC or PAL compatible video format, consisting of 480 (for NTSC) or 576 (for PAL) lines of interlaced video
High Definition (HD-SDI) means a video format, consisting of 720 active lines of progressive video or 1080 lines of progressive or interlaced video
3G-SDI means a video format, consisting of 1080 lines of progressive video
- An S/PDIF audio output, de-embedded from HDMI
- Multiple aspect ratio selections: standard, full screen, crop and anamorphic
- 4-field full resolution SD and HD processing
- A USB port for in-field firmware updates
- Built-in ProcAmp - Color, hue, sharpness, noise, contrast, and brightness
- Front panel buttons, including menu, test pattern, PIP and Reset to XGA/720p buttons
- Scales and zooms (to up to 400% of the original size)
- Non-volatile memory that retains the last settings used
- Front panel lockout, as well as input lock and save lock features via the OSD

Control your **VP-790** directly via the front panel push buttons, or:

- By RS-232 serial commands transmitted by a touch screen system, PC, or other serial controller
- Remotely, from the infrared remote control transmitter (with on-screen menus)
- Via the Ethernet

The **VP-790** is housed in a 19" 1U rack mountable enclosure, with rack "ears" included and is fed from a 100-240 VAC universal switching power supply.

3.1 Using the IR Transmitter

You can use the IR transmitter to control the machine via the built-in IR receiver on the front panel or, instead, via an optional external IR receiver (Model: C-A35M/IRR-50). The external IR receiver can be located up to 15 meters away from the machine. This distance can be extended to up to 60 meters when used with three extension cables (Model: C-A35M/A35F-50).

Before using the external IR receiver, be sure to arrange for your Kramer dealer to insert the internal IR connection cable (P/N: 505-70434010-S) with the 3.5mm connector that fits into the REMOTE IR opening on the rear panel. Connect the external IR receiver to the REMOTE IR 3.5mm connector.

3.2 Defining the VP-790 Genlock Presentation Switcher/Scaler

This section defines the **VP-790**.

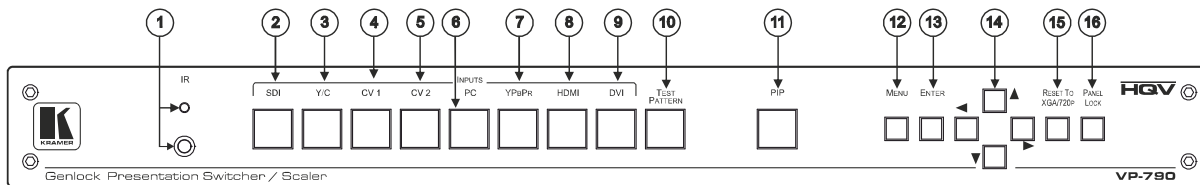

Figure 1: VP-790 Genlock Presentation Switcher/Scaler Front Panel

#	Feature	Function	
1	IR Receiver	Receives signals from the remote control transmitter	
2	INPUT Selector Buttons	SDI	Press to select the SDI input
3		Y/C	Press to select the s-Video input
4		CV 1	Press to select the composite video 1 input
5		CV 2	Press to select the composite video 2 input
6		PC	Press to select the computer graphics input
7		YPbPr	Press to select the component video input
8		HDMI	Press to select the HDMI input
9		DVI	Press to select the DVI input
10		TEST PATTERN Button	Press to toggle between a blank screen (blue or black screen) and the display
11	PIP Button	Press to toggle between muting (blocking out the sound) and enabling the audio output	
12	MENU Button	Displays the OSD menu (see Section 6)	
13	ENTER Button	Press to move to the next level in the OSD screen or to accept a new parameter	
14	Navigation Buttons:		
	◀ Button	Press to decrease numerical values or select from several definitions	
	▲ Button	Press to move up the menu list values (see Section 6)	
	▶ Button	Press to increase numerical values or select from several definitions	
	▼ Button	Press to move down the menu list (see Section 6)	
15	RESET TO XGA/720p Button	Press to reset the video resolution to XGA or 720p Press and hold for about 2 seconds to reset to XGA; or press and hold for about 5 seconds to reset to 720p	
16	PANEL LOCK Button	Press and hold (for about 2 seconds) to lock/unlock the front panel buttons	

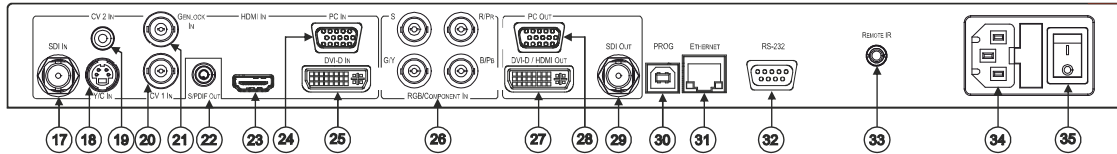

Figure 2: VP-790 Genlock Presentation Switcher/Scaler Rear Panel

#	Feature	Function					
17	SDI IN BNC Connector	Connect to the SDI source					
18	Y/C IN 4-pin Connector	Connect to the s-Video source					
19	CV 2 IN RCA Connector	Connect to the composite video 2 source					
20	CV 1 IN BNC Connector	Connect to the composite video 1 source					
21	GENLOCK IN BNC Connector	Connect to an external genlock input					
22	S/PDIF OUT RCA Connector	Connect to a digital audio acceptor					
23	HDMI Connector	Connect to the HDMI source					
24	PC IN 15-pin HD Connector	Connect to the computer graphics source					
25	DVI IN DVI-I Connector	Connect to the DVI source					
26	RGB/COMPONENT IN BNC Connectors	<table border="1"> <tr> <td>S</td> <td rowspan="4">Connect to the RGBS/component video source</td> </tr> <tr> <td>R/Pr</td> </tr> <tr> <td>G/Y</td> </tr> <tr> <td>B/Pb</td> </tr> </table>	S	Connect to the RGBS/component video source	R/Pr	G/Y	B/Pb
S	Connect to the RGBS/component video source						
R/Pr							
G/Y							
B/Pb							
27	DVI-D/HDMI OUT DVI Connector	Connect to the DVI/HDMI acceptor					
28	PC OUT 15-pin HD Connector	Connect to a VGA acceptor					
29	SDI OUT BNC Connector	Connect to an SDI acceptor					
30	PROG USB Connector	Connect to a PC for firmware upgrade					
31	ETHERNET Connector	Connects to the PC or other Serial Controller through computer networking					
32	RS-232 9-pin D-sub Port	Connect to the PC or the remote controller					
33	REMOTE IR Opening (Covered by a cap. The 3.5mm connector at the end of the internal IR connection cable fits through this opening)	Connects to an external IR receiver unit for controlling the machine via an IR remote controller instead of using the front panel IR receiver (see Section 3.1)					
34	Power Connector with Fuse	AC connector, enabling power supply to the unit					
35	POWER Switch	Illuminated switch for turning the unit ON or OFF					

4 Installing in a Rack

This section provides instructions for rack mounting the unit.

Before installing in a rack, be sure that the environment is within the recommended range:

OPERATING TEMPERATURE:	0° to +40°C (32° to 104°F)
STORAGE TEMPERATURE:	-40° to +70°C (-40° to 158°F)
HUMIDITY:	10% to 90%, RHL non-condensing



CAUTION!

When installing on a 19" rack, avoid hazards by taking care that:

1. It is located within the recommended environmental conditions, as the operating ambient temperature of a closed or multi unit rack assembly may exceed the room ambient temperature.
2. Once rack mounted, enough air will still flow around the machine.
3. The machine is placed straight in the correct horizontal position.
4. You do not overload the circuit(s). When connecting the machine to the supply circuit, overloading the circuits might have a detrimental effect on overcurrent protection and supply wiring. Refer to the appropriate nameplate ratings for information. For example, for fuse replacement, see the value printed on the product label.
5. The machine is earthed (grounded) in a reliable way and is connected only to an electricity socket with grounding. Pay particular attention to situations where electricity is supplied indirectly (when the power cord is not plugged directly into the socket in the wall), for example, when using an extension cable or a power strip, and that you use only the power cord that is supplied with the machine.

To rack-mount a machine:

1. Attach both ear brackets to the machine. To do so, remove the screws from each side of the machine (3 on each side), and replace those screws through the ear brackets.

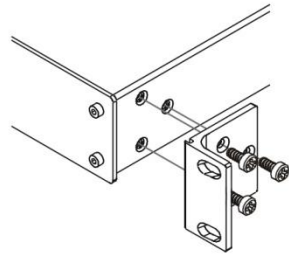

2. Place the ears of the machine against the rack rails, and insert the proper screws (not provided) through each of the four holes in the rack ears.

Note:

- In some models, the front panel may feature built-in rack ears
- Detachable rack ears can be removed for desktop use
- Always mount the machine in the rack before you attach any cables or connect the machine to the power
- If you are using a Kramer rack adapter kit (for a machine that is not 19"), see the Rack Adapters user manual for installation instructions available from our Web site

5 Connecting the VP-790



Always switch off the power to each device before connecting it to your **VP-790**. After connecting your **VP-790**, connect its power and then switch on the power to each device.



You do not have to connect all the inputs and outputs, connect only those that are required.

To connect the **VP-790**, as illustrated in the example in [Figure 3](#), do the following:

1. Connect an SDI source (for example, an SDI digital camera) to the SDI IN BNC connector.
2. Connect an s-Video source (for example, an s-Video player) to the Y/C IN 4-pin VIDEO INPUT connector.
3. Connect a component video source (for example, a component video player) to the COMP/RGB IN PR, PB and Y, RCA connectors.
4. Connect an HDMI source (for example, a DVD player) to the HDMI IN connector.
5. Connect a computer graphics source to the PC IN 15-pin HD VIDEO INPUT connector.
6. Connect a DVI source (for example, a computer) to the DVI-D IN DVI connector.
7. Connect a composite video source (for example, a composite video player) to the CV 1 IN BNC connector.
8. Connect a composite video source (for example, a composite video player) to the CV 2 IN RCA connector (not shown in [Figure 3](#)).
9. Connect an external sync source to the GENLOCK IN BNC connector (not shown in [Figure 3](#)).

10. Connect the SDI OUT BNC connector to an SDI acceptor (for example, a projector).
11. Connect the DVD-D/HDMI VIDEO OUT connector to an HDMI acceptor (for example, an LCD display).
12. Connect the PC OUT 15-pin HD connector to a VGA acceptor (for example, a display).
13. Connect the audio output signal to the S/PDIF OUT digital audio acceptor, as required (not shown in [Figure 3](#)).
14. Connect the power cord (not shown in [Figure 3](#)).

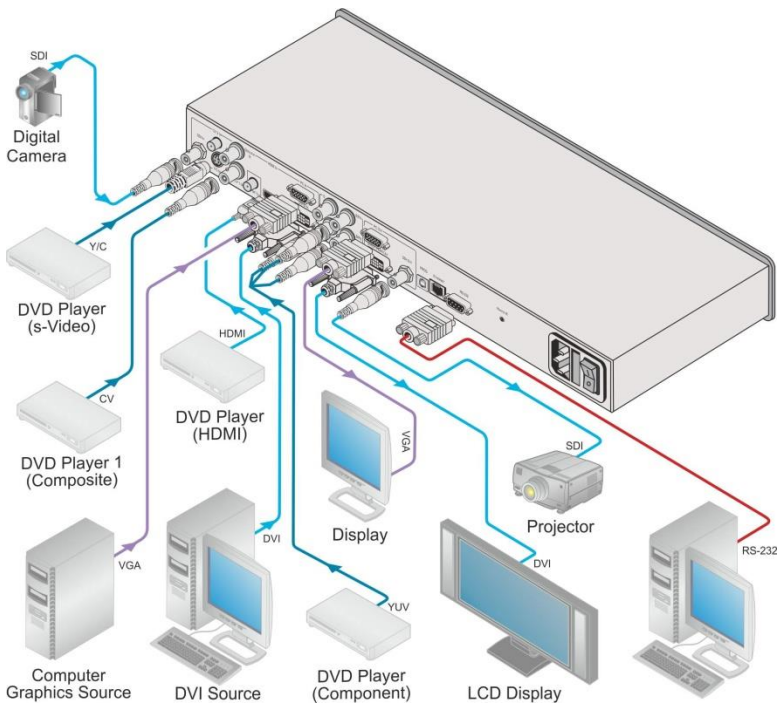

Figure 3: Connecting the VP-790 Genlock Presentation Switcher/Scaler

6 Configuring the VP-790 via the OSD MENU Screens

The **VP-790** uses an on-screen display (OSD) menu for system configuration. The menu appears as an overlay over any images that are output from the **VP-790**.

There are seven sub-menus (the PIP and Multiunit menus automatically replace each other in the Single Unit mode and the Multi-unit mode, respectively) that are used to configure the **VP-790**. You can activate and navigate these menus from the front panel buttons or from the IR remote control.

Single Unit Mode Menu Items:

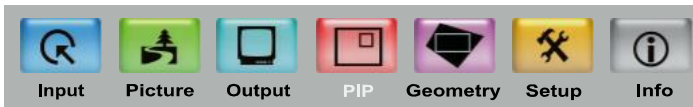

Multi-Unit Mode Menu Items:



Figure 4: MENU Items

To access and use the OSD menus, push the button for the desired input signal (alternatively, you can select the desired input via the Input OSD menu), then press the MENU front panel OSD button or the MENU key on the infrared remote control transmitter to display the main MENU screen which shows the seven interactive icons.

- Press the ◀ or ▶ buttons to select the desired sub-menu, and then press ENTER
- Press the ▲ or ▼ buttons to select the menu item to be adjusted, and then press ENTER
- Press the ▲ or ▼ buttons to make the adjustment and then press ENTER
- Press the ◀ or ▶ buttons to increase or decrease the (numerical) value as needed

To return to the previous menu level, press the front panel MENU button or the MENU key on the remote control. All settings and adjustments are automatically saved in non-volatile memory for each of the inputs (except USB).



The values defined in the different menus may change according to the firmware version (you can download the up-to-date firmware version from our Web site at http://www.kramerelectronics.com/support/product_downloads.asp).

6.1 The Input Screen

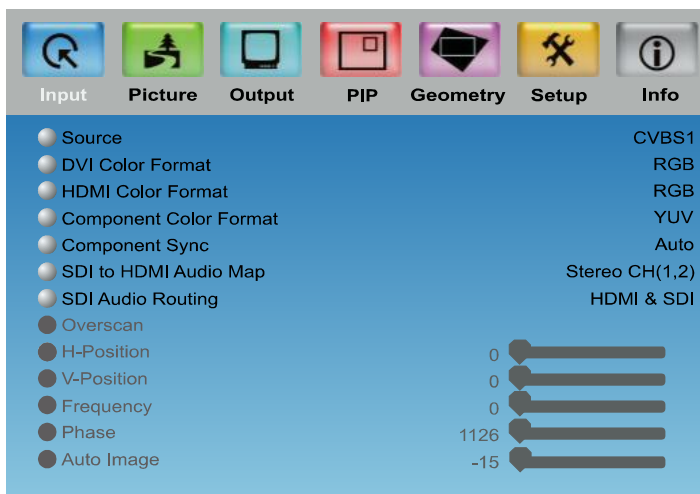

Figure 5: Input Screen

Setting	Function
Source	Select the source: CVBS 1, CVBS 2, S-VIDEO, COMPONENT, VGA, 3G-SDI, DVI, HDMI or Test Pattern When switching sources, the image fades through black When selecting the Test Pattern input, you can select one of the 11 built-in test patterns available (for example, gray bars, color bars and so on) The source is automatically updated when pressing an input front panel button on the machine
DVI Color Format	Select the DVI input color format: RGB, YUV or Auto
HDMI Color Format	Select the HDMI input color format: RGB, YUV or Auto
Component Color Format	Select the Component Video input color format: RGB, YUV or Auto

Setting	Function
Component Sync	<p>Select the component sync: 3 Wire, 4 Wire, Auto</p> <p>3 Wire: The sync signal is stripped from the green or Y channel (typical for YUV)</p> <p>4 Wire: The sync signal is derived from a separate sync line (typical for RGB)</p> <p>Auto: Automatically detects a sync signal</p> <p>The Auto setting will automatically detect a sync signal and set-up the VP-790 accordingly</p>
SDI to HDMI Audio Map	<p>Select the channels through which the SDI audio signal will be routed to the HDMI output: Stereo ch(1,2), Stereo ch(3,4), Stereo ch(5,6), Stereo ch(7,8) or multichannel</p> <p>The SDI audio input is routed to the HDMI and 3G-SDI output connectors by default. Two consecutive SDI audio channels can be output on the HDMI/3GSDI output interface. The group can be chosen. Or all eight SDI audio channels can be transmitted.</p>
SDI Audio Routing	Select HDMI & SDI or S/PDIF
H-Position	<p>Set the horizontal position according to the input resolution</p> <p>For UXGA and component video inputs</p>
V-Position	Set the vertical position according to the input resolution
Frequency	<p>Adjust the frequency</p> <p>For UXGA inputs</p>
Phase	Adjust the phase: 0 to 31
Auto image	Assesses the image and improves the quality accordingly, by automatically adjusting the phase, frequency and position

6.2 The Picture Screen

The Brightness, Contrast, Color, Hue and sharpness settings are saved individually for each input (except USB).

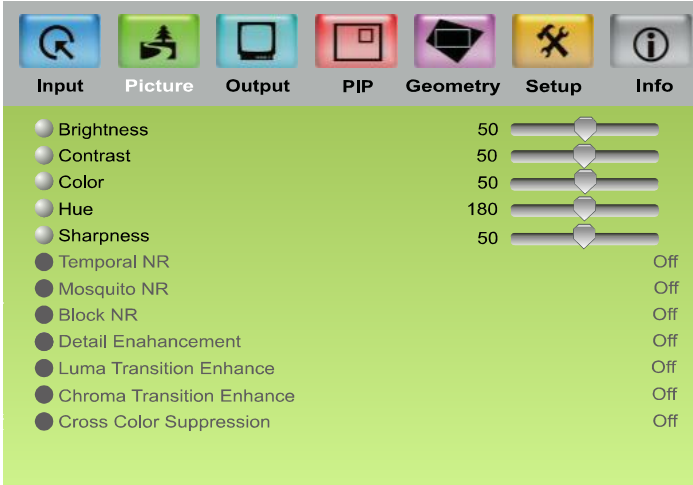

Figure 6: Picture Screen

Setting	Function
Brightness	Adjust the brightness
Contrast	Adjust the contrast
Color	Adjust the color
Hue	Adjust the hue
Sharpness	Adjust the sharpness
Temporal NR	Set the temporal noise reduction level: Off, Low, Medium, High
Mosquito NR	Set the Mosquito noise reduction level: Off, Low, Medium, High
Block NR	Set the block noise reduction level: Off, On
Detail Enhancement	Set the detail enhancement: Off, Low, Medium, High If the USB input is selected, Detail Enhancement is set to Off
Luma Transition Enhance	Set the luminance transition enhance level: Off, Low, High
Chroma Transition Enhance	Set the chrominance transition enhance level: Off, Low, High
Cross Color Suppression	Select On to reduce luminance to chrominance crosstalk which appears as a coarse rainbow pattern or random colors in regions of fine details For composite video signals only (CVBS1 or CVBS2).

6.3 The Output Screen

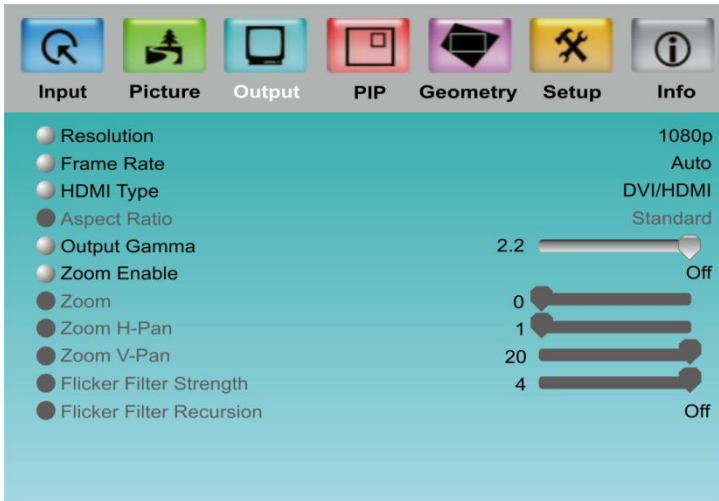

Figure 7: Output Screen

Setting	Function
Resolution	<p>Set the resolution: 640x480, 800x600, 1024x768, 1280x768, 1280x800, 1280x1024, 1360x768, 1366x768, 1400x1050, 1440x900, 1600x1200, 1680x1050, 1920x1200, 480i, 480p, 576p, 720p, 1080i, 1080p</p> <p>Note that any change in the resolution must be confirmed via the count-down message that appears on the screen</p> <p>The 3G-SDI output supports 480i, 480p, 576i, 576p, 720p, 1080i and 1080p resolutions only</p>
Frame Rate	<p>Select 60Hz, 50Hz or Auto</p> <p>When Auto is selected, the output frame rate follows the input frame rate as configured in the Output Config menu</p>
HDMI Type	<p>Set the HDMI type: DVI/HDMI, Native, DVI Forced</p> <p>DVI/HDMI: the output is set to the capability of the attached monitor and is determined by the information provided through DDC and EDID by the monitor</p> <p>Native: the output resolution is automatically set to the native screen resolution of the connected display</p> <p>DVI Forced: outputs with 24 bit color depth irrespective of the supported standard of the display</p>

Setting	Function
Aspect Ratio	<p>Set the aspect ratio to: Standard, Full Screen, Crop or Anamorphic (also see Section 6.3.1):</p> <p>Standard: Maintains the aspect ratio of the input and scales the image to fit the display size. The background remains black</p> <p>Full Screen: Fits the image to the size of the display without maintaining the aspect ratio</p> <p>Crop: Maintains the aspect ratio of the input and crops the image so it fits the display</p> <p>Anamorphic: scales the input image to 16:9 and fits the 16:9 scaled image to the display</p> <p>Note that some aspect ratios may not be applicable to all signal types, in which case selecting a non-applicable aspect ratio conversion will have no effect on the displayed image. For example, when a 16:9 image is displayed on a 16:9 panel all settings give an identical full screen image</p>
Output Gamma	<p>Set the output gamma: 1.0 to 2.2</p> <p>Output gamma allows to re-gamma video signals with pre-configured gamma values to match the display.</p> <p>If, for example, an adjustment to reduce the level of red in the image is required, select a higher number for the (input) Color Temp in the Color menu, or a lower number for the Native Color Temp in the Output menu</p>
Zoom Enable	Off or On
Zoom	Set the Zoom
Zoom H-Pan	Set the Zoom H-Pan
Zoom V-Pan	Set the Zoom V-Pan
Flicker Filter Strength	Set to control the filter weighting of prior field versus current field
Flicker Filter Recursion	Recursion chooses between vertical filtering of current and prior input fields, or current field and recursive data output from filter during prior field

6.3.1 The Flicker Filter

The Flicker Filter reduces interlace horizontal line edge bounce or flicker when scan converting from a computer progressive input format to an interlaced output signal. By choosing the filter strength and recursion mode it is possible to choose between higher levels of flicker reduction or better motion reproduction.



Flicker filter is available in the PIP/Single unit mode but not in the multiple unit mode.

The flicker filter applies to the DVI and HDMI computer input ports. It does not apply to the composite, s-Video, component and 3G-SDI video inputs or to interlaced modes on DVI and HDMI. The filter strength slider is always available and the strength can be changed but it has no effect to a currently displayed interlace mode or video input port.

The Flicker Filter reduces interlace horizontal line edge bounce or flicker when scan converting from a computer progressive input format to an interlaced output signal. By choosing the filter strength and recursion mode it is possible to choose between higher levels of flicker reduction or better motion reproduction.

6.3.2 Selecting the Correct Aspect Ratio

You can configure the aspect ratio of any output image to fit your application. The **VP-790** offers six different aspect ratio settings: Best Fit, Letterbox, Follow Output, Virtual Wide, Follow Input, and Custom. Here is how each of these settings works.

STANDARD – This setting re-sizes the video or graphics input signal to best fit the output resolution while maintaining the aspect ratio of the input signal. For example, a composite video signal (4:3 aspect ratio) will "best fit" to the top and bottom of a widescreen output image, resulting in black areas on either side or top and bottom edges.



FULL SCREEN – The aspect ratio and resolution of the input signal is re-sized to precisely fit the size of the display. This may result in some distortion to the input signal images



CROP – The aspect ratio and resolution of the input video or graphics signal are both preserved.



ANAMORPHIC – scales the input image so that it is displayed with a 16:9 aspect ratio when on the screen.



6.4 The PIP Screen

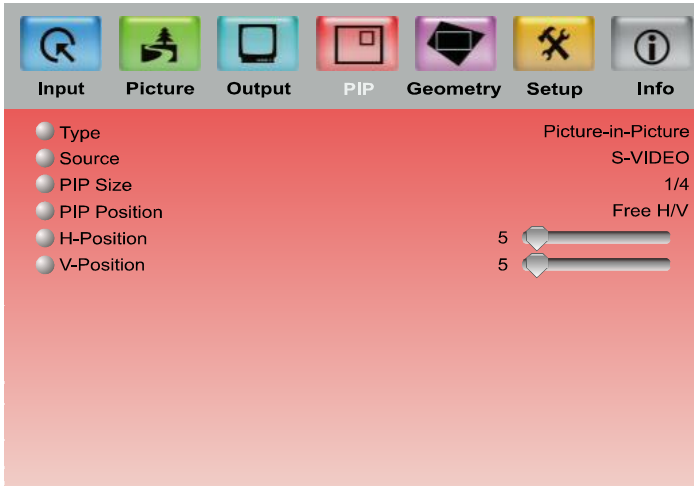

Figure 8: PIP Screen

Setting	Function
Type	Select the PIP type: Picture-in-Picture, Split, Picture + Picture or Off Picture in Picture: Displays a second input channel over the main one Split: displays two inputs side by side scaled to the size of the display Picture + Picture: Displays two inputs side by side while maintaining the aspect ratio of each input
Source	Select the PIP source: CVBS1, CVBS2, S-VIDEO, COMPONENT, VGA, 3G-SDI, DVI or HDMI If the main input channel is HDMI, DVI, DVI-A, VGA or COMPONENT, the PIP source can be selected from CVBS1, CVBS2, S-VIDEO or HD-SDI If the main input channel is CVBS1, CVBS2, S-VIDEO or HD-SDI, the PIP source can be selected from HDMI, DVI, DVI-A, VGA or COMPONENT
PIP Size	Select the PIP size: 1/16, 1/9, 1/4, or Custom
PIP Position	Set the position of the PIP on the display: Free H/V, Top Left, Top Right, Bottom Left, Bottom Right
H-Position	Set the horizontal position of the PIP on the display Is available only if Free H/V is selected for PIP Position
V-Position	Set the vertical position of the PIP on the displays available only if Free H/V is selected for PIP Position

6.4.1 The PIP Feature

The **VP-790** PIP feature lets you show two images on one screen: the main window and the PIP window.

If the main input channel is HDMI, DVI, DVI-A, VGA or COMPONENT, the PIP source can be selected from CVBS1, CVBS2, S-VIDEO or HD-SDI. If the main input channel is CVBS1, CVBS2, S-VIDEO or HD-SDI, the PIP source can be selected from HDMI, DVI, DVI-A, VGA or COMPONENT.

For example, you can show a live video window on top of a graphic background, or a graphic picture side by side with a video window.

The PIP window mode appears in the following preset PiP configurations:

Picture-in-Picture, with a smaller PiP window superimposed over a full main window image



Picture + Picture, where both images appear side-by-side and the aspect ratios of both images are maintained



The PIP window size feature lets you select one of three preset sizes or customize the PIP window to any size.

If the HDMI signal is HDCP protected, it can appear on HDMI and digital outputs that support HDCP compliant displays. However, it cannot appear on a display that is not HDCP compliant and the **VP-790** will not output a picture on the VGA and SDI outputs.

6.4.1.1 Activating the PIP

You can the PIP feature (indicated by an illuminated PIP front panel button) in any of the following ways:

- Press and hold (for about 2 seconds) the front panel PIP button
- Press the PIP button on the IR remote control transmitter (see [Section 7.4](#))
- Access the OSD menu, select SETUP>Operation Mode>PIP/Single Mode and then in the PIP menu select the PIP type
- Via the Web pages (see [Section 7.3.3](#))

6.4.1.2 Selecting the PIP Source

To select a PiP source you have to set the **VP-790** to any of the PiP display mode configurations. From the PIP menu, select the PIP source.

6.5 The Multi-unit Screen

Multiple screens can be set in a matrix to provide a larger display that provides a resolution that is higher than that of a single display. Each display is controlled by one **VP-790** unit. Each **VP-790** unit gets the same graphics or video input signal via a distribution amplifier and outputs the part of the image to its corresponding display (defined in the Multi-unit OSD screen). In the matrix display the individual projections usually overlap to give a uniform intersection. The overlapping regions are illuminated by multiple projectors and are brighter than non-overlapping regions. For a uniform brightness over the total display, the brightness in the overlapping regions has to be reduced electronically.



PIP functionality is not supported in the Multi-unit operation mode due to the higher bandwidth requirements of the video processing.



When using multiple **VP-790** units to drive a matrix display, it is essential that all **VP-790** units are frame locked, otherwise motion tear will be observed at the boundaries of the image processed by each **VP-790**. The processing mode should be identical for all the units as well (see [Section 6.7](#)).

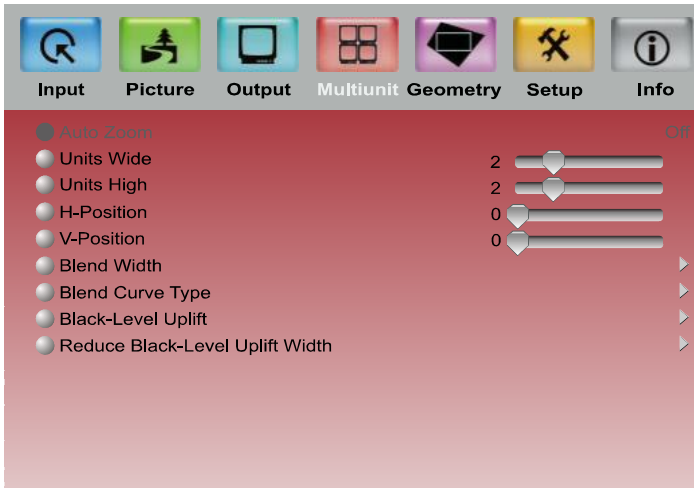



Figure 9: Audio Screen

Setting	Function
Auto Zoom	Select to automatically crop and zoom the input video image so it outputs the appropriate part in the matrix
Units Wide	Set the number of screens comprising the width of the wall display matrix (1 to 4)
Units High	Set the number of screens comprising the height of the wall display matrix (1 to 4)
H-Position	Define the horizontal position of the display in the matrix The unit will cut and resize the output signal according to the display's location in the matrix
V-Position	Define the vertical position of the display in the matrix The unit will cut and resize the output signal according to the display's location in the matrix
Blend Width	<p>Set the overlap region for the left, right, top and bottom blend regions In the overlap region, the image intensity gradually fades towards the edge of the blend area (the fading curve can be controlled via the S-Curve item below)</p> <p>The blend width is set in output pixels with a range of up to a quarter of the output resolution. For a configuration with two projectors, for example, in the horizontal direction, the overlap can be higher to allow 16:9 images to fit on two combined projectors with an aspect ratio of 4:3 or 5:4</p> <p>Set the blend width offset for the left, right, top and bottom blend regions The area between the edge and the start of the blend area is black. The total number of pixels of the blend area and the offset region is limited by the same amount of pixels as for an offset of zero</p>

Setting	Function
Blend Width (Contd.)	 Each display in the matrix needs to be set to the same blend width and offset value for its left and right sides. The top and bottom blend width and offset values also need to be identical (though they don't have to be identical to the left and right settings). This is necessary for the calculating the Auto Zoom for the matrix.
Blend Curve Type	Select the blend curve type to Off, S-Curve or Align Pattern Off: the blend area is displayed without applying any gain factor (align pattern or S-curve) Align Pattern: Reduce the image intensity of each pixel in the blend area by 50% S-Curve: Select S-Curve when the blend region (defined in the Blend Width menu item above) and the physical blend match. The S-Curve reduces the image intensity along the blend width. Use the S-Curve Value slider to control the image intensity change rate along the blend area. Use the Output Gamma slider to set the output gamma to match the gray scale of the images
Black Level Uplift	Set the uplift black level: Non Blend Region, Top Left, Top Middle, Top Right, Middle Left, Middle Right, Bottom Left, Bottom Middle and Bottom Right Setting the black levels for the display edges compensate for additional light leakage from multiple projectors in the overlapping areas. The adjustable areas are available according to the position of the display in the matrix. Setting the middle regions automatically sets the adjacent left and right regions, but you can still set the left and right separately.
Reduce Black Level Uplift Width	Adjust the black level uplift width in case the projection is performed under non-rectangular conditions. The black level uplift may be used for bright projectors in dark environments. The Black Level Uplift field may need to be adjusted to achieve a perfect result. There may be an area of light leakage beyond the edge of the active image from the projector. With these controls the edges of the black uplift region can be moved so they can be aligned with the edges of the area of light leakage. In the case of projection under non-rectangular conditions the projection fields of adjacent projectors are not aligned with the blend region. The corners of the non-blend region can be moved to allow tracking of the edge of the projection field of adjacent projectors

6.6 The Geometry Screen

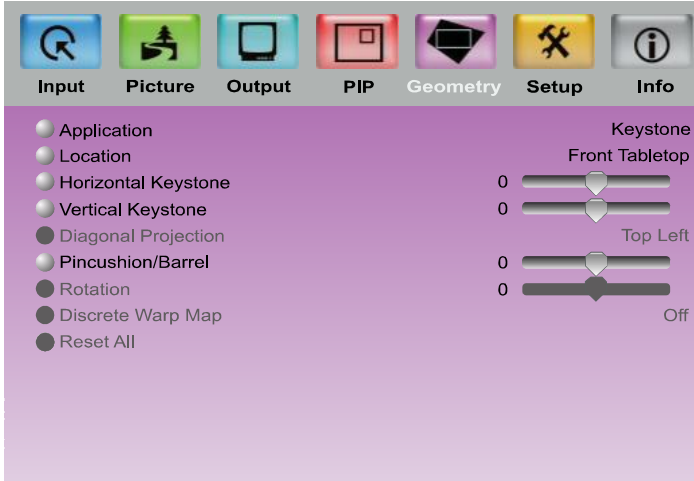

Figure 10: Geometry Screen

Setting	Function	Default
Application	Select the output application: Off, Keystone, Anyplace, Rotation or PC	
Location	Select the location of the display: Front Tabletop, Front Ceiling, Rear Tabletop or Rear ceiling	
Horizontal Keystone	Adjust the horizontal keystone If the projector is located at an angle to the left or right of the screen	
Vertical Keystone	Adjust the vertical keystone. If the projector is located at an angle above or below the screen	
Diagonal Projection	Move the location of each corner of the display separately (horizontal and vertical): Top Left, Top Right, Bottom Left, Bottom Right or Reset All (to reset diagonal projections settings) When selecting a corner, for example the Top Left corner, the following message appears: Use the ▷◀△▽ keys to drag the top left corner of the screen. Hit Enter to go back	
Pincushion/Barrel	Adjust the pincushion or barrel appearance of the screen: -20 to 20	
Rotation	Rotate the display by 180 degrees clockwise or counterclockwise: -180 to 180	
Discrete Warp Map	Set to a preset warp configuration: Off, 1 to 8 Warp maps created with the "Warp Generator" PC application can be uploaded into VP-790 and processed accordingly	
Reset All	Resets to default view	

The settings available for each application are defined in the following table:

Application	Available Settings
Keystone	Location, Horizontal Keystone, Vertical Keystone, Pincushion/Barrel and Reset All
Anypace	Location, Diagonal Projection and Reset All
Rotation	Location, Pincushion/Barrel, Rotation and Reset All
PC	Location, Discrete Warp Map and Reset All

6.7 The Setup Screen

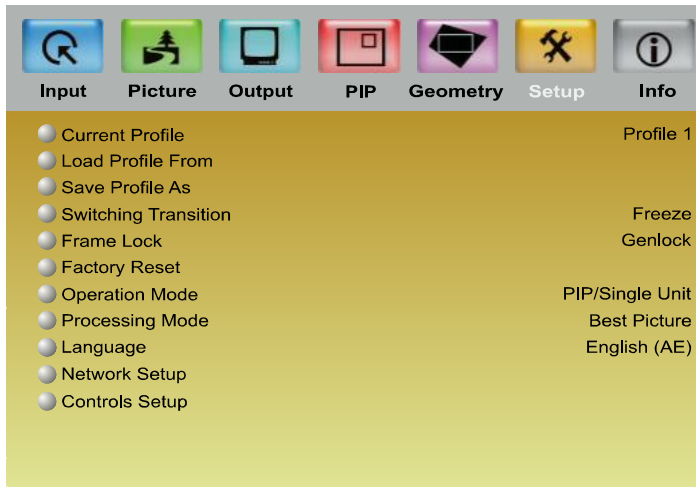



Figure 11: Setup Screen

Setting	Function
Current Profile	Select one of up to four profiles from 1 to 4 The profile includes settings such as the output resolution, filter and color settings, warp maps, and so on
Load Profile From	Recalls a profile from 1 to 4
Save Profile As	Save up to four profiles 1 to 4
Switching Transition	Set the switching transition mode: Freeze, Blank, Fast Fade or Slow Fade

Setting	Function
Frame Lock	<p>Set the frame lock mode: Off, Source, Genlock or Auto</p> <p>Off: the output is set to a fixed refresh rate defined by the frame rate setting (in the Output menu, Section 6.3), which deviates from the input refresh rate, even if both are nominally at the same rate. This causes occasional frame dropping or repeat</p> <p>Source: the output refresh rate follows the input refresh rate if locking is possible</p> <p>Genlock: the output refresh rate follows the vertical sync of an external signal via the GENLOCK BNC connector, if locking is possible</p> <p>Auto: Default setup</p> <p>Locking is achieved by modulating the output clock and works if input and output refresh rate are nominally at the same rate, e.g. when frame rate is set to 60Hz and the video input is also 60Hz. If e.g. the video input rate is 50 Hz and the Frame rate is set to 60Hz, the output will enter free run mode. When Frame Rate is set to Auto, the matching frame rate is chosen.</p> <p>When I/O lock is set to Auto and a Genlock source is present to the GENLOCK BNC. If genlocking is not achievable, locking to the video source frame rate is tried. If that is not possible the output is running in free-run mode.</p> <p> When operating in the Multi-unit mode, the same frame lock should be defined in all the units in the matrix.</p>
Factory Reset	Select Yes to reset your VP-790 to its preset default settings
Operation Mode	<p>Set the Operation Mode: PIP/Single or Multiunit</p> <p>When selecting Multiunit, the Multiunit menu (see Section 6.5) replaces the PIP Menu (see Section 6.4)</p>
Processing Mode	<p>Set the processing mode: Gaming Mode, Medium Latency or Best Picture</p> <p>Gaming Mode: provides lower quality processing but a speedy response</p> <p>For applications that require a quick response such as simulations, medical imaging or gaming applications</p> <p>Medium Latency: provides medium quality picture processing</p> <p>Best Picture: provides optimum picture processing resulting in a high quality image</p> <p> When operating in the Multi-unit mode, the same processing mode should be defined in all the units in the matrix.</p>
Language	Select the language: English (AE), English (BE) or Deutsch (German)
Network Setup	<p>Network settings configuration:</p> <p>IP Address Type: Static or DHCP</p> <p>IP Address: 192.168.001.039</p> <p>Net Mask: 255.255.000.000</p>
Controls Setup	<p>Controls configuration:</p> <p>Menu Position: Center, top Left, Top Right, Bottom Left or Bottom right</p> <p>Menu Timeout: 5 sec, 10 sec, 15 sec, 20 sec, 25 sec, 30 sec or Infinite</p> <p>Input Lock: On or Off</p> <p>Set to OFF so you can still use the SOURCE buttons on the front panel even when the lock button is on</p> <p>Save Lock: On or Off</p> <p>Set to ON to save the lock status when the machine is powered down</p>

6.8 The Info Screen

From the Information screen (see [Figure 12](#)) you can verify the input resolution, the output resolution, the SYNC mode, as well as the firmware revision, DHCP status and IP address:

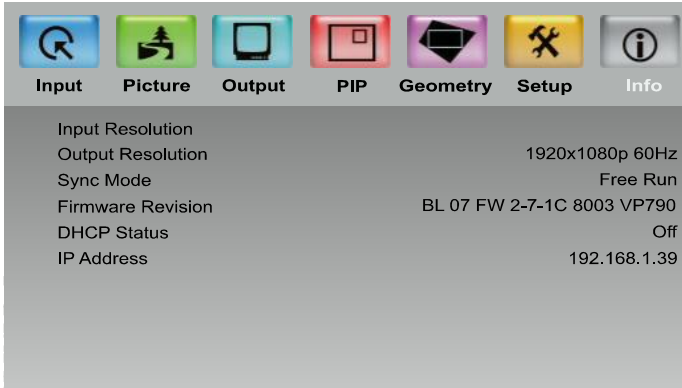

Figure 12: Information Screen

7 Controlling the VP-790

The **VP-790** can be controlled via:

- The front panel buttons (see [Section 7.1](#))
- RS-232 serial commands transmitted by a touch screen system, PC, or other serial controller (see [Section 7.2](#))
- The ETHERNET (see [Section 7.3](#))
- The infrared remote control transmitter (see [Section 7.4](#))

7.1 Controlling via the Front Panel Buttons

The **VP-790** includes the following front panel buttons:

- Input selector buttons for selecting the required input: SDI, s-Video (YC), CV (1 and 2), COMPONENT (YPbPr), PC, HDMI, or DVD-D
- The PIP button
- MENU, ENTER, and arrow buttons (up, down, left and right)
- RESET TO XGA/720p and PANEL LOCK buttons

7.2 Connecting to the Product via RS-232

You can connect to the **VP-790** via an RS-232 connection using, for example, a PC. Note that a null-modem adapter/connection is not required.

To connect to the **VP-790** via RS-232, connect the RS-232 9-pin D-sub rear panel port on the **VP-790** unit via a 9-wire straight cable (only pin 2 to pin 2, pin 3 to pin 3, and pin 5 to pin 5 need to be connected) to the RS-232 9-pin D-sub port on your PC.

7.3 Operating via Ethernet

You can connect to the **VP-790** via Ethernet using either of the following methods:

- Directly to the PC using a crossover cable (see [Section 7.3.1](#))
- Via a network hub, switch, or router, using a straight-through cable (see [Section 7.3.2](#))

Note: If you want to connect via a router and your IT system is based on IPv6, speak to your IT department for specific installation instructions.

7.3.1 Connecting the Ethernet Port Directly to a PC

You can connect the Ethernet port of the **VP-790** directly to the Ethernet port on your PC using a crossover cable with RJ-45 connectors.



This type of connection is recommended for identifying the **VP-790** with the factory configured default IP address.

After connecting the **VP-790** to the Ethernet port, configure your PC as follows:

1. Click **Start > Control Panel > Network and Sharing Center**.
2. Click **Change Adapter Settings**.
3. Highlight the network adapter you want to use to connect to the device and click **Change settings of this connection**.

The Local Area Connection Properties window for the selected network adapter appears as shown in [Figure 13](#).

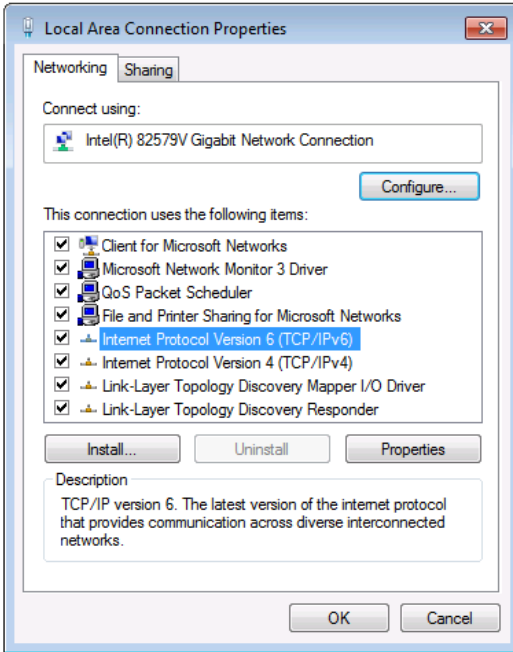

Figure 13: Local Area Connection Properties Window

4. Highlight either **Internet Protocol Version 6 (TCP/IPv6)** or **Internet Protocol Version 4 (TCP/IPv4)** depending on the requirements of your IT system.
5. Click **Properties**.
The Internet Protocol Properties window relevant to your IT system appears as shown in [Figure 14](#) or [Figure 15](#).

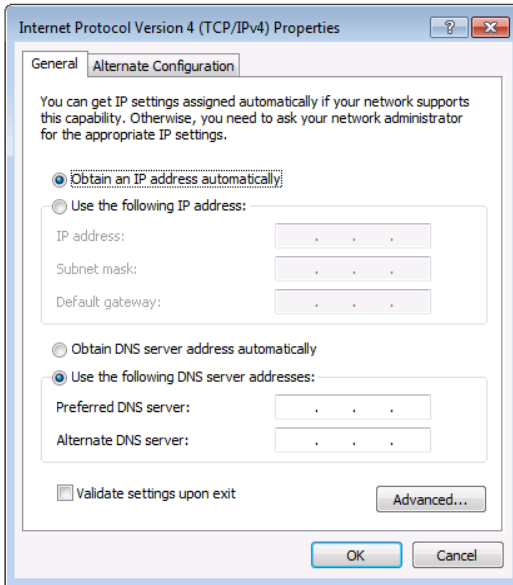

Figure 14: Internet Protocol Version 4 Properties Window

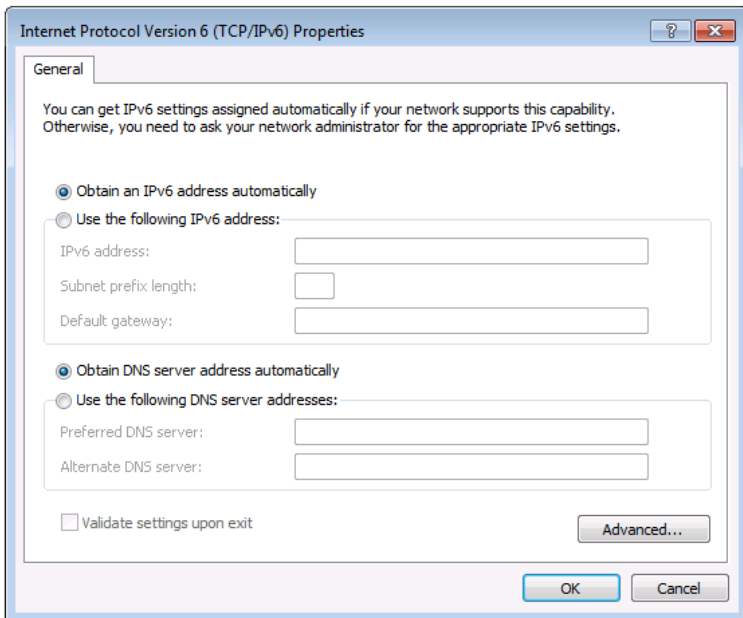

Figure 15: Internet Protocol Version 6 Properties Window

6. Select **Use the following IP Address** for static IP addressing and fill in the details as shown in [Figure 16](#).

For TCP/IPv4 you can use any IP address in the range 192.168.1.1 to 192.168.1.255 (excluding 192.168.1.39) that is provided by your IT department.

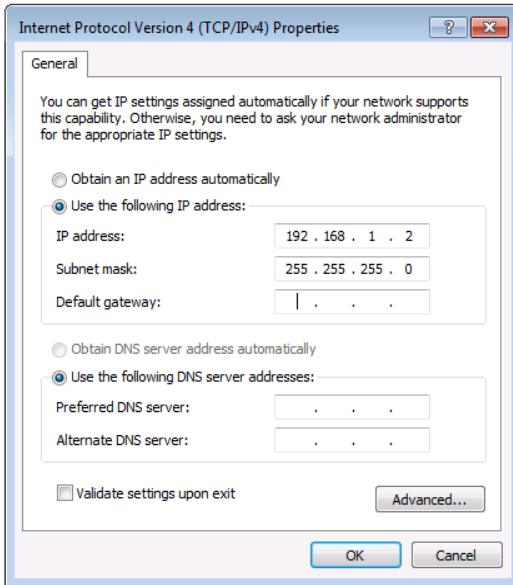

Figure 16: Internet Protocol Properties Window

7. Click **OK**.
8. Click **Close**.

7.3.2 Connecting the ETHERNET Port via a Network Hub (Straight-Through Cable)

You can connect the Ethernet port of the **VP-790** to the Ethernet port on a network hub or network router, via a straight-through cable with RJ-45 connectors.

7.3.3 Operating Remotely via the Web Pages

To access the **VP-790** Web pages:

1. Open your Internet browser.
2. Enter the IP address of the device (in the address bar of your browser (see [Figure 17](#)).

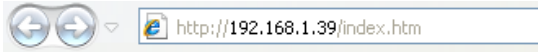

Figure 17: Web Browser Address Bar

The main menu appears:

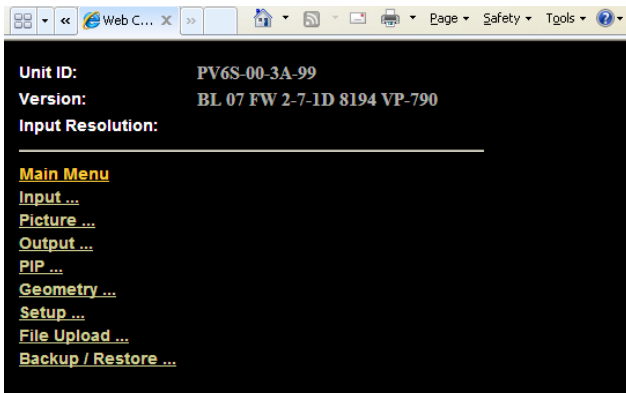

Figure 18: Web Browser Address Bar

The main menu lets you access the different menu items. The menu items are similar to the OSD menu (see [Section 6](#))

The Menu	Description
Input (see Section 6.1)	Select the: Source, DVI Color Format, HDMI Color Format, HDMI Color Format, Component Setup, Test Pattern, SDI to HDMI Audio Map and SDI Audio Routing; Set the: Overscan, H-Position, V-Position, Frequency, Phase and perform Auto Image
Picture (see Section 6.2)	Set the: Brightness, Contrast, Color, Hue and Sharpness Select the: Temporal NR, Mosquito NR, Block NR, Detail Enhancement, Luma Transition Enhance, Chroma Transition Enhance, Cross Color Suppression

The Menu	Description
Output (see Section 6.3)	Select the: Resolution, Frame Rate, Allowed Frame Rates, HDMI Type, Aspect Ratio, Zoom Enable and Flicker Filter Recursion Set the: Output Gamma, Zoom, Zoom H-Pan, Zoom V-Pan and Flicker Filter Strength
PIP (see Section 6.4)	Select the: Type, Source, PIP Size and PIP Position Set the: H-Position and V-Position
Multi-unit (see Section 6.5)	Select the Auto Zoom Set the unit width, unit height, H-Position and V-Position Access the Blendwidth, Blend Curve Type and Black-Level Uplift submenus
Geometry (see Section 6.6)	Select the: Application, Location and Discrete Warp Map Set the Horizontal Keystone, Vertical Keystone, Pincushion/Barrel distortion and Rotation Access the Diagonal Projection submenu Reset to default values
Setup (see Section 6.7)	Set the: Current Profile, Load Profile, Save Profile, Switching Transition, Frame Lock, Operation Mode, Processing Mode or Language Access the Network Setup and Controls Setup submenus Perform Factory Reset
File Upload	Lets you upload up to 5 custom test patterns
Backup / Restore	Lets you back up settings to a file and restore settings from a file
The File Upload and Backup/Restore menus appear only on the Web pages	

7.4 Controlling via the Infrared Remote Control Transmitter

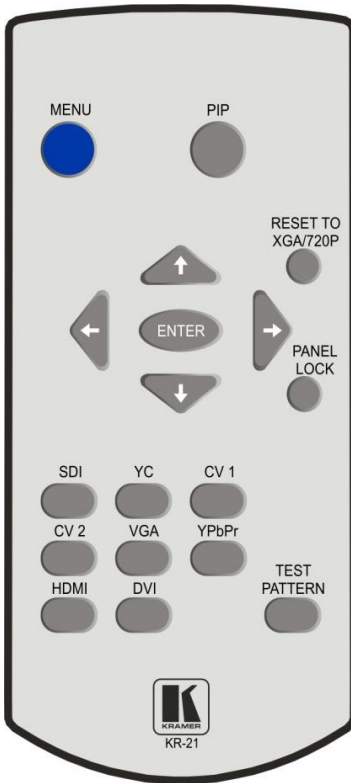
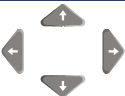



Figure 19: Infrared Remote Control Transmitter

Keys	Function
MENU	Enter the OSD menu. Press again to exit the menu
PIP	Toggle the PIP on or off
RESET TO XGA/720P	Press and hold to reset to the default resolution (toggles between RESET TO XGA and 720p)
	Four navigation keys
	Press to accept changes
PANEL LOCK	Lock the front panel lock
SDI	Select the SDI input
YC	Select the S-VIDEO input
CV1	Select the composite video 1 input
CV2	Select the composite video 2 input
VGA	Select the computer graphics input
YPbPr	Select the component video input
HDMI	Select the HDMI input
DVI	Select the DVI input
TEST PATTERN	Select the test pattern inputs. Cycles between different patterns with each press of the button

8 Firmware Upgrade

You can upgrade the **VP-790** via the Kramer **VP-790** Updater Tool software.



The latest version of firmware can be downloaded from the Kramer Web site at http://www.kramerelectronics.com/support/product_downloads.asp.

8.1 Installing the **VP-790** Updater Tool

Download the **VP-790** Updater Tool software from http://www.kramerelectronics.com/support/product_downloads.asp.

The **VP-790** Updater Tool requires the following:

- Windows™ XP, Vista or Windows™ 7
- Microsoft .Net Framework version 3.5

To install the **VP-790** Updater Tool:

1. Double click the Windows Installer Package file.

The **Welcome** window appears:

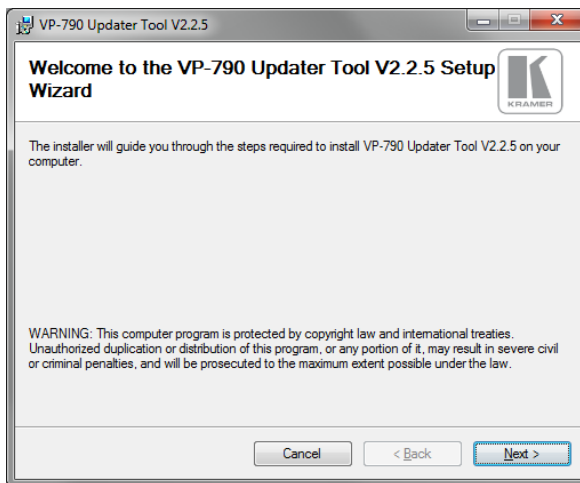

Figure 20: Welcome Window

2. Click **Next**.

The **Select Installation Folder** window appears:

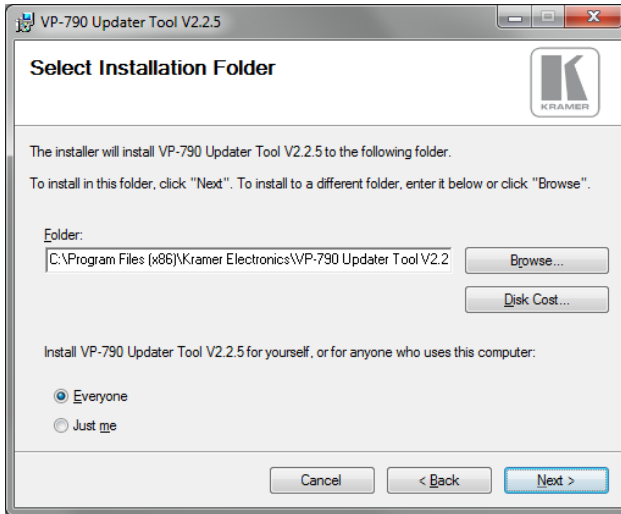

Figure 21: Choose Destination Location Window

3. Click **Browse** to select the destination folder.
4. When finished, click **Next**.

The **Confirm Installation** window appears:

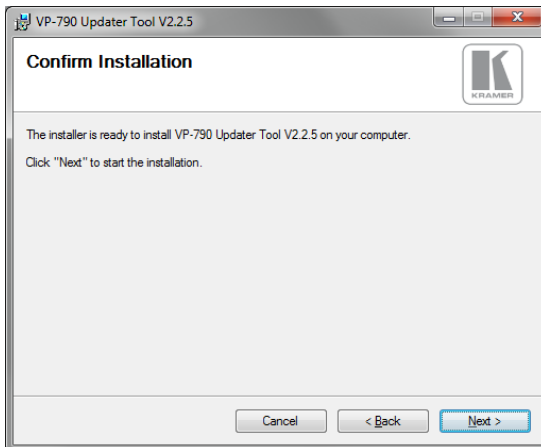

Figure 22: Confirm Installation

5. Click **Next**. The **Installation Progress** window appears:

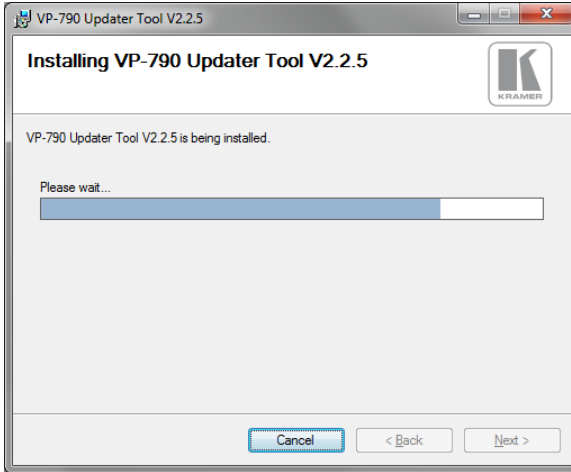

Figure 23: Installation Progress Window

Then the **Installation Complete** window appears:

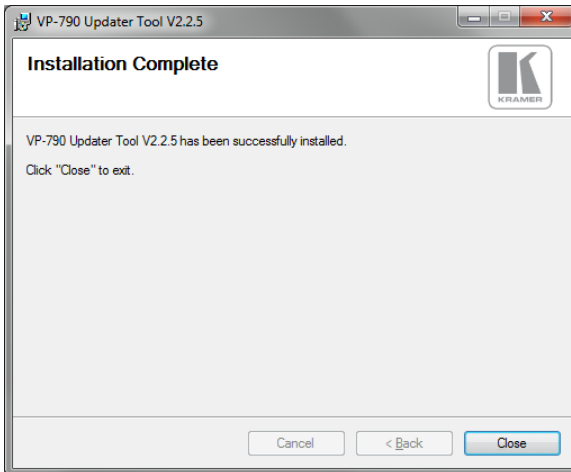

Figure 24: Installation Complete Window

6. Click **Close**.

An icon appears on the desktop and a shortcut appears in the **Start Menu Programs** folder in the **Kramer** sub-folder.

8.2 Saving User Settings

If you want to backup the user settings before upgrading the machine, you can do it through the **VP-790** Web pages. To do so, type the local IP address for the **VP-790** in the Web browser's address bar and press the ENTER button.

You can obtain/set the IP address via the OSD menu by entering the Network Setup submenu within the Setup Menu or by connecting the **VP-790** to an Ethernet based network with the default DHCP setting to allow the **VP-790** to obtain a valid IP address from the network server.

Following firmware upgrade you may find that the **VP-790** user settings have been reset to their factory default values. If you wish to restore the user settings, you can do it via the **VP-790** Web pages.

8.3 Updating the Firmware

To upgrade the firmware:

1. Power down the **VP-790**.
2. Press and hold the menu button and turn the power On again. After a few seconds, you can release the MENU button.
The **VP-790** enters the firmware update mode.
3. Start the **VP-790** Updater Tool application.

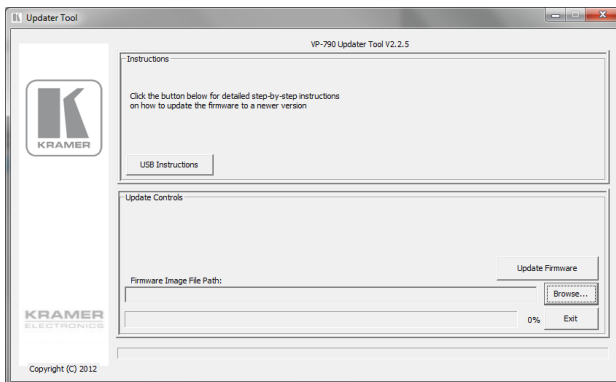

Figure 25: Updater Tool Window

4. Plug in a USB cable between the **VP-790** and the PC.
5. Using the **VP-790** Updater Tool application, click **Browse** and select the location of the desired BREC file to be programmed into the Unit.
6. Click **Update Firmware**.
When the **VP-790** has finished programming you will see a "Firmware update complete", dialog box (this will take a minute or two).
7. After firmware update is complete, click **OK**.
8. Unplug the USB cable from the **VP-790** unit.
9. Exit the **VP-790** Updater application.
Do this only after disconnection,
10. Power cycle the **VP-790** for the firmware update to take effect.
11. If you wish to restore the user settings go to [Section 8.2](#)

9 Technical Specifications

INPUTS:	1 3G-HD-SDI on a BNC connector 1 HDMI connector (HDCP version 1.1) 1 VGA on a 15-pin HD connector 1 composite video on an RCA connector 1 composite video on a BNC connector 1 component video/RGBS on 3/4 RCA connectors 1 DVI on a DVD-I connector 1 s-Video on a 4-pin connector
OUTPUTS:	1 3G-HD-SDI on a BNC connector 1 DVI/HDMI on a DVI-D connector (HDCP version 1.1) 1 VGA on a 15-pin HD connector 1 S/PDIF on an RCA connector
OUTPUT RESOLUTIONS:	640x480, 800x600, 1024x768, 1280x768, 1280x800, 1280x1024, 1360x768, 1366x768, 1400x1050, 1440x900, 1600x1200, 1680x1050, 1920x1200, 480i, 480p, 576p, 720p, 1080i, 1080p
CONTROLS	Input selector buttons: reset to XGA/720p, panel lock. Menu functions: menu, enter, menu arrows. RS-232, Ethernet, IR
OPERATING TEMPERATURE:	0° to +40°C (32° to 104°F)
STORAGE TEMPERATURE:	-40° to +70°C (-40° to 158°F)
HUMIDITY:	10% to 90%, RHL non-condensing
POWER SOURCE:	100-240VAC, 50-60Hz; 35VA (500mA maximum)
DIMENSIONS:	19-inch (W), 7-inch (D) 1U (H) rack mountable
WEIGHT:	2.7kg (6lbs) approx.
ACCESSORIES:	Power cord, rack ears, IR remote control transmitter
Specifications are subject to change without notice at http://www.kramerelectronics.com/	

9.1 Input Resolutions

This section defines the input resolutions for each input.

9.1.1 HDMI Input Resolutions

HDMI Input Resolutions (Video)				
480i	576p (ED)	1080i @59.94	1080p @25	1080p @59.94
576i	720p	1080i @60	1080p @30	1080p @60
480p	1080i @50	1080p @24	1080p @50	

HDMI Input Resolutions (Computer):

DOS, VGA to WUXGA up to 165 MHz pixel clock.

9.1.2 PC Input Resolutions

From VGA to WUXGA.

9.1.3 SDI Input Resolutions

SMPTE 292M, SMPTE 259M-C and SMPTE 424M compliant, accepts 484i (480i), 576i, 720p, 1080i and 1080p single link formats at 270Mb, 1.485Gb or 2.97Gb rates.

9.1.1 YUV, RGB and RGBS Input Resolutions

YUV, RGB and RGBS Input Resolutions				
484i (480i)	576p (ED)	1080i @59.94	1080p @24	1080p @30
576i (SD)	720p	1080i @60	1080p @25	
480p	1080i @50	1080p @23.98	1080p @29.97	



Note that this input does not support computer SVGA signals. SVGA signals should be passed via the PC IN 15-pin HD connector. The PC input supports the separate H and V syncs.

9.1.2 CV and s-Video Input Resolutions

NTSC, PAL and SECAM.

9.2 Output Resolutions

This section defines the output resolutions.

9.2.1 HDMI Output Resolutions

Technical Specifications of the HDMI Output Signal			
640x480@60	1280x1024@50	1680x1050@60	1080p25
640x480@75	1280x1024@60	1920x1200@60	1080p29.97
800x600@50	1280x1024@75	480i60	1080p30
800x600@60	1360x768@60	480p60	1080p50
800x600@75	1366x768@50	576i50	1080p59.94
1024x768@50	1366x768@60	576p50	1080p60
1024x768@60	1400x1050@50	720p50	2K50
1024x768@75	1400x1050@60	720p59.94	2K60
1280x768@50	1600x900@60	720p60	
1280x768@60	1600x1200@50	1080p23.976	
1280x800@60	1600x1200@60	1080p24	

9.2.1 SDI Output Resolutions

SMPTE 292M, SMPTE 259M-C and SMPTE 424M compliant, accepts (484i) 480i, 576i, 720, 1080i and 1080p single link formats at 270Mb, 1.485Gb or 2.97Gb rates.

9.2.2 PC Output Resolutions

From VGA to WUXGA, up to 165 MHz pixel clock.

9.3 RS-232 Communication Protocol

You can download the **VP-790** RS-232 communication protocol online guide from the **VP-790** Web page.

LIMITED WARRANTY

The warranty obligations of Kramer Electronics for this product are limited to the terms set forth below:

What is Covered

This limited warranty covers defects in materials and workmanship in this product.

What is Not Covered

This limited warranty does not cover any damage, deterioration or malfunction resulting from any alteration, modification, improper or unreasonable use or maintenance, misuse, abuse, accident, neglect, exposure to excess moisture, fire, improper packing and shipping (such claims must be presented to the carrier), lightning, power surges, or other acts of nature. This limited warranty does not cover any damage, deterioration or malfunction resulting from the installation or removal of this product from any installation, any unauthorized tampering with this product, any repairs attempted by anyone unauthorized by Kramer Electronics to make such repairs, or any other cause which does not relate directly to a defect in materials and/or workmanship of this product. This limited warranty does not cover cartons, equipment enclosures, cables or accessories used in conjunction with this product.

Without limiting any other exclusion herein, Kramer Electronics does not warrant that the product covered hereby, including, without limitation, the technology and/or integrated circuit(s) included in the product, will not become obsolete or that such items are or will remain compatible with any other product or technology with which the product may be used.

How Long Does this Coverage Last

Seven years as of this printing; please check our Web site for the most current and accurate warranty information.

Who is Covered

Only the original purchaser of this product is covered under this limited warranty. This limited warranty is not transferable to subsequent purchasers or owners of this product.

What Kramer Electronics will do

Kramer Electronics will, at its sole option, provide one of the following three remedies to whatever extent it shall deem necessary to satisfy a proper claim under this limited warranty:

1. Elect to repair or facilitate the repair of any defective parts within a reasonable period of time, free of any charge for the necessary parts and labor to complete the repair and restore this product to its proper operating condition. Kramer Electronics will also pay the shipping costs necessary to return this product once the repair is complete.
2. Replace this product with a direct replacement or with a similar product deemed by Kramer Electronics to perform substantially the same function as the original product.
3. Issue a refund of the original purchase price less depreciation to be determined based on the age of the product at the time remedy is sought under this limited warranty.

What Kramer Electronics will not do Under This Limited Warranty

If this product is returned to Kramer Electronics or the authorized dealer from which it was purchased or any other party authorized to repair Kramer Electronics products, this product must be insured during shipment, with the insurance and shipping charges prepaid by you. If this product is returned uninsured, you assume all risks of loss or damage during shipment. Kramer Electronics will not be responsible for any costs related to the removal or re-installation of this product from or into any installation. Kramer Electronics will not be responsible for any costs related to any setting up this product, any adjustment of user controls or any programming required for a specific installation of this product.

How to Obtain a Remedy under this Limited Warranty

To obtain a remedy under this limited warranty, you must contact either the authorized Kramer Electronics reseller from whom you purchased this product or the Kramer Electronics office nearest you. For a list of authorized Kramer Electronics resellers and/or Kramer Electronics authorized service providers, please visit our web site at www.kramerelectronics.com or contact the Kramer Electronics office nearest you.

In order to pursue any remedy under this limited warranty, you must possess an original, dated receipt as proof of purchase from an authorized Kramer Electronics reseller. If this product is returned under this limited warranty, a return authorization number, obtained from Kramer Electronics, will be required. You may also be directed to an authorized reseller or a person authorized by Kramer Electronics to repair the product.

If it is decided that this product should be returned directly to Kramer Electronics, this product should be properly packed, preferably in the original carton, for shipping. Cartons not bearing a return authorization number will be refused.

Limitation on Liability

THE MAXIMUM LIABILITY OF KRAMER ELECTRONICS UNDER THIS LIMITED WARRANTY SHALL NOT EXCEED THE ACTUAL PURCHASE PRICE PAID FOR THE PRODUCT. TO THE MAXIMUM EXTENT PERMITTED BY LAW, KRAMER ELECTRONICS IS NOT RESPONSIBLE FOR DIRECT, SPECIAL, INCIDENTAL OR CONSEQUENTIAL DAMAGES RESULTING FROM ANY BREACH OF WARRANTY OR CONDITION, OR UNDER ANY OTHER LEGAL THEORY. Some countries, districts or states do not allow the exclusion or limitation of relief, special, incidental, consequential or indirect damages, or the limitation of liability to specified amounts, so the above limitations or exclusions may not apply to you.

Exclusive Remedy

TO THE MAXIMUM EXTENT PERMITTED BY LAW, THIS LIMITED WARRANTY AND THE REMEDIES SET FORTH ABOVE ARE EXCLUSIVE AND IN LIEU OF ALL OTHER WARRANTIES, REMEDIES AND CONDITIONS, WHETHER ORAL OR WRITTEN, EXPRESS OR IMPLIED. TO THE MAXIMUM EXTENT PERMITTED BY LAW, KRAMER ELECTRONICS SPECIFICALLY DISCLAIMS ANY AND ALL IMPLIED WARRANTIES, INCLUDING, WITHOUT LIMITATION, WARRANTIES OF MERCHANTABILITY AND FITNESS FOR A PARTICULAR PURPOSE. IF KRAMER ELECTRONICS CANNOT LAWFULLY DISCLAIM OR EXCLUDE IMPLIED WARRANTIES UNDER APPLICABLE LAW, THEN ALL IMPLIED WARRANTIES COVERING THIS PRODUCT, INCLUDING WARRANTIES OF MERCHANTABILITY AND FITNESS FOR A PARTICULAR PURPOSE, SHALL APPLY TO THIS PRODUCT AS PROVIDED UNDER APPLICABLE LAW.

IF ANY PRODUCT TO WHICH THIS LIMITED WARRANTY APPLIES IS A "CONSUMER PRODUCT" UNDER THE MAGNUSON-MOSS WARRANTY ACT (15 U.S.C.A. §2301, ET SEQ.) OR OTHER APPLICABLE LAW, THE FOREGOING DISCLAIMER OF IMPLIED WARRANTIES SHALL NOT APPLY TO YOU, AND ALL IMPLIED WARRANTIES ON THIS PRODUCT, INCLUDING WARRANTIES OF MERCHANTABILITY AND FITNESS FOR THE PARTICULAR PURPOSE, SHALL APPLY AS PROVIDED UNDER APPLICABLE LAW.

Other Conditions

This limited warranty gives you specific legal rights, and you may have other rights which vary from country to country or state to state.

This limited warranty is void if (i) the label bearing the serial number of this product has been removed or defaced, (ii) the product is not distributed by Kramer Electronics or (iii) this product is not purchased from an authorized Kramer Electronics reseller. If you are unsure whether a reseller is an authorized Kramer Electronics reseller, please visit our Web site at www.kramerelectronics.com or contact a Kramer Electronics office from the list at the end of this document.

Your rights under this limited warranty are not diminished if you do not complete and return the product registration form or complete and submit the online product registration form. Kramer Electronics thanks you for purchasing a Kramer Electronics product. We hope it will give you years of satisfaction.



For the latest information on our products and a list of Kramer distributors, visit our Web site where updates to this user manual may be found.

We welcome your questions, comments, and feedback.

Web site: www.kramerelectronics.com

E-mail: info@kramerel.com



SAFETY WARNING

Disconnect the unit from the power supply before opening and servicing



P/N: 2900-300093



Rev: 5