

Warnings

Lowel Prime Location™ LED equipment is a professional lighting system. Read these instructions, as well as accessory instructions and applicable warnings before operating.

- **Do not leave fixture unattended.** For fixed (stationary) use in studio's, theaters, and similar locations.
- **Not for household use.** Use only for photographic lighting (video & film imaging).
- **Always unplug unit before changing fuse.**
- **Never bypass plug's ground pin.**
- **Do not interfere with unit's ventilation.**
- **Do not operate unit with Accessory Barndoors closed.**
- **Make sure clamp is tightened at yoke.**
- **Always use with supplied Lowel AC Cable.**
- **Always use Safety Cable, when attaching to overhead pipes or grids.**
- **Make sure Accessory Lock is engaged to secure accessories.**

LED Warnings

- **Avoid looking directly** at the LED's for extended periods of time.
- **LED's take time to reach** standard operating output level, and frequently have slightly higher output during the first 1/2 hr, when powered up.

IP-65 Rating

(IP= Ingress Protection)

- **Prime Location LED is protected** against all dust, sand and dirt, as well as rain.

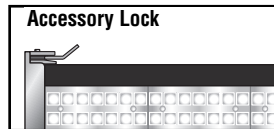

Specs & Performance: Daylight & Tungsten Models

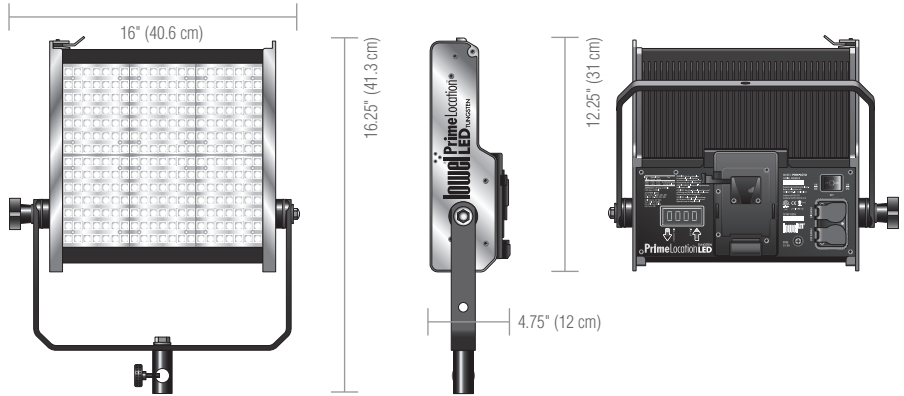

Supplied with:

Gel Frame, selected Battery Plate, Safety Cable, 5/8" Female Stand Fitting and 10' unswitched AC Cable (PC1-808). Other AC cable connection options are available.
Weight: 10.5 lbs (4.76 kg)

- Code: PL-01VTU** Tungsten color, V-lock plate
- Code: PL-01ATU** Tungsten color, Gold Mt plate
- Code: PL-01VDA** Daylight color, V-lock plate
- Code: PL-01ADA** Daylight color, Gold Mt plate

Performance

Each fixture has installed LEDs totalling 5800-6000 lumens

Daylight Model

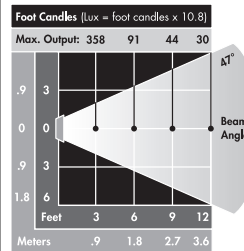

Tungsten Model

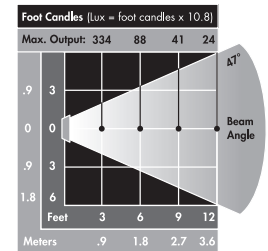

Beam Angles: Points at which intensity drops to 50% of maximum.
 Foot Candle readings taken at center of beam, using a Minolta CL-200 meter.

Mounting the Fixture

On Stand:

The recommended Lowel Stand for the light is the Uni-66 stand (UN-66) or larger. Set the stand risers at less than full extension, for most stable operation, and if tilting the light down, make sure 1 leg of the stand is extended straight out in front of the light for best balance.

Prime Locations' yoke is placed off center vertically in the unit. This is to allow a more full tilting range.

Make sure to tighten the side locking knob fully to prevent slippage.

Female 5/8" Stand-fitting:

For use on stand only. Allows mounting the fixture on 5/8" male stand stud. Stand fitting comes with a locking washer and a flat washer. Mount with the locking washer above the flat washer on the top side of the yoke, under the bolt head. Attach the female stand-fitting tightly and rotate yoke so it is now on the underside of the fixture. Tighten yoke, clamp locking lever, and place female stand-fitting over stand, making sure that its locking screw is loosened enough to allow the fitting to completely fit over the 5/8" stand stud. Tighten knob, making sure its screw is under the safety cut of the stand fitting stud. Add additional weight to base of stand for increased stability.

On Lighting Rail:

Due to the shortened yoke on Prime Location LED, when hanging the fixture from rail or pipe, fixture should be positioned upside down (see photo). If using with gel frame or any other front light controls installed, be sure that top corner accessory guide lock on the fixture is fully engaged. Attach clamp tightly to yoke of fixture, according to clamp mfrs. instructions. Hang clamp on pipe or grid and tighten the large screw so that the clamp and fixture are securely mounted.

Attach safety cable between the fixture and the rail for necessary security.



Fuses & Power Consumption

Note – Most electrical equipment briefly consumes a higher amount of electrical current during startup (ignition). Consult the below chart to confirm that your electrical wiring is sufficient for the fixtures used. All fuses must be rated at 250VAC.

Lowel Prime Location LED's auto-set from 90-240 VAC. Fixture consumes 82 Watts and has a Power Factor of .97

Model	Fuse	110V		240V	
		Nominal Current	Peak Ignition	Nominal Current	Peak Ignition
ALL	3 A / 250 V	0.714 A	0.97 A	0.403 A	0.61 A

Using Prime Location LED in Rain or Dust/Sand Storms

Prime Location LED's IP-65 rating means the fixture is sealed against dust & sand, and protected from water splashing on it from any direction, such as a rainstorm.

AC Use

When using the fixture with AC power, in rain or dust environments, it will be protected at the fixtures locking Powercon connector. Also ensure that the AC outlet the fixture is plugged into is protected. When not in use, make sure AC connections have their rubber covers securely in place.

DC Use

Prime Location's V-Lock or Gold Mount battery plates are also sealed against rain & dust when not in use.

For IP-65 protection you must also use batteries that are rated for IP-65 use.

Before attaching in damp environments, make sure the battery pins are wiped dry.

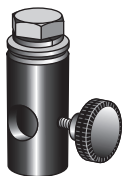

Female 5/8" Stand Fitting



Safety Cable

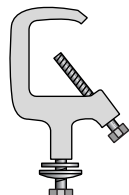

Lowel C-Clamp (FLS-803)

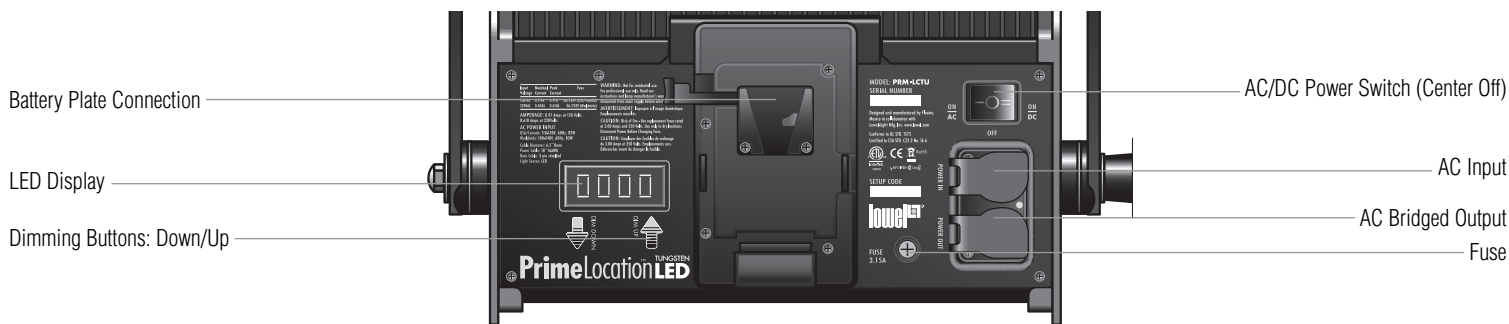

Prime Location LED Operation

AC / DC Power Switch

The Location Prime LED can be powered by AC, or DC with attached V-lock or Anton Bauer type battery. Press the Power Switch to the left side, for AC, or the right side for DC. In the switch's middle setting, the fixture is powered off.

AC Power In & Out

From the wall outlet, the Prime Location LED AC cable plugs into the top Powercon Connector, shown above, with a twist-lock action. Be sure the cable is securely locked. The fixture will auto-set itself from 90-240 VAC. (Use the proper cable for the country of use.) The AC Bridged Output allows jumper PowerCon cables to pass AC power from fixture to fixture in a chain of Location Prime LED's. This can be helpful when access to individual AC outlets is limited.

Note – When using the AC bridge PowerCon connection, pay attention to the total amperage consumption of the chain on the AC circuit. Do not overload.

Operation

Turning on the Power in either AC or DC operation switch causes the fixture to light at whatever dimming level it was at when last powered down (factory shipped at 100%). The unit will retain its previous dimming level even if unplugged.

Dimming to 100%

Lowel Prime Location fixtures can be dimmed manually on the rear of the unit, without visible color shift. To dim the light to a desired level, press the Up & Down buttons to set dimming level from 1-100.

Fuse

Always power down & unplug the fixture before changing its fuse. Open the fuse holder with a phillips head screwdriver to replace the fuse. Lowel Prime Location LED's use fuses rated at 3 Amps and 250 Volts.

Suggested Stands

Uni Sr. Stand

Code: UN-66
Weight: 3.3 lbs (1.5 kg)
Size: 22.5" (57.2 cm) folded.
Maximum height: 7' (2.2 m)

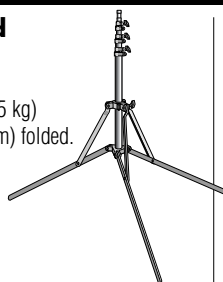

KS Jr. Stand

Code: DT-33
Maximum height: 7'7" (2.3 m),
Collapsed length: 2'4" (65 cm)
Weight: 3.5 lbs (1.6 kg)

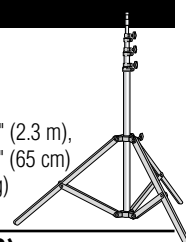

Safety Cable (3)

Code: CM-50
Weight: 2 oz (57 g)



Power

AC Use

Lowel Prime Location LEDs use Powercon connector AC cables. The fixture will auto-set itself to international voltages. See the listed cables if adapting for use in another country.

For IP-65 use, do not use switched AC cables.

Also, Prime Location LEDs can be ganged together using AC Bridging cables when AC outlets are scarce. With each fixture drawing approx 1 amp, a 20 amp circuit could accommodate 15+ fixtures. Do not overload AC circuits.

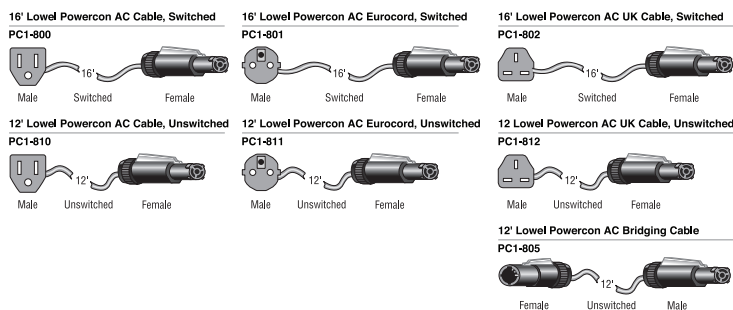

Prime Location Accessories

Lowel Prime Location™ Light Control Accessories mount on the front of the fixture using the 2 slots. The rear slot, closest to the LEDs, should be used for the gel frame, with the front slot used for either of the below listed accessories. Make sure top corner fixture Accessory Lock is engaged to secure accessories.

Barndoor Softening Set

Due to the 'multi point-source' nature of most LED fixtures, it is common to have an undesired multi-shadow effect, when using barndoors to trim the beam. This set includes a 4 way barndoor, subtle diffusion gel, and Gel-jawz clips, to minimize multi-shadow, while still allowing a visible barndoor cut.

Includes: 4 way adjustable Barndoor, Prime Lite Diffusion Gel, Lowel Gel-jawz (4)
Code: PL-120

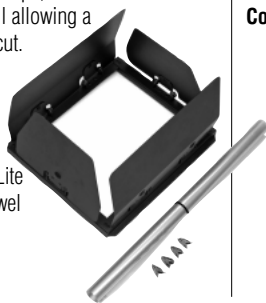

Honeycomb Grid

Honeycomb grids control the spill of the light, by attaching to the front of the fixture. The grid is available in 20 degree dispersion.

20° Honeycomb
Output Loss - approx 54%
Code: PL-132

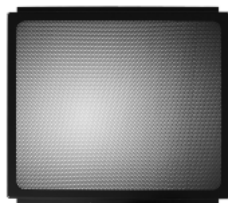

Battery Use

Battery run-time will vary with battery model, age and charging level. Both Location Prime battery plates are user removable & swappable, via a multi pin connector beneath the plate.

For use in rain or dust/sand, make sure battery is also rated for IP-65 use.

V-Lock Mount
Code: PLPLVLMNT

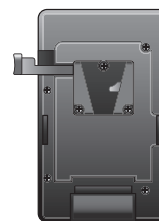

Anton Bauer Gold Mount
Code: PLABMNT



Problems, repairs & info

Repairs, problems, suggestions and requests for brochures/catalogs, instructions and parts lists can be handled through your Authorized Lowel Dealer/Distributor or directly through Lowel. Electrical repairs should

be made only by Lowel or by a qualified electrician. Lowel Prime Location LED equipment is a product of the ongoing collaborative relationship between Lowel-Light and Fluo-Tec, Mexico

Lowel-Light Manufacturing, Inc.

90 Oser Avenue, Hauppauge, N.Y. 11788
 Call: 800 645-2522 or 631-273-2500
 Fax: 631-273-2557
 e-mail: info@lowel.com
 www.lowel.com

