

# Marshall Electronics

Model No. **V-MD503**

Model No. **V-MD434**

---

Triple 5" Rack Mount Monitor  
Quad 4.3" Rack Mount Monitor

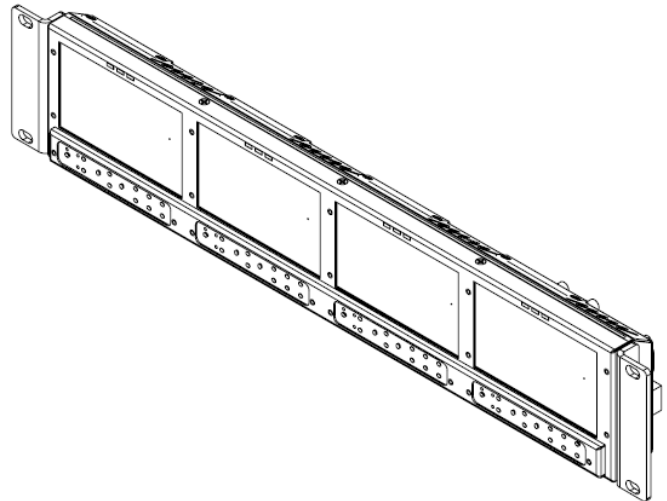
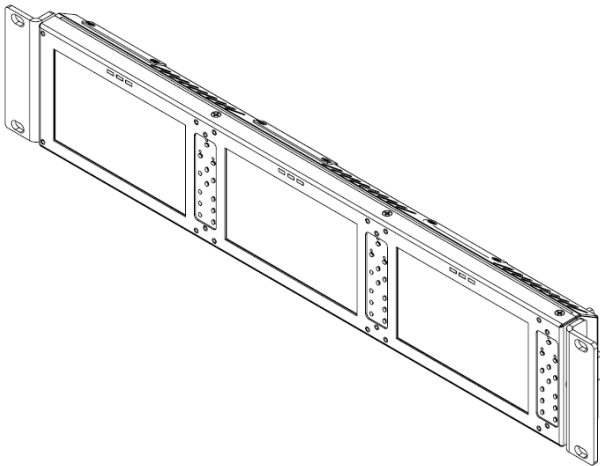

## Operating Instructions



# Table of Contents

Product Overview .....	5
Features .....	5
Installation and Accessories .....	6
Monitor Front .....	7
Monitor Rear .....	8
Compatible Input Formats .....	9
Menu and Navigation .....	10
Video Configuration Submenu .....	10
Marker Configuration Submenu .....	13
Filter Configuration Submenu .....	16
System Configuration Submenu .....	17
Function Presets Submenu .....	18
IMD & Tally Configuration .....	19
System Information Submenu .....	20
Network Configuration Submenu .....	20
Network Control Page .....	22
Status Tab .....	22
Menu Tab .....	23
Display Tab .....	29
Keypad Tab .....	30
Network Tab .....	31
Global Tab .....	34
Specifications .....	35
Dimensions .....	36
Maintenance .....	37
Warranty .....	37

**This page intentionally left blank**

# Product Overview

---

Marshall Electronics proudly presents the **MD series** of rack mount monitors that offer a flexible modular solution to system integration. These new rack-mountable monitors can be configured with a variety of video inputs that can be "swapped" or interchanged in the field based on your evolving needs and requirements. This eliminates the need to upgrade or replace equipment when a different input or application is required. This "future proof" solution provides flexibility and reassurance when necessary, especially in multi-monitor rack mount units.

## Features

---

- **High-Resolution 5" and 4.3" Panel**

The V-MD503 and V-MD434 feature an all-digital TFT-MegaPixel active matrix LCD system with 1.15 million pixels. The LCD panels feature a brightness of 300 cd/m<sup>2</sup> and 200 cd/m<sup>2</sup> and contrast ratios of 6000:1 and 400:1, respectively making the display ideal in a variety of environments and lighting conditions.

- **Modular Input Design**

Each monitor has rear slots to support various Digital, Optical and Analog video input modules.

- **Multi-Format Compatibility**

Accepted formats include 480i, 576i, 720p, 1035i, 1080i. 3G/HD/SDI, HDMI, DVI-I, Optical inputs available as optional Input Modules. Please contact Marshall Electronics for availability.

- **ColorMatch Conversion with Color Temperature Adjustment**

Emulation of SMPTE-C/EBU color space allows these monitors to replace any broadcast CRT monitor. Presets include D65, D55 and D93. Bias

and Gain adjustment for each color enables precise color matching and white balance.

- **False Color Filter, and other Advanced Features**

False Color filter, Aspect ratio settings, blue-only mode, and monochrome mode are a few of the advanced features which make the V-MD503 and V-MD434 at home in any broadcast environment. Pixel-to-Pixel mode also allows native display of any incoming image format.

- **Flexible Screen Markers**

A variety of screen markers in 4:3, 16:9, and full screen modes allow accurate monitoring of the different aspect ratios used in broadcast environments.

- **User-Definable Function Buttons**

Two user-definable function buttons on the front-panel allow quick access to numerous settings and features including false color filter, aspect ratio, screen markers, monochrome mode, color temperature and more.

# Installation and Accessories

---

Carefully unpack the V-MD503 / V-MD434 monitor and verify that the following items are included:

- V-MD503 / V-MD434 Monitor
- V-PS12-5V-1 Twist Lock Connector
- Operating Instructions

Inspect the unit for any physical damage that may have occurred during shipping. Should there be any damage, immediately call Marshall Electronics Customer Service at (800) 800-6608. If you are not located within the continental United States, call +1 (310) 333-0606.

# Monitor Front

---

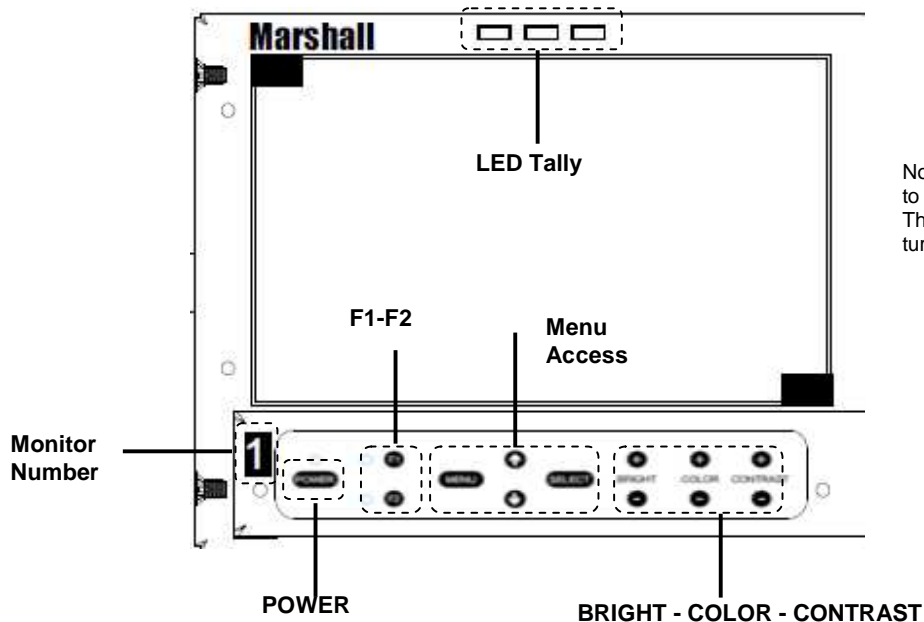

- **[Power]**

Turn the monitor off or on by pressing the power button. The LED on the power button is at full illumination when the monitor is OFF.

- **[F1 - F2]**

Two user-definable function buttons can be used for direct access to various settings. Functions are assigned using the on-screen menu

- **Menu Access**

Use the Menu, ▲, ▼, and **Select** buttons to display and navigate the on-screen menu.

- **[BRIGHT, COLOR, CONTRAST]**

The BRIGHT, COLOR and CONTRAST buttons function as Image Adjustment buttons. The status of each image adjustment parameter is shown on the top left of the screen, with values ranging from 0 to 100. Pressing a button once displays the current value. Pressing a button twice resets the corresponding adjustment to the default setting.

- **Monitor Number**

This silkscreened number will indicate the panel number on the V-MD503 system.

- **LED Tally**

Three LED tally lights (yellow, red, green) are available above the screen. Each tally light is controlled by the Tally Connector on the back of the monitor.

# Monitor Rear

Note: This image is specific to the V-MD434 monitor. Please refer to the Specifications portion of the manual for Tally and Power details.

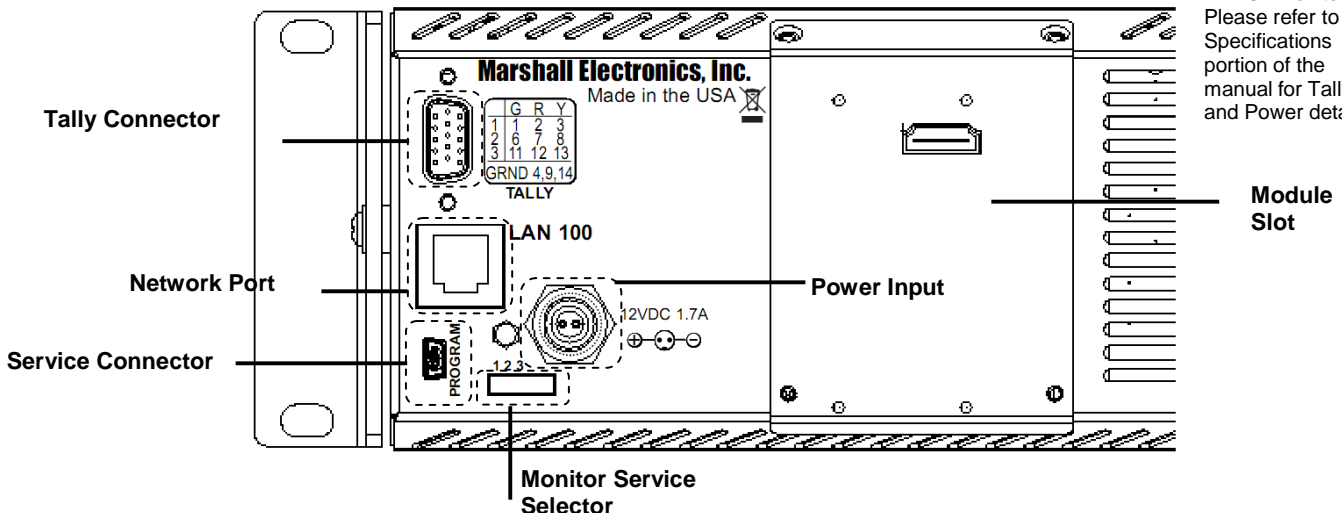

## ▪ Tally Connector

The LED tally can be activated via the HD-15 connector by connecting the corresponding pin to ground. A variety of external devices can be used to perform the contact closure. No additional power should be supplied to the HD-15 port.

## ▪ Network Port

The Network Port is used to access the Network Control Page for the V-MD434 or V-MD503 monitor. Use a regular RJ45 Ethernet cable to connect the V-MD monitor to your network. Please see the **Network Configuration Submenu** section of this manual for further connection details.

## ▪ Service Connector

This is for factory and Upgrade use ONLY. Please contact Marshall Electronics for further information on upgrading the V-MD monitor.

## ▪ Monitor Service Selector

This, in conjunction with the Service Connector, serves to control which monitor to Service. Please contact Marshall Electronics before any attempted service to this monitor.

## ▪ Power Input

Connect the 12 VDC input to the Twist-Lock power input connector. Power can be supplied from the included power supply or from a variety of DC sources supplying at least 5.0 Amps at 12 Volts.

IMPORTANT: If using a power source other than the included power supply, be sure that the polarity of the DC input is correct:

- Pin 1: +12 VDC
- Pin 2: GND

## ▪ Module Slot

The V-MD monitor comes with Module Slots for Marshall Electronics' line of future proof Input Modules. Please contact Marshall Electronics for a list of compatible Input Modules.



# Compatible Input Formats

---

The following standards are supported by the V-MD434 or V-MD503 monitors and available input modules:

## MD-3GSDI-B – 3G/HD/SDI Input Module

### SD-SDI –

480i 59.94, 576i 50

### HD-SDI –

720p (60 / 59.94 / 50 / 30 / 29.97 / 25)

1080i (60 / 59.94 / 50)

1080p (30 / 29.97 / 25 / 24 / 24sF / 23.98 / 23.98sF)

### 3G-SDI – YCbCr (4:2:2) 10 Bit – Level A and B

1080p (60 / 59.94 / 50)

### YCbCr/RGB (4:4:4) 10 Bit – Level A and B

1080i (60 / 59.94 / 50)

1080p (30 / 29.97 / 29.97sF / 25 / 25sF / 24 / 24sF / 23.98 / 23.98sF)

## MD-HDSIx2-B – Two-channel HDSDI Input Module with Switched Output

### SD-SDI –

480i 59.94, 576i 50

### HD-SDI –

720p (60 / 59.94 / 50 / 30 / 29.97 / 25)

1080i (60 / 59.94 / 50)

1080p (30 / 29.97 / 25 / 24 / 24sF / 23.98 / 23.98sF)

## Menu and Navigation

---

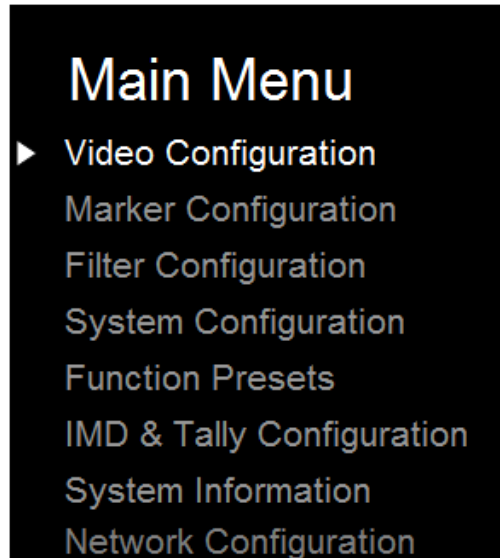

Access the main menu by pushing and holding the **MENU** button on the front panel of the monitor.

- Step through menu items using the ▲ and ▼ buttons.
- Choose a submenu or select a menu item by pressing **SELECT**.
- Return to the previous menu by pressing **MENU**.
- Exit the main menu by pressing **MENU**. The menu will automatically time out after 15 seconds.

Only unit screen 1 will have the Network Configuration option available. All network settings can be configured from unit screen 1.

## Video Configuration Submenu

---

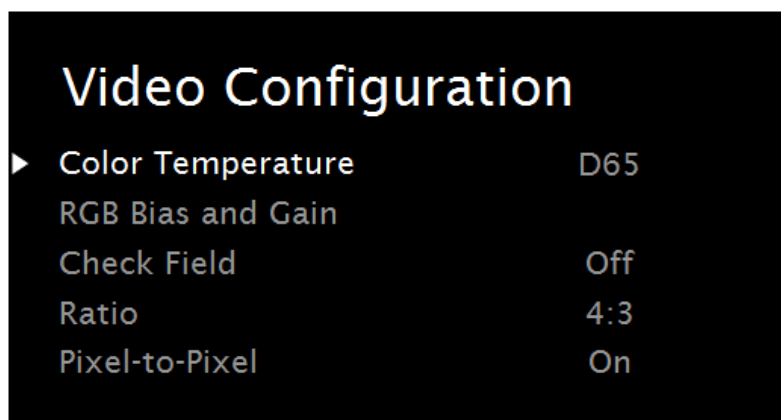

## ■ Color Temperature

Use this setting to choose one of three color temperature presets:

- D55 (5500K)
- D65 (6500K)
- D93 (9300K)
- USER (Adjustable Color Bias and Gain)
- Linear (No processing is applied to the panel)

Use this setting to enable monochrome mode. Only the luminance of the image will be displayed as a grayscale picture.

## ■ RGB Bias and Gain

Select this submenu to fine-tune the monitor's color balance (R, G, B). This should only be done by someone experienced with video engineering, as this will alter the overall color shading of the screen. The purpose is to allow color matching to other types of monitors and/or displays. Note: The Color Temperature preset will automatically switch to USER when Color Bias settings are adjusted. It is normal for color bias adjustments to be very subtle.

When selecting the RGB Bias and Gain submenu, gain adjustment indicators will appear at the top of the screen, and bias adjustment indicators will appear at the bottom of the screen:

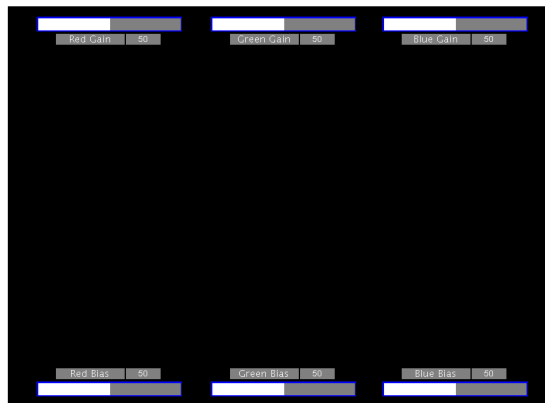

*RGB Bias and Gain*

Use the ▲ and ▼ buttons to select each individual bias or gain control. Press SELECT to begin adjusting the control. Use the ▲ and ▼ buttons to increase or decrease the value.

Alternately, the image adjustment buttons (Brightness, Color, Tint, Contrast) can be used to easily adjust the bias and gain settings as shown below. The buttons affect whichever row of controls (gain or bias) is currently selected.

## ■ Check Field

Use the check field modes for monitor calibration or to analyze individual color components of an image. In Monochrome mode, all color is disabled and only a grayscale image is shown. In Blue, Green, and Red check field modes, only the selected color will be shown.

Use the following procedure when calibrating the monitor to SMPTE color bars with the following procedure:

1. Allow the monitor to warm up for at least 5-10 minutes.
2. Display SMPTE split-field color bars on the monitor using an external source.
3. Enable **Monochrome mode**.
4. Locate the pluge pattern (super black, black, and gray bars) at the lower-right corner of the screen. Adjust the **Brightness** button until there is no visible difference between the super black and black bars, but the gray bar is still visible.

5. Adjust the **Contrast** button until an even grayscale appears along the top bars.
6. Disable **Monochrome mode**.
7. Enable **Blue Check Field mode** and adjust the **Color** button so that the outermost bars (white and blue) appear to match in brightness.
8. Composite NTSC only: Adjust the **Tint** button until the third bar from the left (cyan) and the third bar from the right (magenta) appear to match in brightness.
9. Disable **Blue Check Field mode**.

## ■ Ratio Settings

Use to switch between Full Screen, 4:3 and 16:9 aspect ratios.

As the V-MD434 and V-MD503 monitors have a native resolution of 800 x 480 RGB pixels, incoming images are automatically scaled to fit the screen:

- In Full Screen mode, images are scaled to fill the entire screen (800 x 480).
- In 4:3 mode, images are scaled to fill the center 4:3 portion of the screen (640 x 480). With a 16:9 source, images will be centered with a black letter-box added on the left and right sides.
- In 16:9 mode, images are scaled to a 16:9 portion of the screen (800 x 450), with a black letter-box added top and bottom.

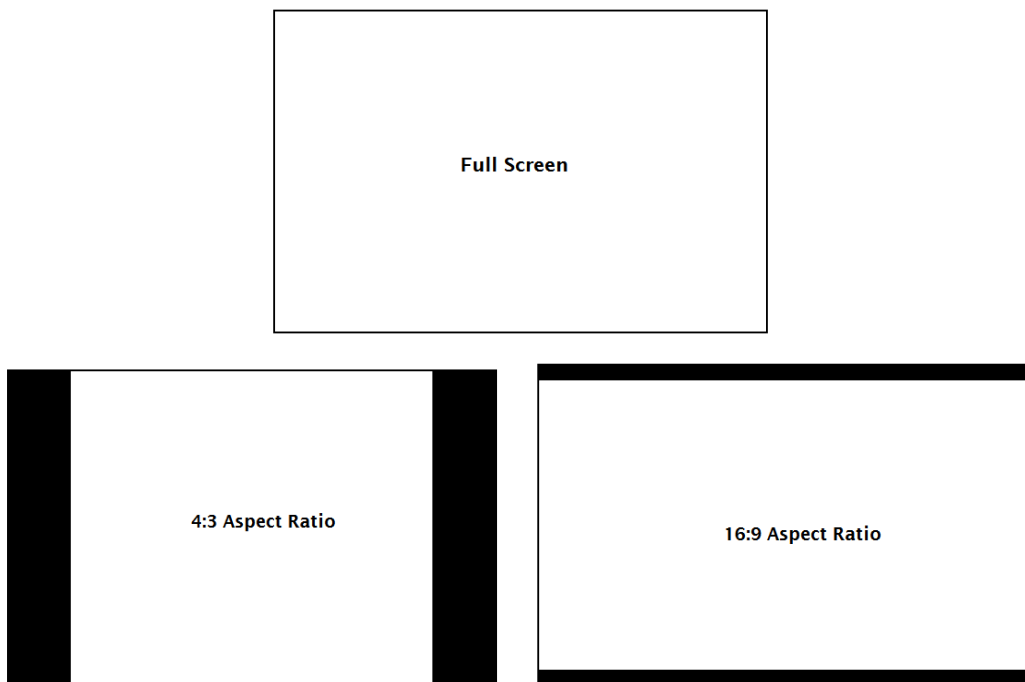

Note: The aspect ratio setting is ignored when Pixel-to-Pixel mode is enabled.

## ■ Pixel-to-Pixel

Use this setting to enable Pixel-to-Pixel mode.

This Pixel-to-Pixel mode bypasses the monitor's internal scaling function and displays incoming images in their native resolution and aspect ratio, with a one-to-one mapping:

- For incoming formats smaller than the native resolution of the LCD panel (800 x 480), the image will be displayed in the center of the screen using only the necessary LCD pixels. For example, NTSC images will occupy exactly 720 x 480 pixels. The surrounding pixels will be black.
- For incoming formats exceeding 800 x 480 pixels, only the center 800 x 480 of the incoming image will be displayed occupying the whole screen, with the remainder of the picture cropped. For example, 1080i formats will both be cropped to 800 x 480 and displayed full-screen.

Note: Pixel-to-Pixel mode disables aspect ratio control and H/V Delay.

## Marker Configuration Submenu

---

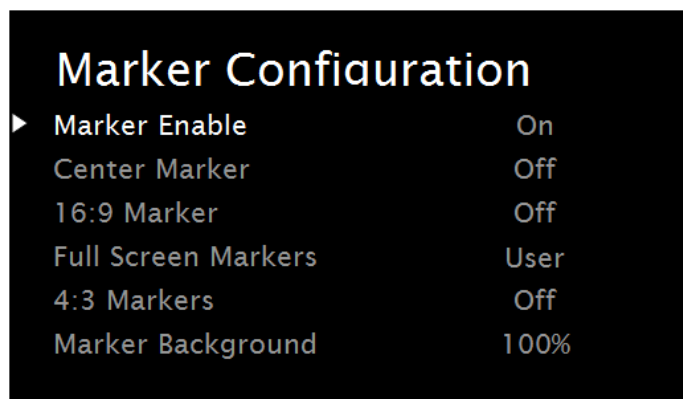

*Marker Configuration Submenu*

### ■ Markers

Use this setting to enable or disable all on-screen markers. This setting affects the center marker, full screen markers, 16:9 markers and 4:3 markers.

### ■ Center Marker

Use this setting to display a center marker on the screen.

### ■ 16:9 Markers

Use these settings to superimpose one of 12 markers on the screen when in 16:9 mode.

- 4:3
- 13:9
- 14:9
- 1.85:1
- 2.35:1
- 95% Safe
- 93% Safe
- 90% Safe
- 88% Safe
- 85% Safe
- 80% Safe

### 16:9 Marker Examples:

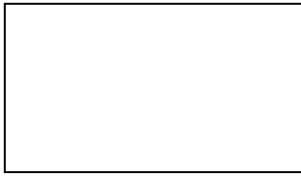

OFF (No Marker)

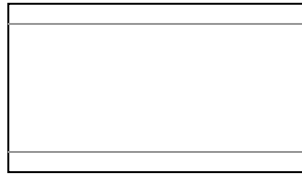

2.35:1 Aspect Ratio



4:3 Aspect Ratio Marker

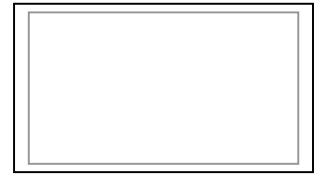

90% Safe Area

### ■ Full Screen Markers

Use these settings to superimpose one of 6 markers on the screen when in Full Screen mode.

- 95% Safe
- 93% Safe
- 90% Safe
- 88% Safe
- 85% Safe
- 80% Safe

### ■ 4:3 Markers

Use this setting to superimpose one of 5 markers on the screen when in 4:3 mode.

- 95% Safe Area
- 93% Safe Area
- 90% Safe Area
- 88% Safe Area
- 85% Safe Area
- 80% Safe Area

### 4:3 Marker Examples:



OFF (No Marker)

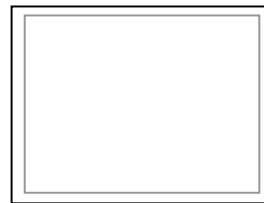

90% Safe Area

### ■ Marker Background

Use this setting to choose how selected markers are displayed on the screen. :

- 0% The marker is superimposed on the complete image.
- 25% Image area beyond the marker is shown at 25% intensity.
- 50% Image area beyond the marker is shown at 50% intensity.
- 75% Image area beyond the marker is shown at 75% intensity.
- 100% Image area beyond the marker is shown at 100% intensity (black).

**Example (80% Marker in 4:3 Mode):**

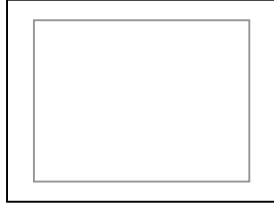

*0% Background*



*100% Background*

# Filter Configuration Submenu

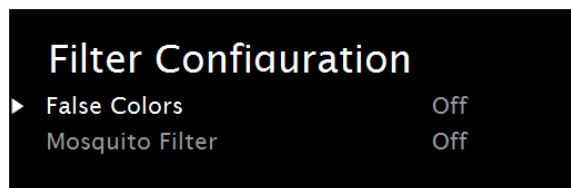

## False Colors

The V-MD434 and V-MD503 have a false color filter to aid in the setting of camera exposure. As the camera Iris is adjusted, elements of the image will change color based on the luminance or brightness values. This enables proper exposure to be achieved without the use of costly, complicated external equipment. To best utilize this feature, you must understand the color chart below and have a basic understanding of camera exposure. Normally, when shooting subjects like people, it is common practice to set exposure of faces to the equivalent of approximately 56 IRE. The false color filter will show this area as the color PINK on the monitor. Therefore, as you increase exposure (open the IRIS), your subject will change color as indicated on the chart: PINK, then GREY, then a few shades of YELLOW. Over exposed subjects (above 101 IRE) on the monitor will be shown as RED. In addition, underexposed subjects will show as DEEP-BLUE to DARK-BLUE, with clipped-blacks indicated with a FUCHSIA-like color. Lastly, the color GREEN is used to indicate elements of the image that are approximately 45 IRE. This represents a 'neutral' or 'mid-level' exposure commonly used for objects (not people).

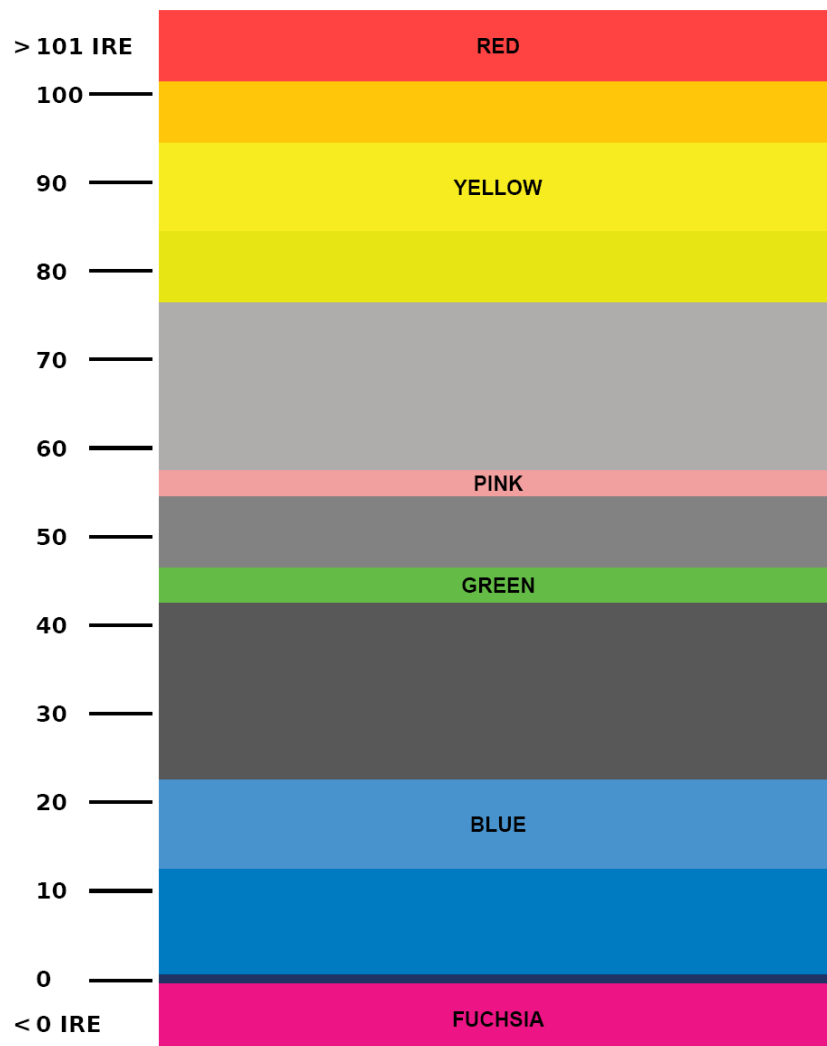



## ■ Mosquito Filter

Use this setting to filter out “Mosquito Noise” – an artifact that appears as specs around edges of objects. This artifact is the result of video that has been compressed at some point. Video sources from DVD-Players, PDA's, Digital Cable Boxes, Camcorders, etc. often have this artifact.

## System Configuration Submenu

---

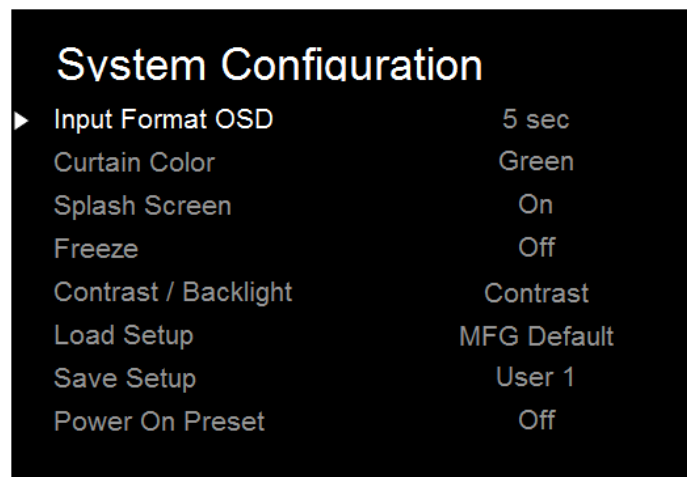

*System Configuration Submenu*

## ■ Input Format OSD

Use this option to enable on-screen display of input/format status in the upper-left corner of the screen.

## ■ Curtain Color

Use this option to change the curtain color on the monitor. This curtain color is what you see when there is no signal input to the monitor.

## ■ Splash Screen

Use this option to enable or disable the Marshall Electronics Inc. splash screen seen when the monitor is first powered on.

## ■ Freeze

Use the Freeze function to “freeze” the current image on the screen. Select this menu item again (Unfreeze) to return to the real-time video input.

## ■ Contrast / Backlight

Use this feature to choose between controlling the Contrast of the image or the intensity of the panel's Backlight with the CONTRAST button on your monitor. **Note:** While the Contrast control moves up and down at intervals of 1, the Backlight control will move up and down at intervals of 2, from 0-100.

## ■ Load Setup

Select this menu item to reset all adjustments and menu settings to the factory default configuration.

### ■ **Save Setup**

Select this menu item to reset all adjustments and menu settings to the factory default configuration.

## Function Presets Submenu

---

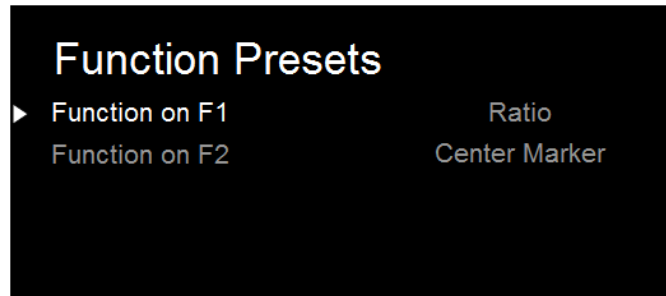

### ■ **User-Definable Function Buttons**

Use the **Function on F1, F2** menu items to define each function button on the front panel of the monitor. The following options are available for each button:

- Ratio
- Check Field
- Mosquito Filter
- False Colors
- Freeze Input
- Aspect Markers
- Center Marker
- Marker Enable
- Pixel-to-Pixel

# IMD & Tally Configuration

---

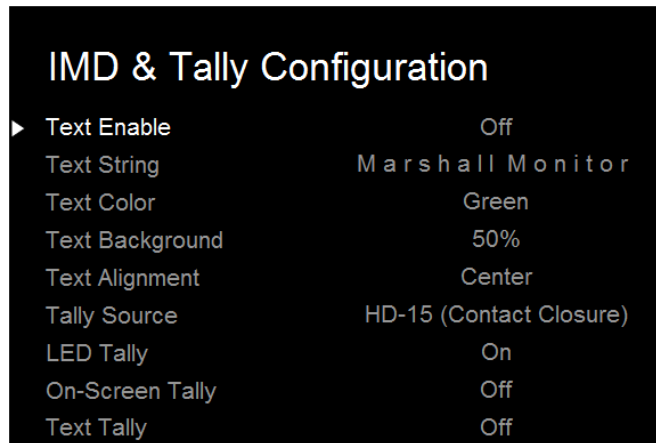

IMD & Tally Configuration	
▶ Text Enable	Off
Text String	Marshall Monitor
Text Color	Green
Text Background	50%
Text Alignment	Center
Tally Source	HD-15 (Contact Closure)
LED Tally	On
On-Screen Tally	Off
Text Tally	Off

## ■ Text Enable

Use the Text Enable function to turn the MD Text feature ON. This will cause the Text String to appear on the lower portion of the screen.

## ■ Text String

Use this field to enter your own 16 character string on the screen.

## ■ Text Color

Use this field to change the color of the text in the Text String field.

## ■ Text Background

Use this field to change the opacity of the background behind the text in the Text String field. A value of 0% will cause the background to appear black. A value of 100% will make the background invisible.

## ■ Text Alignment

Use this field to change the alignment of the text string mentioned above.

## ■ Tally Source

Use this setting to change the source of the LED tally lights. Choosing the HD-15 (Contact Closure) option will render the LAN Tally interface disabled. Choosing the LAN 100 option will also render the HD-15 (Contact Closure) connector inoperable.

## ■ LED Tally

Use the LED Tally option to turn the physical LED tally lights ON or OFF.

## ■ On-Screen Tally

Use the On-Screen Tally option to turn the On-Screen tally ON or OFF.

### ■ Text Tally

Use the Text Tally option to lock the Text String color to the same color as the current Tally color. When there is no specific tally color enabled, the text string will default to the Text Color selection made in the IMD & Tally Configuration menu option.

## System Information Submenu

---

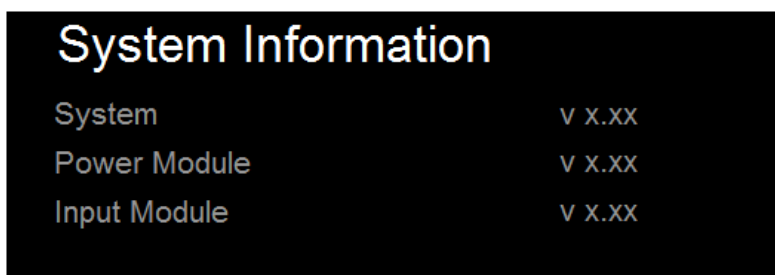

### ■ System

This shows the System firmware version of your monitor.

### ■ Power Module

This shows the Power Module firmware version of your monitor.

### ■ Input Module

This shows your module version and the firmware version of your module. If no module is present, the words MODULE NOT INSTALLED will appear in parentheses.

## Network Configuration Submenu

---

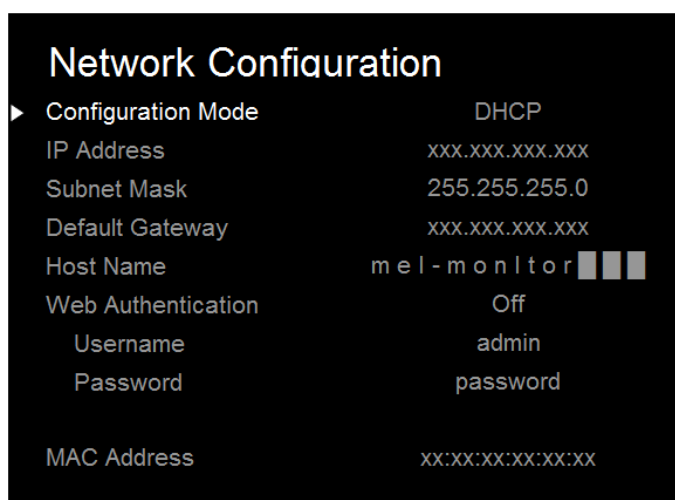

The Network Configuration Submenu only appears on the first display of each V-MD434 or V-MD503 monitor. This Submenu is responsible for the network settings of the entire monitor.

## ■ Configuration Mode

Use this setting to choose between a DHCP IP address retrieval or Manual IP address selection.

## ■ IP Address

When using a Manual Configuration Mode, use this field to assign a specific IP address for your monitor. When in DHCP Configuration Mode, this field will automatically be filled by the IP address assigned by your network.

## ■ Subnet Mask

When using a Manual Configuration Mode, use this field to assign a specific Subnet Mask for your monitor. When in DHCP Configuration Mode, this field will automatically be filled by the Subnet Mask assigned by your network.

## ■ Default Gateway

When using a Manual Configuration Mode, use this field to assign a specific Default Gateway for your monitor. When in DHCP Configuration Mode, this field will automatically be filled by the Default Gateway assigned by your network.

## ■ Host Name

Use this field to enter a Host Name for your monitor. You may choose up to 16 alphanumeric characters for the host name.

## ■ Web Authentication

Use this field to turn Web Authentication ON or OFF. If turned on, you will be asked to select a Username and Password in the subsequent fields.

**Username:** 16 Alphanumeric character string

**Password:** 16 Alphanumeric character string

## ■ MAC Address

This field will show the MAC address associated with the particular monitor in question.

# Network Control Page

---

The V-MD434 and V-MD503 monitors allows you to fully control all settings via the standard Lan100 ethernet port on the rear of the monitor. Simply connect the V-MD503 or V-MD434 monitor to your network with an Ethernet patch cable and access the monitor's host name or IP Address via any web browser on your computer and take control.

# Status Tab

---

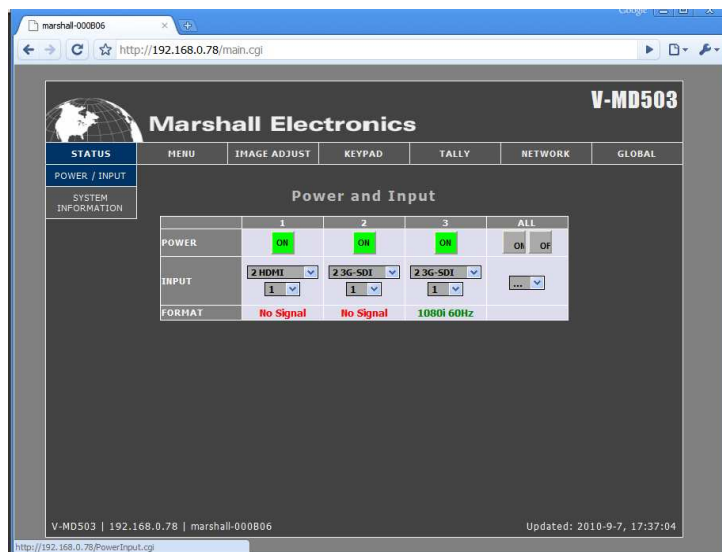

## Power / Input Page

### ■ Power

Use this row to determine the Power status for each of the screens on the unit. A green ON box indicates that the screen is currently on. A red OFF box indicates that the unit is off. Press the box to toggle the screen ON or OFF. The last element, ALL, controls all screens on the monitor.

### ■ Input

The input field allows you to identify the module type currently in your monitor's slot. The ALL column in this row does not apply.

### ■ Format

This text field determines the input format currently being displayed on a particular monitor screen. A No Signal string indicates that there is no signal present.

## System Information

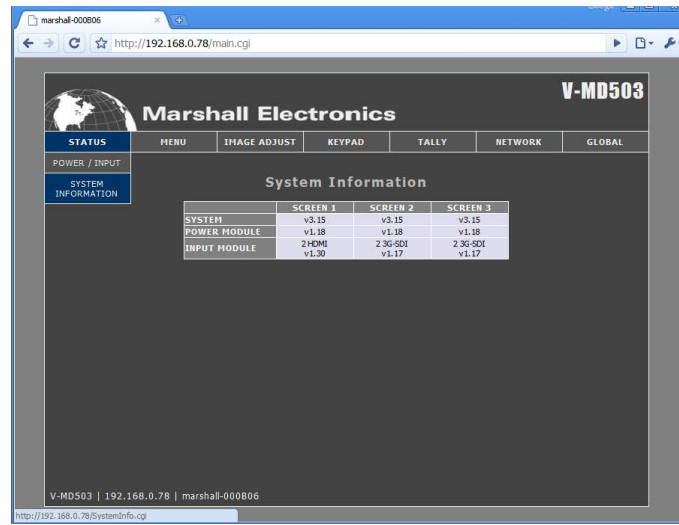

- **System**

This shows the System firmware version of each individual screen on your monitor.

- **Power Module**

This shows the Power Module firmware version of your monitor.

- **Input Module**

This text field determines the input format currently being displayed on a particular monitor screen. A No Signal string indicates that there is no signal present.

## Menu Tab

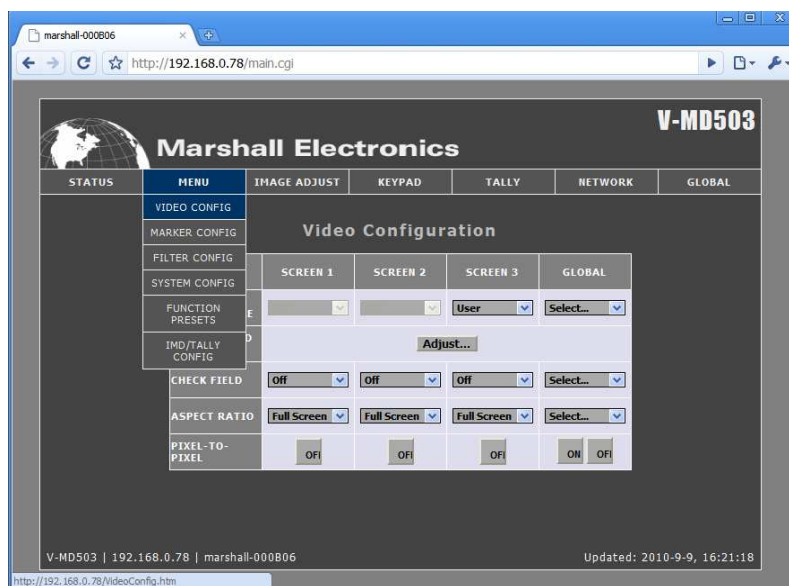

## Video Config

Video Configuration				
	SCREEN 1	SCREEN 2	SCREEN 3	GLOBAL
COLOR TEMPERATURE	<input type="text"/>	<input type="text"/>	D65	Select...
RGB BIAS AND GAIN	Adjust...			
CHECK FIELD	Off	Off	Off	Select...
ASPECT RATIO	16:9	16:9	4:3	Select...
PIXEL-TO-PIXEL	OFF	OFF	OFF	ON OFF

### ■ Color Temperature

Use this row to determine the current Color Temperature preset being used on each screen. This row can also be used to change the Color Temperature preset used on an individual screen level or the global level under the GLOBAL column.

### ■ RGB Bias and Gain

Click the Adjust button in this row to move into the RGB Bias and Gain controls. This is covered in depth later in this manual, in the Image Adjust submenu.

### ■ Check Field

Use this row to determine the current Check Field mode being used on an individual screen. The drop down menu in this row can also be used to enable a Check Field color type on the individual screen level or the global level under the GLOBAL column.

### ■ Aspect Ratio

Use this row to determine the current Aspect Ratio mode being used on an individual screen. The drop down menu in this row can also be used to enable a particular Aspect Ratio on the individual screen level or the global level under the GLOBAL column.

### ■ Pixel-to-Pixel

Use this row to determine the current state of the Pixel-to-Pixel feature of the monitor. Pressing one of the boxes under each Screen type will either turn Pixel-to-Pixel mode OFF or ON. This can also be changed on the global level under the GLOBAL column.



## Marker Config

Marker Configuration				
	SCREEN 1	SCREEN 2	SCREEN 3	GLOBAL
MARKER ENABLE	<input checked="" type="checkbox"/>	<input checked="" type="checkbox"/>	<input checked="" type="checkbox"/>	<input type="checkbox"/> <input type="checkbox"/>
CENTER MARKER	<input type="checkbox"/>	<input checked="" type="checkbox"/>	<input checked="" type="checkbox"/>	<input type="checkbox"/> <input type="checkbox"/>
16:9 MARKERS	<input type="text" value="Off"/>	<input type="text" value="Off"/>	<input type="text" value="Off"/>	<input type="text" value="Select..."/>
FULL SCREEN MARKERS	<input type="text" value="Off"/>	<input type="text" value="Off"/>	<input type="text" value="85% Safe"/>	<input type="text" value="Select..."/>
4:3 MARKERS	<input type="text" value="Off"/>	<input type="text" value="Off"/>	<input type="text" value="Off"/>	<input type="text" value="Select..."/>
MARKER BACKGROUND	<input type="text" value="100%"/>	<input type="text" value="100%"/>	<input type="text" value="100%"/>	<input type="text" value="Select..."/>

### ■ Marker Enable

Use this row to turn the screen markers on an individual screen ON or OFF. This can also be changed on the global level under the GLOBAL column.

### ■ Center Marker

Use this row to turn the Center Marker on an individual screen ON or OFF. This can also be changed on the global level under the GLOBAL column.

### ■ 16:9 Markers

Use this row to determine the current status of the 16:9 markers on each individual panel. The drop down menus in this row can also be used to select 16:9 screen markers on the individual screen level or the global level under the GLOBAL column.

### ■ Full Screen Markers

Use this row to determine the current status of the Full Screen markers on each individual panel. The drop down menus in this row can also be used to select Full Screen markers on the individual screen level or the global level under the GLOBAL column.

### ■ 4:3 Markers

Use this row to determine the current status of the 4:3 markers on each individual panel. The drop down menus in this row can also be used to select 4:3 screen markers on the individual screen level or the global level under the GLOBAL column.

### ■ Marker Background

Use this row to determine the current status of the transparency settings of the screen markers on each individual panel. The drop down menus in this row can also be used to change your transparency values. This can also be done on the global level under the GLOBAL column.

## Filter Config

Filter Configuration				
	SCREEN 1	SCREEN 2	SCREEN 3	GLOBAL
FALSE COLORS	<input type="checkbox"/>	<input type="checkbox"/>	<input type="checkbox"/>	<input type="checkbox"/> <input type="checkbox"/>
MOSQUITO FILTER	<input type="checkbox"/>	<input type="checkbox"/>	<input type="checkbox"/>	<input type="checkbox"/> <input type="checkbox"/>

### ■ False Colors

Use this row to turn the False Color filter on an individual screen ON or OFF. This can also be changed on the global level under the GLOBAL column.

### ■ Mosquito Filter

Use this row to turn the Mosquito Filter on an individual screen ON or OFF. This can also be changed on the global level under the GLOBAL column.

## System Config

System Configuration				
	SCREEN 1	SCREEN 2	SCREEN 3	GLOBAL
INPUT FORMAT OSD	<input type="text" value="On"/>	<input type="text" value="5 sec"/>	<input type="text" value="On"/>	<input type="text" value="Select..."/>
CURTAIN COLOR	<input type="text" value="Blue"/>	<input type="text" value="Blue"/>	<input type="text" value="Blue"/>	<input type="text" value="Select..."/>
SPLASH SCREEN	<input checked="" type="checkbox"/>	<input checked="" type="checkbox"/>	<input checked="" type="checkbox"/>	<input type="checkbox"/> <input type="checkbox"/>
FREEZE INPUT	<input type="checkbox"/>	<input type="checkbox"/>	<input type="checkbox" value="OFF"/>	<input type="checkbox"/> <input type="checkbox"/>
CONTRAST/BACKLIGHT	<input type="text" value="Contrast"/>	<input type="text" value="Contrast"/>	<input type="text" value="Contrast"/>	<input type="text" value="Select..."/>
LOAD SETUP	<input type="text" value="MFG Defaul"/>	<input type="text" value="MFG Defaul"/>	<input type="text" value="MFG Defaul"/>	<input type="text" value="Select..."/>
SAVE SETUP	<input type="text" value="User 1"/>	<input type="text" value="User 1"/>	<input type="text" value="User 1"/>	<input type="text" value="Select..."/>
	Setup Name: <input type="text" value="User 1"/>	Setup Name: <input type="text" value="User 1"/>	Setup Name: <input type="text" value="User 1"/>	Setup Name: <input type="text"/>
	<input type="button" value="Save"/>	<input type="button" value="Save"/>	<input type="button" value="Save"/>	<input type="button" value="Save"/>
POWER-ON SETUP	<input type="text" value="Off"/>	<input type="text" value="Off"/>	<input type="text" value="Off"/>	<input type="text" value="Select..."/>

### ■ Input Format OSD

Use this row to turn determine the Input Format OSD state. Use the drop down menu to choose from the available options. This can also be changed on the global level under the GLOBAL column.

### ■ Curtain Color

Use this row to turn determine the current Curtain Color state. Use the drop down menu to choose from the available options. This can also be changed on the global level under the GLOBAL column.

### ■ Splash Screen

Use this row to turn the splash screen on each individual panel ON or OFF. This can also be changed on the global level under the GLOBAL column.

■ **Freeze Input**

Use this row to turn the freeze input function on each individual panel ON or OFF. This can also be changed on the global level under the GLOBAL column.

■ **Contrast/Backlight**

Use this row to select what function should be controlled by the CONTRAST buttons on the physical unit or on the Network Control Page. This can be changed for each individual panel, or on the global level under the GLOBAL column.

■ **Load Setup**

Use this row to load any of the Setup configuration files available on the monitor. This can be selected for each individual panel, or on the global level under the GLOBAL column. When selecting from the GLOBAL column, each individual panel will load its own individual settings. For example, if you select User 3 from the GLOBAL column, each panel will load a separate User 3 setting, not a single file.

■ **Save Setup**

Use this row to Save the current configuration on each individual panel or on the global level. When selecting from the GLOBAL column, each individual panel will save its own individual settings. For example, if you select User 3 from the GLOBAL column, each panel will save a separate User 3 setting, not a single file.

■ **Setup Name**

Use this dialogue box to rename the User configuration files available. Choose up to 16 characters to customize the names of the User configuration files. You can also assign each User configuration file a name globally. The name you select in this dialogue box will be stored and available from the Load and Save setup options previously mentioned.

■ **Power-On Setup**

Use this row to select the settings to be loaded when power is applied to the V-MD monitor. This can be selected for each individual panel or globally in the GLOBAL column.

Function Presets

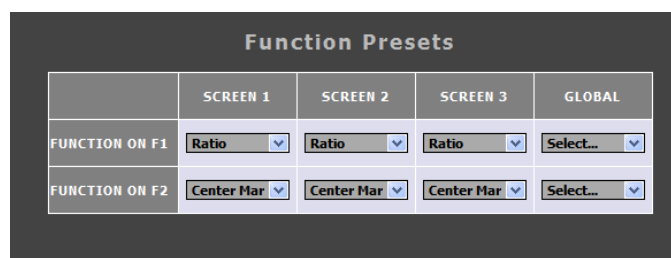

	SCREEN 1	SCREEN 2	SCREEN 3	GLOBAL
FUNCTION ON F1	Ratio	Ratio	Ratio	Select...
FUNCTION ON F2	Center Mar	Center Mar	Center Mar	Select...

■ **Function on F1 / F2**

Use these rows to select the functions set to be controlled by the F1 and F2 buttons on the physical unit or on the Network Control page. These functions can be set individually per panel or on the global scale using the GLOBAL column.

## IMD / Tally Config

IMD/Tally Configuration				
	SCREEN 1	SCREEN 2	SCREEN 3	GLOBAL
TEXT ENABLE	<input type="checkbox"/> OFF	<input type="checkbox"/> OFF	<input checked="" type="checkbox"/> ON	<input type="checkbox"/> ON <input type="checkbox"/> OFF
TEXT STRING	Marshall Monitor <input type="button" value="Set"/>	Marshall Monitor <input type="button" value="Set"/>	Marshall Monitor <input type="button" value="Set"/>	<input type="button" value="Set"/>
TEXT COLOR	Green	Green	Green	Select...
TEXT BACKGROUND	50% Safe	50% Safe	0%	Select...
TEXT ALIGNMENT	Center	Center	Center	Select...
TALLY SOURCE	HD-15	HD-15	HD-15	Select...
LED TALLY	<input checked="" type="checkbox"/> ON	<input checked="" type="checkbox"/> ON	<input checked="" type="checkbox"/> ON	<input type="checkbox"/> ON <input type="checkbox"/> OFF
ON-SCREEN TALLY	<input type="checkbox"/> OFF	<input type="checkbox"/> OFF	<input type="checkbox"/> OFF	<input type="checkbox"/> ON <input type="checkbox"/> OFF
TEXT TALLY	<input type="checkbox"/> OFF	<input type="checkbox"/> OFF	<input type="checkbox"/> OFF	<input type="checkbox"/> ON <input type="checkbox"/> OFF

### ■ Text Enable

Use this row to turn the monitor's IMD text ON or OFF. This can also be changed on the global level under the GLOBAL column.

### ■ Text String

Use the dialogue box in this row to enter a text string that will be displayed on the monitors. You may enter up to 16 characters in this dialogue box. To confirm your text entry, press the Set button below the dialogue box. Text can be entered for each individual panel or globally in the GLOBAL column.

### ■ Text Color

Use this row to change the color of the text for each individual panel, or globally under the GLOBAL column.

### ■ Text Background

Use this row to toggle between different settings for the IMD Text String's background transparency. This can be changed for each individual panel or globally in the GLOBAL column.

### ■ Text Alignment

Use this row to select the alignment of the IMD text. This can be changed individually or globally in the GLOBAL column.

### ■ Tally Source

Use this row to determine the current source for the LED tally lights on each individual panel. Use the drop down menu to select between the different tally sources. This can be changed individually or globally.

### ■ LED Tally

Use this to turn the LED Tally lights ON or OFF. This can be changed individually or globally and overrides any of the Tally Source selections.

### ■ On-Screen Tally

Use this to turn the On-Screen Tally lights ON or OFF. This can be changed individually or globally.

### ■ Text Tally

Use this to turn the Text Tally function ON or OFF. This can be changed individually or globally.

# Display Tab

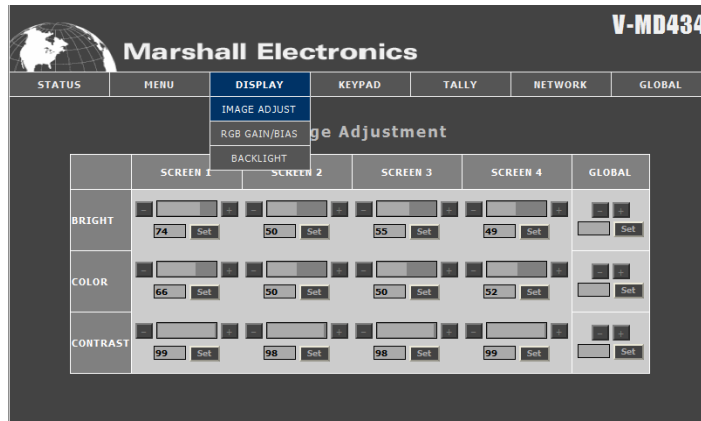

## Image Adjustment

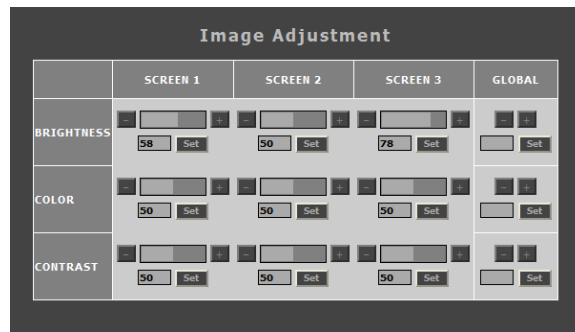

### ■ BRIGHTNESS, COLOR, CONTRAST

Use this section to adjust the Brightness, Color and Contrast of each individual panel, or to adjust these values globally. To enter a value manually, type in a number from 0-100 in the dialogue box and press Set. The value selected on this page will show up on the monitor screen in real time.

## RGB Gain / Bias

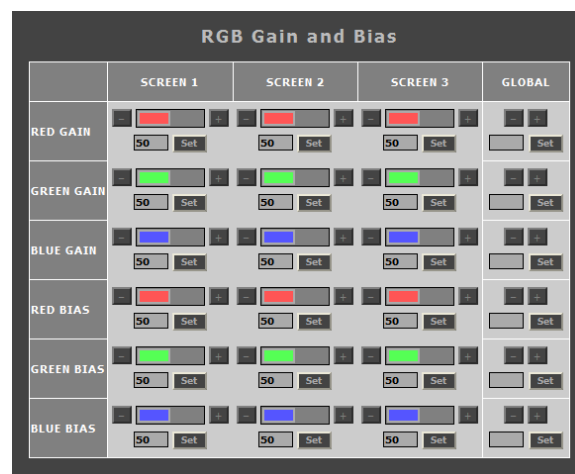

■ **RGB Gain and Bias**

Use this section to adjust the Gain and Bias for the Red, Green and Blue components of the video signal. This can be done for each individual screen or globally. To enter a value manually, type in a number from 0-100 in the dialogue box and press Set.

Backlight

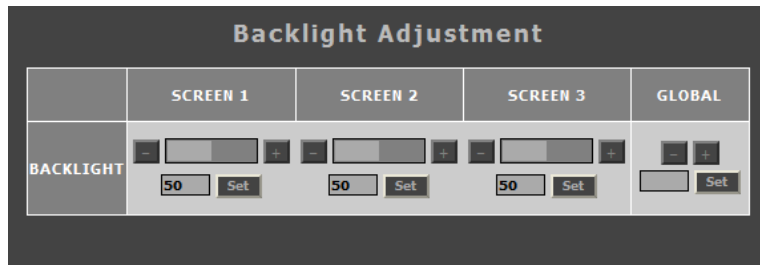

■ **Backlight**

Use this section to adjust the Backlight value for each panel. This can be done for each individual screen or globally. To enter a value manually, type in a number from 0-100 in the dialogue box and press Set.

Keypad Tab

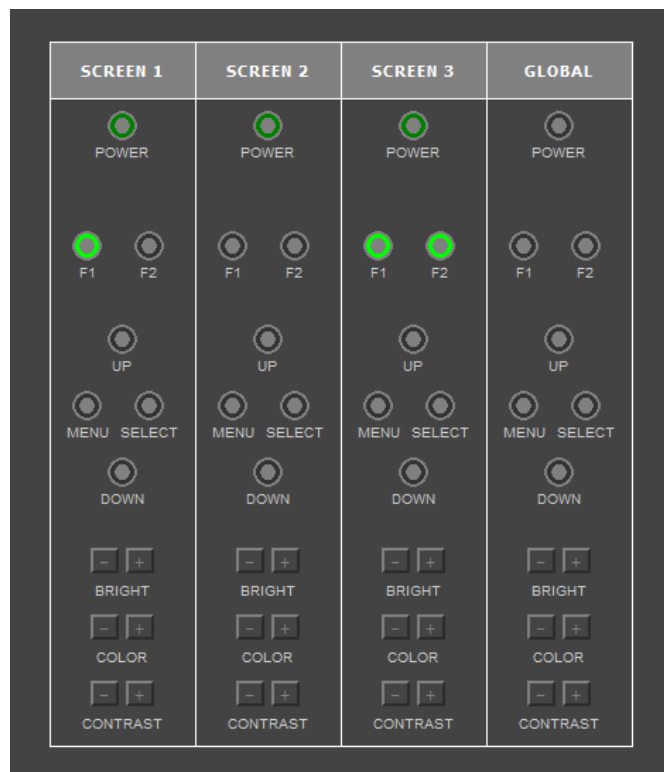

Use the keypad portion of the Network Control page to access all aspects of the physical keypad from the Network Control page. The GLOBAL column allows you to control a virtual Global Keypad that is like using all three keypads at the same time.

# Tally Tab

---

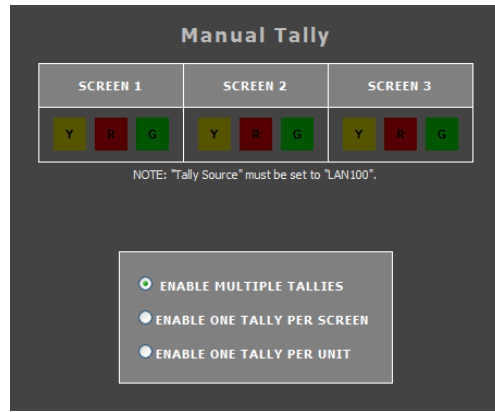

Use the Tally page, in conjunction with the LAN100 tally source, to control the LED and soft tally on the V-MD434 and V-Md503 monitors. The Tally can be controlled individually for each tally set above each panel.

The radio buttons allow for customization of tally lights to be used by the monitor. You can select between using all possible colors, one color per screen or one color per unit.

# Network Tab

---

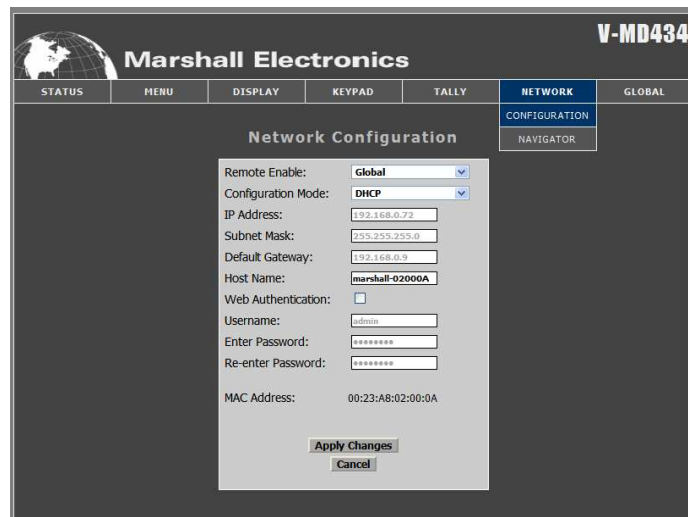

## Network Configuration

The screenshot shows a 'Network Configuration' window with the following settings:

- Remote Enable: Global
- Configuration Mode: DHCP
- IP Address: 192.168.0.78
- Subnet Mask: 255.255.255.0
- Default Gateway: 192.168.0.9
- Host Name: marshall-000B06
- Web Authentication:
- Username: admin
- Enter Password: [masked]
- Re-enter Password: [masked]
- MAC Address: 00:23:A8:00:0B:06

Buttons: Apply Changes, Cancel

### ■ Remote Enable

Select whether you would like to be able to access a particular monitor's web page or web functions from another monitor on the same network.

### ■ Configuration Mode

Use this drop down menu to select between the different IP configuration modes available for the monitor.

### ■ IP Address

If you have selected the Manual configuration mode for the IP configuration mode, you will be able to enter an IP address manually in this field. If you have selected DHCP, the box will have an IP address already entered. This is not changeable when in DHCP mode.

### ■ Subnet Mask

If you have selected the Manual configuration mode for the IP configuration mode, you will be able to enter Subnet Mask address manually in this field. If you have selected DHCP, the box will have Subnet Mask already entered. This is not changeable when in DHCP mode.

### ■ Default Gateway

If you have selected the Manual configuration mode for the IP configuration mode, you will be able to enter Default Gateway address manually in this field. If you have selected DHCP, the box will have Default Gateway already entered. This is not changeable when in DHCP mode.

### ■ Host Name

Use this field to enter a Host Name for the V-MD434 or V-MD503 monitor. You may choose up to 16 alphanumeric characters for the Host Name.

### ■ Web Authentication

Fill in the Web Authentication box to protect the V-MD434 or V-MD503 monitor from being accessed by a user without a User Name and Password. Filling this box in will enable the Username and Password fields below.

#### ■ Username



Enter a 15 alphanumeric character string Username in this field. This will only work if the Web Authentication option has been turned ON.

■ **Enter Password / Re-enter Password**

Enter a 15 alphanumeric character string Password in this field. You will need to Re-enter the password in the box below the Enter Password box for additional security.

■ **MAC Address**

This is the unique MAC address for this V-MD434 and V-MD503 monitor. This cannot be changed.

To save all changes, press the Apply Changes button. You may also cancel out of the changes you have made by pressing the Cancel button.

Navigator

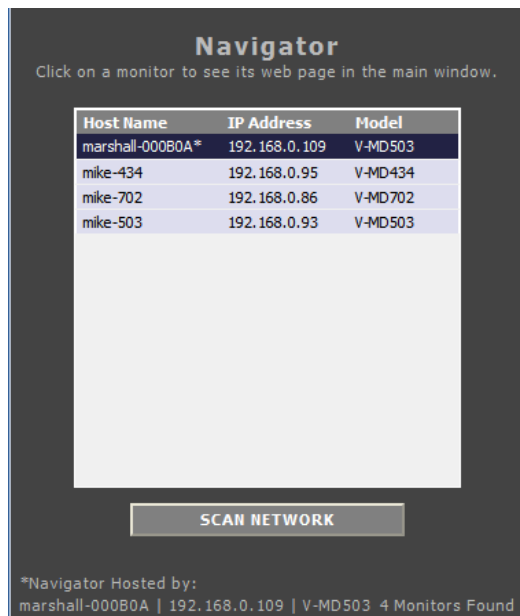

The Network Control page's Navigator allows you to scan your network for other V-MD434 or V-MD503 monitors or any other Marshall Electronics Web Enabled MD monitors. From the navigator, you can find and sort all monitors by their Host Name, IP Address or Model number. You can also access each monitor's Network Control page.

Press the Scan Network button once to scan your network for other MD monitors. The navigator will not detect any monitors added to the network if the scan was performed prior to their installation.

The information field at the bottom will indicate the Host Name, IP Address and model number of the origin of the Navigator pop up page. It will also give a count of how many monitors have been found on the network.

# Global Tab

Use the Global tab to control multiple Marshall Electronics MD monitors simultaneously. To control a monitor, highlight an MD monitor by clicking on its Host Name, IP Address or Model. Monitors being controlled will be highlighted in blue.

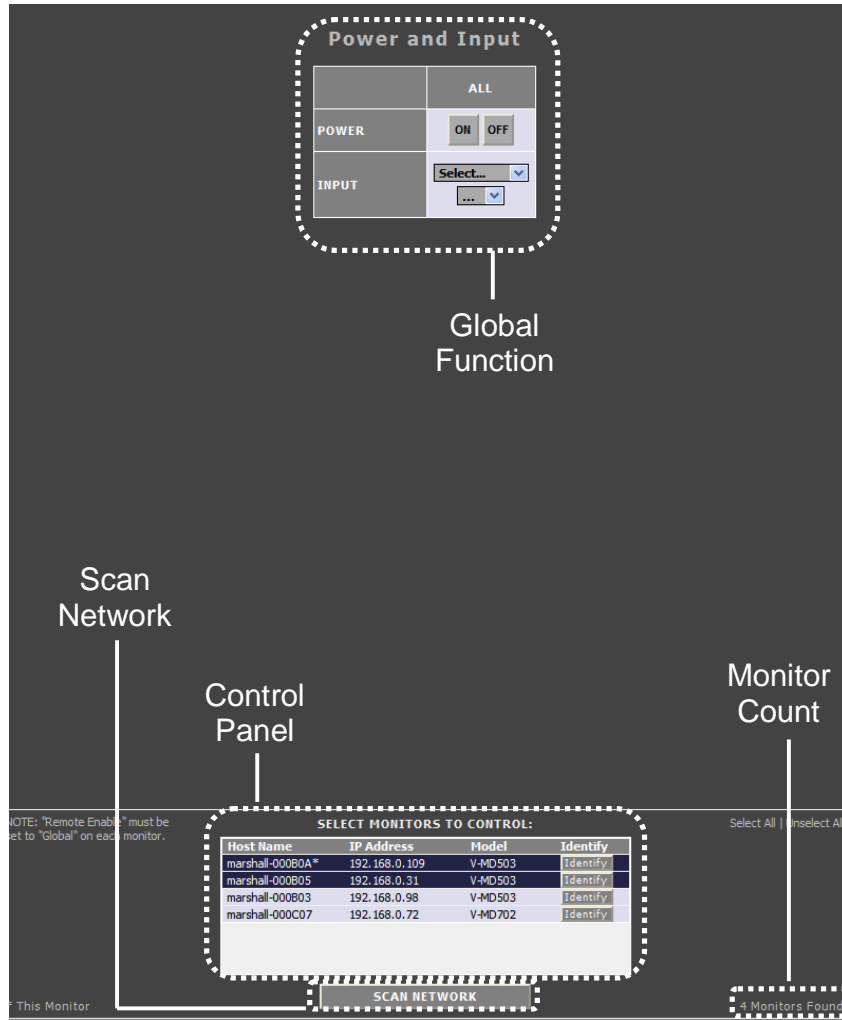

## Scan Network

Use the Scan Network button to scan for any other Marshall Electronics MD monitor connected on your network. The results will show up in the **Control Panel** box.

## Control Panel

The control panel is located in the lower portion of the screen and lists all Marshall Electronics MD monitors available on your network, along with their Host Name, IP Address and Model type. This information can also be sorted by category by pressing the Host Name, IP Address or Model bar at the top of the control panel box. The Identify button next to each monitor allows you to identify any monitor listed in the Control Panel. Pressing this button will cause the

LED Tally lights on the monitor to flash once. These lights will flash regardless of the monitor's Tally Source or LED Tally status in the IMD & Tally Configuration menu.

## Monitor Count

Use this count to quickly identify the number of Marshall Electronics MD monitors on your network.

## Global Function

The function controlled in this field is selectable through the Network Control page's GLOBAL tab on the top right. Choose between Power / Input, Image Adjust, Backlight, Video Config, Marker Config, Filter Config, System Config, Function Presets and IMD/Tally Config.

# Specifications

## ■ PANEL

### V-MD503

Screen Size	5" Diagonal
Display Area (h x v)	108.0 x 64.8 mm
Aspect Ratio	15:9 Native
Pixels	800 x RGB x 480
Color Depth	8-bit
Viewing Angle (h x v)	85° x 85°
Brightness	300 cd/m <sup>2</sup>
Contrast Ratio	600:1
Pixel Pitch (h x v)	0.135 mm x 0.135mm

### V-MD434

Screen Size	4.3" Diagonal
Display Area (h x v)	93.0 x 55.8 mm
Aspect Ratio	15:9 Native
Pixels	800 x RGB x 480
Color Depth	6-bit
Viewing Angle (h x v)	65° x 65°
Brightness	200 cd/m <sup>2</sup>
Contrast Ratio	400:1
Pixel Pitch (h x v)	0.116 mm x 0.116mm

### Burn-In Warning

The V-MD503 and V-MD434 uses a high quality TFT LCD panels. However, if a static image is left on the screen for 48 hours, there may be a 10 to 20 minute recovery period for the panel. During recovery, a very faint image may be retained on the display. Put up a white image for 30 minutes to eliminate the retained image.

## ■ Modular Inputs

Marshall Electronics Type B Input Modules

## ■ CONNECTORS

### Power Input

2-Pin Twist-Lock Connector

### Tally Hardware Interface

HD-15 Female

### RJ45 Ethernet Port

8P8C Female RJ45 Port

## ■ TALLY HARDWARE INTERFACE (HD-15)

Activation requires contact closure of pin to ground on the HD-15 connector:

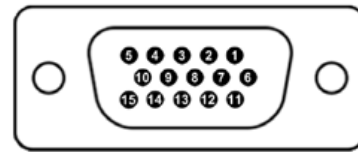

Pin	Tally
1	Panel 1 Green
2	Panel 1 Red
3	Panel 1 Yellow
4	Ground
5	Panel 4 Green
6	Panel 2 Green
7	Panel 2 Red
8	Panel 2 Yellow
9	Ground
10	Panel 4 Red
11	Panel 3 Green
12	Panel 3 Red
13	Panel 3 Yellow
14	Ground
15	Panel 4 Yellow

Note: The table above is specific to the V-MD434. For the V-MD503, pins 5, 10 and 15 are N/C (No Contact) and should not be used.

## ■ ELECTRICAL

### V-MD503

Power Consumption	21 W
Voltage Requirement	12 VDC

### V-MD434

Power Consumption	24 W
Voltage Requirement	12 VDC

### V-PS12-5V-1 Power Supply:

Input	100V-240V, 1.5A, 50-60Hz
Output	12VDC, 5A, 60W Max

## ■ MECHANICAL

### V-MD503

Dimensions (w x h x d):	19.12" x 3.4" x 1.73"
Weight (Without Modules):	2.52 lbs

### V-MD434

Dimensions (w x h x d):	19.12" x 3.4" x 1.73"
Weight (Without Modules):	2.68 lbs

### V-MD503 and V-MD434

Operating Temperature	32°F to 120°F (0°C to 40 °C)
Storage Temperature	-4°F to 120°F (-20°C to 50°C)

RoHs

Do not dispose. Return to Manufacturer or Authorized Recycle Facility.

# Dimensions

---

V-MD503

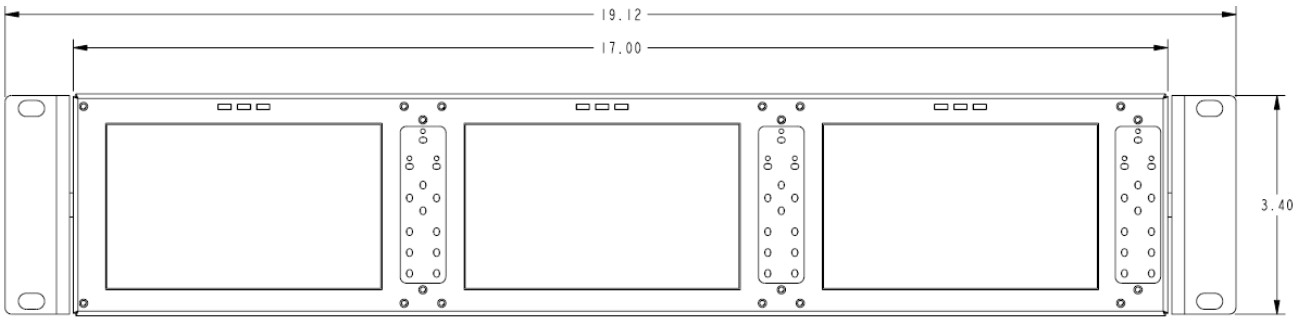
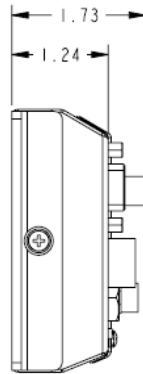

V-MD434

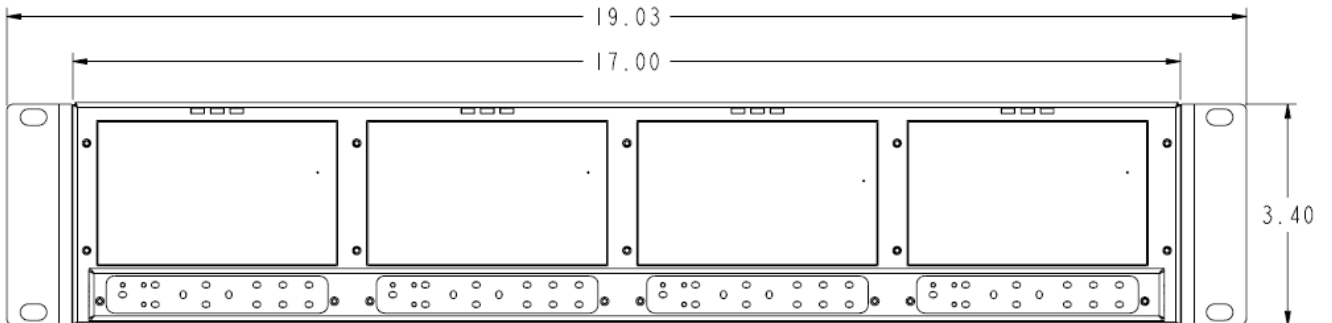
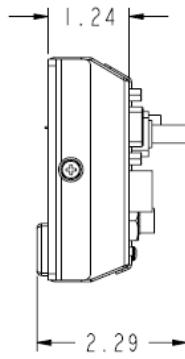

## Maintenance

---

### ■ Screen Cleaning

Periodically clean the screen surface using ammonia-free cleaning wipes (Marshall Part No. **V-HWP-K**). A clean micro-fiber cloth can also be used using only non-abrasive and ammonia-free cleaning agents. Do not use paper towels. Paper towel fibers are coarse and may scratch the surface of the polycarbonate faceplate or leave streaks on the surface. Antistatic and fingerprint resistant cleaning agents are recommended. Do not apply excessive pressure to the screen to avoid damaging the LCD.

### ■ Faceplate Dusting

Dust the unit with a soft, damp cloth or chamois. Dry or abrasive cloths may cause electrostatic charge on the surface, attracting dust particles. Neutralize static electricity effects by using the recommended cleaning and polishing practice.

## Warranty

---

Marshall Electronics warrants to the first consumer that this **V-MD503** or **V-MD434** LCD monitor will, under normal use, be free from defects in workmanship and materials, when received in its original container, for a period of one year from the purchase date. This warranty is extended to the first consumer only, and proof of purchase is necessary to honor the warranty. If there is no proof of purchase provided with a warranty claim, Marshall Electronics reserves the right not to honor the warranty set forth above. Therefore, labor and parts may be charged to the consumer. This warranty does not apply to the product exterior or cosmetics. Misuse, abnormal handling, alterations or modifications in design or construction void this warranty. *It is considered normal for a minimal amount of pixels, not to exceed three, to fail on the periphery of the display active viewing area.* Marshall Electronics reserves the option to refuse service for display pixel failure if deemed unobtrusive to effective use of the monitor by our technicians. No sales personnel of the seller or any other person is authorized to make any warranties other than those described above, or to extend the duration of any warranties on behalf of Marshall Electronics, beyond the time period described above. Due to constant effort to improve products and product features, specifications may change without notice.

**This page intentionally left blank**

**This page intentionally left blank**

**Marshall Electronics, Inc.**

1910 East Maple Ave.  
El Segundo, CA 90245

Tel: (800) 800-6608 / (310) 333-0606 • Fax: 310-333-0688  
[www.LCDRacks.com](http://www.LCDRacks.com) • [sales@lcdracks.com](mailto:sales@lcdracks.com)

2010-1122