

GXD Amplifier



User Manual

GXD 4

GXD 8

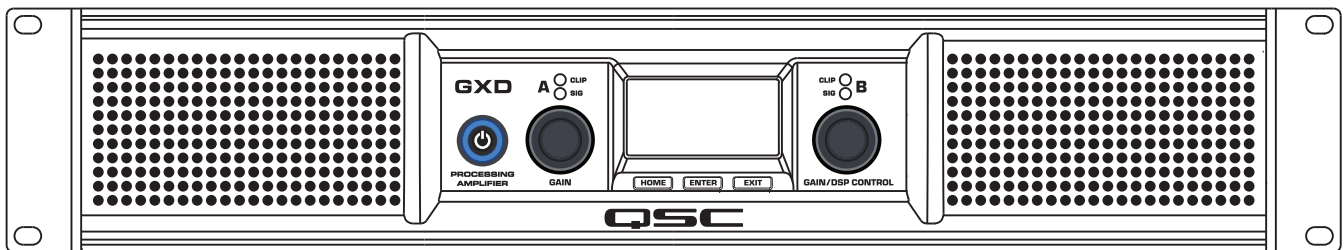

TD-000450-00-A



EXPLANATION OF SYMBOLS

The term "**WARNING!**" indicates instructions regarding personal safety. If the instructions are not followed the result may be bodily injury or death.

The term "**CAUTION!**" indicates instructions regarding possible damage to physical equipment. If these instructions are not followed, it may result in damage to the equipment that may not be covered under the warranty.

The term "**IMPORTANT!**" indicates instructions or information that are vital to the successful completion of the procedure.

The term "**NOTE**" is used to indicate additional useful information.



The intent of the lightning flash with arrowhead symbol in a triangle is to alert the user to the presence of un-insulated "dangerous" voltage within the product's enclosure that may be of sufficient magnitude to constitute a risk of electric shock to humans.



The intent of the exclamation point within an equilateral triangle is to alert the user to the presence of important safety, and operating and maintenance instructions in this manual.



IMPORTANT SAFETY INSTRUCTIONS



WARNING! TO PREVENT FIRE OR ELECTRIC SHOCK, DO NOT EXPOSE THIS EQUIPMENT TO RAIN OR MOISTURE.



EN

1. Read these instructions.
2. Keep these instructions.
3. Heed all warnings.
4. Follow all instructions.
5. Do not use this apparatus near water.
6. Do not submerge the apparatus in water or liquids.
7. Do not use any aerosol spray, cleaner, disinfectant or fumigant on, near or into the apparatus.
8. Clean only with a dry cloth.
9. Do not block any ventilation opening. Install in accordance with the manufacturer's instructions.
10. Keep ventilation opening free of dust or other matter.
11. Do not install near any heat sources such as radiators, heat registers, stoves, or other apparatus (including amplifiers) that produce heat.
12. To reduce the risk of electrical shock, the power cord shall be connected to a mains socket outlet with a protective earthing connection.
13. Do not defeat the safety purpose of the polarized or grounding-type plug. A polarized plug has two blades with one wider than the other. A grounding type plug has two blades and a third grounding prong. The wide blade or the third prong are provided for your safety. If the provided plug does not fit into your outlet, consult an electrician for replacement of the obsolete outlet.
14. Protect the power cord from being walked on or pinched particularly at plugs, convenience receptacles, and the point where they exit from the apparatus.
15. Do not unplug the unit by pulling on the cord, use the plug.
16. Only use attachments/accessories specified by the manufacturer.
17. Unplug this apparatus during lightning storms or when unused for long periods of time.
18. Refer all servicing to qualified service personnel. Servicing is required when the apparatus has been damaged in any way, such as power-supply cord or plug is damaged, liquid has been spilled or objects have fallen into the apparatus, the apparatus has been exposed to rain or moisture, does not operate normally, or has been dropped.
19. The appliance coupler, or the AC Mains plug, is the AC mains disconnect device and shall remain readily operable after installation.
20. Adhere to all applicable, local codes.
21. Consult a licensed, professional engineer when any doubt or questions arise regarding a physical equipment installation.

Maintenance and Repair



WARNING! Advanced technology, e.g., the use of modern materials and powerful electronics, requires specially adapted maintenance and repair methods. To avoid a danger of subsequent damage to the apparatus, injuries to persons and/or the creation of additional safety hazards, all maintenance or repair work on the apparatus should be performed only by a QSC authorized service station or an authorized QSC International Distributor. QSC is not responsible for any injury, harm or related damages arising from any failure of the customer, owner or user of the apparatus to facilitate those repairs.

FCC Statement



NOTE: This equipment has been tested and found to comply with the limits for a Class B digital device, pursuant to Part 15 of the FCC Rules.

These limits are designed to provide reasonable protection against harmful interference in a residential installation. This equipment generates, uses and can radiate radio frequency energy and, if not installed and used in accordance with the instructions, may cause harmful interference to radio communications. However, there is no guarantee that interference will not occur in a particular installation. If this equipment does cause harmful interference to radio or television reception, which can be determined by turning the equipment off and on, the user is encouraged to try to correct the interference by one or more of the following measures:

- Reorient or relocate the receiving antenna.
- Increase the separation between the equipment and receiver.
- Connect the equipment into an outlet on a circuit different from that to which the receiver is connected.
- Consult the dealer or an experienced radio/TV technician for help.

Warranty

For a copy of the QSC Limited Warranty, visit the QSC Audio Products website at www.qsc.com

Introduction

The GXD Class-D amplifiers have been engineered for high performance output and optimized for maximum real-world headroom into 4Ω and 8Ω loudspeaker systems. The power levels of the GXD amplifiers are matched to the most popular loudspeakers:

- GXD 4, per channel – 400 W into 8Ω, and 600 W into 4Ω (1600 W peak)
- GXD 8, per channel – 800 W into 8Ω, and 1200 W into 4Ω (4500 W peak)

The Class-D amplifier topology is very efficient, making the GXD amplifiers small and light. In addition the Universal Power Supply used in the GXD helps to reduce weight. Both amplifiers are 2RU and are only 229 mm (9 inches) deep. The GXD 4 weighs in at 5 kg (11 lbs), the GXD 8 is at 5.9 kg (13 lbs).

The GXD amplifiers have an LCD for control and monitoring, with three buttons for menu navigation, and two knobs for adjusting parameters. There are 20 User Presets that can be edited, stored and recalled to match any configuration or system

Each channel has parallel XLR and 1/4" TRS connectors for inputs. The outputs are professional NL4 and binding post connectors for mono and bi-amp speaker connectivity. You can keep your amplifier up-to-date with software updates using the USB connector.

Both amplifiers have complete loudspeaker processing:

- Channel Gain & Polarity
- 4th Order Linkwitz Riley Highpass and Lowpass Filters
- 4-band Parametric EQ
- 50 mSec of Alignment Delay
- QSC Power Limiting

EN

Package Contents

1. Quick-Start Guide TD-000449-00
2. GXD Amplifier
3. IEC AC Power Cord
4. USB Cable

Rack-Mount the Amplifier

The GXD Series amplifiers are designed to be mounted in a standard rack-mount unit. The amplifiers are 2RU high, and 229 mm (9 in) deep.

1. Secure the amplifier in the rack with four screws (not included).



CAUTION! Be sure that nothing is blocking the front or rear ventilation openings, and that each side has a minimum of 2 cm clearance.

Features

Amplifier Front Panel

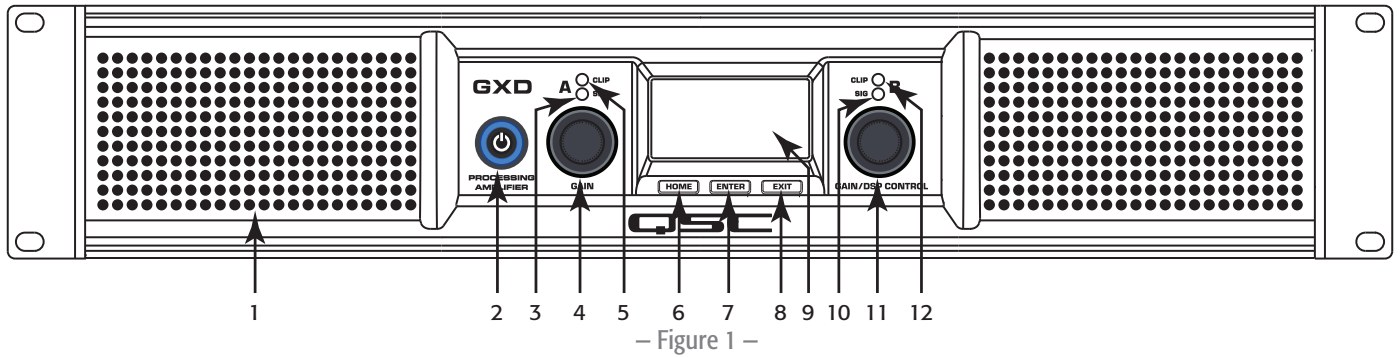

- | | | |
|-------------------------------------|-------------------------|---|
| 1. Air Vents | 5. Channel A CLIP (red) | 9. LCD Screen |
| 2. Power Button | 6. HOME Button | 10. Channel B Signal Present (green) |
| 3. Channel A Signal Present (green) | 7. ENTER Button | 11. Channel B GAIN and function selection |
| 4. Channel A GAIN | 8. EXIT Button | 12. Channel B CLIP (red) |

EN

Amplifier Rear Panel (Figure 2 GXD 4, Figure 3 GXD 8)

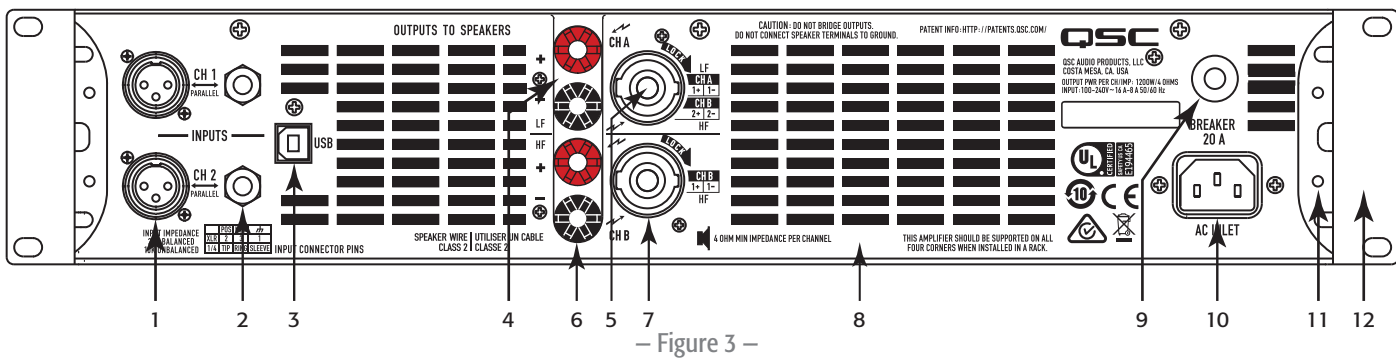
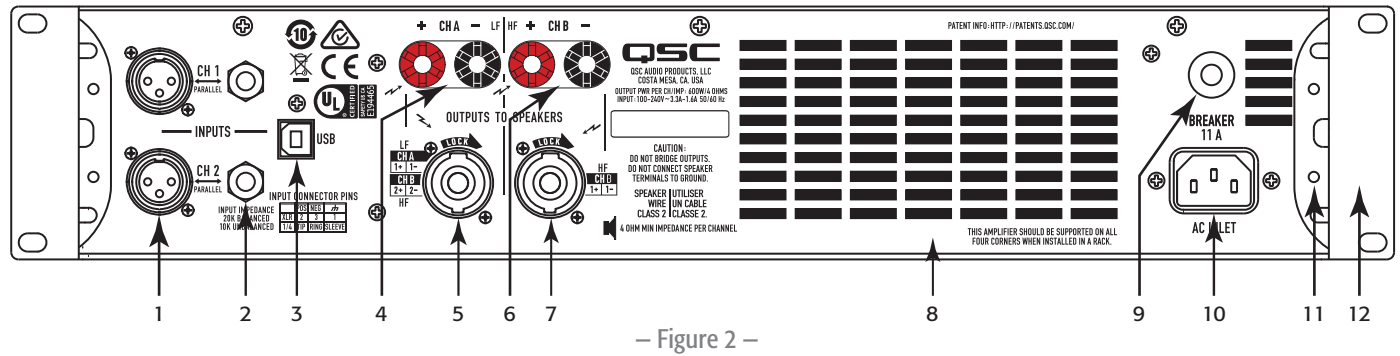

- | | | |
|--|-----------------------------------|---|
| 1. Channel 1 and Channel 2 Input XLRs (female) | 5. Channel A Output NL4 Connector | 9. Circuit Breaker (GXD 4–11 A, GXD 8–20 A) |
| 2. Channel 1 and Channel 2 Input TRS female | 6. Channel B Output Binding Posts | 10. Locking IEC Power Connection |
| 3. USB Connector | 7. Channel B Output NL4 Connector | 11. Rear Rack-mount Bracket |
| 4. Channel A Output Binding Posts | 8. Air Vents | 12. Front Rack-mount Brackets |

Connections

Inputs (Channels 1 & 2)

See Figure 4

Input Impedance: 20k ohms Balanced, 10k ohms Unbalanced See Table 1 for wiring.

1. XLR female
2. 1/4" female TRS Phone Jack
3. USB Standard B connector - Used for updating the amplifier firmware, refer to the GXD User Manual for details.

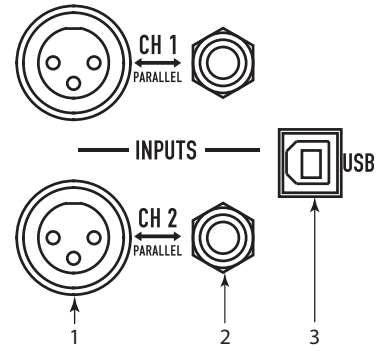

– Figure 4 –

Outputs (Channels A & B)

See Figure 5

4Ω or 8Ω impedance



CAUTION! Do not combine the audio outputs in any way. Do not connect the audio outputs to ground.

Input Wiring

Connector	POS	NEG	GROUND
XLR	2	3	1
1/4"	TIP	RING	SLEEVE

– Table 1 –

Wiring Be sure to observe polarity.

- NL4 connector – See Figure 6
- Binding Posts - Use banana plugs or wire directly.

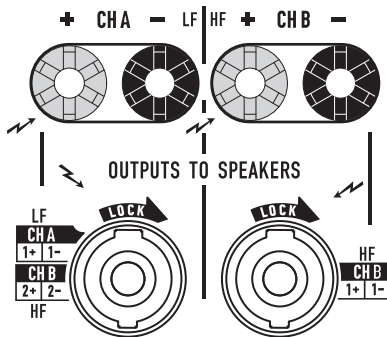

GXD 4 Outputs

– Figure 5 –

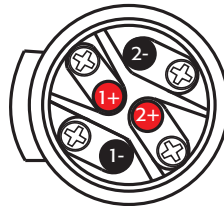

Male NL4 Wiring

– Figure 6 –

Power Output

Amplifier	8 Ω	4 Ω	Total
GXD 4	400 W	600 W	1200 W
GXD 8	800 W	1200 W	2400 W

– Table 2 –

AC Power



WARNING! The power cord shall be connected to a mains socket outlet with a protective earthing connection.

See Figure 7

Connect the IEC power cord to the AC receptacle on the rear of the amplifier.

Push to reset Breaker when necessary.

Power Consumption

Amplifier	Voltage	Current	Frequency
GXD 4	100–240 VAC	~3.3 A–1.6 A	50/60 Hz
GXD 8	100–240 VAC	~6.3 A–3.1 A	50/60 Hz

– Table 3 –

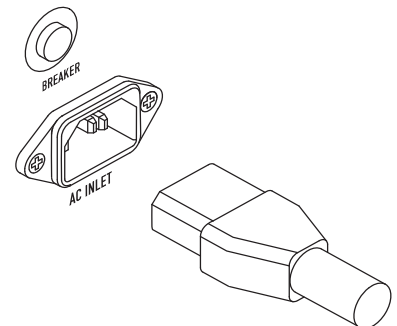

– Figure 7 –

Controls

See Figure 8

1. Channel A CLIP indicator – illuminates red when the input is high enough to cause the channel to clip.
2. Channel A SIG (signal) present indicator – illuminates green when there is a signal applied to the input.
3. Power Switch/LED on/off – Illuminates blue when on.
4. Adjust Channel A GAIN
5. User Interface

- a. **HOME** – go to HOME screen / view current PRESET
 - b. **ENTER** – select highlighted item and/or confirm parameter change
 - c. **EXIT** – return to previous screen and/or undo parameter change
6. Adjust Channel B GAIN, selects and adjusts controls
 7. Channel B SIG (signal) presence indicator – illuminates green when there is a signal applied to the input.
 8. Channel B CLIP indicator – illuminates red when the input is high enough to cause the channel to clip.

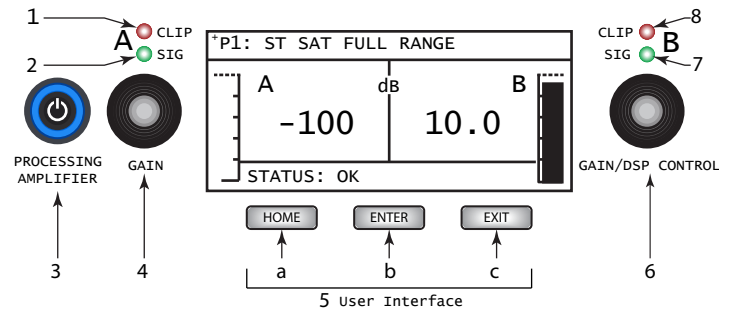

– Figure 8 –

EN

GXD Signal Flow

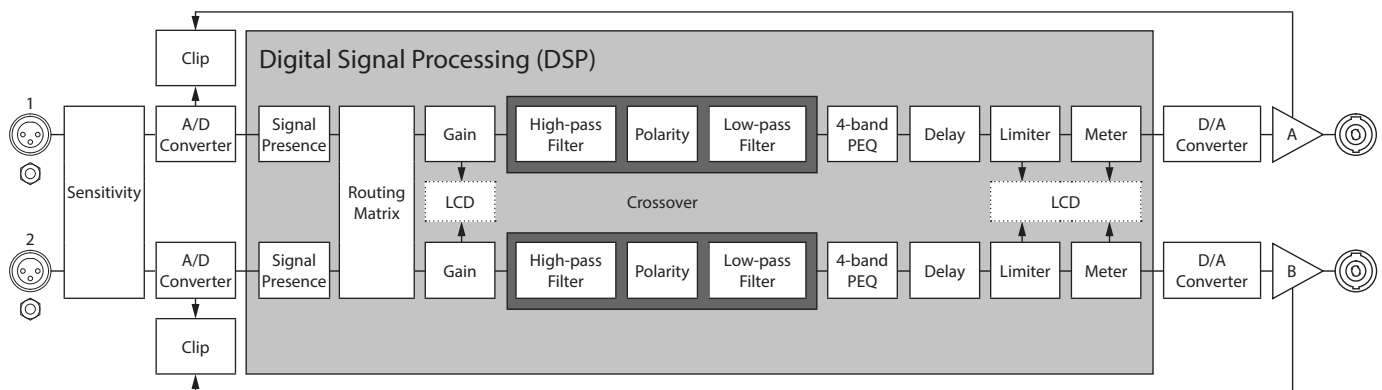

– Figure 9 –

Setup and Operation

Menu Tree

PRESET

- PRESET RECALL
- PRESET SAVE
- PRESET SAVE AS

* STEREO DSP and DSP A / DSP B depend on the selected configuration.

STEREO DSP*

- SENSITIVITY
- CROSSOVER
- EQ
- DELAY
- LIMITER

DSP A / DSP B*

- SENSITIVITY
- CROSSOVER
- EQ
- DELAY
- LIMITER

UTILITIES

- STATUS
- CONTRAST
- TIMEOUT
- LOCKOUT
- RESET

– Figure 10 –

Navigation Key

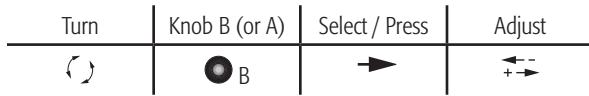

Home Screen

See Figure 11

From any screen → 

1. Asterisk (*) indicating an unsaved change to the preset
2. Currently active preset location (P1) and name
3. Output channel letter A and B
4. Limiter level indicator (Channels A and B)
5. LIMIT and CLIP indicators
6. Output meter A and B (visual)
7. Output gain (digital) range = -100 to +10 dB (Channels A and B)
8. Amplifier STATUS

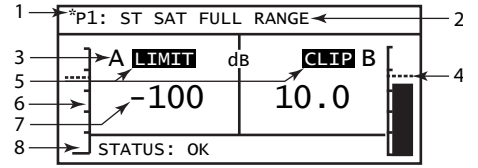

– Figure 11 –

EN

Main Navigation Menu

See Figure 12

From HOME → 

1. Previous selection – PRESETS
2. Currently selected – STEREO DSP (or DSP A and DSP B)
3. Next selection – UTILITIES
4. Instructions

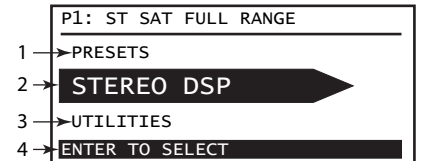

– Figure 12 –

Configurations

There are four basic types of configuration selected by presets:

- Figure 13 – 2 channels in, stereo DSP, 2 channels out – Channel controls are linked, audio signals are not combined. (P1 through P7)
- Figure 14 – 2 channels in, separate DSP, 2 channels out – Channel controls are not linked except sensitivity. (P8 through P10)
- Figure 15 – 1 or 2 channels in, separate DSP, 2 channels out – Channel controls are not linked except sensitivity. (P11 through P18)
- Figure 16 – 1 or 2 channels in, stereo DSP, 2 channels out – Channel controls are linked, audio signals are combined. (P19 and P20)

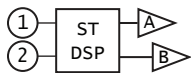

– Figure 13 –

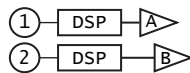

– Figure 14 –

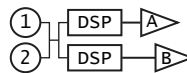

– Figure 15 –

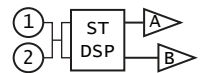

– Figure 16 –

For ST (stereo) DSP presets, the DSP functionality (Crossover, PEQ, Delay, Limiter) controls are linked. Sensitivity is always linked.

PRESET

A preset configures the inputs and outputs, along with setting the DSP. When you make changes to the DSP, you can save your setup in any of the 20 preset locations. Refer to "Preset Defaults" on page 12 for the preset factory defaults.

View Current Preset Configuration

From HOME → 

To return → 

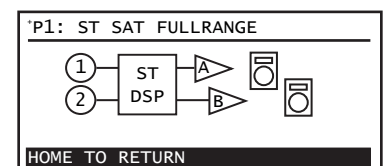

– Figure 17 –

PRESET RECALL

Recall a preset to configure the amplifier to meet the requirements of your loudspeakers and installation. There are 20 Presets. See Figure 18

1. From HOME → **ENTER**
2. **⏪** **B** → PRESET, → **ENTER**
3. **⏪** **B** → PRESET RECALL, → **ENTER**
4. **⏪** **B** → the preset you want, → **ENTER** **ENTER**

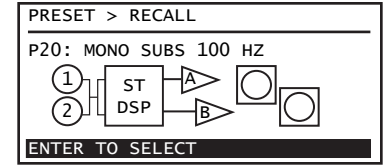

– Figure 18 –

PRESET SAVE

Saves the active preset with any DSP changes. See Figure 19

1. From HOME **ENTER**
2. **⏪** **B** → PRESET, → **ENTER**
3. **⏪** **B** → PRESET SAVE, → **ENTER** **ENTER**



– Figure 19 –

PRESET SAVE AS

Select the LOCATION and/or change the NAME to save changes you make to the DSP. See Figure 20 and Figure 21

1. From HOME **ENTER**
2. **⏪** **B** → PRESET, → **ENTER**
3. **⏪** **B** → PRESET SAVE AS, → **ENTER**
4. **⏪** **B** → LOCATION → **ENTER**
5. **⏪** **B** → the LOCATION (P1 to P20), → **ENTER**
6. **⏪** **B** → NAME, → **ENTER**
7. **⏪** **B** → letter, number, hyphen, or space → **ENTER** repeat. When finished → **EXIT**
8. **B** SAVE, → **ENTER** **ENTER**

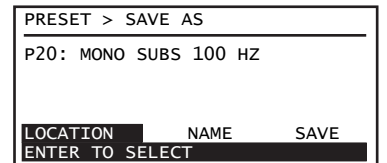

– Figure 20 –

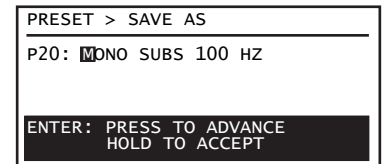

– Figure 21 –

STEREO DSP or DSP A and DSP B

STEREO DSP is set for both channels equally, at the same time. Separate DSPs (DSP A and DSP B) are set independently for each channel. Any changes you make are made in real time – you hear the change as it is being made.



NOTE: The term "STEREO DSP" is used in this document as a generic term to mean either STEREO DSP or DSP A/DSP B, unless specifically noted.

SENSITIVITY

See Figure 22 through Figure 24

1. From HOME → **ENTER**
2. **⏪** **B** → STEREO DSP, → **ENTER**
3. **⏪** **B** → SENSITIVITY, → **ENTER**
4. **⏪** **B** → 1.2V (+4 dBu) or 3.9V (+14 dBu), TOUCHMIX, → **ENTER**

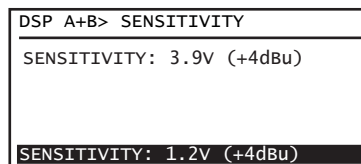

– Figure 22 –

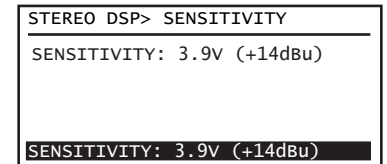

– Figure 23 –

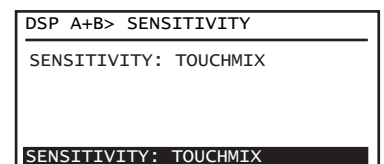

– Figure 24 –

CROSSOVER AND POLARITY

See Figure 25 through Figure 27.

1. From HOME → **ENTER**
2. **⏪** **B** → STEREO DSP, → **ENTER**
3. **⏪** **B** → CROSSOVER, → **ENTER**
4. **⏪** **B** → HPF, → **ENTER**
5. **⏪** **B** ↔ FREQUENCY (BYPASS, 20 Hz to 4 kHz), → **ENTER**
6. **⏪** **B** → LPF, → **ENTER**
7. **⏪** **B** ↔ FREQUENCY (BYPASS, 60 Hz to 4 kHz), → **ENTER**
8. **⏪** **B** → POL, → **ENTER**
9. **⏪** **B** → positive (+) or negative (-), → **ENTER** **HOME**

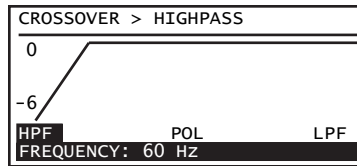

– Figure 25 –

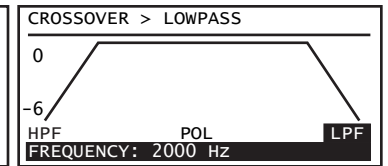

– Figure 26 –

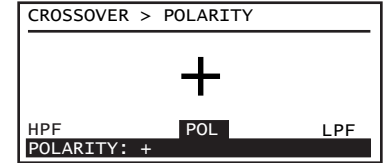

– Figure 27 –

EQ

See Figure 28 through Figure 30.

1. From HOME → **ENTER**
2. **⏪** **B** → STEREO DSP → **ENTER**
3. **⏪** **B** → EQ → **ENTER**
4. **⏪** **B** → BAND1, BAND2, BAND3, or BAND4 → **ENTER**
5. **⏪** **B** → GAIN, → **ENTER**
6. **⏪** **B** ↔ GAIN (-12 dB to +12 dB), → **ENTER**
7. **⏪** **B** → FREQUENCY, → **ENTER**
8. **⏪** **B** ↔ FREQUENCY (20 Hz to 20 kHz), → **ENTER**
9. **⏪** **B** → BW (bandwidth), → **ENTER**
10. **⏪** **B** ↔ BANDWIDTH (0.1 Oct to 3.0 Oct), → **ENTER** **HOME**

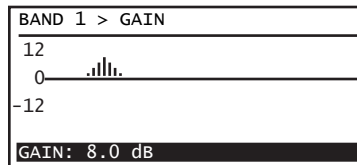

– Figure 28 –

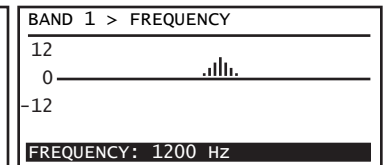

– Figure 29 –

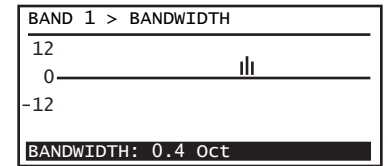

– Figure 30 –

DELAY

See Figure 31

1. From HOME → **ENTER**
2. **⏪** **B** → STEREO DSP, → **ENTER**
3. **⏪** **B** → DELAY, → **ENTER**
4. **⏪** **B** ↔ DELAY (0.00 to 56.30 FT, or 17.16 M, or 50 MS), → **ENTER** **HOME**

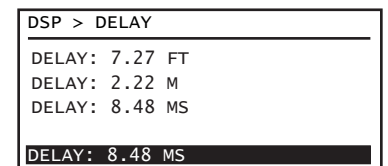

– Figure 31 –

Limiter

See Figure 32

1. From HOME → **ENTER**
2. **⏪** **B** → STEREO DSP, → **ENTER**
3. **⏪** **B** → LIMITER, → **ENTER**
4. **⏪** **B** → TYPE, → **ENTER**
5. **⏪** **B** → MILD, MEDIUM, or AGGRESSIVE → **ENTER**
6. **⏪** **B** → POWER, → **ENTER**
7. **⏪** **B** ↔ POWER (see Table 4), → **ENTER**
8. **⏪** **B** → IMPEDANCE (4Ω or 8Ω), → **ENTER** **HOME**

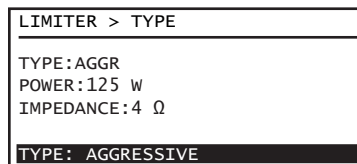

– Figure 32 –

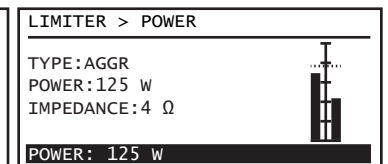

– Figure 33 –

Model	4Ω	8Ω
GXD 4	5 W – 600 W	5 W – 400 W
GXD 8	5 W – 1200 W	5 W – 800 W

– Table 4 –

Utilities

Status

See Figure 34

1. From HOME, → **ENTER**
2. **↻** ● B → UTILITIES, → **ENTER**
3. **↻** ● B → STATUS → **ENTER**
 - a. AMP TOTAL RUN TIME - Hours (HH:MM:SS)
 - b. HARDWARE - the version of the hardware unit
 - c. FIRMWARE - the version of the firmware installed on the amplifier
4. When finished, → **HOME**

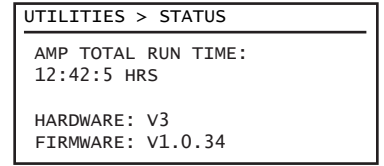

– Figure 34 –

Contrast

See Figure 35

1. From HOME, → **ENTER**
2. **↻** ● B → UTILITIES, → **ENTER**
3. **↻** ● B → CONTRAST → **ENTER**
4. **↻** ● B ⇄ CONTRAST (0 to 10) → **ENTER** **HOME**

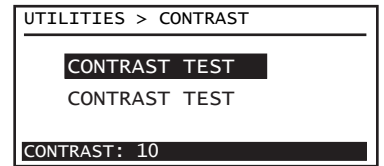

– Figure 35 –

Timeout

See Figure 36

1. From HOME, → **ENTER**
2. **↻** ● B → UTILITIES, → **ENTER**
3. **↻** ● B → TIMEOUT → **ENTER**
4. **↻** ● B ⇄ TIMEOUT (NEVER, 5 MINUTES, 1 MINUTE, or 30 SECONDS) → **ENTER** **HOME**

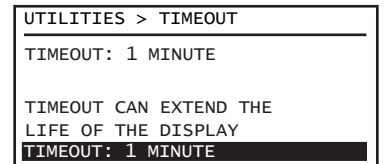

– Figure 36 –

Lockout

See Figure 37 through Figure 39

1. From HOME, → **ENTER**
2. **↻** ● B → UTILITIES, → **ENTER**
3. **↻** ● B → LOCKOUT → **ENTER**
4. **↻** ● B → UNLOCK, LOCK DSP, or LOCK ALL → **ENTER**
5. **↻** ● B → UNLOCK, LOCK DSP, or LOCK ALL → **ENTER** **HOME**

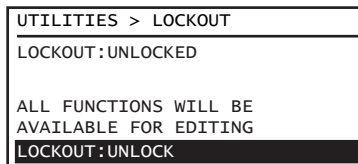

– Figure 37 –

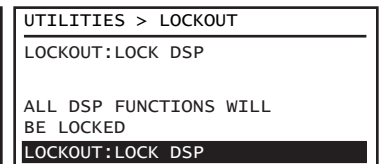

– Figure 38 –

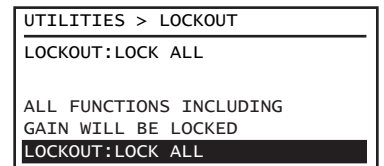

– Figure 39 –

Reset

See Figure 40 through Figure 41

1. From HOME, → **ENTER**
2. **↻** ● B → UTILITIES, → **ENTER**
3. **↻** ● B → RESET → **ENTER**
4. **↻** ● B → FACTORY RESET → **ENTER** → **ENTER**

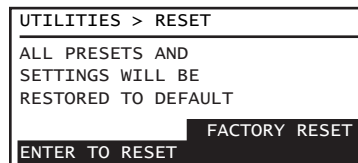

– Figure 40 –

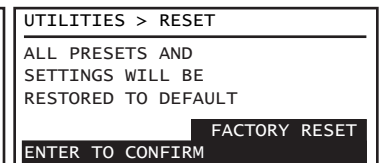

– Figure 41 –

EN

Preset Defaults

The following settings apply to all factory presets.

Sensitivity: 1.2V (+4dBu)

Crossover: POLARITY +

EQ Band 1: GAIN 0.0 dB, FREQUENCY 100 Hz, BANDWIDTH 1.0 OCT

EQ Band 2: GAIN 0.0 dB, FREQUENCY 500 Hz, BANDWIDTH 1.0 OCT

EQ Band 3: GAIN 0.0 dB, FREQUENCY 1000 Hz, BANDWIDTH 1.0 OCT

EQ Band 4: GAIN 0.0 dB, FREQUENCY 5000 Hz, BANDWIDTH 1.0 OCT

Delay: 0.00 MS, M, FT (milliseconds, meters, and feet)

Limiter: TYPE MEDIUM, POWER 800 W (400 W), IMP 8Ω

Table 5 lists the unique factory default settings for each preset.

Preset	DSP Type	Loudspeaker Type	High-Pass Filter	Low-Pass Filter	Configuration
P1	Stereo	Full Range Satellite	20 Hz	Bypass	P1–P4: ST SAT
P2	Stereo	Full Range Satellite	80 Hz	Bypass	
P3	Stereo	Full Range Satellite	90 Hz	Bypass	
P4	Stereo	Full Range Satellite	100 Hz	Bypass	
P5	Stereo	Subwoofer	20 Hz	80 Hz	P5–P7: ST SUB
P6	Stereo	Subwoofer	20 Hz	90 Hz	
P7	Stereo	Subwoofer	20 Hz	100 Hz	
P8	DSP A	Monitor	60 Hz	Bypass	P8–P10: MONITORS
P9	DSP B	Monitor	60 Hz	Bypass	
P9	DSP A	Monitor	80 Hz	Bypass	
P9	DSP B	Monitor	80 Hz	Bypass	
P10	DSP A	Monitor	100 Hz	Bypass	
P10	DSP B	Monitor	100 Hz	Bypass	
P11	DSP A	Subwoofer	20 Hz	80 Hz	P11–P13: SUB SAT
P12	DSP B	Full Range Satellite	80 Hz	Bypass	
P12	DSP A	Subwoofer	20 Hz	90 Hz	
P12	DSP B	Full Range Satellite	90 Hz	Bypass	
P13	DSP A	Subwoofer	20 Hz	100 Hz	
P13	DSP B	Full Range Satellite	100 Hz	Bypass	
P14	DSP A	Biamp	20 Hz	1000 Hz	P14–P18: BIAMP
P15	DSP B	Biamp	1000 Hz	Bypass	
P15	DSP A	Biamp	20 Hz	1100 Hz	
P15	DSP B	Biamp	1100 Hz	Bypass	
P16	DSP A	Biamp	20 Hz	1200 Hz	
P16	DSP B	Biamp	1200 Hz	Bypass	
P17	DSP A	Biamp	20 Hz	1300 Hz	
P17	DSP B	Biamp	1300 Hz	Bypass	
P18	DSP A	Biamp	20 Hz	1500 Hz	
P18	DSP B	Biamp	1500 Hz	Bypass	
P19	Stereo	Mono Full Range Satellites	50 Hz	Bypass	P19–P20: MONO SATS
P20	Stereo	Mono Full Range Satellites	100 Hz	Bypass	

– Table 5 –

Specifications

	GXD 4	GXD 8
Stereo Mode - watts per channel		
8Ω dynamic, both channels driven	600 watts	1500 watts
4Ω dynamic, both channels driven	800 watts	2250 watts
8Ω continuous, both channels driven	400 watts	800 watts
4Ω continuous, both channels driven	600 watts	1200 watts
Distortion (typical)		
1 kHz at full rated power	< 1% THD	
Signal to Noise (A-weighted, 20 Hz – 20 kHz)	100 dB	
Input Sensitivity	1.2 Vrms, 3.9 Vrms	
Voltage Gain (8Ω)	33.5 dB	36.5 dB
Output Circuitry	Class D	Class D
Power Requirements: 1/8 power at 4Ω		
- 100 Vac	3.4 Amps	6.2 Amps
- 120 Vac	2.9 Amps	5.6 Amps
- 230 Vac	1.6 Amps	3.2 Amps
Frequency Response (20 Hz – 20 kHz)	+0.7 dB, -0.8 dB	
Dynamic Headroom (4Ω)	1.25 dB	2.73 dB
Damping Factor	100	
Input Impedance (Ω)	20k (balanced), 10k (unbalanced)	
Maximum Input Level	+23.5 dBu	
Input Connectors (each channel)	3-pin XLR/F / 1/4" TRS, balanced	
Output Connectors (each channel)	NL4 (Channel 1 - 1+/-, Channel 2 - 2+/-), binding posts	
Amplifier and Load Protection	Short circuit, open circuit, thermal, RF protection Load protected against DC faults	
Front Panel Controls and Indicators	2 x Rotary Encoders 3 x Operational buttons (HOME, ENTER, EXIT) 2 x Green Signal LEDs, indicate signal presence 2 x Red A/D Clip LEDs, indicate input over-drive and/or amplifier current clipping Blue Power LED ring, AC on 2.12" x 1.0", 256 x 128 pixel LCD	
DSP Functions	High Pass Filter, 4th order LR, adjustable Frequency 20 Hz to 4 kHz Low Pass Filter, 4th order LR, adjustable Frequency 60 Hz to 4 kHz 4-band PEQ, with variable Frequency, Gain, and Bandwidth Peak Limiter, with Power, Aggressiveness, and Impedance selection Delay 50 msec max.	
Dimensions (HWD)	89 mm (2 RU) x 483 mm x 259 mm (3.5" x 19" x 10.2")	
Weight - Net	5.1 kg (11.3 lb)	6.0 kg (13.2 lb)
Weight - Shipping	7.0 kg (15.4 lb)	7.8 kg (17.3 lb)
Agency Approvals	UL, CE, RoHS/WEEE compliant	

EN



Mailing Address:

QSC Audio Products, LLC
1675 MacArthur Boulevard
Costa Mesa, CA 92626-1468 USA

Telephone Numbers:

Main Number: (714) 754-6175
Sales & Marketing: (714) 957-7100 or toll free (USA only) (800) 854-4079
Customer Service: (714) 957-7150 or toll free (USA only) (800) 772-2834

Facsimile Numbers:

Sales & Marketing FAX: (714) 754-6174
Customer Service FAX: (714) 754-6173

World Wide Web:

www.qsc.com

E-mail:

info@qsc.com
service@qsc.com
tech_support@qsc.com

EN