

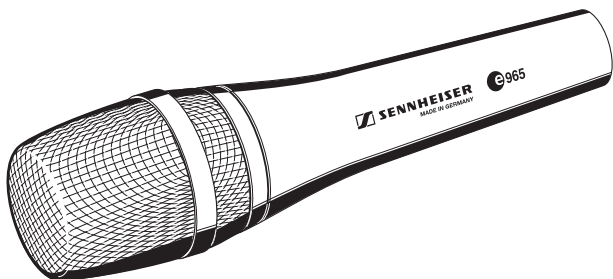

Bedienungsanleitung
Instruction Manual
Notice d'emploi
Istruzioni per l'uso
Instrucciones de uso
Gebruiksaanwijzing



Contents

Safety information	2
Delivery includes	3
The e965 microphone	4
Connecting the microphone	6
Using the microphone.....	7
Unscrewing the sound inlet basket	7
Adjusting the pick-up pattern (cardioid/super-cardioid)	8
Adjusting the sensitivity	9
Switching the low-cut filter on/off	10
Positioning the microphone	11
Overview of microphone applications	12
Care and maintenance	14
Specifications.....	15
Polar diagrams and frequency response curves	16
Manufacturer Declarations	18

Thank you for choosing Sennheiser!

We have designed this product to give you reliable operation over many years. Over 60 years of accumulated expertise in the design and manufacture of high-quality electro-acoustic equipment have made Sennheiser a world-leading company in this field.

Please take a few moments to read these instructions carefully, as we want you to enjoy your new Sennheiser products quickly and to the fullest.

Safety information

- ▶ Please read this instruction manual carefully and completely before using the microphone.
- ▶ Make this instruction manual easily accessible to all users at all times.
- ▶ Always include this instruction manual when passing the microphone on to third parties.

Intended use of the microphone

Intended use includes:

- having read and understood this instruction manual, especially the chapter “Safety information”,
- using the microphone within the operating conditions and limitations described in this instruction manual.
- using the microphone with care and storing it in a clean, dust-free environment.
- not exposing the microphone to extreme temperatures.
- protecting the microphone from humidity. Water entering the housing of the microphone can cause a short-circuit and damage the electronics. Use only a slightly damp cloth to clean the microphone.

Never opening the microphone. If devices are opened by customers in breach of this instruction, the warranty becomes null and void.

“Improper use” means using the microphone other than as described in these instructions, or under operating conditions which differ from those described herein.

Delivery includes

- 1 e965 microphone
- 1 MZQ 800 microphone clamp
- 1 Pouch
- 1 Instruction manual
- 1 Warranty certificate

The e965 microphone

The e965 is a fully professional true condenser vocal microphone utilising the very best in condenser microphone technology to achieve new standards of quality and sound. An extended dynamic range and a super-smooth frequency response deliver an outstanding signal quality with excellent vocal projection and the lowest possible distortion. The switchable pick-up pattern provides excellent flexibility and enables the e965 to handle the highest vocal levels without feedback.

The rugged metal construction protects the microphone in the most rigorous conditions while the shock-mounted microphone capsule provides optimum suppression of handling noise.

Features

- True condenser vocal microphone
- Large diaphragm capsule in true condenser design
- Very detailed, yet warm and full sound
- Excellent feedback rejection
- Switchable pick-up pattern (cardioid/super-cardioid) due to dual diaphragm transducer
- Low-cut filter switch
- Switchable preattenuation (-10 dB)
- Shock-mounted capsule provides optimum suppression of handling noise
- Highly effective, integral pop and windshield
- Extremely rugged design for rough stage use

Product overview

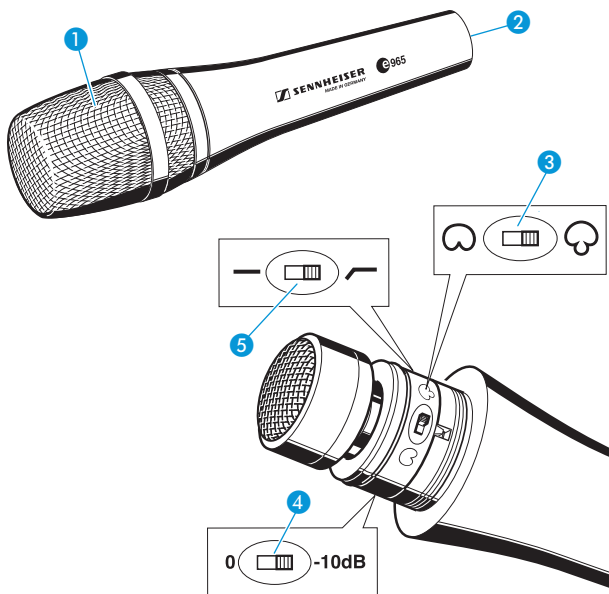

1 Sound inlet basket

2 XLR-3M connector

3 Directivity switch

4 Sensitivity switch

5 Bass roll-off switch

Connecting the microphone

- ▶ Use a microphone cable with XLR-3 female connector to connect the microphone's XLR-3 male connector ② to the microphone preamplifier. The microphone preamplifier must provide 48 V phantom powering.

Pin assignment of the XLR-3 connector

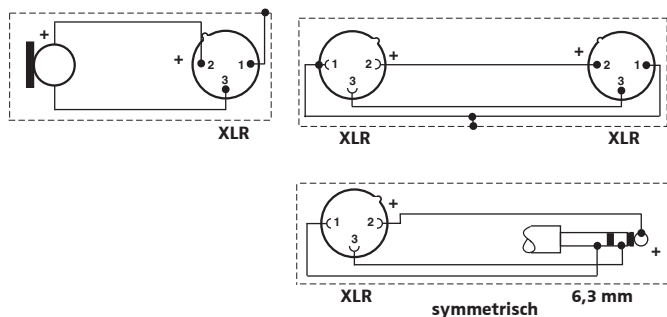

Using the microphone

CAUTION! Danger of damage to the microphone!



The switches on the microphone can be damaged if you try to operate them using tools.

▶ **Only** operate the switches on the microphone using your fingers.

Unscrewing the sound inlet basket

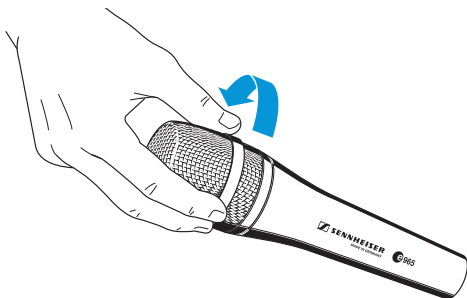

Unscrew the sound inlet basket in order to have access to the following moisture-protected switches:

- Directivity switch **3**



- Sensitivity switch **4**



- Bass roll-off switch **5**



Adjusting the pick-up pattern (cardioid/super-cardioid)

The 965 offers the possibility to adjust the pick-up pattern to fit the application.

Cardioid is the most commonly used pick-up pattern for live PA applications. It provides good on-stage freedom and also picks up sound from the sides. The “dead” side is at the rear. This pattern is good for picking up several vocalists at once, e.g. a choir or ensemble.

Super-cardioid is particularly sensitive to sound coming from the front and reduces pickup from the sides. This pattern is therefore best for picking up an individual sound source in a noisy environment. Crosstalk from other instruments on stage is drastically reduced. Select the super-cardioid pick-up pattern to ensure maximum vocal projection even with very loud on-stage levels.

- ▶ Use the directivity switch 3 to select the desired setting:

☺ : cardioid

☺ : super-cardioid

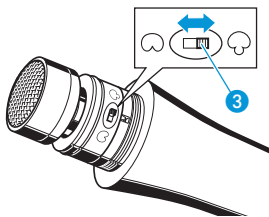

Notes:

In order to prevent feedback and crosstalk, position your monitor loudspeakers in the angle area of the highest cancellation of the microphone (cardioid: 180°; super-cardioid: 135°).

Select the pick-up pattern according to the number and position of your monitor loudspeakers.

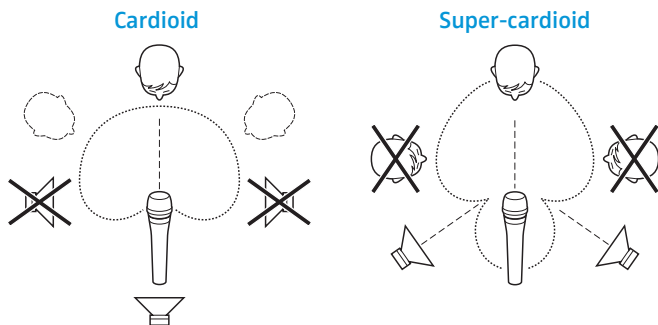

Adjusting the sensitivity

When very high signal levels cause distortion in the microphone or in the subsequent microphone preamplifier, you can reduce the microphone sensitivity. The sensitivity can be reduced by 10 dB.

- ▶ Use the sensitivity switch ④ to select the desired setting:

0: normal sensitivity

-10 dB: sensitivity reduced by 10 dB

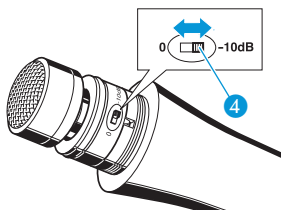

Switching the low-cut filter on/off

In order to effectively reduce low-frequency pop or wind noise, you can switch in the low-cut filter (bass roll-off).

- ▶ Use the low-cut filter switch 5 to select the desired setting:

— : low-cut filter off

∩ : low-cut filter on

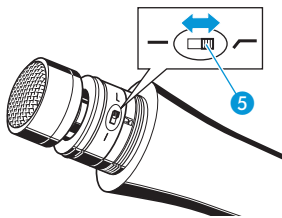

Positioning the microphone

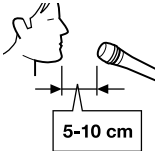
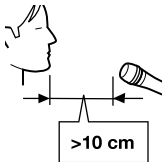
Position	Resulting sound	Comment
	<ul style="list-style-type: none">• High proximity effect (large bass boost)• Powerful, direct sound	Very little crosstalk from other sound sources
	<ul style="list-style-type: none">• Less proximity effect (less bass boost)• Some room ambience, natural, balanced sound	More crosstalk from other sound sources
	<ul style="list-style-type: none">• Very little proximity effect (minimal bass boost)• More room ambience, indirect sound	Higher crosstalk from other sound sources

If sibilance or “popping” occurs, position the microphone slightly to the side and not directly in front of the mouth.

Overview of microphone applications

Application	Variant													
	e901	e902	e904	e905	e906	e908B	e908B ew	e908D	e908T ew	e912	e912 S	e914	e935/e945	e965
Vocals													X	X
Choirs										X		X		
Studio, acoustic instruments					X					X		X		
Orchestra												X		
Trumpet, trombone			X			X			X					
Saxophone			X			X	X							
Acoustic guitar												X		
Acoustic bass												X		
Guitar amplifiers					X									
Bass amplifiers		X												
Leslie	X	X	X	X										
Piano, grand piano										X		X		
Kick drums	X	X												
Snare drums			X	X	X			X						
Rack toms			X	X	X	X		X						
Floor toms		X	X	X	X			X						
Congas			X		X	X		X						

	Variant													
Application	e901	e902	e904	e905	e906	e908B	e908B ew	e908D	e908T ew	e912	e912 S	e914	e935/e945	e965
Cymbals												x		
Percussion			x	x	x	x		x				x		
Overheads														
Conference table, altar										x	x			
Lectern										x	x			
Theater stage										x	x			

Care and maintenance

CAUTION! Liquids can damage the electronics of the microphone!



Liquids entering the housing of the microphone can cause a short-circuit and damage the electronics.

- ▶ Use a soft, slightly damp cloth to clean the microphone. Do not use any solvents or cleansing agents.

To clean the microphone's sound inlet basket from time to time, proceed as follows:

- ▶ Unscrew the sound inlet basket ① from the microphone (see "Unscrewing the sound inlet basket" on page 7).

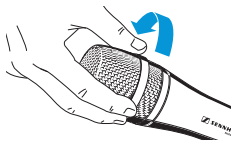

- ▶ Remove the foam insert from the sound inlet basket ①.
- ▶ Use a slightly damp cloth to clean the sound inlet basket from the inside and outside.
- ▶ Reinsert the foam insert into the sound inlet basket ①.
- ▶ Replace the sound inlet basket ① on the microphone and screw it tight.

Specifications

Transducer principle	externally polarized dual diaphragm AF condenser microphone
Diameter of diaphragm	25.4 mm/1"
Frequency response	40 to 20,000 Hz
Pick-up pattern	cardioid/super-cardioid, switchable
Sensitivity (free field, no load)(1 kHz)	7 mV/Pa
with preattenuation	2.3 mV/Pa
Nominal impedance	approx. 50 Ω
Min. terminating impedance	1 k Ω
Max. SPL at 1 kHz	142 dB
with preattenuation	152 dB
Equivalent noise level A-weighted (DIN IEC 651)	21 dB
Phantom powering	48 V/3.5 mA
Connector	XLR-3M
Temperature range	0 °C to +40 °C
Weight	396 g
Dimensions	∅ 48 x 199 mm

Polar diagrams and frequency response curves

Cardioid polar diagram

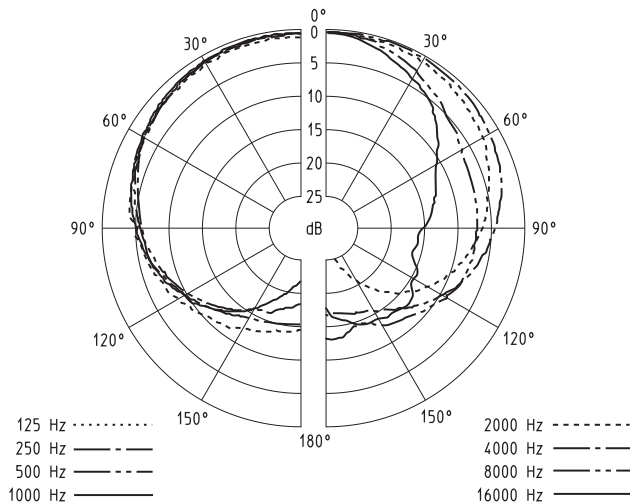

Cardioid frequency response curve

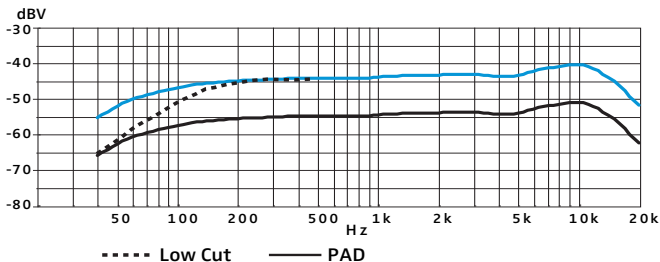

Super-cardioid polar diagram

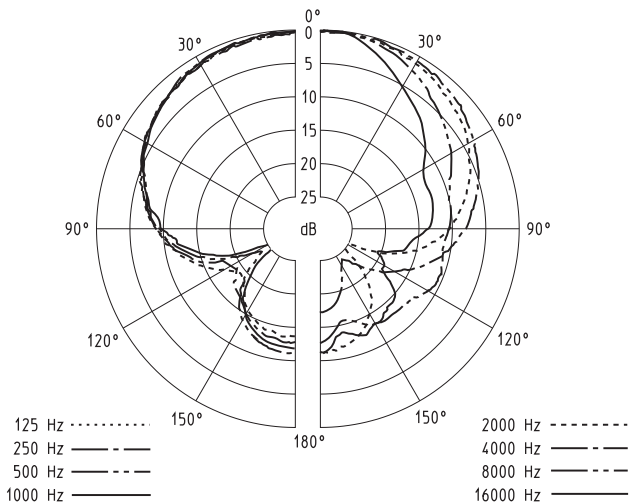

Super-cardioid frequency response curve

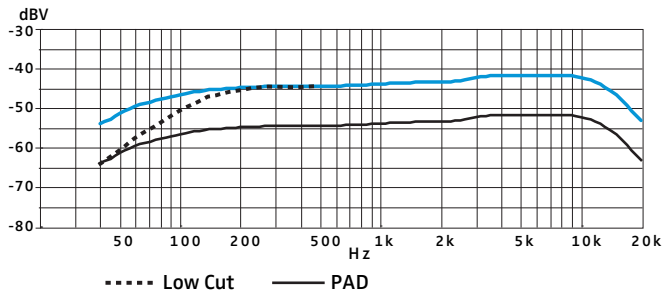

Manufacturer Declarations

Warranty

2 years

CE Declaration of Conformity



Sennheiser electronic GmbH & Co. KG declare that this device is in compliance with the applicable CE standards and regulations.

Before putting the device into operation, please observe the respective countryspecific regulations!

WEEE Declaration



Please dispose of this product at the end of its operational lifetime by taking it to your local collection point or recycling centre for such equipment.





Sennheiser electronic GmbH & Co. KG
Am Labor 1
30900 Wedemark, Germany

Phone +49 (5130) 600 0
Fax +49 (5130) 600 300
www.sennheiser.com

Printed in Germany
Publ. 04/08
524141/A01