

3B Adjusting Input Level with Apogee Maestro App

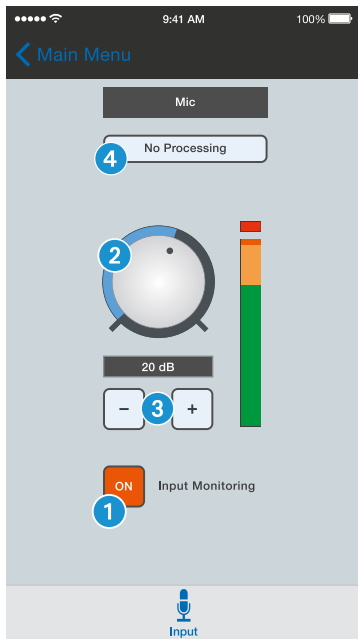

- ▶ Open Apogee Maestro app and choose *Sennheiser MKE 2 digital* from the main menu.



- ▶ Tap the *Input Monitoring* button to hear your microphone input.

- 1 Turn the *Gain Adjustment* knob to increase or decrease the microphone input to the desired level. Small adjustments can also be made by pressing either the “-” or “+” buttons 3.

Tips for Setting Input Level

The best way to do this is to monitor the loudest sound you will be recording and adjust the input gain so the input metering remains green, yellow or orange and not red. If the microphone input meter becomes red when recording, the input is too high and the recording will be distorted.

- 4 Select an *Input Processing* preset. The presets use onboard DSP processing to shape the sound with EQ, compression and limiting to achieve the most natural or unique result. Select *No Processing* or leave as is to bypass this feature.

3C Apple Watch Remote Control

MetaRecorder offers an Apple Watch App to remotely operate these controls.



- 1 Tap to operate transport controls.
- 2 Force tap to toggle favorite status.
- 3 Tap to add a marker.
- 4 Tap to reset max. peak display.
- 5 Tap “+” or “-” to adjust input gain.

4 Recording



- Note: It is recommended that you set your iOS device to airplane mode to prevent any incoming calls from disrupting your recordings.

- ▶ Open Apogee MetaRecorder or any other Core Audio compatible recording App. MKE 2 digital should be automatically detected and selected as the input device.
- ▶ If you haven't already done so, connect headphones to the built-in output on your iOS device and enable input monitoring in the recording App.
- ▶ Tap the *Record* button 1 in the App to begin.

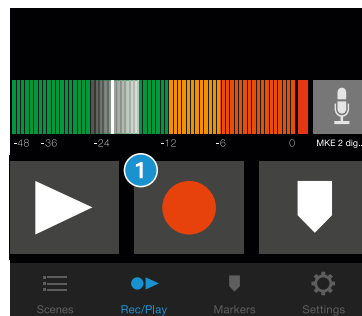

Quick Start Guide MKE 2 digital



Powered by



SENNHEISER

Attachment of the Microphone

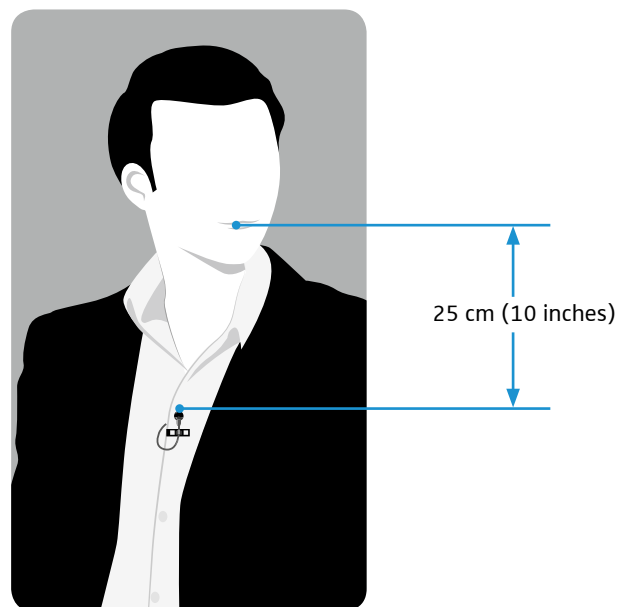

- For more info on Apogee MetaRecorder and other compatible apps, visit www.apogeedigital.com/apps

SENNHEISER

Sennheiser electronic GmbH & Co. KG

Am Labor 1, 30900 Wedemark, Germany
www.sennheiser.com

Printed in USA, Publ. 04/15, 560098/A06

Overview



- 1 Sennheiser MKE 2 microphone capsule
- 2 Apple MFi certified Lightning connector
- 3 Apogee PureDigital Enhanced A/D conversion circuitry

In the Box

- | | |
|----------------------------|---------------------|
| 1 MKE 2 digital microphone | 1 Foam windshield |
| 1 Clip | 1 Carrying pouch |
| 1 Metal wind screen | 1 Quick Start Guide |

System Requirements

- iPhone 6, iPhone 6 plus, iPhone 5s, iPhone 5c, iPhone 5
 - iPad Air 2, iPad Air, iPad (4th generation)
 - iPad mini 3, iPad mini 2, iPad mini
 - iPod touch (5th generation)
 - iOS version: 8.0 and later
 - Apogee MetaRecorder App, Apogee Maestro App or any Core Audio compatible App on iOS
 - Apogee MetaRecorder allows you to record audio and control your MKE 2 digital microphone.
 - Apogee Maestro allows you to control your MKE 2 digital microphone.
- This is not an App for recording.

Wind Screen

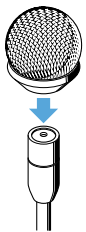

1. This metal wind screen reduces the wind noise by a maximum of 20 dB.

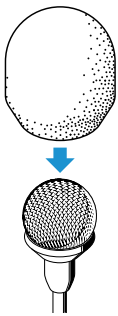

2. You may further reduce the wind noise by 10 dB by means of the foam-net wind screen.

Clip

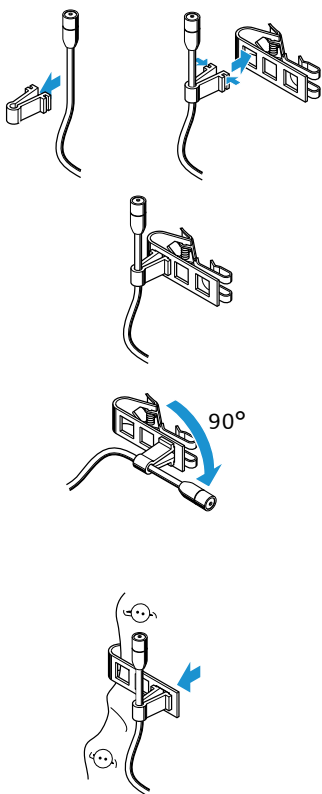

For thin clothes (e.g. silk), please use the outer hole where the clip's contact pressure is the highest.

1 Installing the App

- ▶ Install Apogee MetaRecorder or Apogee Maestro from Apple's App Store for iOS.



Apogee MetaRecorder



Apogee Maestro

- Note:** It is possible to record with MKE 2 digital using any Core Audio compatible App.

2 Connecting to your iOS Device

- ▶ Connect MKE 2 digital to the Lightning port on your iPhone, iPad or iPod touch. By default, you will not hear MKE 2 digital until input monitoring is enabled in an App.
- ▶ Connect headphones to the built-in analog output on your iPhone, iPad or iPod touch. This is necessary to avoid feedback when monitoring your microphone input.



3A Preparing the Recording



MKE 2 digital's input gain can be controlled from either of Apogee's two iOS Apps or from any recording App that supports Core Audio input control.

Adjusting Input Level with Apogee MetaRecorder App

- 1 Open Apogee MetaRecorder and tap the *Rec/Play* tab.

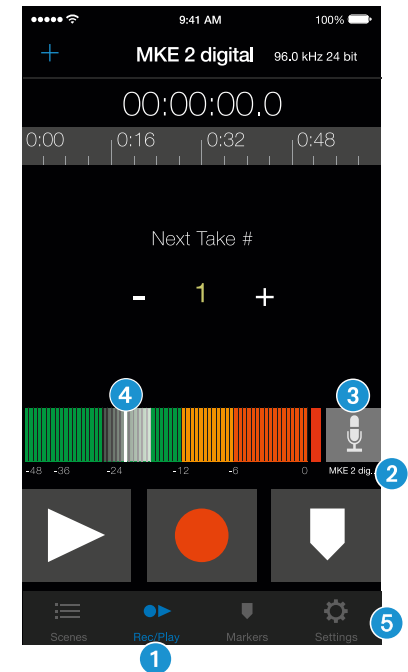

- 2 Confirm that *MKE 2 digital* appears just below the microphone icon.
- 3 Tap the microphone icon to reveal the input level slider.
- 4 Drag the input slider with your finger to adjust the microphone input to the desired level.
- 5 Tap the *Settings* tab and enable input monitoring 6.

