

GLX-D Wireless System – GLXD4 Receiver



User Guide



IMPORTANT SAFETY INSTRUCTIONS

1. READ these instructions.
2. KEEP these instructions.
3. HEED all warnings.
4. FOLLOW all instructions.
5. DO NOT use this apparatus near water.
6. CLEAN ONLY with dry cloth.
7. DO NOT block any ventilation openings. Allow sufficient distances for adequate ventilation and install in accordance with the manufacturer's instructions.
8. DO NOT install near any heat sources such as open flames, radiators, heat registers, stoves, or other apparatus (including amplifiers) that produce heat. Do not place any open flame sources on the product.
9. DO NOT defeat the safety purpose of the polarized or grounding type plug. A polarized plug has two blades with one wider than the other. A grounding type plug has two blades and a third grounding prong. The wider blade or the third prong are provided for your safety. If the provided plug does not fit into your outlet, consult an electrician for replacement of the obsolete outlet.
10. PROTECT the power cord from being walked on or pinched, particularly at plugs, convenience receptacles, and the point where they exit from the apparatus.
11. ONLY USE attachments/accessories specified by the manufacturer.
12. USE only with a cart, stand, tripod, bracket, or table specified by the manufacturer, or sold with the apparatus. When a cart is used, use caution when moving the cart/apparatus combination to avoid injury from tip-over.
13. UNPLUG this apparatus during lightning storms or when unused for long periods of time.
14. REFER all servicing to qualified service personnel. Servicing is required when the apparatus has been damaged in any way, such as power supply cord or plug is damaged, liquid has been spilled or objects have fallen into the apparatus, the apparatus has been exposed to rain or moisture, does not operate normally, or has been dropped.
15. DO NOT expose the apparatus to dripping and splashing. DO NOT put objects filled with liquids, such as vases, on the apparatus.
16. The MAINS plug or an appliance coupler shall remain readily operable.
17. The airborne noise of the Apparatus does not exceed 70dB (A).
18. Apparatus with CLASS I construction shall be connected to a MAINS socket outlet with a protective earthing connection.
19. To reduce the risk of fire or electric shock, do not expose this apparatus to rain or moisture.
20. Do not attempt to modify this product. Doing so could result in personal injury and/or product failure.
21. Operate this product within its specified operating temperature range.



This symbol indicates that dangerous voltage constituting a risk of electric shock is present within this unit.



This symbol indicates that there are important operating and maintenance instructions in the literature accompanying this unit.

WARNING: This product contains a chemical known to the State of California to cause cancer and birth defects or other reproductive harm.



WARNING: Danger of explosion if battery incorrectly replaced. Operate only with Shure compatible batteries.

WARNING: Battery packs shall not be exposed to excessive heat such as sunshine, fire, or the like.



WARNING

- Battery packs may explode or release toxic materials. Risk of fire or burns. Do not open, crush, modify, disassemble, heat above 140°F (60°C), or incinerate
- Follow instructions from manufacturer
- Never put batteries in mouth. If swallowed, contact your physician or local poison control center
- Do not short circuit; may cause burns or catch fire
- Do not charge or use battery packs with other than specified Shure products
- Dispose of battery packs properly. Check with local vendor for proper disposal of used battery packs

Note:

- This equipment is intended to be used in professional audio applications.
- EMC conformance is based on the use of supplied and recommended cable types. The use of other cable types may degrade EMC performance.
- Use this battery charger only with the Shure charging modules and battery packs for which it is designed. Use with other than the specified modules and battery packs may increase the risk of fire or explosion.
- Changes or modifications not expressly approved by Shure Incorporated could void your authority to operate this equipment.

Note: Use only with the included power supply or a Shure-approved equivalent.

System Overview

The new groundbreaking GLX-D Wireless Systems from Shure combine the leading edge of Automatic Frequency Management technology with best-in-class intelligent lithium-ion battery rechargeability, world-renowned microphones and unparalleled design and construction. Available in a wide offering of bodypack and handheld configurations - including vocal, headset and presenter systems as well as traditional guitar options. The revolutionary GLX-D Wireless Systems define the newest standard for seamless ease of operation and exceptional digital audio clarity.

- Exceptional digital audio clarity
- Operates in 2.4 GHz spectrum, available worldwide
- Rechargeable batteries deliver cost-efficiency and up to 16 hours of runtime
- Adjustable transmitter gain to optimize audio signal
- Automatically moves away from interference without audio interruption
- RF back-channel for remote control of transmitter functions
- Globally-unlicensed 2.4 GHz frequency band allows operation of up to 4 compatible systems in a typical setting and up to 8 compatible systems under ideal conditions
- Automatic transmitter power-off to conserve battery life when transmitter is not in use

Included Components

Shure Rechargeable Battery	SB902
Micro USB Battery Charger	SBC-USB
Power Supply	PS42
Carrying Case	95E16526

Optional Accessories

Car Battery Charger	SBC-CAR
Stand Alone Single Battery Charger	SBC-902

Quick Start

To reduce set up time, the transmitter and receiver automatically link to form an audio channel the first time they are powered on and never have to be linked again.

Note: When setting up multiple receiver systems, turn on and link each transmitter/receiver pair one at a time to prevent cross-linking.

Step ①

Connect power supply to the receiver and plug cord into an AC power source. Connect the audio output to an amplifier or mixer.

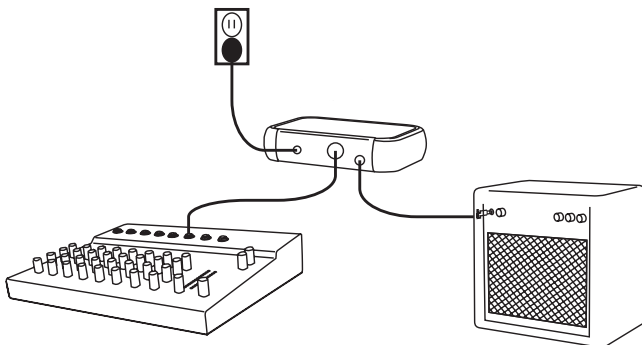

Step ②

Install charged transmitter batteries.

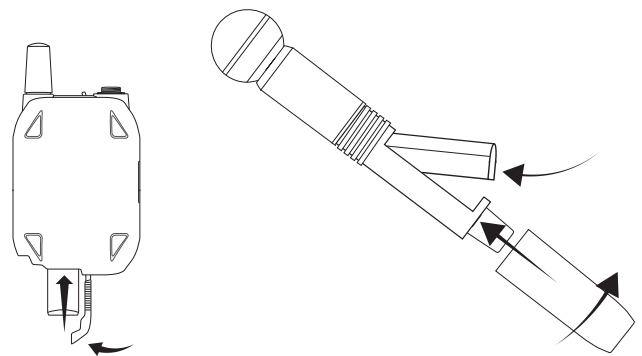

Step ③

Turn on the transmitter and receiver. The blue RF LED will flash while the transmitter and receiver form a link. When the link has successfully formed, the RF LED will remain illuminated.

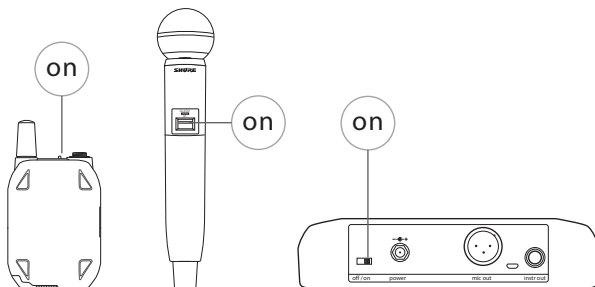

Note: The transmitter and receiver will remain linked for future usage. At power-up, the blue RF LED will illuminate, skipping the linking step.

Step ④

Check the audio and adjust the gain if necessary.

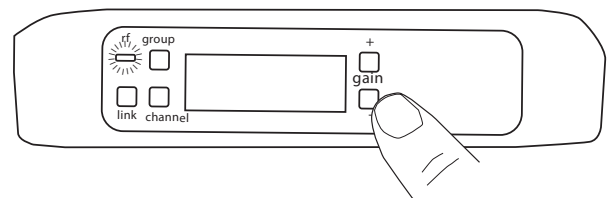

GLXD4 Receiver Controls and Connectors

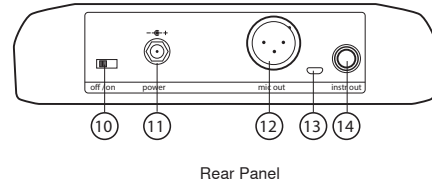
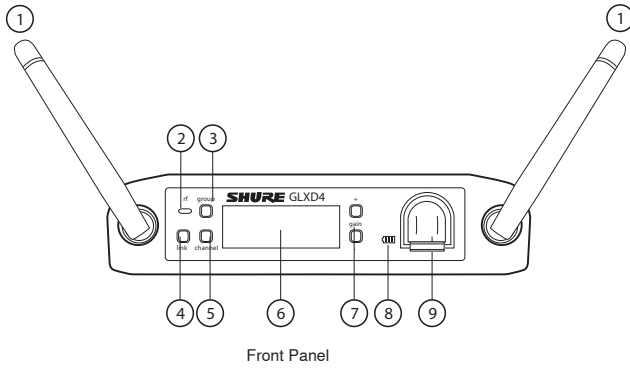

① Antenna

Two antennas per receiver. Antennas pick up the signal from the transmitter.

② RF Status LED

- ON = Linked transmitter is on
- Flashing = Searching for transmitter
- OFF = Linked transmitter off or transmitter unlinked

③ Group Button

Press and hold for two seconds to enable manual group edit.

④ Link Button

Press to manually link receiver to a transmitter or to activate the remote ID function

⑤ Channel

- Momentary press to start a channel scan
- Press and hold 2 seconds to enable manual channel edit

⑥ LCD Screen

Displays receiver and transmitter status.

⑦ Gain Buttons

Press to increase or decrease transmitter gain in 1 dB increments.

⑧ Battery Charging Indicator

Illuminates when battery is in charging bay:

- Red = battery charging
- Green Flashing = battery charge > 90%
- Green = battery charged
- Amber Flashing = charging error, replace battery

⑨ Battery Charging Bay

Charges transmitter battery while receiver is powered.

⑩ Power Switch

Powers the unit on and off.

⑪ Power Supply Jack

Connect the supplied 15 V DC external power supply.

⑫ Mic Out

XLR microphone output jack supplies microphone-level audio output.

⑬ USB Port

For uploading firmware updates

⑭ Instr Out

TRS 1/4" (6.35mm) audio output. Connect to mixers, recorders, and amplifiers.

Receiver Screen

① Group

Displays the selected group.

② Channel

Displays the selected channel.

③ Transmitter Battery Runtime

Displays remaining battery life in hours and minutes.

Alternatively displays the following battery status:

- CALC = battery life calculation
- Lo = battery life less than 15 minutes
- Err = replace battery

④ Audio Meter

Indicates audio signal level and peaks.

⑤ Gain

Displays transmitter gain settings (dB).

⑥ OL Indicator

Indicates audio overload, reduce gain.

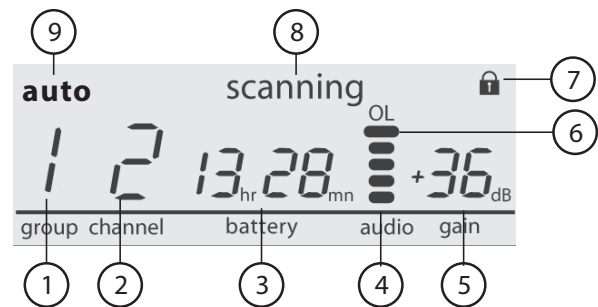

⑦ Transmitter Locked

Displayed when linked transmitter controls are locked.

⑧ Scanning

Indicates a scan is in progress.

⑨ Auto

Indicates that the selected group has backup channels available.

Transmitters

① **Antenna**

Carries wireless signal.

② **Status LED**

LED color and state indicate transmitter status.

③ **Power Switch**

Turns the transmitter on/off.

④ **TA4M Input Jack**

Connects to a 4-Pin mini connector (TA4F) microphone or instrument cable.

⑤ **Micro USB Charging Port**

Connect to USB battery charger.

⑥ **Link Button**

- Press and hold within 5 seconds of power-on to manually link with receiver
- Press momentarily to activate Remote ID function

⑦ **Battery Compartment**

Holds 1 Shure rechargeable battery.

⑧ **Microphone Cartridge**

GLXD-2 transmitter models are available with the following cartridge types: SM58, Beta 58, SM86, Beta 87A.

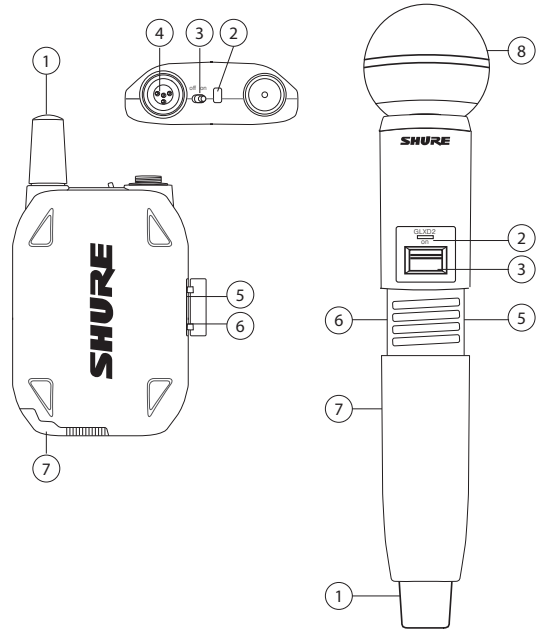

Transmitter Status LED

LED is green during normal operation.

LED color or flashing indicates a change in transmitter status as shown in the following table:

Color	State	Status
Green	Flashing (slow)	transmitter attempting relink with receiver
	Flashing (fast)	unlinked transmitter searching for receiver
	Flashes 3 times	indicates locked transmitter when power switch is pressed
Red	On	battery life < 1 hour
	Flashing	battery life < 30 minutes
Red/Green	Flashing	remote ID active
Amber	Flashing	battery error, replace battery

Wearing the Bodypack Transmitter

Clip the transmitter to a belt or slide a guitar strap through the transmitter clip as shown.

For best results, the belt should be pressed against the base of the clip.

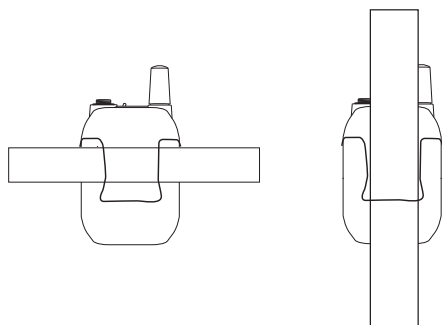

Wearing the Headworn Microphone

- Position the headworn microphone 13 mm (1/2 in.) from the corner of your mouth.
- Position lavalier and headworn microphones so that clothing, jewelry, or other items do not bump or rub against the microphone.

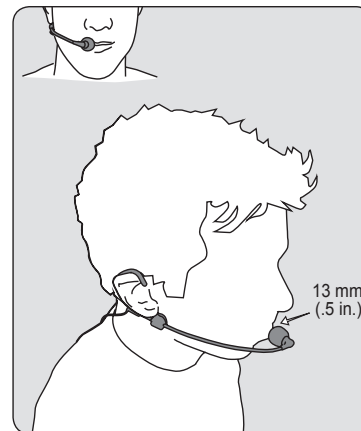

Correct Microphone Placement

- Hold the microphone within 12 inches from the sound source.
- For a warmer sound with increased bass presence, move the microphone closer to the sound source.
- Do not cover grille with hand.

Batteries and Charging

GLX-D transmitters are powered by Shure SB902 lithium-ion rechargeable batteries. Advanced battery chemistry maximizes runtimes with zero memory effects, eliminating the need to discharge batteries prior to charging.

When not in use, recommended battery storage temperature is 10°C (50°F) to 25°C (77°F).

Note: The transmitter will not pass RF or audio signals when connected to the charging cable.

The following battery charging options are available:

Receiver Charging Bay

The GLXD4 receiver has a built-in charging bay for the transmitter batteries.

1. Insert the battery into the charging bay.
2. Monitor the battery charging indicator on the front panel until charging is complete.

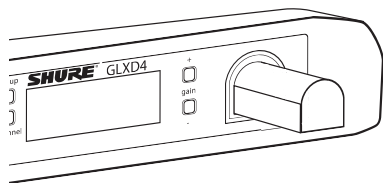

Charging from an AC Power Source

1. Plug the charging cable into the charging port on the transmitter.
2. Plug the charging cable into an AC power source.

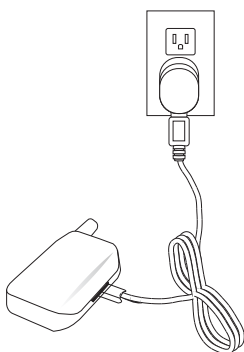

Charging from a USB Port

1. Plug the USB charging cable into the charging port on the transmitter.
2. Plug the cable into a standard USB port.

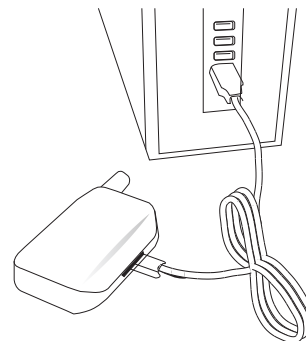

LED Status During Charging

The following LED states indicate battery status when the transmitter is connected to a charger:

- Green = charging complete
- Green Flashing = battery charge > 90%
- Red = battery charging
- Amber Flashing = battery error, replace battery

Installing Transmitter Batteries

Bodypack Transmitter

1. Move the locking lever to the open position and slide the battery door open.
2. Place the battery into the transmitter.
3. Close the battery door and slide the latch to lock.

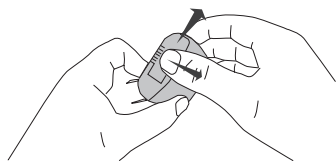

Handheld Transmitter

1. Unscrew and remove the battery cover.
2. Place the battery into the transmitter.
3. Replace and tighten the battery cover.

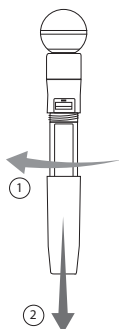

Charging Times and Transmitter Runtimes

Use the following table to determine approximate battery runtime based on the duration of charging time. Times shown are in hours and minutes.

Receiver Bay or AC Power Source Charging	USB Connection Charging	Transmitter Runtime
0:15	0:30	up to 1:30
0:30	1:00	up to 3:00
1:00	2:00	up to 6:00
3:00	4:00	up to 16:00*

*Storage time or excessive heat will reduce maximum runtime.

Note: GLX-D transmitters automatically power-off after approximately 1 hour to conserve battery life if the signal from a linked receiver is not detected.

Important Tips for Care and Storage of Shure Rechargeable Batteries

Proper care and storage of Shure batteries results in reliable performance and ensures a long lifetime.

- Always store batteries and transmitters at room temperature
- Ideally, batteries should be charged to approximately 40% of capacity for long-term storage
- During storage, check batteries every 6 months and recharge to 40% of capacity as needed

Multiple Receiver Systems

For ease of set up, available frequencies are divided into three groups based on the number of receivers supported.

All receivers in the system must be set to the same group. To select a group, determine the total number of receivers in the system (channel count), and then select the appropriate group.

Note: To maximize the number of receivers on-air, Group 3 does not offer backup frequencies. Group 3 should only be used in controlled Wi-Fi environments to prevent interference from unexpected Wi-Fi devices.

Group	Channel Count	Backup Frequencies Available?	Notes
1	Up to 4	Yes	Initial Factory Setting.
2	Up to 5	Yes	Best Group to use if you experience interference.
3	Up to 8	No	Only use Group 3 in controlled Wi-Fi environments because there are no backup frequencies to avoid interference.

Note: If you experience interference, reduce transmitter to receiver distance and set all GLX-D systems to group 2, which is the most robust wireless group.

See "Tips to Improve Wireless System Performance" section for additional information.

Setting Up Receivers and Transmitters

Note: Before beginning, turn off all receivers and transmitters. Turn on and set up each receiver/transmitter pair individually to prevent cross-linking.

1. Turn on the first receiver.
2. Press and hold the group button to select a group (if necessary) or if the group is already set, press the channel button to scan for the best available channel.
3. Turn on the first transmitter. The blue r-f LED will illuminate when a link is established.

Repeat steps 1-3 for each additional receiver and transmitter. Remember to set each receiver to the same group.

Note: Dashes appearing on the group and channel display during a channel scan indicate that frequencies are not available in the selected group. Choose a group that supports more receivers and repeat the set up steps.

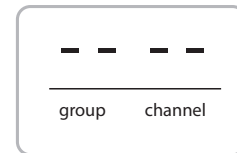

Manually Linking a Transmitter to a Receiver

Use the manual linking option to change the transmitter linked to a receiver. A common use for manual linking is changing the linked transmitter from a bodypack type to a handheld type.

1. Turn on the transmitter: Within 5 seconds, press and hold the LINK button until the transmitter LED begins to flash green.
2. Press and hold the link button on the receiver: The blue r-f LED will flash, and then remain on when the link has been established.
3. Test the audio to verify the link and adjust the gain if necessary.

Combo Systems

A combo system is created by linking two transmitters to a single receiver. Only one transmitter can be active at a time to prevent cross interference. Gain settings for each transmitter can be independently set and stored when the transmitter is active.

Important! Do not turn on and operate both linked transmitters at any time.

Turn off both transmitters before beginning.

1. Press the group button to select a group. The receiver automatically scans the selected group to find the best available channel.
2. Turn on transmitter 1 and link it to the receiver. Adjust the gain, and then turn off the transmitter.
3. Turn on transmitter 2 and link it to the receiver. Adjust the gain, and then turn off the transmitter.

2.4 GHz Spectrum Overview

GLX-D operates within the 2.4GHz ISM band which is utilized by Wi-Fi, Bluetooth, and other wireless devices. The benefit of 2.4GHz is that it's a global band that can be used anywhere in the world, license free.

Overcoming the Challenges of 2.4GHz

The challenge of 2.4GHz is that Wi-Fi traffic can be unpredictable. GLX-D meets these challenges in the following ways:

- Prioritizes and transmits on the best 3 frequencies per channel (choosing from a pool of 6 frequencies across the 2.4GHz band)
- Repeats the most important information such that one frequency can be taken out entirely without audio interruption
- Continuously scans during usage to rank all frequencies (both current and backup frequencies)
- Seamlessly moves away from interference to backup frequencies without audio interruption

Note: Unlike analog TV band wireless which typically uses the same type of transmissions across manufacturers, all 2.4GHz wireless currently on the market use different variations of wireless transmission. These differences make it more difficult to mix and match 2.4 GHz from multiple manufacturers successfully, as can be done with TV band wireless solutions.

Coexisting with Wi-Fi

If you plan to use Wi-Fi during a performance, turn on Wi-Fi devices prior to turning on GLX-D and scanning for the best channel. GLX-D detects and avoids other Wi-Fi traffic by scanning the entire 2.4GHz environment and selecting the 3 best frequencies to transmit on. The result of this is reliable performance for your GLX-D wireless system as well as avoiding Wi-Fi transmissions which may be important as well.

“Bursting” Wi-Fi is harder to detect as it is periodic; however, because GLX-D repeats the most important information, even bursts at very high-levels don't have an effect on your audio performance.

Challenging Wireless Environments

Some environments are more difficult than others for 2.4 GHz wireless system performance. Additionally, body absorption has a greater impact in the 2.4 GHz spectrum, compared to the UHF spectrum. The simplest solution in many cases is to reduce the transmitter to receiver distance such as placing the receivers on the stage with a clear line of sight.

Challenging environments include:

- Areas with few reflective surfaces such as:
 - Outdoors
 - Buildings with very high ceilings
- 3 or more GLX-D receivers in use
- Strong Wi-Fi presence
- Competitive 2.4 GHz systems in use

Tips and Methods to Improve Wireless System Performance

If you encounter interference or dropouts, try the following suggestions:

- Scan for the best available channel (press the channel button)
- Reduce transmitter to receiver distance - for example, place receivers on stage with a line of sight to the front of the receiver.
- Change all GLX-D systems to Group 2, which is the most robust wireless group
- Move receiver further away from Wi-Fi access points, computers, or other active 2.4 GHz sources. Recommended distance is a minimum of 3 meters (10 feet).
- Disable non-critical Wi-Fi on computers, cell phones, and other portable devices
 - If you plan to use Wi-Fi during a performance, turn on Wi-Fi prior to turning on GLX-D and scanning for the best channel.
- Keep the transmitter and receiver more than 2 meters (6 feet) apart
- Avoid heavy Wi-Fi traffic activities such as downloading large files or viewing a movie.
- Locate competitive 2.4 GHz receivers away from each other
- Avoid placing transmitter and receiver where metal or other dense materials may be present
- Move the receiver to the top of the equipment rack
- Keep transmitters more than 2 meters (6 feet) apart - this is less critical at shorter receiver to transmitter distances
 - Note:** If transmitters are within 6 inches of non-GLXD transmitters or microphone cartridges, audible noise is possible.
- During sound check, mark trouble spots and ask presenters or performers to avoid those areas
- If there is a known strong source of Wi-Fi and you specifically want to use frequencies within that Wi-Fi channel, use the following Group/Channel of GLX-D (best option listed first):
 - **Wi-Fi 1:** Group 3/Channel 8, Group 3/Channel 4
 - **Wi-Fi 6:** Group 3/Channel 7, Group 3/Channel 5
 - **Wi-Fi 11:** Group 3/Channel 2, Group 3/Channel 1

2.4 GHz Frequency Tables

The following tables list receiver channels, frequencies, and latency for each group:

Group 1: Channels 1-4 (latency = 4.0 ms)

Group/Channel	Frequencies
1/1	2424 2425 2442 2443 2462 2464
1/2	2418 2419 2448 2450 2469 2471
1/3	2411 2413 2430 2431 2476 2477
1/4	2405 2406 2436 2437 2455 2457

Group 2: Channels 1-5 (latency = 7.3 ms)

Group/Channel	Frequencies
2/1	2423 2424 2443 2444 2473 2474
2/2	2404 2405 2426 2427 2456 2457
2/3	2410 2411 2431 2432 2448 2449
2/4	2417 2418 2451 2452 2468 2469
2/5	2437 2438 2462 2463 2477 2478

Group 3: Channels 1-8 (latency = 7.3 ms)

Group/Channel	Frequencies
3/1	2415 2416 2443
3/2	2422 2423 2439
3/3	2426 2427 2457
3/4	2447 2448 2468
3/5	2409 2451 2452
3/6	2431 2462 2463
3/7	2404 2473 2474
3/8	2435 2477 2478

Operation

Gain Adjustment

Use the gain buttons on the receiver to increase or decrease the gain of a linked transmitter:

- Turn on the linked transmitter and momentarily press the gain buttons to adjust the gain in 1 dB increments
- For faster gain adjustments, press and hold the gain buttons

Tip: Monitor the audio and observe the receiver audio meter level while adjusting the gain to prevent signal overload.

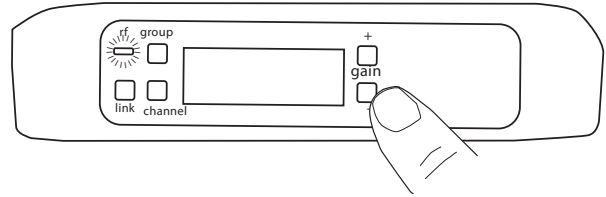

Locking and Unlocking the Controls

The controls of the receiver and transmitter can be locked to prevent accidental or unauthorized changes to settings.

Note: Locks are not affected by power cycles.

Locking the Receiver Controls

Simultaneously press and hold the group and channel buttons until LK appears on the LCD. Repeat to unlock.

- LK is displayed if a locked control is pressed
- UN is displayed momentarily to confirm the unlock command

Locking the Transmitter Power Switch

Starting with the transmitter set to off, press and hold the LINK button while turning on the transmitter. Continue to hold the link button until the lock icon appears on the receiver LCD. Repeat sequence to unlock.



Optionally, the transmitter power switch can be remotely locked from the receiver front panel:

Simultaneously press and hold the group and link buttons for approximately 2 seconds until the flashing lock icon appears on the receiver LCD. Repeat sequence to unlock.

Identifying Linked Transmitters and Receivers with Remote ID

Use the Remote ID feature to identify linked transmitter and receiver pairs in multiple receiver systems. When Remote ID is active, the receiver LCD will blink and display ID. The status LED of the corresponding transmitter will alternately flash red and green for approximately 45 seconds.

To activate Remote ID:

1. Momentarily press the link button on the transmitter or receiver.
2. The LCD of the linked receiver will blink and display ID and the status LED on the linked transmitter will flash red/green.
3. To exit Remote ID mode, momentarily press the link button or allow the function to timeout.

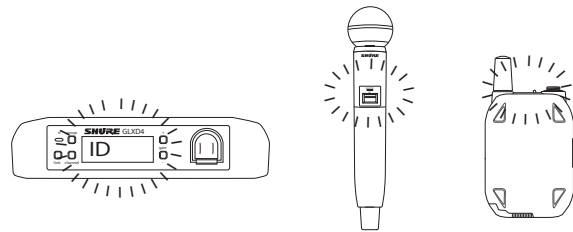

Manually Selecting a Group and Channel

Specific groups and channels can be assigned to the receiver instead of using the automatic scan function.

Note: Group 3 should only be used in controlled Wi-Fi environments to prevent interference from unexpected Wi-Fi devices.

Selecting a Group

1. Press and hold the group button for 2 seconds until the group display flashes.
2. Press the group button to scroll through the available groups.
3. The receiver will automatically save the selected group.

Selecting a Channel

1. Press and hold the channel1 button for 2 seconds until the channel1 display flashes.
2. Press the channel1 button to scroll through the available channels.
3. The receiver will automatically save the selected channel.

Note: A double dash symbol -- displayed on the receiver screen during a channel scan indicates that there are no available channels within the selected group. Choose a group with more channels and repeat set up steps.

Troubleshooting

Issue	Indicator Status	Solution
No sound or faint sound	Receiver RF LED on	<ul style="list-style-type: none"> • Verify all sound system connections or adjust gain as needed (see Adjusting Gain). • Verify that the receiver is connected to mixer/amplifier.
	Receiver RF LED off	<ul style="list-style-type: none"> • Turn on transmitter. • Make sure the batteries are installed correctly. • Link transmitter and receiver (see Linking topic). • Charge or change transmitter battery.
	Receiver LCD screen off	<ul style="list-style-type: none"> • Make sure AC adapter is securely plugged into electrical outlet. • Make sure receiver is powered on.
	Transmitter indicator LED flashing red	Charge or change transmitter battery.
	Transmitter plugged into charger.	Disconnect transmitter from charger.
Audio artifacts or dropouts	rF LED flickering or off	<ul style="list-style-type: none"> • Change receiver and transmitter to a different group and/or channel. • Identify nearby sources of interference (cell phones, Wi-Fi access points, signal processor, etc...) and shutdown or remove source. • Charge or change transmitter battery. • Ensure that receiver and transmitter are positioned within system parameters. • System must be set up within recommended range and receiver kept away from metallic surfaces. • Transmitter must be used in line of sight from receiver for optimal sound.
Distortion	OL indicator appears on receiver LCD	Reduce transmitter gain (see Gain Adjustment).
Sound level variations when switching to different sources	N/A	Adjust transmitter gain as necessary (see Gain Adjustment).
Receiver/transmitter won't turn off	Transmitter LED flashing rapidly	Controls locked. See Locking and Unlocking Controls.
Receiver gain control cannot be adjusted	N/A	Check transmitter. Transmitter must be on to enable gain changes.
Receiver controls cannot be adjusted	LK shown on receiver display when buttons are pressed	Controls locked. See Locking and Unlocking Controls.
Transmitter ID function does not respond	Transmitter LED flashes green 3 times	Controls locked. See Locking and Unlocking Controls.
Transmitter information does not appear on the Receiver LCD	N/A	Linked transmitter is off or the receiver is not linked to a transmitter.
Transmitter powers off after 1 hour	Transmitter status LED off	GLX-D transmitters automatically power-off after 1 hour to conserve battery life if the signal from a linked receiver is not detected. Make sure that linked receiver is turned on.

Resetting Components

Use the reset function if it is necessary to restore the transmitter or receiver to their factory settings.

Resetting the Receiver

Restores the receiver to the following factory settings:

- Gain level = default
- Controls = unlocked

Press and hold the **Link** button while turning on the receiver power until the LCD displays RE.

Note: When reset is complete, the receiver will automatically initiate linking to search for a transmitter. Press and hold the transmitter link button within five seconds of powering-on to complete the link.

Resetting the Transmitter

Restores the transmitter to the following factory settings:

- Controls = unlocked

Press and hold the transmitter link button while turning on the transmitter until power LED goes off.

When the link button is released, the transmitter will automatically initiate linking to find an available receiver. Press the link button on an available receiver to relink.

Specifications

Tuning Bandwidth

2400–2483.5 MHz

Working Range

Indoors	Up to 30 m (100 ft) typical, Up to 60 m (200 ft) maximum
Outdoors	Up to 20 m (65 ft) typical, Up to 50 m (165 ft) maximum

Note: Actual range depends on RF signal absorption, reflection and interference.

Transmit Mode

Frequency Hopping

Audio Frequency Response

20 Hz – 20 kHz

Note: Dependent on microphone type

Dynamic Range

120 dB, A-weighted

RF Sensitivity

-88 dBm, typical

Total Harmonic Distortion

0.2%, typical

RF Output Power

10 mW E.I.R.P. max

Operating Temperature Range

-18°C (0°F) to 57°C (135°F)

Note: Battery characteristics may limit this range.

Storage Temperature Range

-29°C (-20°F) to 74°C (165°F)

Polarity

Positive pressure on microphone diaphragm (or positive voltage applied to tip of WA302 phone plug) produces positive voltage on pin 2 (with respect to pin 3 of low-impedance output) and the tip of the high impedance 1/4-inch output.

Battery Life

Up to 16 hours

Channel Count

4 typical, Up to 8 maximum

GLXD4

Dimensions

40 x 183 x 117 mm (1.6 x 7.2 x 4.6 in.), H x W x D

Weight

286 g (10.1 oz.) without batteries

Housing

Molded Plastic

Power Requirements

14 to 18 V DC (Tip positive with respect to ring), 550 mA

Spurious Rejection

>35 dB, typical

Gain Adjustment Range

-20 to 40 dB in 1 dB steps

Phantom Power Protection

Yes

Configuration

XLR Output	Impedance balanced
6.35 mm (1/4") output	Impedance balanced

Impedance

XLR Output	100 Ω
6.35 mm (1/4") output	100 Ω (50 Ω, Unbalanced)

Maximum Audio Output Level

XLR connector (into 600 Ω load)	+1 dBV
6.35 mm (1/4") connector (into 3 kΩ load)	+8.5 dBV

Pin Assignments

XLR Output	1=ground, 2=hot, 3=cold
6.35 mm (1/4") connector	Tip=audio, Ring=no audio, Sleeve=ground

Receiver Antenna Input

Impedance

50 Ω

Antenna Type

½ Wave Sleeve Dipole, non-removable

Maximum Input Level

-20 dBm

Output Connections

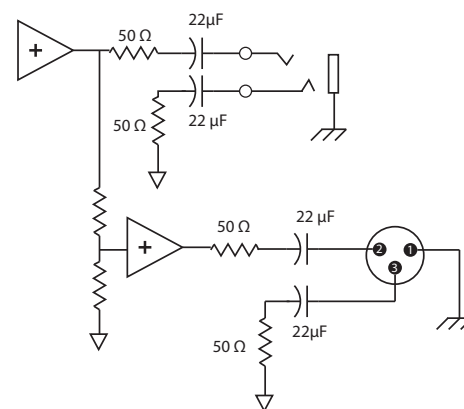

GLXD1

Dimensions

90 x 65 x 23 mm (3.56 x 2.54 x 0.90 in.), H x W x D (without antenna)

Power Requirements

3.7 V Rechargeable Li-Ion

Housing

Cast Metal, Black Powdercoat

Input Impedance

900 k Ω

RF Output Power

10 mW E.I.R.P. max

Transmitter Input

Connector

4-Pin male mini connector (TA4M)

Configuration

Unbalanced

Maximum Input Level

1 kHz at 1% THD
+8.4 dBV (7.5 Vp-p)

Antenna Type

Internal Monopole

Pin Assignments

TA4M

1	ground (cable shield)
2	+ 5 V Bias
3	audio
4	Tied through active load to ground (On instrument adapter cable, pin 4 floats)



TA4M Connector

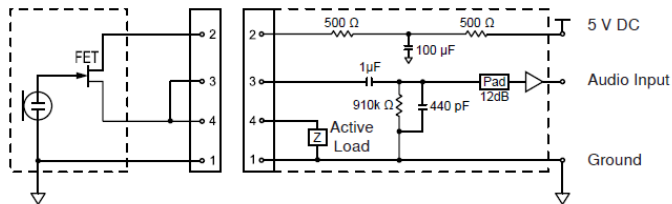

GLXD2

Dimensions

Model	A	B	C
SM58	51 mm, 2.0 in.	252 mm, 9.9 in.	37 mm, 1.5 in.
BETA 58	51 mm, 2.0 in.	252 mm, 9.9 in.	37 mm, 1.5 in.
SM86	49 mm, 1.9 in.	252 mm, 9.9 in.	37 mm, 1.5 in.
BETA 87A	51 mm, 2.0 in.	252 mm, 9.9 in.	37 mm, 1.5 in.

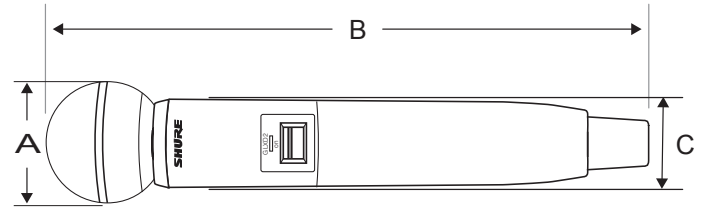

Weight

SM58	267 g (9.4 oz.) without batteries
BETA 58	221 g (7.8 oz.) without batteries
SM86	275 g (9.1 oz.) without batteries
BETA 87A	264 g (9.3 oz.) without batteries

Housing

Molded Plastic

Power Requirements

3.7 V Rechargeable Li-Ion

RF Output Power

10 mW E.I.R.P. max

Maximum Input Level

SM58	146 dB SPL
BETA 58	147 dB SPL
SM86	143 dB SPL
BETA 87A	147 dB SPL

Certifications

This device complies with part 15 of the FCC Rules. Operation is subject to the following two conditions: (1) This device may not cause harmful interference, and (2) this device must accept any interference received, including interference that may cause undesired operation.

This wireless system operates in the globally available ISM band 2400 MHz to 2483.5 MHz. The operation does not require a user license.

Meets requirements of the following standards:

EN 300 328 EN 301 489 Parts 1 and 9 EN60065 Meets essential requirements of the following European Directives:

- R&TTE Directive 99/5/EC
- WEEE Directive 2002/96/EC, as amended by 2008/34/EC
- RoHS Directive 2002/95/EC, as amended by 2008/35/EC

Note: Please follow your regional recycling scheme for batteries and electronic waste

Certified by IC in Canada under RSS-210 and RSS-GEN.

IC: 616A-GLXD1, 616A-GLXD2, 616A-GLXD4

Certified under FCC Part 15.

FCC ID: DD4GLXD1, DD4GLXD2, DD4GLXD4

This Class B digital apparatus complies with Canadian ICES-003. Cet appareil numérique de la classe B est conforme à la norme NMB-003 du Canada.

This device complies with Industry Canada licence-exempt RSS standard(s). Operation of this device is subject to the following two conditions: (1) this device may not cause interference, and (2) this device must accept any interference, including interference that may cause undesired operation of the device.

Le présent appareil est conforme aux CNR d'Industrie Canada applicables aux appareils radio exempts de licence. L'exploitation est autorisée aux deux conditions suivantes : (1) l'appareil ne doit pas produire de brouillage, et (2) l'utilisateur de l'appareil doit accepter tout brouillage radioélectrique subi, même si le brouillage est susceptible d'en compromettre le fonctionnement.

The CE Declaration of Conformity can be obtained from Shure Incorporated or any of its European representatives. For contact information please visit www.shure.com

The CE Declaration of Conformity can be obtained from: www.shure.com/europe/compliance

Authorized European representative:

Shure Europe GmbH

Headquarters Europe, Middle East & Africa

Department: EMEA Approval

Jakob-Dieffenbacher-Str. 12

75031 Eppingen, Germany

Phone: 49-7262-92 49 0

Fax: 49-7262-92 49 11 4

Email: EMEAsupport@shure.de

Information to the user

This equipment has been tested and found to comply with the limits for a Class B digital device, pursuant to Part 15 of the FCC Rules. These limits are designed to provide reasonable protection against harmful interference in a residential installation. This equipment generates uses and can radiate radio frequency energy and, if not installed and used in accordance with the instructions, may cause harmful interference to radio communications. However, there is no guarantee that interference will not occur in a particular installation. If this equipment does cause harmful interference to radio or television reception, which can be determined by turning the equipment off and on, the user is encouraged to try to correct the interference by one or more of the following measures:

- Reorient or relocate the receiving antenna.
- Increase the separation between the equipment and the receiver.
- Connect the equipment to an outlet on a circuit different from that to which the receiver is connected.
- Consult the dealer or an experienced radio/TV technician for help.

This wireless system operates in the globally available ISM band 2400 MHz to 2483.5 MHz. The operation does not require a user license.



**United States, Canada, Latin
America, Caribbean:**

Shure Incorporated
5800 West Touhy Avenue
Niles, IL 60714-4608 USA

Phone: +1-847-600-2000
Fax: +1-847-600-1212 (USA)
Fax: +1-847-600-6446
Email: info@shure.com

www.shure.com

Europe, Middle East, Africa:

Shure Europe GmbH
Jakob-Dieffenbacher-Str. 12,
75031 Eppingen, Germany

Phone: +49-7262-92490
Fax: +49-7262-9249114
Email: info@shure.de

Asia, Pacific:

Shure Asia Limited
22/F, 625 King's Road
North Point, Island East
Hong Kong

Phone: 852-2893-4290
Fax: 852-2893-4055
Email: info@shure.com.hk