

SHURE®

LEGENDARY
PERFORMANCE™

Discussion and Conferencing

Microflex™ Wireless Series

USER GUIDE



IMPORTANT SAFETY INSTRUCTIONS

1. READ these instructions.
2. KEEP these instructions.
3. HEED all warnings.
4. FOLLOW all instructions.
5. DO NOT use this apparatus near water.
6. CLEAN ONLY with dry cloth.
7. DO NOT block any ventilation openings. Allow sufficient distances for adequate ventilation and install in accordance with the manufacturer's instructions.
8. DO NOT install near any heat sources such as open flames, radiators, heat registers, stoves, or other apparatus (including amplifiers) that produce heat. Do not place any open flame sources on the product.
9. DO NOT defeat the safety purpose of the polarized or grounding type plug. A polarized plug has two blades with one wider than the other. A grounding type plug has two blades and a third grounding prong. The wider blade or the third prong are provided for your safety. If the provided plug does not fit into your outlet, consult an electrician for replacement of the obsolete outlet.
10. PROTECT the power cord from being walked on or pinched, particularly at plugs, convenience receptacles, and the point where they exit from the apparatus.
11. ONLY USE attachments/accessories specified by the manufacturer.
12. USE only with a cart, stand, tripod, bracket, or table specified by the manufacturer, or sold with the apparatus. When a cart is used, use caution when moving the cart/apparatus combination to avoid injury from tip-over.
13. UNPLUG this apparatus during lightning storms or when unused for long periods of time.



14. REFER all servicing to qualified service personnel. Servicing is required when the apparatus has been damaged in any way, such as power supply cord or plug is damaged, liquid has been spilled or objects have fallen into the apparatus, the apparatus has been exposed to rain or moisture, does not operate normally, or has been dropped.
15. DO NOT expose the apparatus to dripping and splashing. DO NOT put objects filled with liquids, such as vases, on the apparatus.
16. The MAINS plug or an appliance coupler shall remain readily operable.
17. The airborne noise of the Apparatus does not exceed 70dB (A).
18. Apparatus with CLASS I construction shall be connected to a MAINS socket outlet with a protective earthing connection.
19. To reduce the risk of fire or electric shock, do not expose this apparatus to rain or moisture.
20. Do not attempt to modify this product. Doing so could result in personal injury and/or product failure.
21. Operate this product within its specified operating temperature range.



This symbol indicates that dangerous voltage constituting a risk of electric shock is present within this unit.



This symbol indicates that there are important operating and maintenance instructions in the literature accompanying this unit.

WARNING: This product contains a chemical known to the State of California to cause cancer and birth defects or other reproductive harm.

Table of Contents

| | | | |
|---|-----------|--|-----------|
| Table of Contents | 3 | Networking | 35 |
| System Overview | 4 | Networking Best Practices | 36 |
| General Description | 5 | Description of the Network Interfaces | 36 |
| Features | 5 | Configuring IP Settings | 37 |
| Component Overview | 6 | Advanced Setup | 38 |
| Basic System Concepts | 7 | Software | 40 |
| Hardware Description | 8 | Shure Web Device Discovery Application | 41 |
| Access Point Transceiver (APT) | 9 | MXW System Control Software | 41 |
| Audio Network Interface (ANI) | 10 | Control Software for the MXW Audio Network Interface | 48 |
| Networked Charger (NCS) | 12 | Dante™ Software by Audinate | 51 |
| Microphone Transmitters | 13 | Firmware Updates | 52 |
| Installation | 18 | Additional Topics | 53 |
| Additional Equipment | 19 | Connecting to an External Control System | 54 |
| Rack Installation | 19 | Screw Kit for MXW Chargers | 54 |
| Securing the Networked Charging Station | 19 | Troubleshooting | 55 |
| Mount the Access Point Transceiver | 20 | MXW Accessories and Part Numbers | 57 |
| Power the Hardware | 21 | Microflex Wireless Specifications | 59 |
| Connect the Components | 22 | System | 59 |
| Accessing the MXW Control Software | 23 | Transmitters | 59 |
| Setting Up the System | 24 | Access Point Transceiver (APT) | 60 |
| Overview of Groups and Configurations | 25 | Networked Charging Station (NCS) | 60 |
| Associating Components to a Group | 26 | Audio Network Interface (ANI) | 61 |
| Linking Microphones | 28 | Transmitter Output Power | 62 |
| Creating Separate Configurations | 29 | Wiring Diagram | 62 |
| Exchanging or Removing a Component | 30 | Safety Information | 63 |
| Wireless Management | 31 | Certifications | 64 |
| Overview of Channel Coordination | 32 | | |
| Scanning Available RF Spectrum | 32 | | |
| Setting RF Power | 33 | | |
| Using Multiple 4-Channel Access Points | 34 | | |

System Overview

- **Features** **5**
 - Legendary Shure Quality
 - Advanced Networking and Control
- **Component Overview** **6**
 - Microphone Transmitters
 - Access Point Transceiver (**MXWAPT4**, **MXWAPT8**)
 - Audio Network Interface (**MXWANI4**, **MXWANI8**)
 - Networked Charging Station (**MXWNCS4**, **MXWNCS8**)
 - MXW Control Software
- **Basic System Concepts** **7**
 - Technology Overview of the Audio Path
 - Forming Groups and Linking Microphones
 - Configurations: Managing Multiple Groups
- **Access Point Transceiver (APT)** **9**
 - Directional Antennas

General Description

The Shure Microflex™ Wireless Series (MXW) is a complete microphone solution for flexible meeting rooms and boardrooms. It features automatic RF channel management, rechargeable encrypted (AES256) wireless microphones, and digital audio networking (Dante™). The networked charging station charges boundary and gooseneck microphones for tabletop applications, as well as handheld and bodypack solutions for corporate training and presentations. The MXW Access Point mounts to a ceiling or wall for discreet communication between the wireless microphones and the digital audio network. Multiple access points can be used for installations that require simultaneous operation of up to 40* microphones in the same area (*region dependant). Web-browser based control software is used for remote monitoring and control from any computer connected to the network.



Features

Legendary Shure Quality

Premium Audio

All Microflex microphones are engineered to clearly capture the natural characteristics of voice communications, and include CommShield® Technology which guards against unwanted radio interference from consumer wireless devices such as cell phones and tablets.

Rechargeable Microphones

Each MXW microphone is powered from a rechargeable Lithium-ion battery, which can be charged at any time without removal from the microphone. Lithium-ion chemistry and intelligent Shure circuitry results in a rechargeable battery with no memory effect. Battery statistics are viewable from the control software (battery runtime, time to full charge, charge cycle count and battery capacity).

Discreet, Professional Design

Modern, low-profile wireless microphone designs elegantly integrate into diverse AV environments. By eliminating wires, MXW noticeably reduces clutter and provides professional elegance.

Encryption

The MXW wireless link is encrypted using the Advanced Encryption Standard (AES-256), as specified by the US Government National Institute of Standards and Technology (NIST) publication FIPS-197.

Advanced Networking and Control

Digital Audio Networking

Digital audio is carried over standard Ethernet using shielded Cat5e (or higher) cables. Developed with Dante™ technology by Audinate®, MXW provides low latency, clock synchronization, and high Quality-of-Service (QoS) to provide reliable audio transport. Digital audio can coexist safely on the same network as IT and control data, or can be configured to use a dedicated network.

Automatic Frequency Coordination

The MXW Series uses automatic frequency coordination to quickly set up all of the microphones and achieve reliable, uninterrupted wireless communication. Microphones are assigned to channels on an access point transceiver simply by arranging them in an associated charging station and pressing the Link button. Multiple access point transceivers can work together to support large installations or scalable rooms. Once Linked, the system automatically scans the available RF spectrum and selects the best quality RF channels on which to operate. Upon detecting interference, microphones automatically switch to the best alternate RF channel determined during continuous background scanning.

Remote Control and Monitoring

Microflex Wireless components and software are compatible with Crestron, AMX, and other programmable controllers. Components interconnect with teleconferencing equipment and digital signal processors.

Built-In RF Spectrum Scanner

The MXW Wireless components transmit in unlicensed spectrum that may be used by other wireless devices (in particular wireless phones and headsets) operating in the same area. The MXW access point features an RF scanner to document the average and peak RF interference. The data provides an accurate estimate for the number of MXW channels that can be safely operated in the scanned area.

Component Overview

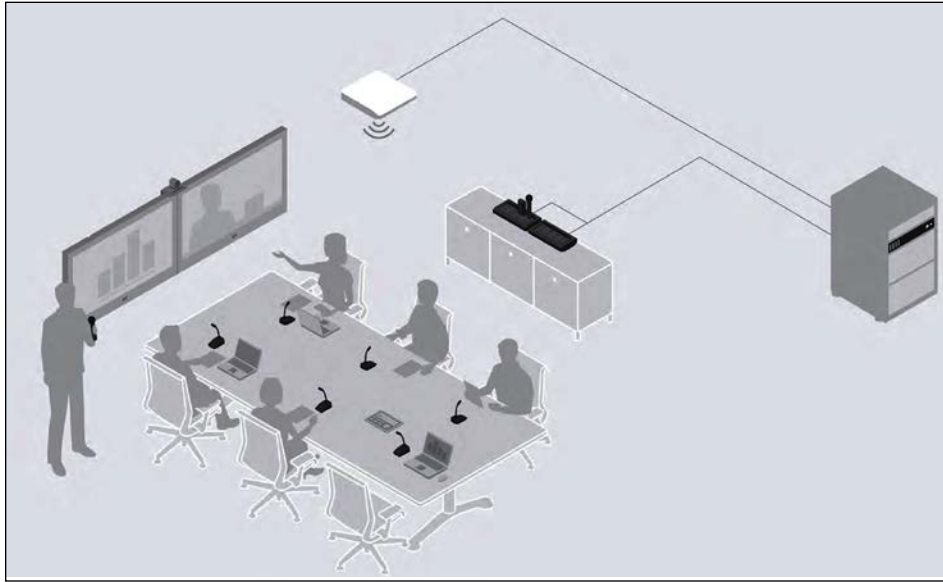

Microphone Transmitters

MXW microphones transmit an encrypted, wireless audio signal to the access point. Four form factors are available:

Hybrid Bodypack (MXW1)

The bodypack secures to a belt or strap for hands-free, mobile communication. It features a TQG input for lavalier connection and an integrated omnidirectional microphone.

Handheld (MXW2)

The handheld enables presenters to communicate using legendary Shure SM58, SM86, BETA58 and VP68 microphone cartridges.

Boundary (MXW6/C, MXW6/O)

The boundary transmitter sits on a table or desk to transmit speech while discreetly blending into any conference environment.

Desktop Gooseneck Base (MXW8)

The gooseneck base is compatible with 5, 10, and 15" Microflex gooseneck microphones.

The MXW1, MXW6, and MXW8 microphones include a headphone output for monitoring audio, such as a translation channel.

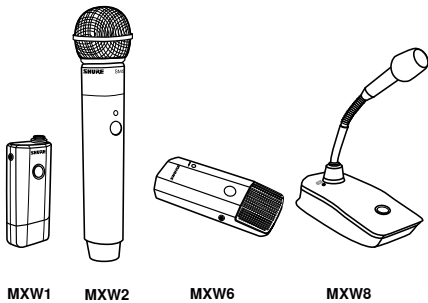

Access Point Transceiver (MXWAPT4, MXWAPT8)

The Access Point Transceiver (4 and 8 channel units) mounts to a wall or ceiling to manage encrypted, wireless audio connections with microphones. As a system hub, it transports digital audio between the wireless microphones and other Dante devices on the same network. The APT includes a webserver that hosts the MXW System control software, used for monitoring, configuration, and remote control of the system.



Networked Charging Station (MXWNCS4, MXWNCS8)

The Networked Charging Station (4 and 8 slot varieties) is capable of simultaneous charging up to 4 (or 8) MXW microphones. It also Links microphones to access point channels and networks battery statistics to the control software.

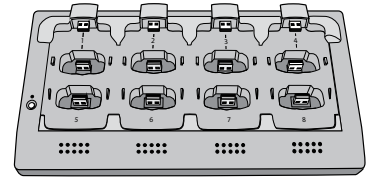

Important: Desktop Gooseneck Base Microphones (MXW8) occupy two charging slots. For example, eight MXW8 microphones require two MXWNCS8 charging stations (16 charging slots total).

Audio Network Interface (MXWANI4, MXWANI8)

The Audio Network Interface (4 and 8 channel) is a Dante network device that provides analog audio input and outputs for the MXW system. It has a 4-port Gigabit Ethernet switch that enables the connection of an MXW access point, a computer and up to two MXW networked charging stations.

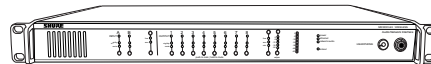

MXW Control Software

The MXW control software offers comprehensive remote control of key setup, monitoring and management functions. The software is accessible from any PC or Mac on the network, and opens in a web-browser using Adobe® Flash®.



Basic System Concepts

Forming Groups and Linking Microphones

Once all the MXW components are connected to the network, they can be associated into Groups from the Configuration tab of the control software. Each Access Point can form an association Group with one or two chargers (for Linking microphones) and one or two audio output devices (for routing audio to analog outputs). The microphones can then be placed in the charger and Linked to these access point channels.

Each Group is managed by a single access point. Microphones are Linked to channels in the access point, not to the charger that was used to Link them. This relationship persists until the microphones are re-Linked or the access point is reset.

Configurations: Managing Multiple Groups

Configurations allow multiple Groups to share the same preferences and global controls. When an additional Group is added to a Configuration page, a relationship is established across all devices in the configuration. The new Group will take on the settings of that configuration.

For specialized applications such as multiple room setup, several configurations can be created to independently control component Groups.

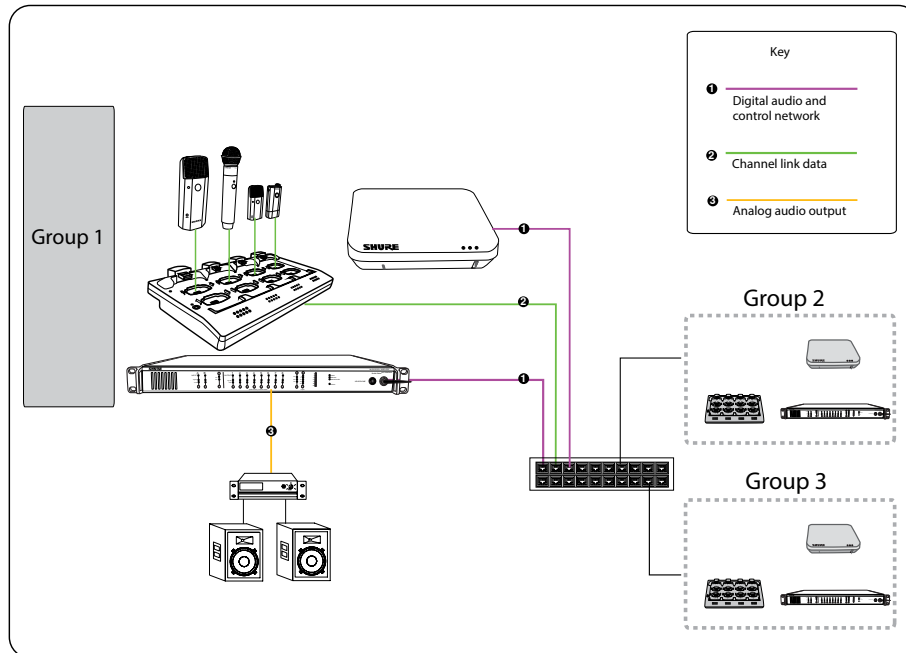

Technology Overview of the Audio Path

The MXW System combines Shure legendary audio quality with advanced digital networking technology. The following is an overview of the audio path:

Wireless Audio

The MXW transmitter converts speech into a digital signal that is transmitted wirelessly to the access point.

- Intelligent, automatic wireless audio management using the Digital Enhanced Cordless Telecommunications (DECT) framework
- Custom RF design enables higher audio quality and lower latency than most DECT systems

Digital Audio Network

The access point receives wireless audio from the microphones and distributes it to the audio network interface.

- Low latency, tight clock synchronization, and high Quality-of-Service (QoS) provide reliable audio transport.
- Digital audio is carried over Ethernet cables and standard IP equipment.
- Audio coexists safely on the same network as IT and control data, or can be configured to use a dedicated network.

Analog Audio

The audio network interface converts network audio for each channel into analog outputs.

- Sends analog audio to a mixer, Digital Signal Processor (DSP), or teleconferencing device.

Hardware Description

| | |
|--|-----------|
| ■ Audio Network Interface (ANI) | 10 |
| Front Panel | |
| Back Panel | |
| ■ Networked Charger (NCS) | 12 |
| Connecting Microphones | |
| ■ Microphone Transmitters | 13 |
| Description | |
| ■ Rechargeable Batteries | 16 |
| Using the MXW Networked Charging Station (NCS) | |
| USB Charger | |
| Battery Statistics on Control Software | |
| Battery Replacement | |
| ■ Additional Equipment | 19 |

Access Point Transceiver (APT)

The access point transceiver is the hub of the audio signal flow and manages the RF stability of each microphone in the group. The APT performs the following functions:

- Receives and decrypts wireless audio signals from microphones in the group
- Delivers the audio signal to the digital audio network and audio network interface (ANI)
- Hosts an embedded web server that provides access to the control software used to manage the MXW system
- Sends and receives control information (such as gain adjustment and link settings) between the components, MXW control software and 3rd party controllers.
- Transmits an encrypted audio signal to the microphone's headphone output for listening to translated audio or other external sources.

| | |
|---------|---------------------------|
| MXWAPT8 | Eight-channel transceiver |
| MXWAPT4 | Four-channel transceiver |

Directional Antennas

The access point contains multiple directional antennas to provide steady, reliable wireless communication with the microphones. It sends and receives the RF signal in a cardioid pattern with the greatest sensitivity toward the face of the device. Always aim this side toward the microphone coverage area.

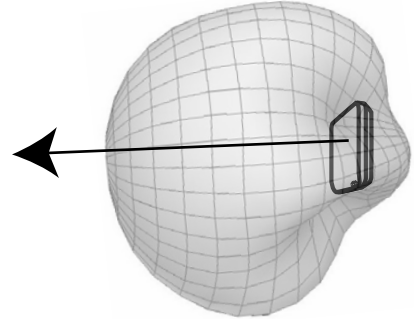

Cardioid RF Pattern

① Power LED

Illuminates green to indicate the presence of Power over Ethernet (PoE).

② Network Audio LED

| Color | Status |
|----------------|--|
| Green | All routed receive channels are OK (receiving digital audio as expected). |
| Flashing Green | <ul style="list-style-type: none"> - One or more connected receive channels experiencing a subscription error or is unresolved (transmitting device is off, disconnected, renamed or has incorrect network setting). - Receiving an Identification signal from the control software (simultaneous flash with Link Status LED). - The device is performing a spectrum scan (alternating flash with Link Status LED). - Clock synchronization problem. |
| Off | No receive channels connected (routing has not been established). |

Note: the network audio status can be monitored in detail from Dante Controller software.

③ Microphone Link Status LED

| Color | Status |
|--------------|---|
| Green | ≥1 microphone is linked and powered on in the Active, Mute or Standby state. |
| Off | ≥1 microphone is linked and is Off or in a non-networked charger. |
| Red | No microphones have been linked. |
| Flashing Red | <ul style="list-style-type: none"> - Receiving an Identification signal from the control software (simultaneous flash with Network Audio LED). - The device is performing a spectrum scan (alternating flash with Network Audio LED). |

④ Reset Button

Press and hold the reset button for 10 seconds to reset the MXW system to factory default settings.

Note: The reset deletes group association and microphone links, and will reboot the device in DHCP mode.

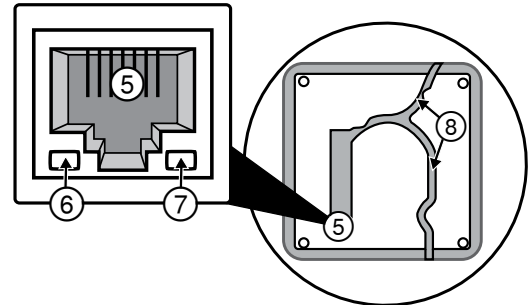
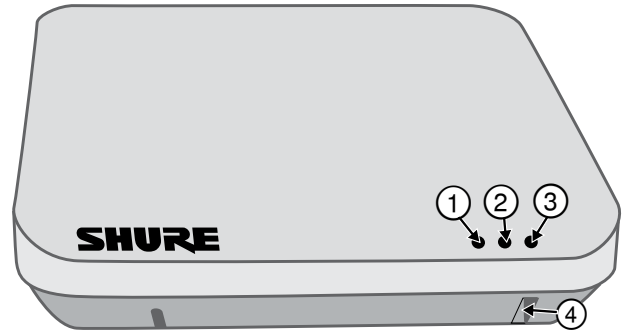

⑤ Ethernet Port

Connect a shielded Cat5e (or higher) cable to a PoE source and the network.

⑥ Ethernet Status LED (Green)

- Off = no network link
- On = network link established
- Flashing = network link active

⑦ Ethernet Link Speed LED (Amber)

- Off = 10/100 Mbps
- On = 1 Gbps (required for proper MXW functionality)

⑧ Cable Routing Path

Provides a path for the Ethernet cable to enable a flush-mount to the ceiling or wall.

Audio Network Interface (ANI)

The ANI performs the following functions:

- Converts digital audio from the network into analog audio to connect to a sound reinforcement system or recording device
- Four-port gigabit switch can connect an entire MXW system (up to eight channels) and power the MXW access point
- Provides analog input(s) to route audio to the microphones for personal monitoring.
- Front-panel interface provides status indicators and access to basic system controls.
- Hosts an embedded web server that provides an interface for monitoring and control of the device.

| | |
|---------|---|
| MXWANI8 | Eight channel outputs; two input channels |
| MXWANI4 | Four channel outputs; one input channel |

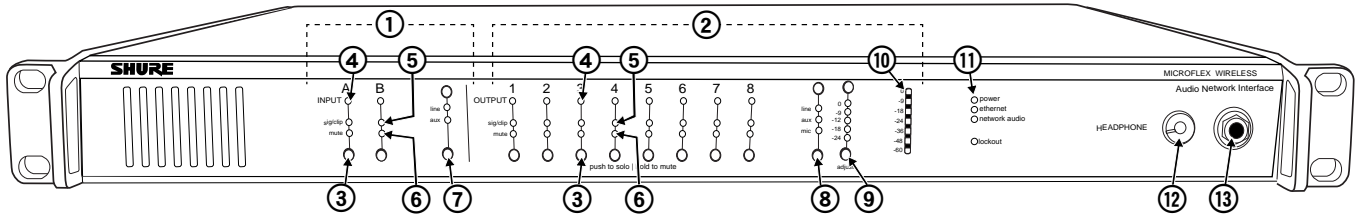

Front Panel

① Input Channels

Adds analog line- or aux-level signals to the digital network. When the device is associated to an MXW Group, inputs are automatically routed to Linked microphone channels (Input A to channels 1-4; Input B to 5-8).

② Output Channels

Converts digital network audio to an analog output for each channel. When associated to an MXW group, access point channels are automatically routed to the outputs of the ANI.

③ Channel Selector

Selects a channel to perform the following functions:

| Action | Function |
|----------------------------|---|
| Single Press | <ul style="list-style-type: none"> - Listen to that channel at the headphone jack - Display and adjust the channel output level and attenuation - Monitor output signal on the level meter |
| Press and Hold (3 seconds) | Mute/unmute a channel. Mute is indicated by the mute LED. |

④ Selected Channel LED

Illuminates when a channel is selected.

⑤ Signal Strength LED (sig/clip)

Indicates audio signal strength for each channel:

- Green = Normal
- Amber = Strong
- Red = Clipping (to eliminate clipping, attenuate the signal level at the audio source)

⑥ Mute LED

Illuminates red when the channel output is muted (hold its channel select button for 3 seconds). A muted channel is still routed to the HEADPHONE jack for monitoring or troubleshooting.

⑦ Input Level Selector

Set the selected channel to line- or aux-level to match the input signal.

⑧ Output Level Selector

Set the selected channel to an output level that matches the connecting device:

- line: +4 dBu
- aux: -10 dBV
- mic: -30 dBV

⑨ Output Attenuation Control

Use the up/down buttons to attenuate the channel output from 0 dB (no attenuation) to -24 dB in 1 dB increments, and from -24 to -78 in 3 dB increments.

⑩ Level Meter

Displays a selected channel's audio level in dBFS. It is good practice to use -18 dBFS on the output meter as an approximation of 0 VU on an analog meter.

⑪ Hardware Status LEDs

Indicate the status of the hardware:

| LED | Color | Status |
|---------------|----------------|---|
| Power | Green | Unit is powered on. |
| Ethernet | Green | Connected to an Ethernet device. |
| Network Audio | Green | All connected receive channels are OK (receiving digital audio as expected). |
| | Flashing Green | One or more connected receive channels experiencing a subscription error or is unresolved (transmitting device is off, disconnected, renamed or has incorrect network setting). |
| | Off | No receive channels connected (routing has not been established). |
| Lockout | Red | Front panel gain and mute controls are locked. The LED will blink when a button is pressed while the hardware is locked. |

⑫ Headphone Volume Knob

Adjusts the volume to the headphone output.

⑬ Headphone Output

1/4" (6.35 mm) output jack for monitoring audio going to and from the digital audio network.

Note: Audio is present only when the unit is connected to a digital audio network.

Back Panel

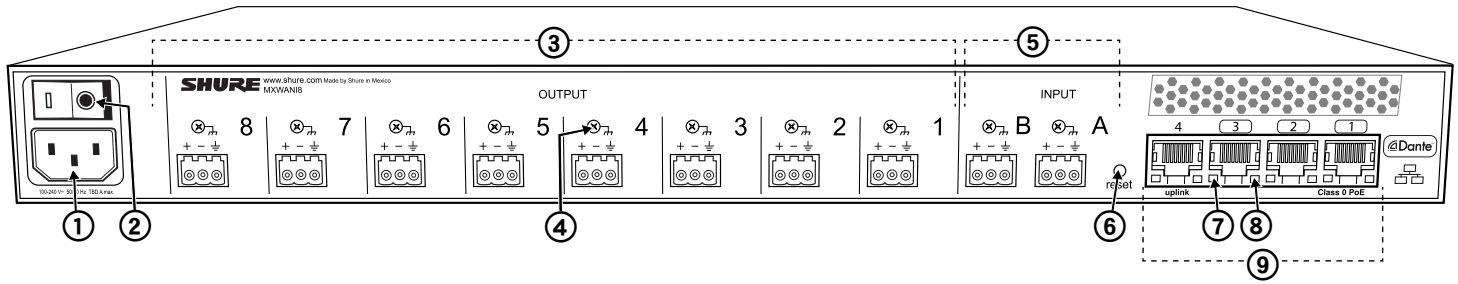

① AC Power

IEC connector 100 - 240 V AC.

② Power Switch

Powers the unit on or off.

③ Output Block Connectors (1-8)

Three-pin, low-voltage differential connector provides a line-, aux- or mic-level analog output for each channel.

④ Chassis Ground (1-8)

Use to directly ground the cable shield to the chassis.

⑤ Input Block Connectors (A,B)

Three-pin, low-voltage differential input connector adds line- or aux-level analog signals to the digital network.

Note: This input is meant for balanced connection. If an unbalanced source is used, such as an IPOD or MP3 player, only use pins 1 (signal) and 3 (ground) of the block connector. See Specifications sections for wiring diagrams.

⑥ Reset Button

Press and hold the button for five seconds to reboot the device with factory default settings.

⑦ Ethernet Status LED (Green)

- Off = no network link
- On = network link established
- Flashing = network link active

⑧ Ethernet Link Speed LED (Amber)

- Off = 10/100 Mbps
- On = 1 Gbps (required for digital audio routing)

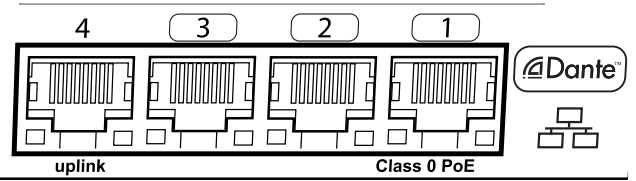

⑨ Network Interface

Four-port gigabit switch for connecting components together for a single MXW Group, or for connecting multiple devices to a larger digital audio network. The following is a description of each port:

| Port | Description |
|-----------------|--|
| Port 1 (PoE) | Provides Power over Ethernet (PoE) for the Shure access point and functions as a standard gigabit port. |
| Ports 2 and 3 | Standard gigabit ports enable the connection of another MXW network, additional MXWANIs, a MXWNCS charging stations or an external control system. |
| Port 4 (Uplink) | <ul style="list-style-type: none"> - Normal mode (default): this port functions the same as ports 2 and 3. - Uplink Mode: only transports control data. This mode blocks network audio and data for Shure Web Discovery Application, Dante Controller and Dante Virtual Soundcard. |

Networked Charger (NCS)

The MXW networked charging station enables battery charging and channel linking from a single location. When a charger is associated to a group, its channel slots are mapped to access point audio channels. Microphones can then be placed in the slots to Link to these channels.

Any microphone can recharge in any NCS, regardless of Group association or network connection. **Caution:** When the Link button on an associated charger is pressed, all microphones in the charger will be mapped to channels on an access point. This will override any previously Linked microphones on those channels.

| | |
|---------|--|
| MXWNCS8 | Accepts eight boundary, bodypack, or handheld microphones; or four gooseneck bases |
| MXWNCS4 | Accepts four boundary, bodypack, or handheld microphones; or two gooseneck bases |

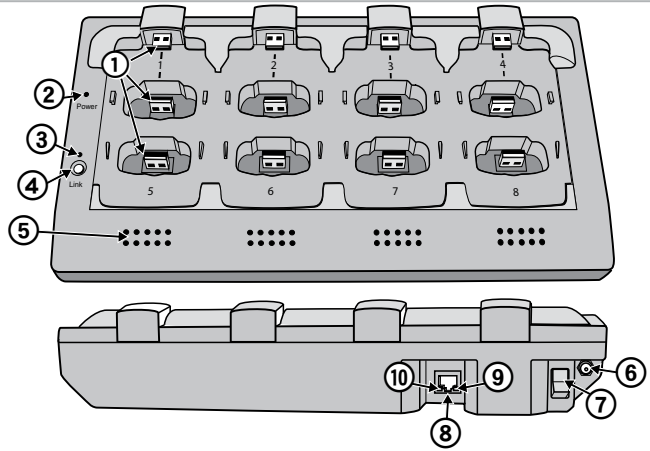

① Charging Slots (USB 3.0 Type A)

Recharge and link microphones by connecting them to the USB slots on the charger. When the charger is associated to a group, the slots are mapped to access point channels (See Audio Channel Assignment for details).

Note: Any microphone can charge in any charger, regardless of Group association or network connection.

② Power LED

Illuminates green when the unit is powered on.

③ Microphone Link LED

Indicates the status of the Linking procedure:

| Color | Indicator |
|----------------|--|
| Off (default) | No Link has been initiated. |
| Flashing Green | Link procedure is in process. |
| Green | Microphones have been successfully linked to channels. |
| Red | Link procedure unsuccessful (RF issue, network failure, or microphones removed during procedure) |
| Amber | Link procedure cannot start because the station is not associated to a group. |
| Flashing Red | Link procedure has been locked from the control software. |

④ Microphone Link Button

Press and hold for 6 seconds to link all microphones in the charger to channels of the associated Access Point Transceiver.

⑤ Battery Status LEDs

Monitors the charge status of the connected microphone in increments of <10, 10, 25, 50, 75, 100% (see Batteries for more detail). Additionally, the five LEDs flash for several seconds when a the channel has been successfully Linked to a microphone.

⑥ Locking DC Power Supply

Secures the PS45 power supply to the input jack of the station.

⑦ Power Switch

Powers the unit on or off.

⑧ Ethernet Port

Connects to the MXW System network through an MXW Audio Network Interface or a switch using an Ethernet cable.

⑨ Ethernet Status LED (Green)

- Off = no network link.
- On = network link established.
- Flashing = network link active.

⑩ Ethernet Link Speed LED (Amber)

- Off = 10 Mbps
- On = 100 Mbps

Connecting Microphones

Place a microphone in the charger by connecting it to one of the channel slots. The channels in the top row have two USB ports to accommodate different types of microphones. Do not attempt to connect to both USB ports at the same time.

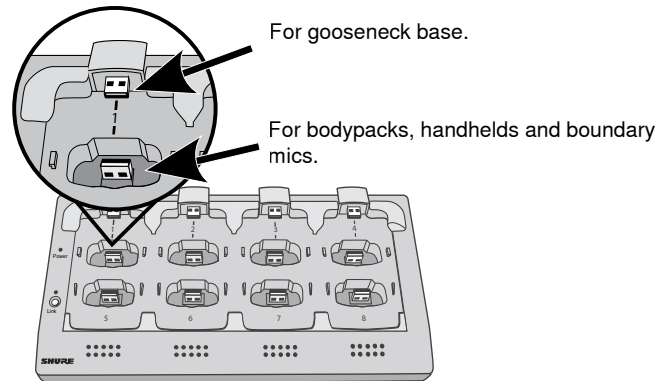
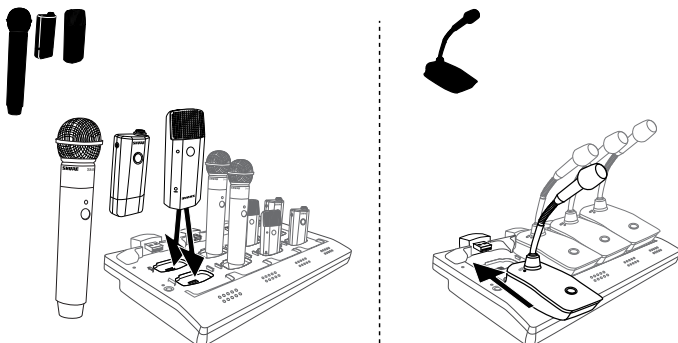

Different Connectors for the Same Channel

Microphone Transmitters

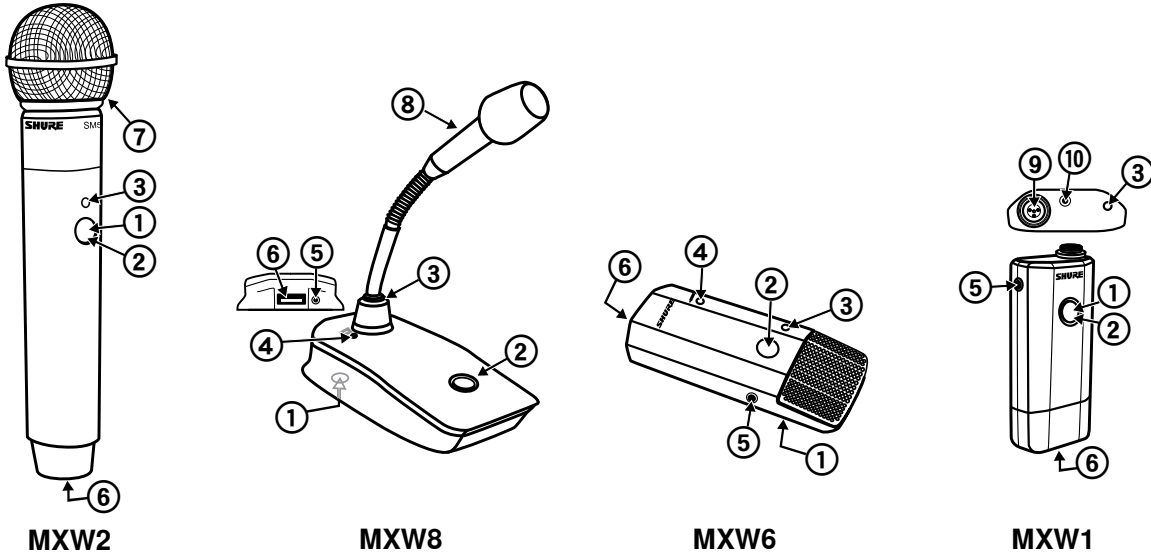

Description

① Power Button

MXW6, MXW8: Press and hold the dedicated power button for three seconds to turn the transmitter on or off.

MXW1, MXW2: Press and hold the Mute/Active button for five seconds to turn the transmitter on or off.

② Mute/Active Button

Changes the audio status from Active to Mute, or Mute to Active. The button behavior for each transmitter type can be set independently from the Preferences tab. The following describes the function of each setting:

- **Toggle:** Press and release the button to change the status to Active or Mute.
- **Push-to-talk:** Hold button to pass audio.
- **Push-to-mute:** Hold button to mute the audio.
- **Disabled:** The button does not affect the audio.

③ Status LED

Indicates the transmitter's status. The color indicators for Mute and Active can be customized from the Preferences tab. See the Status LED table for the default LED behavior for MXW transmitters except the gooseneck light-ring models (MX405R/410R/415R).

④ Low Battery LED (Gooseneck and Boundary only)

| Color | Status |
|-----------|-----------------------------|
| Off | <5% battery runtime remains |
| Solid Red | >5% battery runtime remains |

⑤ Earphone Jack

1/8" (3.5 mm) jack for monitoring a return channel signal, such as translated audio. This audio is automatically routed from the input(s) of the Audio Network Interface (Input A to channels 1 - 4; Input B to channels 5 - 8).

Note: Not featured on the MXW2 handheld transmitter.

⑥ Charge Connector (USB 3.0 Type A)

Connects to the NCS charger slot or to the USB Charger.

⑦ Handheld Cartridge

MXW2 transmitter is compatible with the following cartridge types: SM58, Beta 58, SM86, VP68.

⑧ Gooseneck Microphone

The gooseneck base is compatible with 5, 10, and 15" Microflex gooseneck microphones.

⑨ TQG Connector

The MXW hybrid bodypack has a TQG connector for an external lavalier or headset microphone.

⑩ Internal Microphone

The bodypack transmitter has an internal, omnidirectional microphone that can be set to automatically engage when not connected to a lavalier microphone.

Status LED Table

| Status | LED | Description |
|--------------------------|--------------------------|--|
| Active | Green | Ready to pass audio to network. |
| Mute | Red | Audio is muted. |
| Standby | Red Pulsing (slow flash) | Audio is muted and the transmitter is in a hibernation state to conserve the battery. |
| Identify | Flashing Yellow | The Identify button has been pressed from the control software. |
| Out of RF Coverage Range | Red Pulsing (fast flash) | The transmitter is out of the RF coverage range to the linked access point. |
| Charging | Off | The transmitter is charging. |
| Off | Off | No connection to the network. The transmitter must be turned on using the power button on the mic. |

Microphone Transmitters

MXW microphones transmit an encrypted, wireless audio signal to the access point. Four form factors are available:

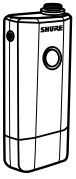

Hybrid Bodypack (MXW1)

The bodypack secures to a belt or strap for hands-free, mobile communication. It features a TQG input for lavalier connection and an integrated omnidirectional microphone.

Wearing the Bodypack Transmitter

- Clip the transmitter to a belt or pocket.
- For best results, the belt should be pressed against the base of the clip.

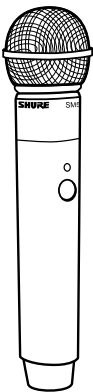
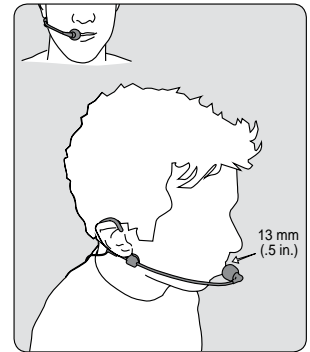
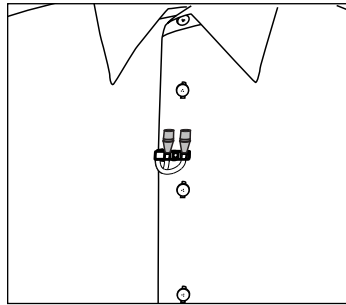
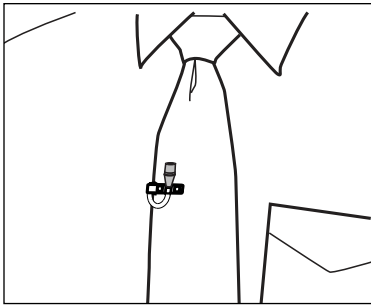
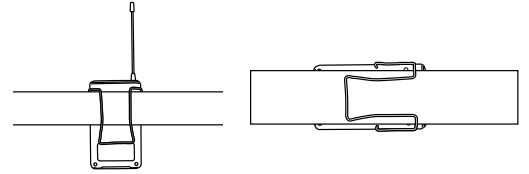

Handheld (MXW2)

The handheld enables presenters to communicate using legendary Shure SM58, SM86, BETA58 and VP68 microphone cartridges.

Correct Microphone Placement

- Hold the microphone within 12 inches from the sound source. For a warmer sound with increased bass presence, move the microphone closer.
- Do not cover grille with hand.

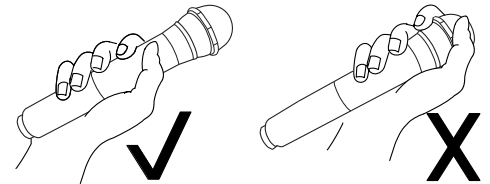

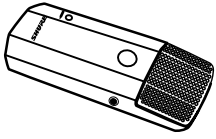

Boundary (MXW6/C, MXW6/O)

The boundary transmitter sits on a table or desk to transmit speech while discreetly blending into any conference environment.

MXW6/O

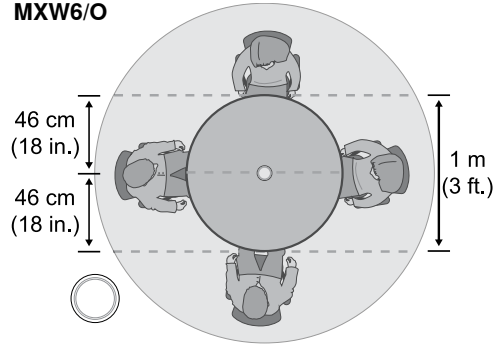

MXW6/C

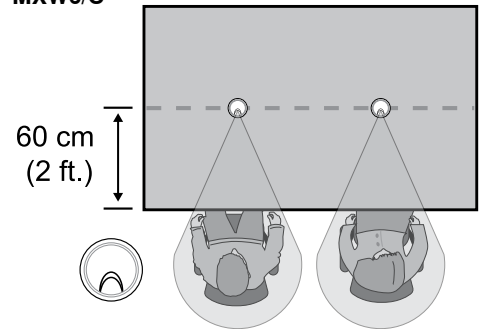

Microphone Placement

For best low-frequency response and rejection of background noise, place the microphone on a large, flat surface, such as a floor, table, or lectern.

To reduce reverberance, avoid reflective surfaces above or to the side of the microphone, such as beveled sides of pulpits or overhanging shelves.

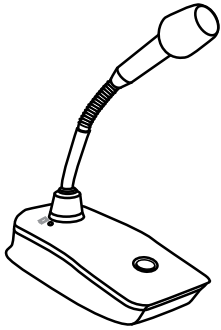

Desktop Gooseneck Base (MXW8)

The gooseneck base is compatible with 5, 10, and 15" Microflex gooseneck microphones.

The MXW1, MXW6, and MXW8 microphones include a headphone output for monitoring audio, such as a translation channel.

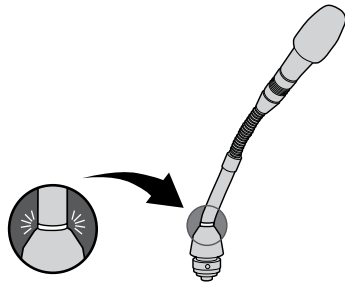
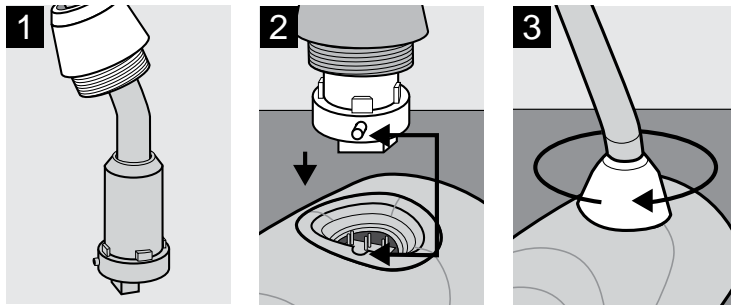

MXW lithium-ion rechargeable batteries use advanced chemistry that maximizes

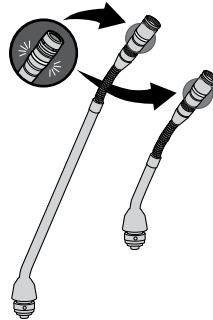

transmitter runtime with zero-memory effect. Power management from the control software provides

detailed visibility to critical battery parameters such as charge status, battery capacity, and cycle count. Batteries can be charged to 50% capacity in one hour and to full capacity in two hours using the MXW Networked Charging Station. The SB901 battery powers the bodypack, boundary and gooseneck transmitters; the SB902 battery powers the handheld transmitter.

Using the MXW Networked Charging Station (NCS)

Slide the transmitter into the charging slot until it secures into place. The charge LEDs illuminate and the charge cycle begins. Regardless of Group association or network connection, any microphone can recharge in any NCS.

- Handheld, boundary and bodypack: use the main vertical slots in the recessed bays.
- Gooseneck base: uses the top row's horizontal connectors.

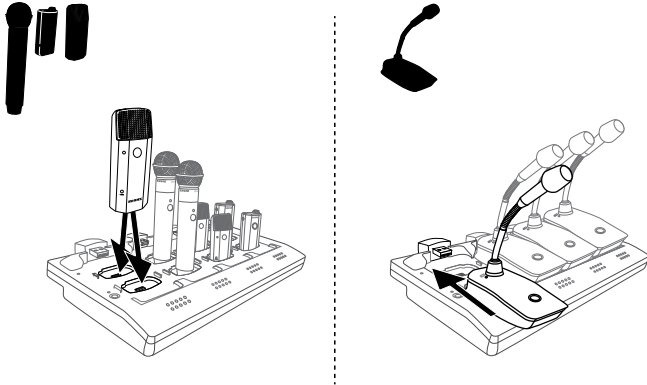

Charge Status LEDs

Each charger slot has a row of LEDs that illuminate to indicate the status of the connected transmitter's battery charge:

| LED | | % Battery Charge |
|-----|----------|------------------|
| 1 | Flashing | <10% |
| | Solid | >10% |
| 2 | | >25% |
| 3 | | >50% |
| 4 | | >75% |
| 5 | | >95% |

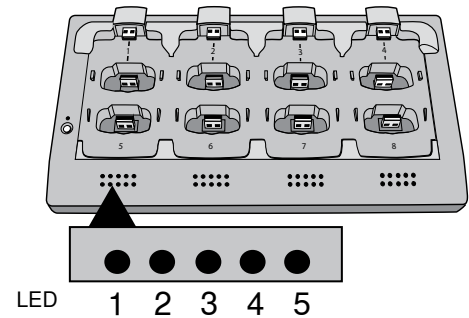

USB Charger

The USB Charger (SBC-USB) can connect to an MXW transmitter to provide power during operation.

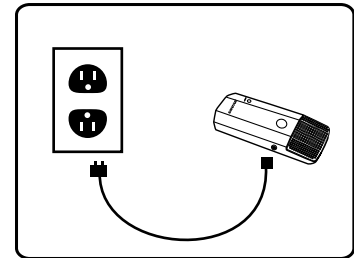

Battery Statistics on Control Software

The MXW control software is used to manage battery information. Use the Monitor tab to view battery charging status:



Monitoring Battery Charge Status

In the Charging Station: Displays the remaining time until the microphone battery is fully charged.

During Use: Displays the remaining battery runtime of the microphone.

For battery health statistics, use the Utility tab:

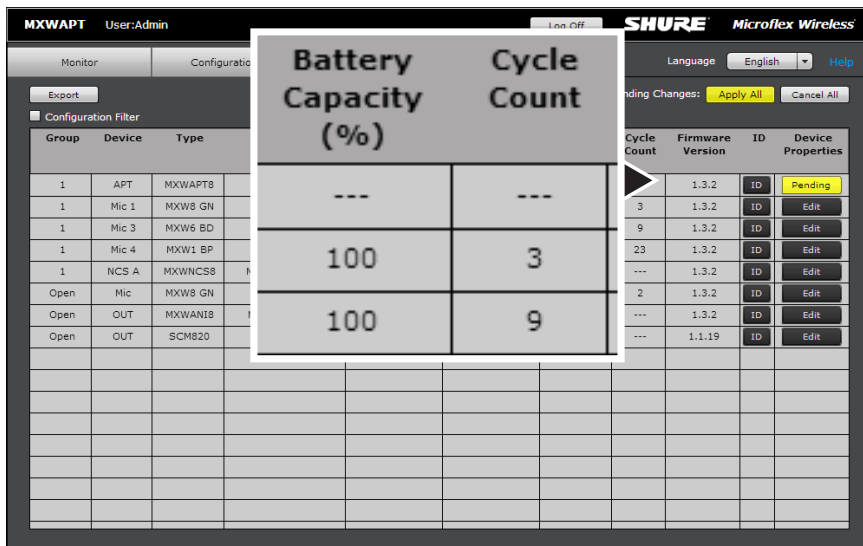

Battery Statistics

Battery Capacity: The microphone battery's percentage of charge capacity as compared to a new battery.

Cycle Count: Number of charge cycles logged by the battery.

Battery Replacement

Lithium Ion Batteries have no "memory effect", and instead experience a more linear reduction in capacity. Shure recommends establishing a battery replacement schedule customized to the client requirements and replacing batteries when the capacity is no longer acceptable.

MXW1, MXW6, MXW8 Battery Replacement

1. Unscrew and open the battery door on the bottom of the transmitter.
2. Remove battery by gently disconnecting the battery connector from the transmitter.
3. Connect the replacement battery's connector to the transmitter.
4. Replace the battery with the label facing out.
5. Close the door and tighten the screw.
6. Dispose of batteries properly. Check with your local vendor for proper disposal of used batteries.

MXW2 Battery Replacement

1. Unscrew the two screws at the bottom of the transmitter handle.
2. Unscrew and remove the microphone head.
3. Remove the retention clip and gently pull out the battery frame.
4. Unscrew the three screws that fasten the battery door to the frame. Remove the battery door.
5. Replace the old battery with a new one.
6. Replace the battery door and tighten the screws.
7. Gently slide the battery frame back into the transmitter.
8. Replace the retention clip to secure the battery frame in the transmitter.
9. Replace the microphone head. Make sure it is secure.
10. Replace the two screws on the bottom of the transmitter handle.
11. Dispose of batteries properly. Check with your local vendor for proper disposal of used batteries.

Installation

| | |
|--|-----------|
| ■ Rack Installation | 19 |
| ■ Securing the Networked Charging Station | 19 |
| Required Equipment | |
| Installation Steps | |
| ■ Mount the Access Point Transceiver | 20 |
| Select a Location | |
| Securing to a Wall or Ceiling | |
| External Cover for Painting | |
| ■ Power the Hardware | 21 |
| Fully Charge the Transmitters | |
| ■ Connect the Components | 22 |
| Single Group System (1 Access Point) | |
| Multiple Group System (>1 Access Point) | |
| Local System Star Setup | |
| ■ Accessing the MXW Control Software | 23 |
| Operating System Requirements | |

Additional Equipment

Network Cables

Use shielded Cat5e (or higher) Ethernet cables, limiting cable runs to 100 meters maximum between network devices.

Audio Cables

Reference the hardware kit user guide supplied with the MXW Audio Network Interface to assemble audio cables to the connectors.

Gigabit DHCP Router (systems with >1 APT)

For systems with more than one APT, a DHCP router is recommended to connect equipment. Ensure that it meets the following requirements:

- Gigabit ports
- Provides Class 0 PoE with at least 6.5W (for powering the MXWAPT)
- Quality of Service (QoS) with 4 queues
- Diffserv (DSCP) QoS, with strict priority
- If the router features Energy Efficient Ethernet (or Green Ethernet), ensure it is disabled from the ports dedicated for the MXW system.
- Recommended: A managed switch to provide detailed information about the operation of each network link: port speed, error counters, bandwidth used, etc.

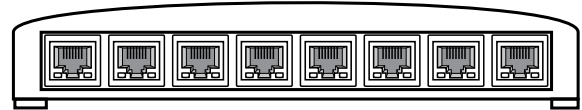
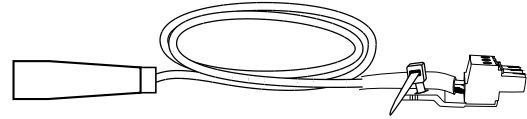

Rack Installation

Rackmount the device using the screws and washers supplied in the Hardware Kit. Follow these general best practices when installing equipment in a rack:

- Ambient temperature of the rack should not exceed specified operating temperature range of the device.
- Keep fan inlet and side air vents clear from obstructions and provide adequate space for airflow within the rack.
- When possible, provide 1 RU of empty space between each device.

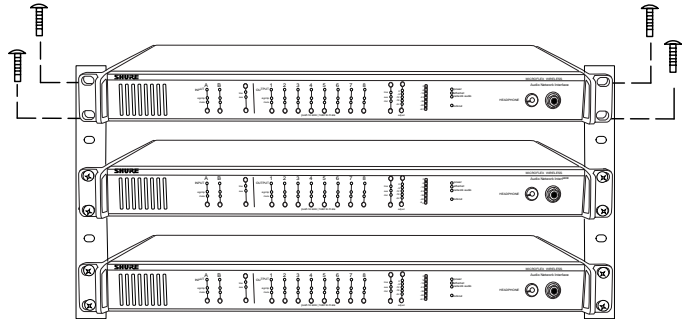

Securing the Networked Charging Station

The Network Charging Station can be secured to a surface using the holes on the bottom of the device. Reference the NCS Mounting Template for measuring and drilling holes. The following is a list of best practices for securing the charging station:

Required Equipment

- Two #10-32 screws at appropriate length*
- Two #10 flat washers
- Two #10 split lock washers

*Screw Length = Table thickness + thread engagement (4.75 mm max.) + thickness of flat washer + the thickness of the split lock washer

Installation Steps

1. Reference the template and mark location of holes
2. Drill holes into the mounting surface
3. Connect the Ethernet and power cable to the charging station
4. Place the charger and screw the #10-32 screws into the table and charging station. (CAUTION: Do not over-tighten screws, as this could cause permanent damage to the charging station.)

Mount the Access Point Transceiver

The directional antennas of the APT send and receive the RF signal in a cardioid pattern with the greatest sensitivity toward the face of the device. Always aim this side toward the microphone coverage area.

Select a Location

The access point is typically mounted to a ceiling or wall near the microphone coverage area. For best results, perform a Spectrum Scan at potential locations to find the optimal placement (see Wireless Management section for more details).

Use the following best-practices when selecting a location for the device:

- Direct the face of the access point toward the intended coverage area.
- Position the access point so there is nothing obstructing a line of sight to the microphones.
- Keep device away from large metal objects.
- Keep at least eight feet between access points.
- Mount with its reset button accessible, as it may be useful for troubleshooting.

Important: Always perform a "walk around" test to verify coverage before using a wireless system during a speech or performance. Experiment with antenna placement to find the optimum location. If necessary, mark "trouble spots" and ask presenters or performers to avoid those areas.

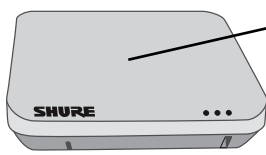
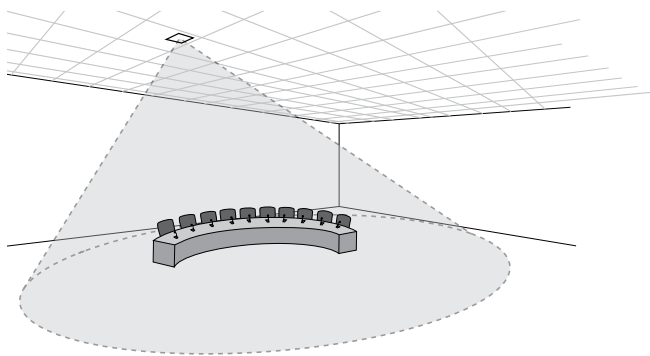

Mount with this side facing the microphones

Cardioid RF Pattern

Securing to a Wall or Ceiling

Required Equipment

- Two #8 screws at appropriate length*

*Screw Length = Surface thickness + thread engagement (4.75 mm max.) + thickness of flat washer + the thickness of the split lock washer

Installation Steps

1. Use the mounting plate as a template and mark the location for the holes.
2. Drill the holes into the mounting surface.
3. Secure mounting plate to the surface (CAUTION: Do not over-tighten screws, as this could cause permanent damage to the charging station).
4. Connect of the Ethernet cable to the MXWAPT using the cable route path.
5. Position the MXWAPT over the keyway slots of the mounting plate and slide it down into the locked position.

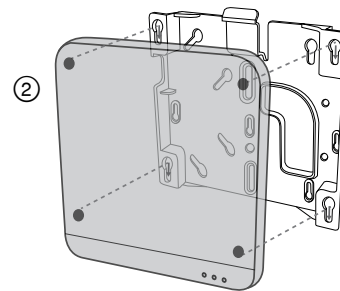
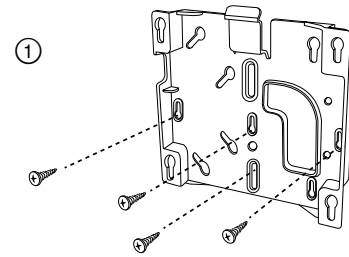

External Cover for Painting

The Access Point is supplied with an external cover that can be painted to match the decor of the installation. After it has been painted and dried, it snaps onto the front plate of the device.

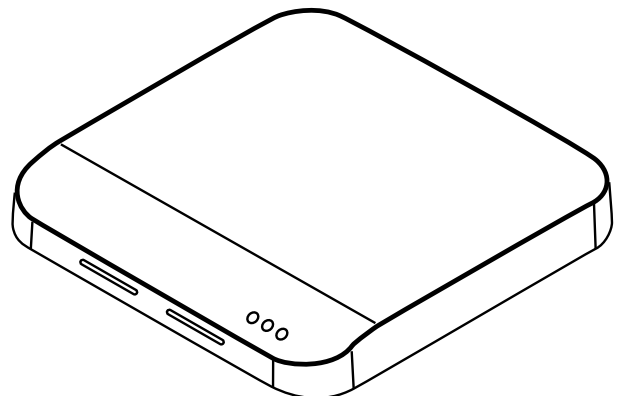

Power the Hardware

① Audio Network Interface (ANI)

Connect the IEC power cable from the back panel to an AC power source. Turn on the power switch.

② Access Point Transceiver (APT)

Connect a shielded Cat5e cable from the MXWAPT to network Port 1 of the MXWANI. If using an external gigabit switch, ensure Class 0 PoE provides at least 6.5W of power to the APT. There is no power switch.

③ Networked Charging Station (NCS)

Connect the PS45 external power supply from the charger to an AC power source. Turn on the power switch.

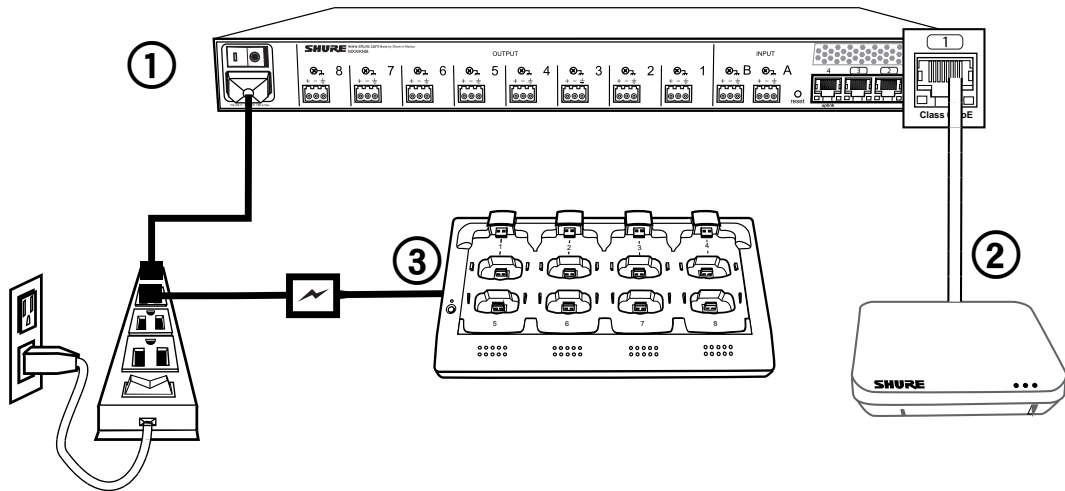

Fully Charge the Transmitters

Whenever possible, charge to full the MXW transmitters before an event. Transmitters can be charged in **any** networked charging station, even if it is associated to another Group or on a separate network.

Battery Charge Times

Approximate Charge Times

| Charger Type | Time to Full Charge* (hr:min) |
|----------------------------------|---|
| Networked Charging Station (NCS) | 2:00 |
| USB Charger | <ul style="list-style-type: none"> Powered On = 3:30 Powered Off = 2:30 |

*Calculated with a new battery. Runtimes vary depending on battery health.

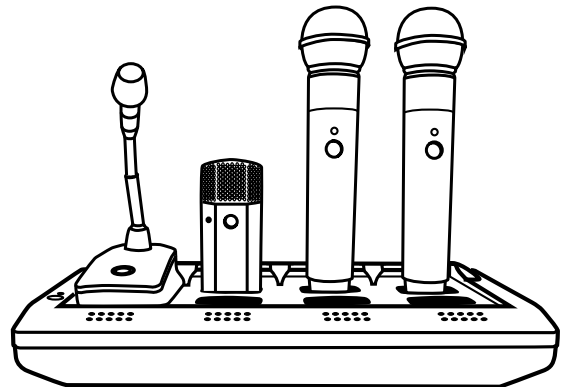

Connect the Components

MXW components are connected using Ethernet cables and a switch. For a small system with a single access point, the MXW Audio Network Interface functions as the switch. For systems with more than one access point, an additional gigabit switch is required for connecting all the components together.

Requirements:

- Use shielded Cat 5e (or higher) Ethernet cables. Limit cable runs to ≤ 100 m between devices.
- Use Gigabit networking equipment between network audio devices (required for systems with >1 access point).
- Ensure MXW components are on the same firmware version.
- Ensure MXW components and the PC are on the same network and set to the same subnet.

Single Group System (1 Access Point)

When the system is limited to a single group (up to eight channels), use the MXW Audio Network Interface four-port switch for connecting MXW components. Connect the computer, access point and up to two chargers to the MXW interface according to the table and diagram:

| Audio Network Interface Port | To Component |
|------------------------------|----------------------------------|
| ① Port 1 (PoE) | Access Point Transceiver (APT) |
| ② Port 2 | Networked Charging Station (NCS) |
| ③ Port 3 | (Optional) Additional NCS |
| ④ Port 4* | Computer |

*When Port 4 is set to Uplink mode, Shure Discovery Application support is restricted.

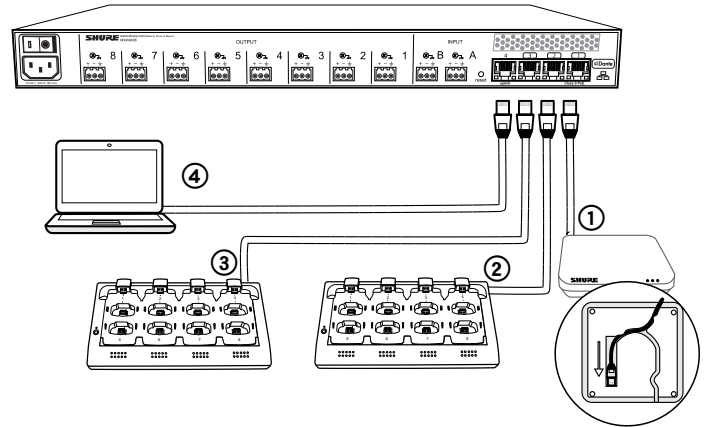

Multiple Group System (>1 Access Point)

When an installation requires more than eight channels, additional MXW components can be connected to expand the system. A gigabit router is required to connect all components to the same network. The following are several topologies for multiple group systems.

Use the Spectrum Scanner to ensure that there is sufficient RF availability for the installation.

Large Single-Room Installation

1. Power on the DHCP-enabled router.
2. Connect the router to a computer.
3. Connect each APT to a Power over Ethernet (PoE)-enabled port on the router. Use a PoE inserter if the router does not provide it.
4. Connect each ANI to the router.
5. Connect chargers to the ANI ports, or to the router.

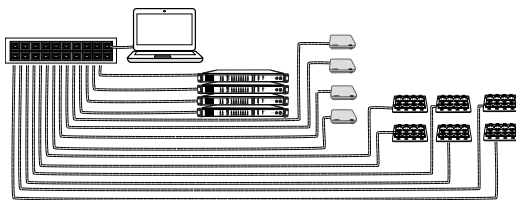

Star Configuration (recommended)

Local System Star Setup

To minimize cabling, MXW components can use the Audio Network Interface as a local switch that connects to a shared network.

1. Power on the DHCP-enabled router.
2. Connect the router to a computer.
3. Connect the router to Port 2, 3, or 4 on the Audio Network Interface
4. Connect the Access Point Transceiver to the Port 1 of the Audio Network Interface.
5. Connect the Network Charging Station(s) to an open port(s) on the Audio Network Interface.
6. Repeat steps 2 - 4 for additional equipment.

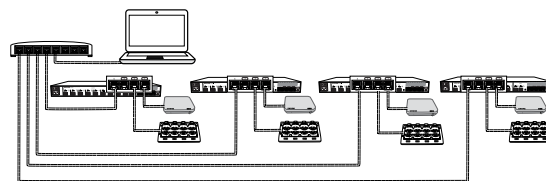

Local System Star to Network (minimal cabling)

Accessing the MXW Control Software

The MXW system uses a device-hosted control software that enables comprehensive remote control of key setup, monitoring and management functions. The software is accessible from any PC or Mac on the network, and opens in a web-browser using Adobe® Flash®.

There are two different control interfaces for the MXW system:

- MXW System control software: Accessed from the Access Point Transceiver and used for managing the MXW system.
- Audio Network Interface control software: Accessed from the Audio Network Interface and used for managing that device only.

Follow these steps for accessing MXW control software:

1. Install the Shure Web Device Discovery application.

Download the Shure Web Device Discovery Application from www.shure.com or from the USB stick supplied with the MXW Access Point Transceiver. (The required Bonjour device discovery tool is bundled with the application and will install automatically.)

2. Ensure the computer is on the MXW network.

The computer accesses the control software from an embedded web server on the device. All networked devices must be connected to the same network (set to the same subnet).

3. Turn off WiFi

Turn off the PC's WiFi to force the wired network interface.

4. Launch the Shure Web Device Discovery application.

Open the application to view all Shure devices on the network that feature an embedded server for control software (MXWAPT, MXWANI and SCM820). Use the Identify button to flash a device's LEDs for easy identification.

5. Open the MXW Control Software

Double-click on any Access Point Transceiver to open the MXW System control software. Double click on an Audio Network Interface to open that device's software interface. The application can open the Control Software by IP address or DNS name (selectable from the Preferences drop-down).

6. Enter Default Password

Enter the default password 'admin' to access the control software.

7. Bookmark the Webpage (recommended)

Bookmark the IP address of the device when it is set to a Static IP address. Bookmark the device's DNS name when the IP mode is set to Automatic (DHCP).

Operating System Requirements

To operate the control software, the computer must meet the following requirements:

- Windows: Windows XP, Windows Vista and Windows 7
- Apple: Mac OSX 10.6 and higher (Intel Core 2 Duo processor and later)
- Latest version of Adobe® Flash® Player

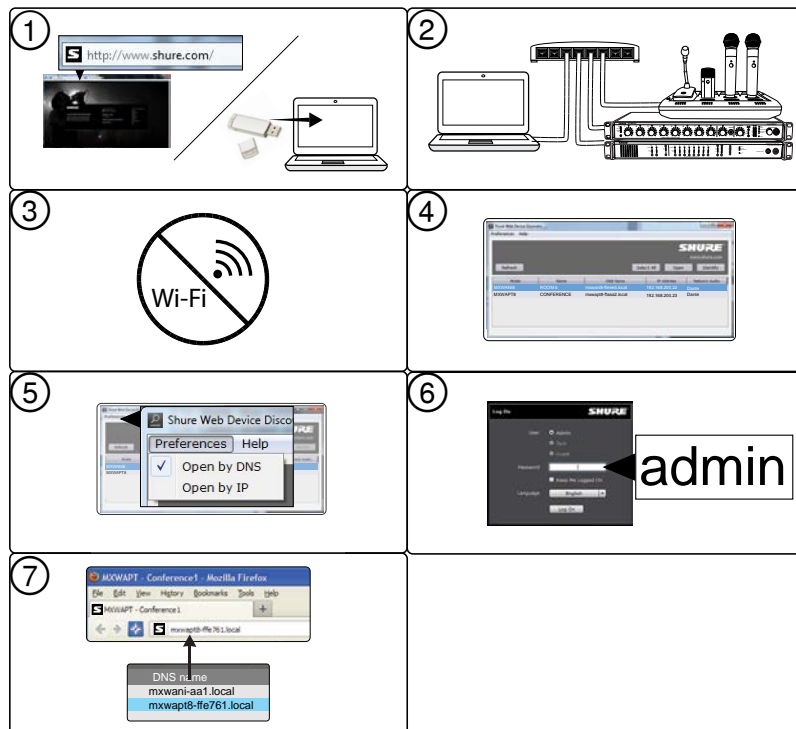

Setting Up the System

- **Overview of Groups and Configurations** **25**
 - Groups of Components
 - Configurations: Managing Multiple Groups
- **Associating Components to a Group** **26**
 - Channel Mapping for Devices in a Group
 - Automatic Group Setup
- **Linking Microphones** **28**
- **Creating Separate Configurations** **29**
 - Device Availability
- **Exchanging or Removing a Component** **30**
 - Exchanging a Transmitter
 - Remove a Device from a Group

Overview of Groups and Configurations

Groups of Components

Once all the MXW components are connected to the network, they can be associated into Groups. Each Access Point Transceiver (APT) can form a Group with one or two chargers (for Linking microphones) and one or two audio output devices (for routing audio to analog outputs). The microphones can then be placed in the charging station and Linked to these access point channels.

Each Group is managed by a single access point. Microphones are Linked to channels in the access point, not to the charger that was used to Link them. This relationship persists until the microphones are re-Linked or the access point is reset.

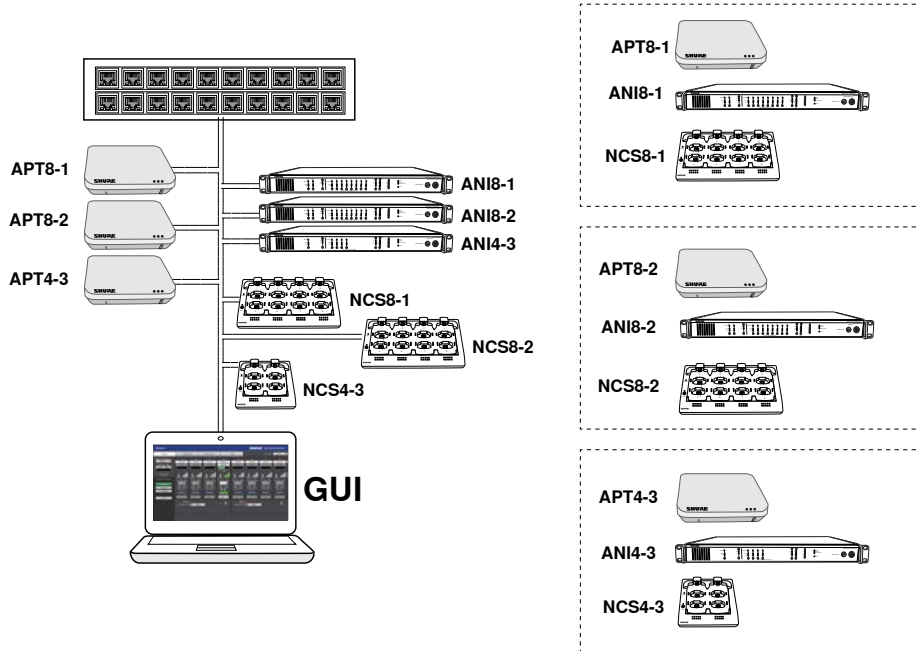

Components are connected to the same network (set to same subnet) to expand the MXW system.

Each component is associated to an MXW Access Point Transceiver to form the group.

A Network of Groups

Configurations: Managing Multiple Groups

Configurations allow multiple Groups to share the same preferences, global controls and log-ons. When an additional Group is added to the Configuration tab, the new components will take on the preferences and global actions of that Configuration. For example, all microphones Linked to Groups in that Configuration will mute when the global Mute All button is pressed.

For specialized applications, such as multiple room installation, separate Configurations can be created to independently control component Groups.

Configuration Master

When using a Configuration to manage multiple groups, the system dynamically assigns a particular Access Point as the "Configuration Master". All Access Points in that Configuration use the Configuration Master Access Point as an entry point to the same control interface. This enables the coordination of preferences and the synchronization of system operations across multiple devices.

When the Configuration Master Access Point is unplugged (or PoE is powered off), a new master is quickly re-established to maintain control of the Configuration. If the Configuration Master is manually removed by deselecting the Access Point from the Group on the Configuration tab, there will be a pop-up warning "Are You Sure?". If Yes is selected, the browser will close and a new Configuration Master is automatically selected. Use the Shure Discovery Application to re-open the control interface from any remaining MXW Access Point.

Associating Components to a Group

The following instructions are for forming an MXW Group. If a device is not available from drop-down window, make sure it is "open" and on the network.

Note: Device associations and microphone Link data are persistently stored in the device. If the MXW system is shut off and then restarted without a computer, the devices will remain associated to the access point.

Tip: Use the **ID** button to identify a device. This sends a signal to the device to flash its LEDs for easy identification.

1. Open a Configuration

Use the Shure Web Discovery application to view all MXW Access Point Transceivers (APTs) on the network. Double-click on an APT to open the software, and go to the Configuration tab.

2. Select an Access Point Transceiver (APT) for Group 1

Select an open APT from the drop-down display. This selection determines whether the Group has four or eight channels (APT4 or APT8).

Note: Group 1 must include the APT that was used to open the control software. Other networked (and open) APTs are then available for additional groups.

3. Select the Network Charging Station(s)

Associate one or two Network Charging Station (NCS) to the access point. There are two reasons for associating more than one charger:

- When using two four-channel chargers for an eight-channel access point.
- When using gooseneck microphones. Gooseneck mics cover the front and back slots of a charger, halving the number of slots available. For example, two eight-channel chargers are required to fill an eight-channel access point with gooseneck microphones.

4. Select the Audio Output Device(s)

Select one or two audio output devices (MXWANI or SCM820) to automatically route the digital audio channels from the access point. Select from the following devices:

- Audio Network Interface (MXWANI) four- or eight-channel variation. Two four-channel units or one eight-channel unit can be assigned to an eight-channel APT.
- Shure SCM820 IntelliMix® Mixer. Dante-enabled SCM820s can be selected as the audio output for the Group. This automatically routes the SCM820's aux input to the microphones for personal monitoring (SCM820 aux left channel to MXW channels 1 - 4; aux right channel to MXW channels 5 - 8).

5. Repeat for Additional Groups and Lock the Configuration

Repeat steps 2 - 4 for up to 10 groups per configuration. When finished with the configuration setup, select the Lock Configuration button to improve network performance and system stability. When locked, groups in that configuration are not editable.

1

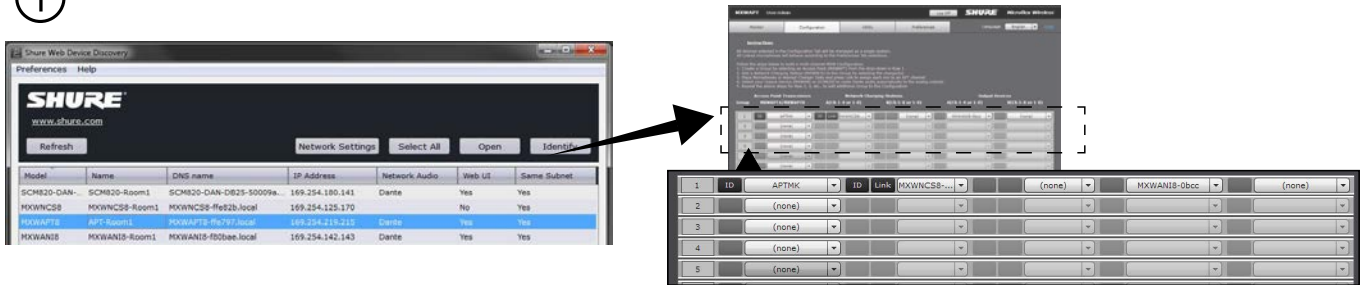

2

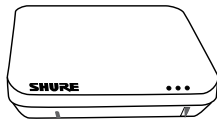

3

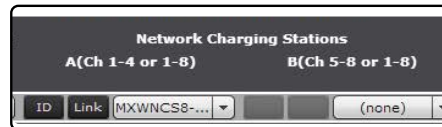
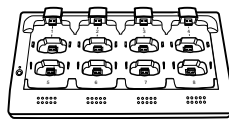

4

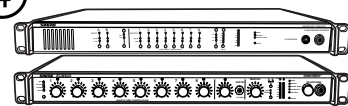

Automatic Group Setup

An MXW Group can be associated without use of the control software when a network is comprised of only one Access Point Transceiver (APT), one Networked Charging Station (NCS) and one Audio Network Interface (ANI). For best results, perform a factory default on the devices to clear any previous Group associations.

1. Connect one APT, one NCS and one ANI to the network. The network must only contain one of each device.
2. Perform a factory reset on the devices (see the Factory Default section).
3. On the front panel of the ANI, press both input level selection buttons at the same time and hold for five seconds. The Channel Select LEDs will illuminate green and the audio meter will flash to indicate that the association is successful.

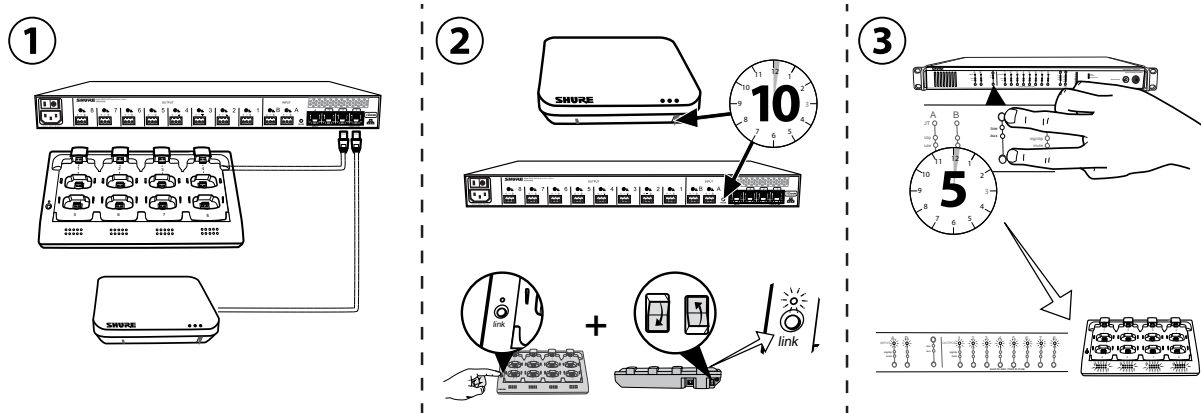

Channel Mapping for Devices in a Group

Audio is routed from the microphones to the analog outputs according to the Group setup in the Configuration tab. The following diagram displays channel mapping for devices in eight- and four-channel Groups.

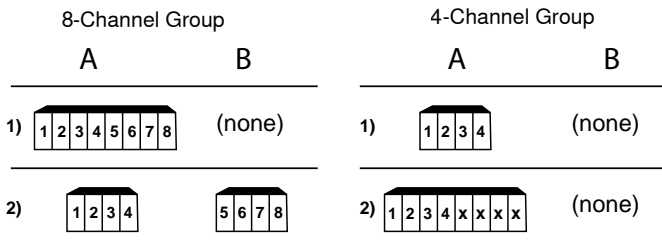

Networked Charging Station

An additional charging station is required when filling a Group with gooseneck microphones

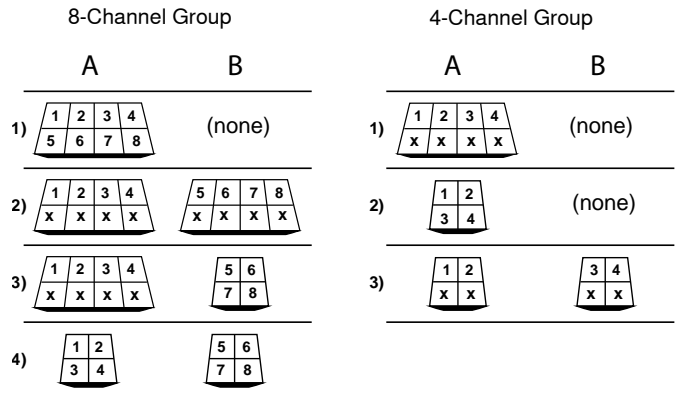

Audio Output Device

Outputs are assigned to an MXW Audio Network Interface or SCM820 Automatic Mixer

Linking Microphones

Use the Networked Charging Station (NCS) to Link microphones to Access Point channels. Slots in the charger are mapped to the APT according to the Group setup from the Configuration tab. Once the Link procedure is complete, audio will route to the corresponding channel in the Group.

Linking will map any microphone placed in the charging station to the APT channels. This replaces any prior microphone Link for that channel. If a slot is empty during the Link procedure, there will be no impact on that channel.

1. Arrange microphones in the charger.

Microphones are Linked to access point channels according to the arrangement in the charger.

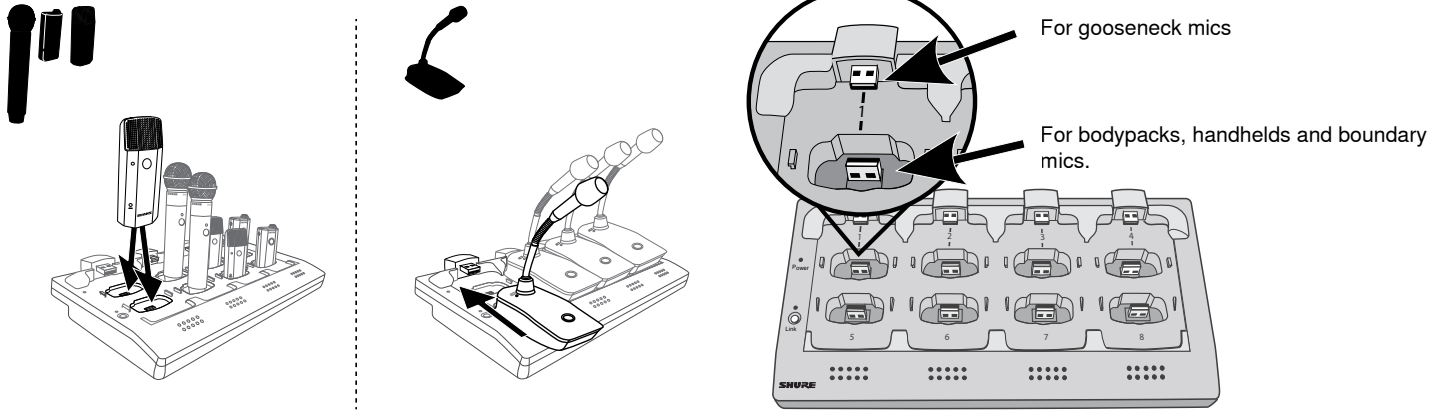

Connecting the Microphone to the Charger Slot

2. Link the microphones to channels.

Use the control software or the charging station to Link the microphones to APT channels. If desired, this feature can be disabled on the charging station so that Linking can only be performed from the control software:

- **Control Software:** From the Configuration page, press the Link button for each charger in the Group.
- **Charging Station:** Press and hold the Link button for 6 seconds. The LEDs flash during the process and turn solid green once the Link is successful.

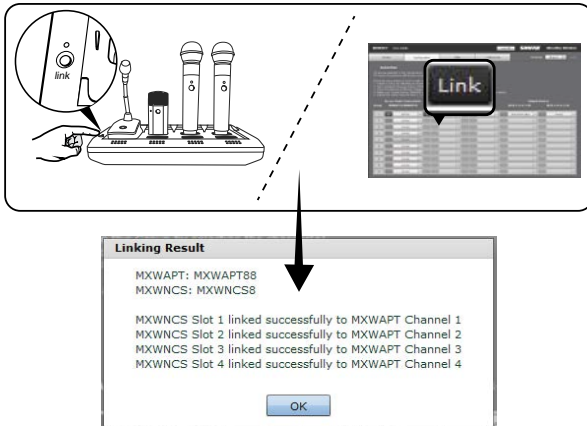

3. Remove Mics and Test the Audio

Test the audio for each microphone and adjust mic gain if necessary from the Monitor tab of the control software. The gain should be set at a level where the audio is registering (green/yellow) on the signal indicator but not clipping (red).

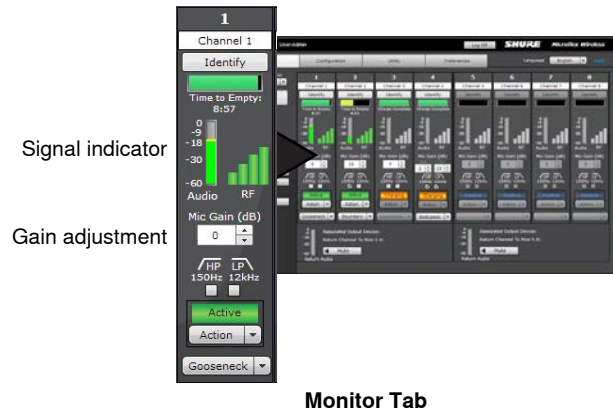

Creating Separate Configurations

For installations that spread across multiple rooms, a different set of preferences and global controls may be required for a given space. Do this by setting up a separate Configuration:

1. Open the Shure Web Device Discovery Application.
2. Select the Access Point that will be used for the new Configuration and open its control software. The APT must be open (not already assigned to a group) in order to start a new configuration.
3. Go to the Configuration tab.
4. Select that Access Point from the drop down list in Row 1. Use the ID button to ensure the correct Access Point is selected.
5. Select the charging station(s) and output device(s) to complete the Group.
6. Repeat 4-5 for up to 10 Groups in the Configuration.
7. Enable the Lock Configuration to improve network performance.
8. Customize the Configuration as desired from the Preferences tab.

Note: Ensure that all APTs are connected to the same network and set to the same subnet, even if they are assigned to a separate Configuration. This ensures the best system performance, highest channel count, and tightest digital audio clocking for the installation.

Device Availability

When setting up a group or managing devices, it is important to understand the difference between open and associated devices.

Open Device

A device that is not associated to a group is considered 'open.' Open devices are available for association by selecting the drop-down window in a Group row. The device will show Open in the Group column of the Utility page.

Associated Device

A device is considered 'associated' once it has been selected in a group row. Each device can only belong to one group at a time (and therefore one Configuration). Once a device has been associated to a group, it is managed on the Configuration tab can be viewed in detail on the Utility tab. The device will show its group number in the Group column of the Utility page.

A device can be unassociated by selecting 'none' in the group row drop-down to clear it from the group. The device is then open and available for association to another group.

Tip: Performing a factory reset will default the device to open.

Associated devices show group number

Available devices show Open

| Group | Device | Type | Name | IP Address Control | IP Address Network Audio | Battery Capacity (%) | Cycle Count | Firmware Version | ID | Device Properties |
|-------|--------|---------|--------------|--------------------|--------------------------|----------------------|-------------|------------------|----|-------------------|
| 1 | APT | MXWAPT8 | APT1 | 169.254.94.198 | 169.254.125.176 | --- | --- | 1.3.2 | ID | Pending |
| 1 | Mic 1 | MXW8 GN | Channel 1 | --- | --- | 100 | 3 | 1.3.2 | ID | Edit |
| 1 | Mic 3 | MXW6 BD | Channel 3 | --- | --- | 100 | 9 | 1.3.2 | ID | Edit |
| 1 | Mic 4 | MXW1 BP | Channel 4 | --- | --- | 98 | 23 | 1.3.2 | ID | Edit |
| 1 | NCS A | MXWNCS8 | MXWNCS8-e82b | 169.254.156.138 | --- | --- | --- | 1.3.2 | ID | Edit |
| Open | Mic | MXW8 GN | [none] | --- | --- | 100 | 2 | 1.3.2 | ID | Edit |
| Open | OUT | MXWANI8 | MXWANI8-0bae | 169.254.142.143 | 169.254.142.143 | --- | --- | 1.3.2 | ID | Edit |
| Open | OUT | SCM820 | SCM820 | 169.254.148.160 | 169.254.161.53 | --- | --- | 1.1.19 | ID | Edit |
| | | | | | | | | | | |
| | | | | | | | | | | |
| | | | | | | | | | | |
| | | | | | | | | | | |
| | | | | | | | | | | |
| | | | | | | | | | | |
| | | | | | | | | | | |
| | | | | | | | | | | |
| | | | | | | | | | | |
| | | | | | | | | | | |
| | | | | | | | | | | |
| | | | | | | | | | | |
| | | | | | | | | | | |
| | | | | | | | | | | |
| | | | | | | | | | | |
| | | | | | | | | | | |

Device Availability

Exchanging or Removing a Component

Exchanging a Transmitter

The same Link procedure is done to exchange a transmitter in a group. Place the new transmitter in the charger slot that corresponds to the desired channel and perform the Link procedure. This will map the new transmitter to that channel, and remove any Link from the old transmitter.

If an NCS channel slot is not connected to a transmitter during the Link procedure, the channel and current transmitter Link will remain unaffected.

Important: Use caution when replacing microphones, as the Link procedure applies for all microphones in the charger. The Link will immediately override any existing microphone's audio and RF connection to the system.

Remove a Device from a Group

To remove a device from a group, open the MXW Control Software and go to the Configuration tab. In the group row, select the device drop-down window that contains the desired device. Select 'none' to clear the device association.

Note: A factory reset will also remove the any association or Link status.

Wireless Management

- **Overview of Channel Coordination** 32
Maximum Channel Count
- **Scanning Available RF Spectrum** 32
Performing a Scan
- **Setting RF Power** 33
- **Using Multiple 4-Channel Access Points** 34
Requirements
Set Up

Overview of Channel Coordination

The MXW system operates using time division multiple access (TDMA) to carry MXW channels (audio and control data) within defined RF spectrum. Channels are automatically assigned to the time-slots by the access point, which manages the spectrum and seamlessly changes slots if interference is detected. The MXW system makes this adjustment automatically and without audio artifacts.

It is important to understand the availability of the spectrum in each environment where an MXW system will be installed and operated. Use the Spectrum Scan in the MXW control software to determine the maximum number of channels that can be safely added to the system.

Maximum Channel Count

The following table displays the maximum MXW channel count in each region.

| Band | Region | Maximum Channel Count |
|------|---------------------------|-----------------------|
| Z10 | USA, Canada, Mexico | 40 |
| Z11 | Europe, Asia, Middle-East | 80 |
| Z12 | Japan | 40 |
| Z14 | Brazil | 40 |
| Z15 | Taiwan | 64 |

Scanning Available RF Spectrum

The MXW Wireless components operate in unlicensed spectrum that is shared with other wireless devices operating in the same area, such as cordless phones, walkie-talkies and intercoms. The MXW control software features a scanning tool that surveys the RF spectrum for these devices. It calculates the percentage of Radio Frequency Interference (RFI) in the area and provides recommended channel count ranges. It provides the current and peak percentages of RFI activity for up to 24 hours.

During a scan, any microphones Linked to that Access Point are turned off in order to survey the area for interference from other devices. The scan calculates the current spectrum and the minimum spectrum available, which provides the greatest level of safety in determining channel count availability in a space. The Minimum Spectrum Available data will persist until a new scan is performed or the data is cleared.

Radio Frequency Interference (RFI)

The scanner analyzes the spectrum and divides the data into three categories:

No/Low (Green): Clean RF available for MXW system.

Moderate (Yellow): Some moderate interference is detected, still usable by the MXW system.

High (Red): Busy RF occupied by other devices.

Estimated Mic Channel Count

The scanner provides two estimate levels for MXW microphones:

Conservative (More Robust)

Reference this channel estimate for maximum channel stability. It includes extra usable spectrum for optimal interference avoidance, allowing multiple microphones to find available frequencies simultaneously.

Aggressive (More Channels).

Reference this channel estimate if a higher channel count is necessary for the installation. It reserves only the minimum required extra spectrum for interference avoidance. Be sure to occasionally monitor the spectrum and make channel adjustments if the RFI increases.

Performing a Scan

Follow these steps to perform RF scan.

Tip: Perform the scan during typical hours of operation to best capture the typical interference in an environment.

1. Ensure all typically used devices are turned on, including any MXW equipment already in use.
2. Place the new MXW Access Point near the location it will be mounted.
3. Ensure the APT is on the same network and set to the same subnet as the other MXW equipment.
4. Open the Monitor tab of the MXW control software.
5. Make sure the new Access Point is selected from the drop down on the top left corner of the Monitor tab.
6. Press the Spectrum Scanner button. The Spectrum Scan window opens.
7. Press the Start Scan button at the top of the window. If any microphones are Linked to that Access Point, they will be turned off.
8. Allow the scan to run for up to 24 hours. Press End Scan to end the scan mode.

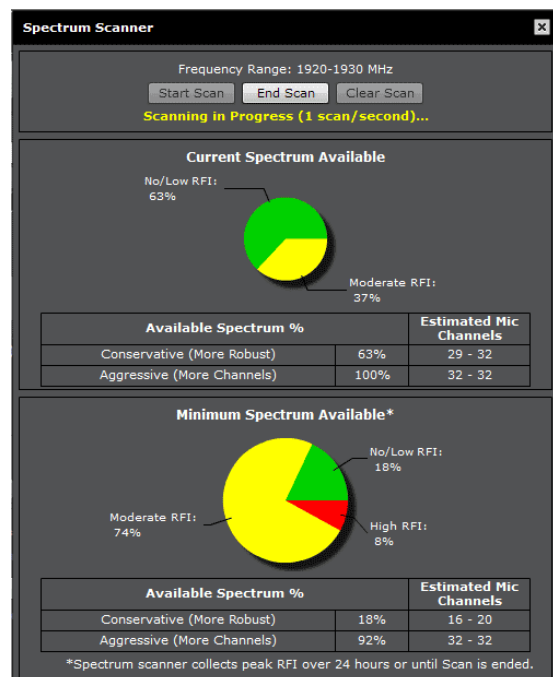

Setting RF Power

The RF radius of a configuration can be limited to allow another MXW system to re-use the frequency time-slots. It is best practice to use the lowest setting that supports the installation. Perform a walk-around test with the transmitters to ensure that the coverage setting is sufficient.

The RF Power is set from the Preferences tab of the control software. The setting applies to each access point in the Configuration. Reference the following table for setting the RF Power.

RF Power Levels

| Setting | Transmitter Power (mW) | Coverage Distance from APT | Typical Application |
|------------------|------------------------|----------------------------|---|
| Max | 80 | 150 ft | Ballroom and auditorium spaces |
| High | 16 | 100 ft | Large meeting spaces and lecture halls |
| Medium (default) | 3 | 50 ft | Conference, training and multipurpose rooms |
| Low | 1 | 25 ft | Small video-conference rooms and boardrooms |

Using Multiple 4-Channel Access Points

The MXW access point uses two sets of antennas to cover the operating spectrum. Each antenna set covers half of the timeslots used for MXW channels. Eight-channel units use both antenna sets simultaneously; four-channel units use one set at a time, operating on half of the available timeslots. The full spectrum can be covered by two four-channel access points when they are configured to alternating antenna sets.

When an installation uses multiple four-channel access points (APT4), configure the access point settings to maximize channel count. This is particularly important for APT4s that are mounted in the same room or adjacent rooms.

Requirements

The MXW system must be operating on a minimum firmware version of 2.0.0.

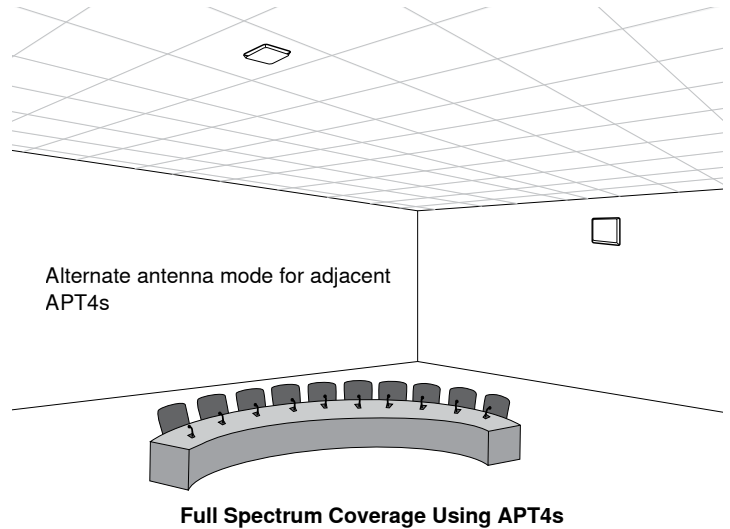

Set Up

1. Open the MXW control software using the Shure Web Device Discovery application.
2. Go to the Utility page.
3. Open the Device Properties window for the four-channel access point (MXWAPT4).

| Group | Device | Type | Name | IP Address Control | IP Address Network Audio | Battery Capacity (%) | Cycle Count | Firmware Version | ID | Device Properties |
|-------|--------|---------|-----------------------|--------------------|--------------------------|----------------------|-------------|------------------|----|-------------------|
| 1 | APT | MXWAPT4 | MXWAPT4-e6e2 | 169.254.155.195 | 169.254.125.232 | --- | --- | 1.3.0 | ID | Edit |
| 1 | Mic 1 | MXW1 BP | Channel 1 | --- | --- | 97 | 4 | 1.3.0 | ID | Edit |
| 1 | Mic 2 | MXW6 GN | Channel 2 | --- | --- | 100 | 13 | 1.3.0 | ID | Edit |
| 1 | Mic 3 | MXW6 BD | Channel 3 | --- | --- | 95 | 18 | 1.3.0 | ID | Edit |
| 1 | Mic 4 | MXW2 HI | Channel 4 | --- | --- | 96 | 2 | 1.3.0 | ID | Edit |
| 1 | MCS A | MXWNC54 | MXWNC54-3ef5 | 169.254.15.187 | --- | --- | --- | 1.3.0 | ID | Edit |
| 1 | OUT A | MXWAN6 | MXWAN6-0297 | 169.254.142.120 | 169.254.142.120 | --- | --- | 1.3.0 | ID | Edit |
| Open | OUT | SCH20 | Don't-Update-Me-SCH20 | 169.254.53.6 | 169.254.140.179 | --- | --- | 1.1.18 | ID | Edit |

4. Note that the APT is set to Mode A (**Device View > RF Mode Settings > RF Coordination Mode**). Close out of the window.

Device Type: MXWAPT4

Device Name: MXWAPT4-e6e2 Factory Reset

Serial Number: 4121660102

Network Settings

| Interface | Control | Network Audio |
|-------------|---------------------|---------------------|
| IP Mode | Manual (Static) | Auto (DHCP) |
| IP Address | 192 . 168 . 1 . 150 | 192 . 168 . 1 . 59 |
| Subnet Mask | 255 . 255 . 255 . 0 | 255 . 255 . 255 . 0 |
| Gateway | 192 . 168 . 1 . 1 | 0 . 0 . 0 . 0 |
| MAC Address | 00:0E:DD:FF:E6:E2 | 00:0E:DD:FF:EB:07 |

RF Mode Settings

RF Coordination Mode: Mode A

Recommendation: Alternate the RF Coordination Mode in adjacent rooms (Ex: Room A, Room B, Room A) to optimize spectrum use.

Add Updates Cancel Updates

Note that changes will only take place after pressing the Pending Changes: "Apply All" button on the Utility Page.

5. Open the Device Properties for the adjacent APT4.
6. Set the unit to Mode B (**Device View > RF Mode Settings > RF Coordination Mode**).
7. Select Add Updates to save the setting and close the window.
8. Make sure any additional APT4s are set to alternating RF Coordination modes.
9. Select Apply All button on the Utility page to update all device settings.

Networking

| | |
|--|-----------|
| ■ Networking Best Practices | 36 |
| ■ Description of the Network Interfaces | 36 |
| ■ Configuring IP Settings | 37 |
| ■ Advanced Setup | 38 |
| Managing Large Systems on a Single Network | |
| Manually Assigning Static IP Address | |
| Isolating Audio and Control Networks | |
| Operating the Control Software over Wi-Fi | |
| Dedicate a Device for Master Clock | |
| Setting Latency | |

Networking Best Practices

Use the following best practices when setting up a network to ensure reliable communication:

- Always use a "star" network topology by connecting each component directly to the switch or router.
- Connect networked MXW gear to the same network and set to the same subnet. This ensures best system performance and maximum microphone count.
- Use only 1 DHCP server per network. Disable DHCP addressing on additional servers.
- Power on the switch and DHCP server prior to MXW equipment.
- To expand the network, use multiple Ethernet switches in a star topology.
- Connect each device directly to the port of an Ethernet switch. Avoid "daisy-chaining" Ethernet port connections between devices for larger networks.
- Do not loop network connections.
- All devices must be at the same firmware revision level.

Description of the Network Interfaces

MXW components are designed as a plug-and-play system, discovering each other automatically when connected over standard Ethernet equipment. Components are then grouped together to transport two types of data: Shure Control and Network Audio. Both interfaces use the same network jack and cable for transport.

The following describes the two interfaces and their functions in the MXW system:

Control

The Shure Control carries data for the control software operation, firmware updates and 3rd party control systems (AMX, Crestron). This data is transported to all MXW components connected to the network.

Network Audio

This network carries both the Dante digital audio and the control data for Dante Controller. This data is transmitted between the APT, the output device and the computer. The network audio requires a wired, gigabit Ethernet connection to operate.

Network Interfaces for Each MXW Component

| Component | Interface Description |
|----------------------------------|--|
| Access Point Transceiver (APT) | Shure Control and Network Audio are configured to separate IP settings |
| Audio Network Interface (ANI) | Shure Control and Network Audio are combined to share the same IP settings |
| Networked Charging Station (NCS) | Shure Control IP settings only. Network Audio is not transported by NCS. |

Configuring IP Settings

Go to the Utility tab of the control software to manage the IP configurations of each network interface. By default, they are set to Automatic (DHCP) mode. DHCP mode enables the devices to accept IP settings from a DHCP server, or automatically fall back to Link-Local settings when no DHCP is available. To manually set the IP address of an interface, select Manual (Static).

The MXW control software coordinates IP updates across the entire system of devices. To configure the IP properties, follow these steps:

1. Open the MXW control software from the Shure Web Device Discovery app.
2. Go to the Utility tab.
3. Adjust IP settings for each device by selecting the Device Properties..

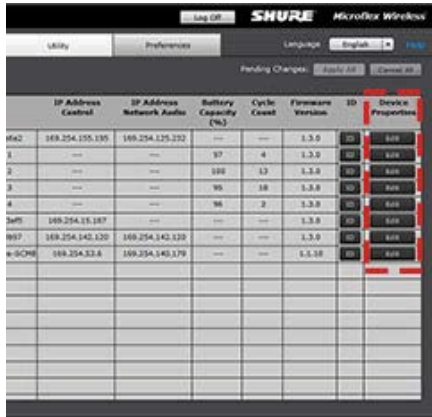

5. Repeat for any additional components.
6. To send updates to the devices, select Apply All to the Pending Changes field of the Utility page.

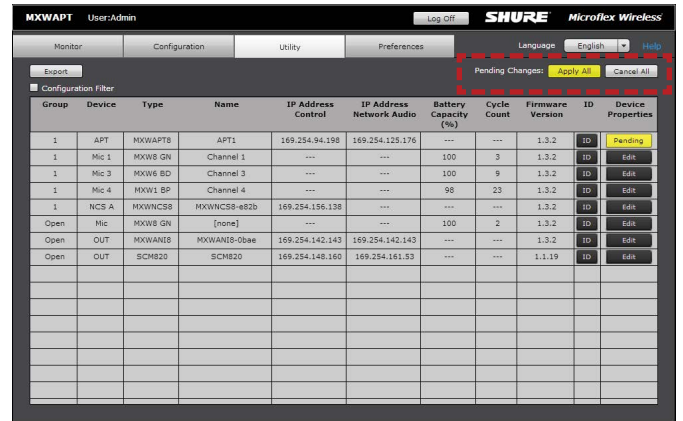

4. After adjustments have been made, select Add Updates. This saves the settings to the changes queue.



7. The computer may temporarily lose connection to the control software during the updates process. When the device has been reconfigured, reopen the software using the Shure Device Discovery application.

Go to **Utility > Device Properties** to manage the interfaces of each MXW device on the network.

IP Settings Description

Interface

View and adjust IP settings for the device's network interface(s). Network settings are different for each device.

- **Control:** Shure control (software interface operation, firmware updates, Shure Device Discovery application).
- **Network Audio:** Dante network audio (digital audio networking and Dante software).

IP Mode

Sets IP mode of the selected network interface:

- **Auto (DHCP):** For automatic assignment of IP addresses.
- **Manual (Static):** For Static IP addresses.

IP Settings

View and edit the IP Address, Subnet Mask, and Gateway for each network interface.

MAC Address

The network interface's unique identification.

Add Updates

Select Add Updates to save the device changes to the control software. All device properties are updated simultaneously from the Utility tab. Once saved, the device will show Pending under the Properties column.

Cancel Updates

Remove any changes made to the device properties.

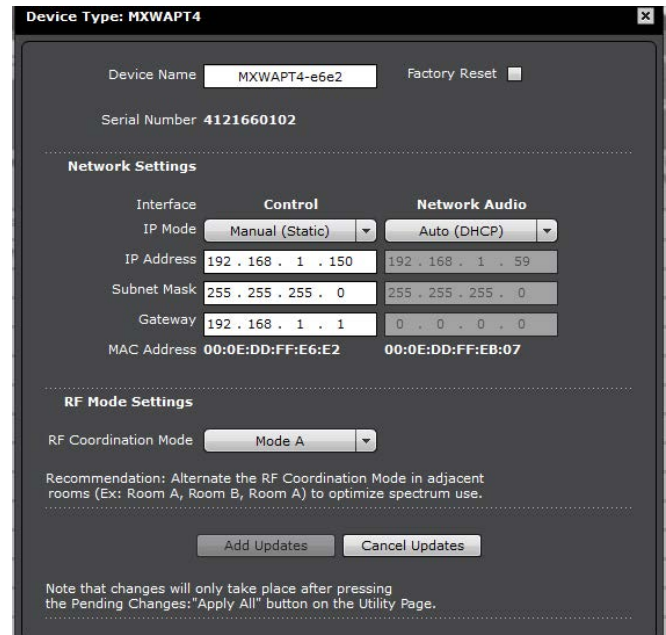

Device Properties

Advanced Setup

For more information on configuring advanced MXW networks, reference the Microflex Wireless Networking whitepaper located at www.shure.com.

Managing Large Systems on a Single Network

To manage large systems on a single network, lock the configuration after setting it up. This improves network performance and stability, allowing a greater number of MXW systems to operate on the same network. This is especially important if there are more than 15 total MXW APTs on a subnet.

Tip: Use an isolated network to set up or modify a configuration for best system performance.

1. Connect the MXW equipment and a computer to an isolated network.
2. Open the MXW browser interface to the Configuration tab.
3. Create the configuration by associating each APT to the audio output device(s) and network charging station(s).
4. Select the Lock Configuration box.
5. Connect the components to the intended network.
6. Repeat for additional configurations.

Manually Assigning Static IP Address

To manually assign IP addresses to the MXW system, follow these steps:

1. Open the Utility tab.
2. Select Edit to open the device properties window.
3. Select the Manual (Static) IP Mode.
4. Enter the IP settings
5. Select the Add Updates button to queue the saved settings.
6. Repeat for all additional components
7. Finalize all updates by pressing the Apply All button from the Utility tab. All devices with pending changes will update.

Note: The control software may close if settings have been updated for the APT.

8. Change the computer's IP address to match the subnet of the MXW equipment.
9. Reopen the MXW control interface using the Shure Device Discovery application.

Isolating Audio and Control Networks

When connecting to corporate networks, the MXW system can be configured to isolate audio and control networks. This protects audio from distributing to the entire network and significantly decreases network traffic.

Using the Audio Network Interface

The MXW Audio Network Interface (ANI) can be configured to dedicate one of its network ports as a control-only connection. Uplink mode blocks multicast traffic from Port 4 of the ANI, restricting network audio and Shure Discovery data.

Because the device will not show up in the Shure Device Discovery application, the IP address of the control software must be recorded to access the server.

1. Record the IP address of the control software.
2. Connect Port 4 of the ANI to the network.
3. Use the Shure Web Device Discovery application to open the control software of the ANI.
4. Go to the Preferences tab.
5. Under the Network panel, change Port 4 Mode to Uplink.

Operating the Control Software over Wi-Fi

When operating the MXW control software over Wi-Fi, it's important to set up the wireless router properly for best performance. The MXW System employs several standard-based protocols that rely on multicast. Wi-Fi treats broadcast and multicast packets differently than general packets for backward compatibility reasons. In some cases, the Wi-Fi router will limit the multicast packet transmission rate to a value that is too slow for GUI to properly operate.

Wi-Fi routers typically support 802.11b, 802.11a/g, and/or 802.11n standards. By default, many Wi-Fi routers are configured to allow older 802.11b devices to operate over the network. In this configuration, these routers will automatically limit the multicast data rates (or sometimes referred to as 'basic rate', or 'management rate') to 1-2Mbps.

Note: A Wi-Fi connection can only be used for the control software. Network audio cannot be transmitted over Wi-Fi.

Tip: For larger wireless microphone configurations, it's recommended to increase the multicast transmission rate to provide adequate bandwidth to the MXW control software.

Important: For best performance, use a Wi-Fi router that does not limit the multicast rate to 1-2 Mbps.

Shure recommends the following Wi-Fi router brands:

- Cisco
- Linksys
- Apple

Dedicate a Device for Master Clock

Dante uses the IEEE 1588 Precision Time Protocol (PTP) to automatically select one device as the master clock for all Dante devices on the network. PTP ensures that all devices are similarly clocked, which is critical for both audio delivery over the network and time-synced RF transmission over the wireless link. The master clock in an MXW System is the first MXW access point that connects to the network. If several connect simultaneously, the access point with the lowest MAC address will be selected. Additional MXW components on the same network synchronize (slave) to this access point clock master.

When a master device shuts down or goes offline, the system will automatically begin selecting another master. During this selection time (up to 30 seconds), the entire system will **NOT** pass audio.

If the network setup or building management requires that devices are periodically shut down, you can manually select an access point as the Preferred Master device from Dante Controller software. This allows the installer to set up the system to ensure that the master access point never shuts down during events.

Setting Latency

Latency is the amount of time for a signal to travel across the system to the outputs of a device. To account for variances in latency time between devices and channels, Dante has a predetermined selection of latency settings. When the same setting is selected, it ensures that all Dante devices on the network are in sync.

The latency setting for Dante devices should be set according to the number of switches in the network. The MXW Audio Network Interface and Access Point both include an internal switch chip, which counts as a switch. For example, one network interface connected to an access point equals two switches.

Use Audinate's Dante Controller software to change the latency setting.

Latency Recommendations

| Latency Setting | Maximum Number of Switches |
|------------------|----------------------------|
| 0.25 ms | 3 |
| 0.5 ms (default) | 5 |
| 1 ms | 10 |
| 2 ms | 10+ |

Software

| | |
|---|-----------|
| ■ Shure Web Device Discovery Application | 41 |
| ■ MXW System Control Software | 41 |
| Log On Page | |
| Control Bar | |
| Monitor Tab | |
| Configuration Tab | |
| Utility Tab | |
| Preferences Tab | |
| ■ Control Software for the MXW Audio Network Interface | 48 |
| Log On Page | |
| Control Bar | |
| Inputs/Outputs Tab | |
| Preferences Tab | |
| ■ Dante™ Software by Audinate | 51 |
| Dante Controller | |
| Dante Virtual Soundcard | |
| ■ Firmware Updates | 52 |
| Firmware Release Requirements | |

Shure Web Device Discovery Application

The Shure Web Device Discovery application is used to access the graphical user interface (GUI) of a Shure device. The GUI opens in a web browser to provide comprehensive device management. Any computer networked to the device can access the GUI with this application.

To use the application,

- Double-click on a device or press the Open button to open a GUI.
- Right-click on a device to copy its IP address or DNS name.
- Select Network Settings to monitor the computer's network interface details.

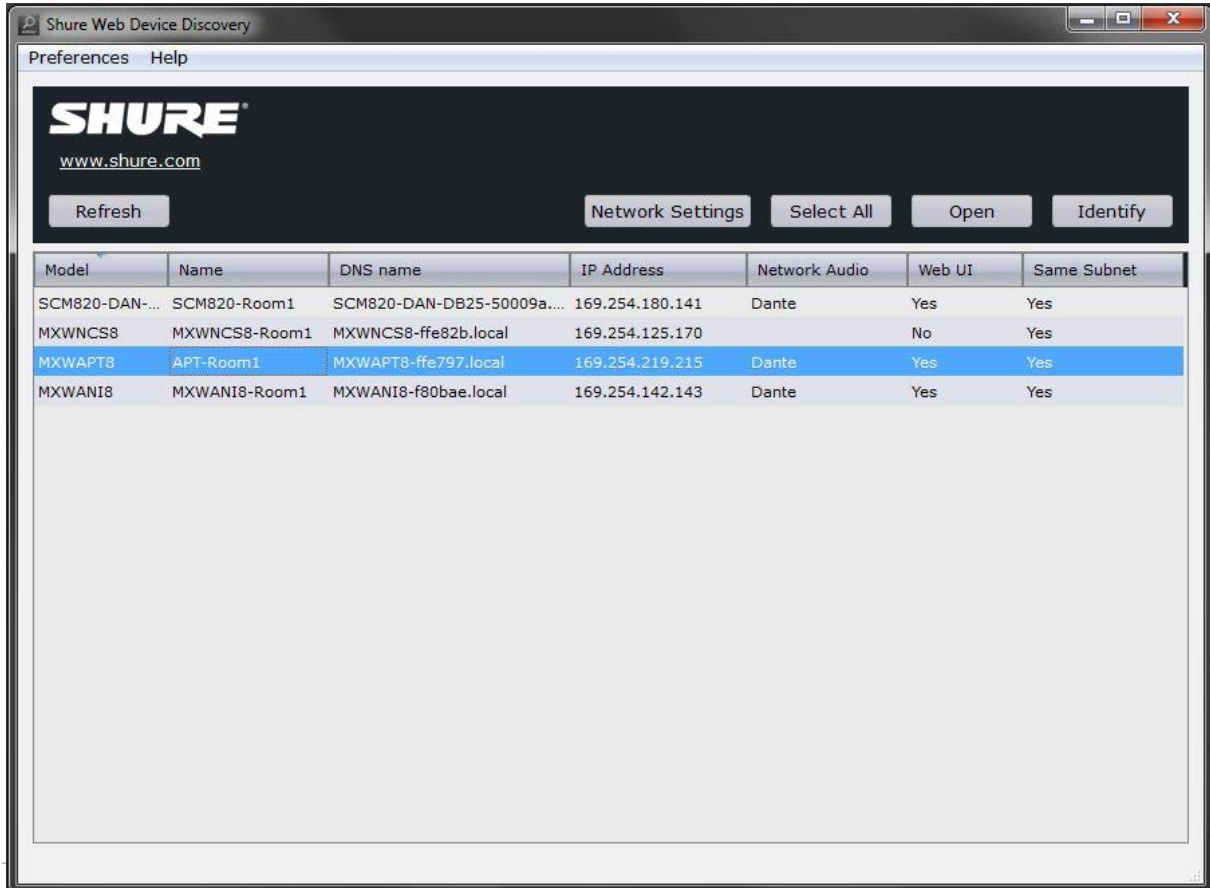

MXW System Control Software

The MXW control software allows comprehensive system control and monitoring from a computer. It is hosted from an embedded server in the MXW Access Point, and is accessible when properly networked to a computer. All hardware functions can be adjusted using this software interface.



Log On Page

① User

There are three security levels to the Control Software: Admin, Tech and Guest. By default, only Admin is enabled. Log on and go to the Preferences tab to manage the User log on.

Admin (default): Full editing rights. The Admin can enable or disable a Tech-level logon.

Tech: Partial editing rights, limited to microphone management on the Monitor tab.

Guest: Monitoring only.

② Password

Enter the password to log on as an Admin or Tech. The default password is 'admin' for the Admin user. To change the password, log on as an Admin and go to the Preferences tab.

③ Keep Me Logged On Button

When selected, this allows the user to bypass the Log On page when reopening the control software.

④ Language Selection

Selects the language for the GUI. This setting will be saved to the computer.

⑤ Log On Button

Press the button to log onto the control software.

Note: Default password is 'admin'



Control Bar

① Tabs

- Monitor: Adjust microphone status and view RF spectrum availability.
- Configuration: Form groups of components
- Utility: View details and manage IP settings of each MXW device on the network
- Preferences: Assign microphone and system behavior

② Security Level

Displays the access level of the user: Administrator, Technician, or Guest.

③ Log Off

Logs the user out of the software.

④ Shure Link

Links to the Shure website at www.shure.com.

⑤ Language Selection

Selects the language for the control software interface. This setting will be saved to the computer.

Monitor Tab



① Access Point Selection

Determines which Access Point is displayed on the tab.

② Spectrum Meter

Opens the Spectrum Scanner window. See Scanning Available RF Spectrum section for more details.

③ Global Mic Control

Controls the status of all transmitters in the configuration.

④ Channel Name

Channel names are customizable and apply to any Linked transmitter. The name persists even if a transmitter is re-Linked.

⑤ Identify Button

When clicked, this commands the transmitter to beep and its LED to flash.

⑥ Battery Status

In the charger: Displays the remaining time until the transmitter battery is fully charged.

Out of the charger: Displays the remaining battery runtime of the transmitter.

⑦ RF Signal Strength

Indicates the signal strength of the transmitter. When the bars are grey, the transmitter is out of range.

⑧ Audio Input Meter

Indicates the average input signal level.

| Color | Audio Signal Level (dBFS) | Description |
|--------|---------------------------|----------------|
| Red | 0 to -9 | Overload |
| Yellow | -9 to -18 | Normal peaks |
| Green | -18 to -60 | Signal Present |

⑨ Mic Gain

Adjusts transmitter gain from -25 dB to +15 dB gain in 1 dB steps.

⑩ High-Pass Filter

Engages a 12 dB-per-octave filter below 150 Hz for attenuating undesired low frequencies, sometimes caused by table vibrations or air-conditioning rumble.

⑪ Low-Pass Filter

Engages a 6 dB-per-octave filter above 12 kHz for attenuating undesired high frequencies, sometimes caused by sibilant vocals or paper rustling.

⑫ Transmitter State

Displays the operating status of the MXW transmitter:

- **Active:** On and passing audio to the network.
- **Mute:** On but the audio is muted.
- **Standby:** On but in a 'sleep' state with audio muted. Standby conserves battery charge and enables a change to the transmitter's status from the control software.
- **Inactive:** Off or out-of-range. A transmitter in this state cannot be remotely controlled by the software.
- **Charging:** Battery is charging.
- **External:** On and passing audio to an external controller that controls the mute/active behavior.

⑬ Action

Change the transmitter state by selecting from the drop-down window:

- Active
- Mute
- Standby

⑭ Transmitter Type

Displays the transmitter type and provides a Power Off selection from the drop-down window.

⑮ Bodypack Mic Options

There are two input sources available on the MXW1 bodypack: the internal, omnidirectional microphone or the external, TQG input for lavalier or headset microphones. Select the input source preference:

- Auto: The internal mic is used until the MXW1 detects a connection at the TQG input. The transmitter automatically selects the external source whenever available.
- Internal: Audio source is always from the internal microphone.
- External: Audio source is always from a connected microphone. (Internal mic is off.)

⑯ Return Channels

Monitor the signal level and mute/unmute the audio of the return channel.

Configuration Tab

MXWAPT User:Admin Log Off **SHURE** Microflex Wireless

Monitor Configuration Utility Preferences Language English Help

Instructions

All devices selected in the Configuration Tab will be managed as a single system.
All Linked microphones will behave according to the Preferences Tab selections.

Follow the steps below to build a multi-channel MXW Configuration.

1. Create a Group by selecting an Access Point (MXWAPT) from the drop-down in Row 1
2. Add a Network Charging Station (MXWNCS) to this Group by selecting the charger(s)
3. Place Microphones in desired Charger Slots and press Link to assign each mic to an APT channel
4. Select your Output Device (MXWANI or SCM820) to route Dante audio automatically to the analog outputs
5. Repeat the above steps for Row 2, 3, etc., to add additional Group to this Configuration
6. Lock the configuration

Configuration Lock

4 Configuration Lock

| Group | Access Point Transceivers | | Network Charging Stations | | Output Devices | |
|-------|---------------------------|---------|---------------------------|------------------|------------------|------------------|
| | MXWAPT4/MXWAPT8 | | A(Ch 1-4 or 1-8) | B(Ch 5-8 or 1-8) | A(Ch 1-4 or 1-8) | B(Ch 5-8 or 1-8) |
| 1 | ID APT-Room1 | ID Link | MXWNCS8-... | (none) | ID MXWANI8-Room1 | (none) |
| 2 | (none) | | | | | |
| 3 | (none) | | | | | |
| 4 | (none) | | | | | |
| 5 | (none) | | | | | |
| 6 | (none) | | | | | |
| 7 | (none) | | | | | |
| 8 | (none) | | | | | |
| 9 | (none) | | | | | |
| 10 | (none) | | | | | |

① Group Row

Each row represents a Group in the Configuration. Select an APT and associate chargers and audio output devices to form each Group.

② ID Button

Commands the selected device's LEDs to flash for easy identification.

③ Link Button

Links all microphones in the charger to channels in the associated Group.

④ Configuration Lock

Increases the number of MXW components that can operate on the same network. It is best practice to lock the configuration after setup to greatly reduce network traffic from MXW equipment. When systems exceed 15 APTs on the same network, configuration locking is required for stable performance.

Note: When selected, Groups are not editable on the Configuration page and the Utility page only displays information for devices belonging to this Configuration.

Utility Tab

MXWAPT User:Admin Log Off SHURE Microflex Wireless

Monitor Configuration **Utility** Preferences Language English Help

1 Export Pending Changes: Apply All 14 Cancel All

2 Configuration Filter

| Group | Device | Type | Name | IP Address Control | IP Address Network Audio | Battery Capacity (%) | Cycle Count | Firmware Version | ID | Device Properties |
|-------|--------|---------|--------------|--------------------|--------------------------|----------------------|-------------|------------------|----|-------------------|
| 3 | 4 | 5 | 6 | 7 | 8 | 9 | 10 | 11 | 12 | 13 |
| 1 | APT | MXWAPT8 | APT1 | 169.254.94.198 | 169.254.125.176 | --- | --- | 1.3.2 | ID | Pending |
| 1 | Mic 1 | MXW8 GN | Channel 1 | --- | --- | 100 | 3 | 1.3.2 | ID | Edit |
| 1 | Mic 3 | MXW6 BD | Channel 3 | --- | --- | 100 | 9 | 1.3.2 | ID | Edit |
| 1 | Mic 4 | MXW1 BP | Channel 4 | --- | --- | 98 | 23 | 1.3.2 | ID | Edit |
| 1 | NCS A | MXWNCS8 | MXWNCS8-e82b | 169.254.156.138 | --- | --- | --- | 1.3.2 | ID | Edit |
| Open | Mic | MXW8 GN | [none] | --- | --- | 100 | 2 | 1.3.2 | ID | Edit |
| Open | OUT | MXWAN18 | MXWAN18-0bae | 169.254.142.143 | 169.254.142.143 | --- | --- | 1.3.2 | ID | Edit |
| Open | OUT | SCM820 | SCM820 | 169.254.148.160 | 169.254.161.53 | --- | --- | 1.1.19 | ID | Edit |
| | | | | | | | | | | |
| | | | | | | | | | | |
| | | | | | | | | | | |
| | | | | | | | | | | |
| | | | | | | | | | | |
| | | | | | | | | | | |
| | | | | | | | | | | |
| | | | | | | | | | | |
| | | | | | | | | | | |
| | | | | | | | | | | |
| | | | | | | | | | | |
| | | | | | | | | | | |
| | | | | | | | | | | |
| | | | | | | | | | | |

① Export Button

Exports MXW device data to a text file (.csv).

② Configuration Filter

When checked, the table displays data for only the devices that belong to the Configuration or are open for association. Un-check the filter to view all MXW devices on the subnet.

Note: The filter is checked when the configuration is locked from the Configuration tab.

③ Group

Indicates the device's status in a Group:

- **1 - 10:** Device is associated to that Group in the Configuration
- **Open:** Device is not associated to any Group
- **None:** Microphone is Linked to an Access Point that has been removed from a Group (deselected from the Group row in the Configuration tab)
- **Standalone:** Audio Network Interface is set to Standalone mode, which restricts association to a Group
- **Unknown:** Microphone is Linked to an APT that is powered off or connected to a different network
- **Other:** Device is associated to a Group in a different Configuration

④ Device

The device type or microphone channel.

⑤ Type

The device model number.

⑥ Name

Displays device name as defined in the Configuration tab or channel name as defined in the Monitor tab.

⑦ IP Address Control

Displays the IP Address of the control network interface (Shure control data).

⑧ IP Address Network Audio

Displays the IP Address of the Network Audio network interface (Dante digital audio data).

⑨ Battery Capacity

The microphone battery's percentage of charge capacity as compared to a new battery.

⑩ Cycle Count

Number of charge cycles logged by the battery.

⑪ Firmware Version

Displays the device's firmware version.

⑫ ID Button

Sends a signal to the device to flash its LEDs for easy identification.

⑬ Device Properties

Opens a window for editing the properties of an individual device. The button displays yellow when the properties have been edited for that device. The changes can be applied or cancelled from the Pending Changes Buttons on the Utility tab.

⑭ Pending Changes Buttons

These buttons confirm or cancel any changes made to the device properties:

- **Apply All:** Confirms and executes all updates to device properties. At this time, the computer may lose connection to the control software.
- **Cancel All:** Clears all pending changes to the device properties.

Device Type: MXWAPT8

① Device Name Factory Reset ③

② Serial Number 4121660014

Network Settings

| ④ Interface | Control | Network Audio |
|---------------|----------------------|-----------------------|
| ⑤ IP Mode | Auto (DHCP) | Auto (DHCP) |
| IP Address | 169 . 254 . 94 . 198 | 169 . 254 . 125 . 176 |
| ⑥ Subnet Mask | 255 . 255 . 0 . 0 | 255 . 255 . 0 . 0 |
| Gateway | 0 . 0 . 0 . 0 | 0 . 0 . 0 . 0 |
| ⑦ MAC Address | 00:0E:DD:FF:E7:97 | 00:0E:DD:FF:EA:CF |

⑧ Add Updates Cancel Updates ⑨

Note that changes will only take place after pressing the Pending Changes: "Apply All" button on the Utility Page.

Device Properties Window

Edit the network settings for each device from this window. Device properties are edited individually, but are updated at the same time from the Utility page. This ensures proper deployment of network settings.

① Device Name

Device names can be customized with up to 31 characters.

② Serial Number

The unique identifier used to register the device at the Shure website, guarantee the warranty, and troubleshooting with customer support.

③ Factory Reset

The unique identifier used to register the device at the Shure website, guarantee the warranty, and troubleshooting with customer support.

④ Interface Selection

View and adjust IP settings for the device's network interface(s). Network settings are different for each device. See the Networking section for configuring each MXW device.

- **Control:** Shure control (software interface operation, firmware updates, Shure Device Discovery application).
- **Network Audio:** Dante network audio (digital audio networking and Dante software).

⑤ IP Mode

Sets IP mode of the selected network interface:

- **Auto (DHCP):** For automatic assignment of IP addresses.
- **Manual (Static):** For Static IP addresses.

⑥ IP Settings

View and edit the IP Address, Subnet Mask, and Gateway for each network interface.

⑦ MAC Address

The network interface's unique identification.

⑧ Add Updates

Select Add Updates to save the device changes to the control software. All device properties are updated simultaneously from the Utility tab. Once saved, the device will show Pending under the Properties column.

⑨ Cancel Updates

Remove any changes made to the device properties.

Preferences Tab

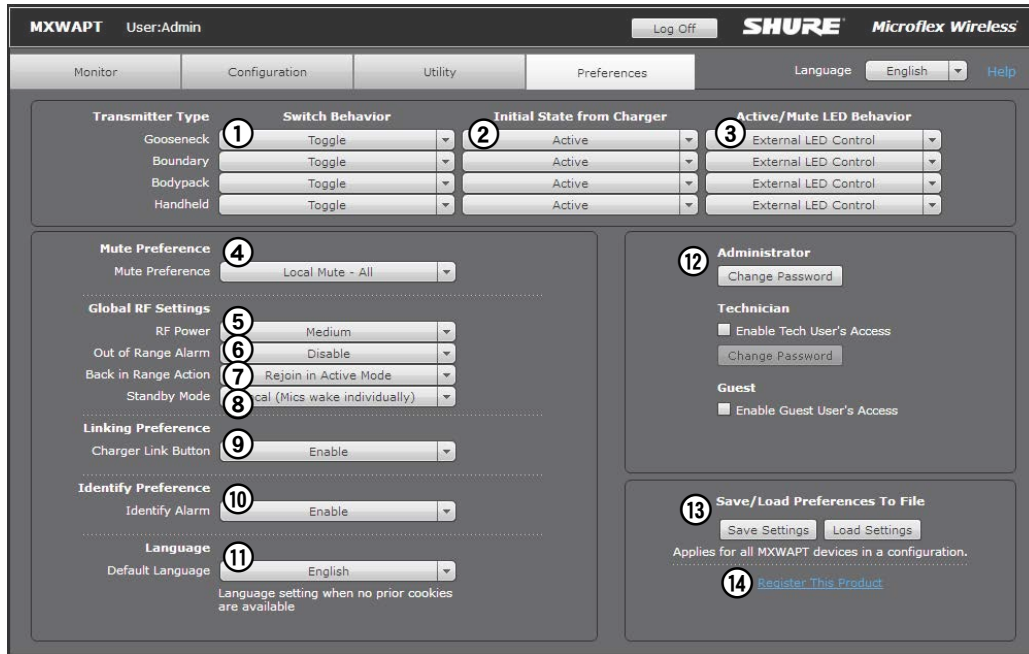

All preferences apply to each device in the Configuration.

① Switch Behavior

Customize the switch on each transmitter type.

- **Toggle (default):** Press and release the button to change the status to Active or Mute.
- **Push-to-talk:** Hold button to pass audio.
- **Push-to-mute:** Hold button to mute the audio.
- **Disabled:** The button does not affect the audio.

② Initial State from Charger

Assigns the state for the transmitter after it has been removed from the charger:

- **Active:** On and passing audio to the network.
- **Mute:** On but the audio is muted.
- **Standby:** On but in a 'sleep' state with audio muted. Standby conserves battery charge and enables a change to the transmitter's status from the control software.
- **Off:** Power is off. A transmitter in this state cannot be remotely controlled by the software.

③ LED Behavior

Set the behavior of the mute/active LED for each transmitter type. Standby mode is always represented with a pulsing red LED.

| Active | Mute |
|----------------------|--------------|
| Solid Green* | Solid Red |
| Solid Red | Flashing Red |
| Solid Red | Off |
| External LED Control | |

*Not available for MX400R series gooseneck microphones

④ Mute Preference

- **Local Mute - Individual (default):** Each transmitter is muted individually.
- **Local Mute - All:** All transmitters mute when any transmitter is muted.
- **External Mute:** Transmitter audio is on, and muted from a 3rd-party controller.

⑤ RF Power

Determines the RF coverage of an access point.

- **Low:** 25 ft (1mW)
- **Medium:** 50 ft (3 mW)
- **Medium High:** 100 ft (16 mW)
- **Max:** 150 ft (80 mW)

⑥ Out of Range Alarm

When enabled, a transmitter will audibly beep when it is taken out of the RF coverage area. (Disabled by default.)

⑦ Back in Range Action

Transmitters can be set to automatically activate (default) or mute when they re-enter the RF coverage area.

⑧ Standby Mode

- **Local (default):** Transmitter can individually be activated.
- **Global:** All transmitters are activated at the same time from Standby mode.

⑨ Linking Preference

The Link procedure can be restricted to the control software by disabling the hardware Link button on the Networked Charging Station. By default, the Link button is enabled.

⑩ Identity Preference

Determines the way the transmitter responds when it is identified from the control software:

- **Enabled:** Beeps with flashing LEDs
- **Disabled:** Flashing LEDs only (no sound)

⑪ Language

Determines the language of the control software.

⑫ Password Setup

The default password for the device is 'admin'. The following describes access rights for each logon:

Admin (default): Full monitoring and editing access. The Admin can enable or disable the Tech- and Guest-level logon.

Tech: Monitoring with limited editing access.

Guest: Monitoring only.

⑬ Save/Load Preferences

Saves the preferences of the Configuration as a file to the computer. The file can be loaded and will overwrite the settings for all devices in the Configuration.

⑭ Register the Product Link

Links to Shure website for product registration.

Control Software for the MXW Audio Network Interface

The MXW Audio Network Interface features a control software to manage the analog inputs and outputs of the MXW system, in addition to the 4-port gigabit switch on the back panel of the network interface.

By default, all MXW devices have the password 'admin' applied to the control software. When logging in for the first time, enter 'admin' into the field to log on as the administrator. The password can be changed from the Preferences tab.

Note: For optimal system performance, the control software should not be open to more than seven tabs or windows.



Log On Page

① User

There are three security levels to the Control Software: Admin, Tech and Guest. By default, only Admin is enabled. Log on and go to the Preferences tab to manage the User log on.

Admin (default): Full editing rights. The Admin can enable or disable a Tech-level logon.

Tech: Partial editing rights, limited to microphone management on the Monitor tab.

Guest: Monitoring only.

② Password

Enter the password to log on as an Admin or Tech. The default password is 'admin' for the Admin user. To change the password, log on as an Admin and go to the Preferences tab.

③ Keep Me Logged On Button

When selected, this allows the user to bypass the Log On page when reopening the control software.

④ Language Selection

Selects the language for the GUI. This setting will be saved to the computer.

⑤ Log On Button

Press the button to log onto the control software.

Note: Default password is 'admin'

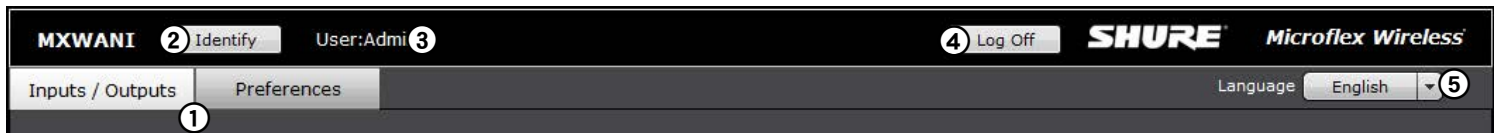

Control Bar

① Tabs

The software has an Inputs/Outputs tab for managing audio and a Preferences tab for system configurations.

② Identify Button

This button sends a command to the hardware to flash front-panel LEDs for easy identification.

③ Security Level

Displays the access level of the user: Administrator, Technician, or Guest.

④ Log Off

Logs the user out of the software.

⑤ Language Selection

Selects the language for the control software interface. This setting will be saved to the computer.

Inputs/Outputs Tab

The screenshot shows the SHURE Microflex Wireless software interface. At the top, there's a navigation bar with 'MXWANI', 'Identify', 'User:Admin', 'Log Off', and the SHURE logo. Below that, there are tabs for 'Inputs / Outputs' and 'Preferences', and a 'Language' dropdown set to 'English'. The main area is divided into 'Inputs (Returns)' and 'Outputs' sections. The 'Inputs' section has two columns, A and B, each with a channel name, gain settings for Line and Aux, an audio meter, and a Mute button. The 'Outputs' section has eight columns, each with a channel name, gain settings for Line, Aux, and Mic, an audio meter, an Attenuation (dBFS) control, and a Mute button. A 'Notes' section at the bottom contains a text input field. The interface includes a top navigation bar with 'MXWANI', 'Identify', 'User:Admin', 'Log Off', and the SHURE logo. A 'Language' dropdown is set to 'English'.

① Channel Name

Channel name is customizable by clicking in the text box. Names can be up to 12 characters long.

② Input Gain Setting (A, B)

Sets the analog input gain level: Line (default) or Aux.

③ Input Audio Meter

Displays input audio levels prior to the analog-to-digital converter.

④ Mute Button

Mutes or unmutes the channel's audio. The button illuminates red when a channel is muted.

⑤ Output Gain

Sets the output gain level.

⑥ Output Audio Meter

Displays output audio levels prior to the digital-to-analog converter.

⑦ Attenuation

Output attenuation is adjustable in 1 dB increments.

⑧ Notes

Save project notes here, such as installation dates or IP information.

Preferences Tab

The screenshot shows the 'Preferences' tab for an MXWANI device. The interface is organized into three columns: Device, Network, and Security. The 'Device' column contains settings for language, serial number, firmware version, and a factory reset button. The 'Network' column contains settings for audio routing mode, device name, IP configuration (mode, address, mask, gateway, MAC), and port 4 mode. The 'Security' column contains settings for front panel lockout and user access for Administrator, Technician, and Guest roles.

① Language

Selects the language for the control software when the ANI is in Standalone Mode. In Standalone Network mode, this is defined in the MXW System control software.

② Device Serial Number

Displays the devices serial number.

③ Firmware Version

Displays the current firmware version of the device.

④ Reset Button

Reboots the device with factory default settings.

⑤ Register This Product Link

Click to register the device at www.shure.com to receive product and software updates.

⑥ Audio Routing Mode

- **MXW Mode:** Enables automatic channel routing when the device is a part of an MXW group (assigned from the MXW System control software).
- **Standalone Mode:** Channels must be routed manually with Dante Controller software.

⑦ Device Name

Device names can be customized with up to 31 characters, except '=',',', or '@'.

⑧ Addressing Mode

Auto: IP settings are Link-Local or automatically accepted from a DHCP server.

Manual: IP settings (IP Address, Subnet Mask, and Gateway) are static and are entered manually.

⑨ MAC Address

Unique identifier assigned to each network interface.

⑩ Port 4 Mode

Configures the Port 4 of the network interface:

- **Switched Mode (default):** Full Ethernet support on port 4.
- **Uplink Mode:** Only control data is transported. Multicast traffic for Dante digital audio and the Shure Web Device Discovery application is restricted.

⑪ Front Panel Lockout

Disables the front panel controls on the hardware. Channels can still be selected for monitoring at the headphone jack.

⑫ Password

The default password for the device is 'admin'.

- **Admin (default):** Full editing rights. The Admin can enable or disable a Tech-level logon.
- **Tech:** Rights are limited to the Inputs/Outputs page (hardware functions only).
- **Guest:** Monitoring only.

Dante™ Software by Audinate

Audinate software provides additional function and control of the Dante™ digital audio network. Visit Audinate's website for instructions for download and installation.

Dante Controller

Dante Controller (DC) is free software by Audinate that is used to configure and manage a network of Dante devices. Use it to route channels between Dante-enabled devices and to monitor the status of the device, clock, and network.

Important: The MXWAPT must be the Dante clock master for the network. Do not change the clock master from the MXWAPT (default selection) to another device.

Note: DC software is not required for routing audio within the MXW system. Use caution when using DC, as changing settings may interfere with MXW system functionality.

Dante Virtual Soundcard

Dante Virtual Soundcard (DVS) acts as an audio driver used to monitor and record digital audio without additional equipment. DVS uses a computer's standard Ethernet ports to transmit and receive up to 64 channels from any Dante enabled device on the same network.

Firmware Updates

Firmware is embedded software in each component that controls functionality. Periodically, new versions of firmware are developed to incorporate additional features and enhancements. To take advantage of design improvements, new versions of the firmware can be uploaded and installed using the Firmware Manager tool. Software is available for download from <http://www.shure.com>.

Perform the following steps to update the firmware:

CAUTION! Ensure the device has a stable network connection during the update. Do not turn off the device until the update is complete.

1. Connect the device and computer to the same network (set to the same subnet).
 - To update MXW transmitters, place them in an MXW Networked Charging Station that is connected to the network.
 - If the MXW Audio Network Interface is connected via Port 4, ensure that the Network mode is set to Switched mode (default) from the Preferences tab of the ANI control software.
2. Download Shure Update Utility app and install it.
3. Open the application.
4. Click **Check For Updates . . .** button to view new firmware versions available for download.
5. Select the desired firmware and press **Download** to download it to the Firmware Library.
6. From the **Update Devices** tab, select the new firmware and press **Send Updates . . .** to begin the firmware update, which overwrites the existing firmware on the device.

Firmware Release Requirements

Microflex Wireless devices comprise a network with multiple communications protocols that work together to ensure proper operation. The recommended best practice is that all MXW devices are on an identical release. To view the firmware of each MXW device on the network, open the Utility page of the MXW control software.

The format for Shure device's firmware is MAJOR.MINOR.PATCH. (Ex. 1.6.2 where 1 is the Major firmware level, 6 is the Minor firmware level, and 2 is the Patch firmware level.) At minimum, devices that operate on the same subnet should have identical MAJOR and MINOR release numbers.

- Devices of different MAJOR releases are not compatible.
- Differences in the PATCH firmware release level may introduce undesired inconsistencies.

Additional Topics

- **Connecting to an External Control System** 54
- **NCS Mounting Template** 54
- **Troubleshooting** 55
 - Additional Resources
 - Factory Reset
- **MXW Accessories and Part Numbers** 57

Connecting to an External Control System

The MXW System connects to an AMX or Crestron control system via the Ethernet. Use only one controller per system to avoid messaging conflicts. For a comprehensive list of MXW command strings, visit: http://shure.custhelp.com/app/answers/detail/a_id/5207

- Connection: Ethernet (TCP/IP; MXW is the client)
- Port: 2202

Screw Kit for MXW Chargers

This kit provides washers and screws for securing a charging tray to a table or other surface. Use two kits for the NCS8. Please refer to the NCS mounting template for screw hole placement.

Important: The top of the screw must extend **exactly** $\frac{9}{64}$ (0.149) inches (3.78 mm) above the surface (about 4½ threads).

- Use the screws that best fit the thickness of the table.
- Use a lock washer and flat washer for each screw.
- If necessary, counterbore the screw head or add additional flat washers.

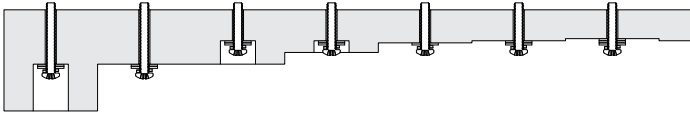
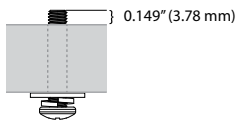

Required Thread Exposure

Use counterbore and washers as necessary depending on thickness of table

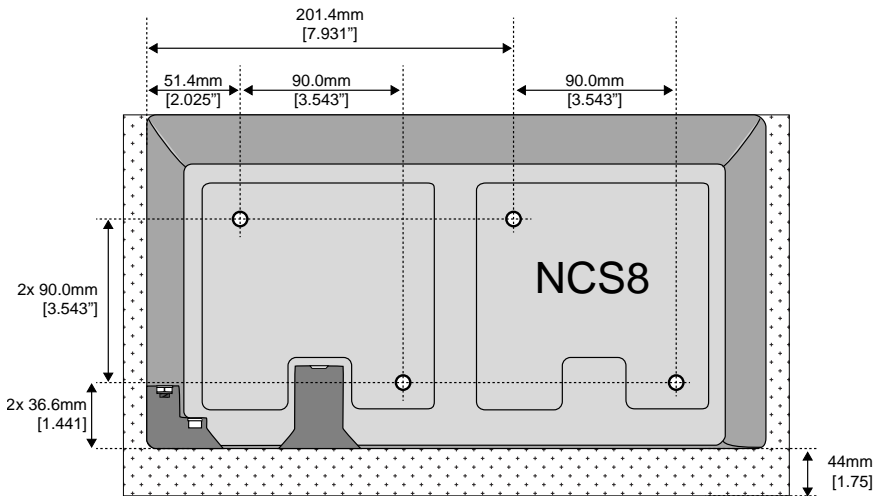

Leave space behind the charger for cabling

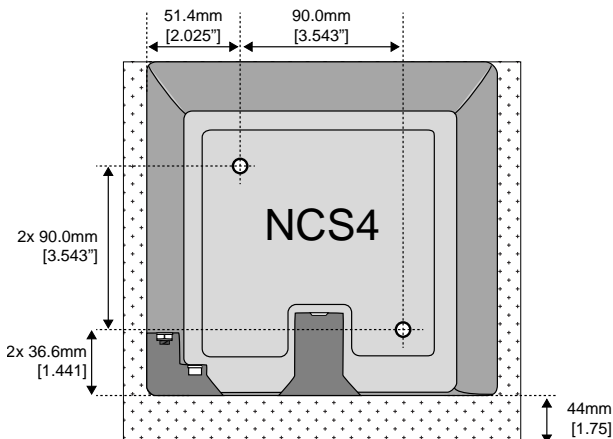

NCS Mounting Template

Troubleshooting

The following table offers typical solutions when troubleshooting the Microflex Wireless System. For more information on each topic, reference the full MXW User Guide found on www.shure.com and bundled with the USB Flash Drive.

Audio

| Problem | Indicator | Solution | |
|--|--|---|---|
| No/ Distorted audio | Network Audio LED on the Audio Network Interface or SCM820 | Green | <ul style="list-style-type: none"> • Check cables • Check that transmitters are on and channels are un-muted • Check that the input meters are OK on the Monitor tab of the MXW control software. Attenuate if the channel is clipping. • Check the output meters on the Audio Network Interface (ANI) front panel and in the ANI control software. Use headphones to listen to the audio from the ANI. Attenuate if the channel is clipping. • Check that the output level of the ANI matches the input of the connecting equipment. • Verify APT is not performing a spectrum scan. |
| | | Flashing Green | <ul style="list-style-type: none"> • Ensure all devices are on and have a stable network connection • Use Dante Controller software (DC) to verify channel subscriptions |
| | | Red | <ul style="list-style-type: none"> • Check master clock in DC (an MXWAPT must be master clock) |
| | | Off | <ul style="list-style-type: none"> • Place the device in a Group to automatically route the audio • Ensure the subnet of the Access Point Transceiver's network audio settings match the subnet of the Audio Network Interface |
| RF Interference is causing audio drop-outs | Audio is intermittent | <ul style="list-style-type: none"> • Perform a Spectrum Scan to monitor RF interference • Decrease channel count to verify if system is overloading the RF spectrum | |

System Setup and MXW Groups

| Problem | Indicator | Solution |
|--------------------------------------|---|--|
| Can't associate component to a Group | Device drop-down not displaying the desired component in the Group row on the Configuration tab | <ul style="list-style-type: none"> • Check that devices are powered and connected to the same network and subnet) • Open the Utility tab of the MXW Control Software and un-check the Configuration Filter to display all MXW devices on the network. If the device shows up as "OTHER", then it is part of another Configuration. • Un-associate the component by selecting 'none' from the Group row in the other Configuration. • Perform a factory reset on the device to clear any association. |

Network

| Problem | Indicator | Solution |
|---|--|---|
| Can't Connect to the Control Software from a PC | Device not appearing in Shure Web Device Discovery application | <ul style="list-style-type: none"> • Ensure the devices are powered • Ensure PC and equipment are on the same network and set to the same subnet • Turn off other network interfaces not used to connect to the device (including WiFi) • Check that DHCP server is functioning (if applicable) • Ensure Bonjour is running on the PC • If connected via Port 4 of the Audio Network Interface (ANI), ensure it is set to Switched Mode. |
| Control Software is taking a long time to load | Web browser cannot connect to the control interface | <ul style="list-style-type: none"> • Download latest version of Adobe® Flash® • Ensure PC and device are on the same network and subnet • Check that Windows firewall settings are not blocking Shure software • Set the router to not send default gateway as a part of DHCP • Set the Shure Web Device Discovery application to open by IP address • Manually set the computer to a static IP address on the same network as the device |
| Control Software is performing poorly | Indicators are moving slowly or not displaying in real time. | <ul style="list-style-type: none"> • Reduce the number of windows or tabs that are open to the same Configuration • See Network section for properly setting up the network |

Additional Resources

For additional Troubleshooting assistance or further information on complex installations, contact Shure to speak with a support representative. In the Americas region, call Systems Support group at 847-600-8440. For users in other locations, go to www.shure.com to find support contact for your region.

For digital audio networking help, advanced networking guidelines and Dante software troubleshooting, visit Audinate's website at www.audinate.com.

Factory Reset

If a device isn't appearing on the network after trying troubleshooting methods, perform a reset on the specific hardware to return the device to default settings. Factory default settings are designed for automatic compatibility with other Shure networked devices.

Note: A factory reset will clear any MXW Group and Link associations. The password to access the software will reset to **admin**.

From the Control Software

1. Open the Utility Tab of the MXW control software.
2. Select the Edit Properties button for the device.
3. Select the factory reset check-box.
4. Select Add Updates to save the setting to the edits queue.
5. Repeat for any additional devices.
6. Press the Apply All to make changes to all devices with edited properties.

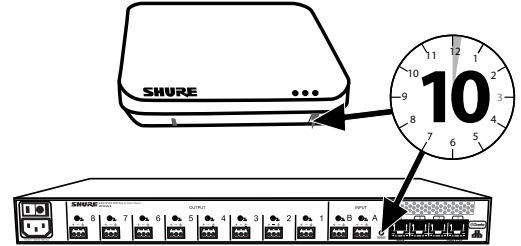

From the Hardware

Access Point Transceiver

Press and hold the recessed reset button for 10 seconds. The network audio status LED will briefly turn off to indicate the unit is rebooting.

CAUTION: A factory reset deletes all Group associations and microphone Links saved in the device.

Audio Network Interface

Press and hold the reset button for 10 seconds. The front panel LEDs will flash to indicate the unit is rebooting.

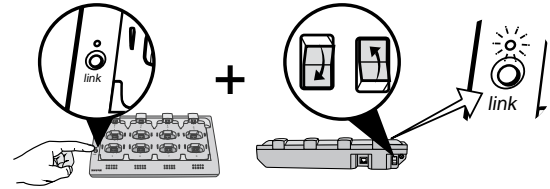

Networked Charging Station

- a. Turn off the power switch.
- b. Press and hold the Link button.
- c. While holding the Link button, turn on the power switch.
- d. Continue to hold the Link button for 12 seconds until the LED illuminates amber.

MXW Accessories and Part Numbers

| Component | Accessory | Part Number | |
|--------------------------|---|---|-----------------------------|
| Access Point Transceiver | 8-Channel Access Point Transceiver | MXWAPT8 | |
| | 4-Channel Access Point Transceiver | MXWAPT4 | |
| | USB Drive (Shure Web Device Discovery application, Shure Firmware Update Manager application, User manuals) | 90A20081 | |
| | Mounting Plate | 65A20030 | |
| | Paintable Cover | 65A20030 | |
| Audio Network Interface | 8-Channel Audio Network Interface | MXWANI8 | |
| | 4-Channel Audio Network Interface | MXWANI4 | |
| | Hardware Kit | 90A20082 | |
| | IEC Cable | Varies by region; see table | |
| Network Charging Station | 8-Channel Audio Network Interface | MXWNCS8 | |
| | 4-Channel Audio Network Interface | MXWNCS4 | |
| | Power Supply | PS45 | |
| Transmitter | Bodypack Transmitter | MXW bodypack transmitter (without lavalier microphone) | MXW1/O |
| | | Lavalier microphone | See table |
| | Handheld | SM58 | MXW2/SM58 |
| | | SM86 | MXW2/SM86 |
| | | Beta58 | MXW2/BETA58 |
| | | VP868 | MXW2/VP868 |
| | Boundary | Omnidirectional | MXW6/O |
| | | Cardioid | MXW6/C |
| | Gooseneck Base | MXW gooseneck base transmitter (without gooseneck microphone) | MXW8 |
| | | Gooseneck microphone | see table |
| | USB Charger | | Varies by region; see table |
| | Mono Earpiece/Volume Control | | DH 6125+VC |
| | Anti-Roll Ring for MXW2 | | A1K |

Lavalier Options

| Microphone Description | Part Number |
|--|--------------|
| Microflex® 5mm Subminiature Lavalier, Omnidirectional, Black | MX150B/O-TQG |
| Microflex® 5mm Subminiature Lavalier, Cardioid, Black | MX150B/C-TQG |
| Microflex® Omnidirectional Subminiature Earset, Black | MX153B/O-TQG |
| Microflex® Omnidirectional Subminiature Earset, Tan | MX153T/O-TQG |
| Microflex® Omnidirectional Subminiature Earset, Cocoa | MX153C/O-TQG |
| Microflex® 1cm Omnidirectional Lavalier, Black | WL183 |
| Microflex® 1cm Supercardioid Lavalier, Black | WL184 |
| Microflex® 1cm Cardioid Lavalier, Black | WL185 |
| Omnidirectional Condenser Miniature Lavalier, Black | WL93 |
| Countryman, 3mm Subminiature Omnidirectional Lavalier, Black | WCB6B |
| Countryman, Omnidirectional Rigid Earset Microphone, Black | WCE6B |
| Countryman, Omnidirectional Rigid Earset Microphone, Tan | WCE6T |

Gooseneck Options

| Microphone Description | Polar Pattern | Length | Part Number |
|-------------------------------|-----------------------|----------------|-------------|
| Bi-color LED status indicator | Cardioid | 5" (12.7 cm) | MX405LP/C |
| | Supercardioid | 5" (12.7 cm) | MX405LP/S |
| | Cardioid | 10" (25.4 cm) | MX410LP/C |
| | Supercardioid | 10" (25.4 cm) | MX410LP/S |
| | Cardioid | 15" (38.1 cm) | MX415LP/C |
| | Supercardioid | 15" (38.1 cm) | MX415LP/S |
| Light ring indicator | No cartridge included | 5" (12.7 cm) | MX405RLP/N |
| | | 10" (25.4 cm) | MX410RLP/N |
| | | 15" (38.1 cm) | MX415RLP/N |
| Capsule only | Cardioid | for any length | R185B |
| | Supercardioid | for any length | R184B |

IEC Power Cable

| Power Cable by Region | Part Number |
|-----------------------|-------------|
| USA | 95B8389 |
| Brazil | 95A14336 |
| Argentina | 95A14335 |
| Europe | 95C8247 |
| UK | 95A8713 |
| Japan | 95B9021 |
| China | 95B9073 |
| Korea | 95B9074 |
| Australia | 95A9128 |

USB Charger

| USB Charger by Region | Part Number |
|-----------------------|-------------|
| USA | SBC-USB-A |
| UK | SBC-USBUK-A |
| Europe | SBC-USBE-A |
| Australia | SBC-USBAZ-A |
| Japan | SBC-USBJ-A |
| Taiwan | SBC-USBTW-A |
| Brazil | SBC-USBR-A |

Microflex Wireless Specifications

System

RF Carrier Frequency Range

| Band | Region | Frequency Range |
|------|---------------------------|-----------------|
| Z10 | USA, Canada, Mexico | 1920–1930 MHz |
| Z11 | Europe, Asia, Middle-East | 1880–1900 MHz |
| Z12 | Japan | 1893–1905 MHz |
| Z15 | Taiwan | 1880–1895 MHz |
| Z14 | Brazil | 1910–1920 MHz |

Working Range

50 m (160 ft)

Note: Actual range depends on RF power setting, signal absorption, reflection, and interference.

Audio Frequency Response

50 Hz – 20 kHz (+1, -3 dB)

Note: Dependent on microphone type

Dynamic Range

>99 dB, A-weighted

System Gain

Mic gain @ 0dB to line level output on MXWANI through Dante

+50 dB

Latency

18 ms, nominal

System Audio Polarity

Positive pressure on microphone diaphragm (or positive voltage on pin 3 of TA4M connector) produces a positive voltage on pin 2 of the ANI (with respect to pin 3 of the low-impedance output).

Radio Transmission

Time Division Multiple Access (TDMA), Gaussian Frequency Shift Keying (GFSK), 365 kHz max. deviation

RF Sensitivity

-87 dBm, minimum

Power

19 dBm (80 mW) maximum, See Frequency Range and Output Power table

Cable Requirements

Cat 5e or higher, shielded, 100 m maximum between network devices

Network Addressing Capability

DHCP, link-local, static

Operating Temperature Range

0°C (32°F) to 49°C (120°F)

Storage Temperature Range

-29°C (-20°F) to 74°C (165°F)

Transmitters

Gain Adjustment Range

-25 to +15 dB (in 1 dB steps)

Maximum Input Level

Mic gain @ -16 dB

-9 dBV

Headphone Output

3.5 mm (1/8"), dual mono (will drive stereo phones)

Maximum Headphone Output Power

1kHz @ 1% distortion, peak power, @16Ω

17.5 mW

Antenna Type

Internal, Spatial Diversity, Linear Polarization

Antenna Gain

| | |
|---------|----------|
| Average | -1.1 dBi |
| Peak | 0.5 dBi |

Battery Type

Rechargeable Li-Ion

Battery Life

| | |
|------------------|----------------|
| MXW1, MXW6, MXW8 | Up to 9 hours |
| MXW2 | Up to 15 hours |

Calculated with a new battery. Runtimes vary depending on battery health.

Charge Connector

USB 3.0 Type A

Housing

Molded Plastic

Recommended Storage Temperature Range

0°C (32°F) to 25°C (77°F)

MXW1 Hybrid Bodypack Transmitter

Microphone Connector

4-Pin male mini connector (TA4M), See drawing for details

Input Impedance

@ 1 kHz

>20 kΩ

Internal Microphone

Omnidirectional (20 Hz – 20 kHz)

Dimensions

22 mm x 45 mm x 99 mm (0.9 in. x 1.8 in. x 3.9 in.) H x W x D

Weight

85 g (3.0 oz.)

with batteries, without microphone

MXW2 Handheld Transmitter

Microphone Capsule

SM58, SM86, Beta58, VP68

Configuration

Unbalanced

Input Impedance

@ 1 kHz

>20 kΩ

Dimensions

226 mm x 51 mm (8.9 in. x 2.0 in.) L x Dia.
including SM58 microphone capsule

Weight

323 g (11.4 oz.)

with batteries, including SM58 microphone capsule

MXW6 Boundary Transmitter

Microphone Capsule

| | |
|--------|-------|
| MXW6/O | R183B |
| MXW6/C | R185B |

Dimensions

23 mm x 44 mm x 114 mm (0.9 in. x 1.75 in. x 4.5 in.) H x W x D

Weight

108 g (3.8 oz.)

with batteries

MXW8 Gooseneck-Base Transmitter

Microphone Connector

6-pin connector for Shure MX405/10/15

Configuration

Unbalanced

Input Impedance

@ 1 kHz

>20 kΩ

Gooseneck Options

See accessories list

Dimensions

36 mm x 71 mm x 124 mm (1.4 in. x 2.8 in. x 4.9 in.) H x W x D

Weight

193 g (6.8 oz.)

with batteries, without microphone

Access Point Transceiver (APT)

Network Interface

RJ45: Gigabit Ethernet, Dante digital audio

Plenum Rating

UL 2043

Power Requirement

Power over Ethernet (PoE) Class 0, 6.5W

Antenna Type

Internal, Spatial Diversity, Circular Polarization

Antenna Gain

| | |
|---------|---------|
| Average | 0.5 dBi |
| Peak | 3.0 dBi |

Housing

Molded Plastic, Cast Zinc

Dimensions

24 mm x 170 mm x 170 mm (1.35 in. x 6.7 in. x 6.7 in.), H x W x D
Without mounting plate or cover

Weight

| | |
|------------------|-----------------|
| APT8 | 856 g (1.9 lbs) |
| APT4 | 845 g (1.9 lbs) |
| Paintable Cover | 85 g (0.2 lbs) |
| Mounting Bracket | 68 g (0.15 lbs) |

Networked Charging Station (NCS)

Charge Time

| | |
|------------------|----------------------------|
| MXW1, MXW6, MXW8 | 50%=1 hour; 100%=2 hours |
| MXW2 | 50%=1.5 hour; 100%=3 hours |

Network Interface

10/100 Mbps Ethernet

Power Requirement

15 V DC @ 3.3 A maximum, supplied by external power supply (tip positive)

Housing

Molded Plastic, Cast Zinc

Dimensions

| | |
|------|--|
| NCS8 | 68 mm x 343 mm x 184 mm (2.7 in. x 13.5 in. x 7.25 in.), H x W x D |
| NCS4 | 68 mm x 191 mm x 184 mm (2.7 in. x 7.5 in. x 7.25 in.), H x W x D |

Weight

| | |
|------|------------------|
| NCS8 | 2.9 kg (6.4 lbs) |
| NCS4 | 1.7 kg (3.7 lbs) |

Audio Network Interface (ANI)

Audio Frequency Response

20 Hz to 20 kHz (+1, -1.5 dB)

Dynamic Range

20 Hz to 20 kHz, A-weighted, typical

| | |
|-----------------|--------|
| Analog-to-Dante | 113 dB |
| Dante-to-Analog | 110 dB |

Output Noise

20 Hz to 20 kHz, A-Weighted, typical

| Line | Aux | Mic |
|-----------|-----------|------------|
| -84.5 dBV | -95.2 dBV | -106.5 dBV |

THD+N

20 Hz to 20 kHz+4dBu analog input, -10 dBFS digital input
<0.05%

Polarity

Non-inverting, any input to any output

Dimensions

44 mm x 483 mm x 366 mm (1.7 in. x 19.0 in. x 14.4 in.), H x W x D

Weight

| | |
|---------|------------------|
| MXWANI4 | 3.1 kg (6.9 lbs) |
| MXWANI8 | 3.2 kg (7.1 lbs) |

Housing

Steel; Extruded aluminum

Power Requirements

100 to 240 V AC, 50-60 Hz, 1 A

Operating Temperature Range

-18°C (0°F) to 63°C (145°F)

Storage Temperature Range

-29°C (-20°F) to 74°C (165°F)

Analog Connections

Outputs

| Configuration | Impedance | Clipping Level (minimum) | | |
|-----------------|-----------|--------------------------|-----------|----------|
| | | Line | Aux | Mic |
| Active Balanced | 310 Ω | +26.2 dBV | +16.2 dBV | -3.8 dBV |

Input(s)

| Configuration | Impedance | Clipping Level (minimum) | |
|-----------------|-----------|--------------------------|-----------|
| | | Line | Aux |
| Active Balanced | 10.6 kΩ | +23.8 dBV | +10.8 dBV |

Headphone Output

6.35 mm (1/4") TRS, 100 mW, 350 Ω, dual mono (will drive stereo phones)

0 dBV=1 V RMS

0 dBu=0.775 V RMS

0 dBV=2.2 dBu

Digital Signal Processing

AD/DA Converter

24-bit, 48 kHz

Latency

Estimated Nominal, ±0.1 ms

| | |
|-----------------|--------------|
| Analog-to-Dante | 0.21 ms |
| Dante-to-Analog | 0.24 ms + TN |

TN = Network latency in milliseconds, as set in Dante Controller.

Note: Dante network latency is typically associated with the receiving device.

Networking

Network Interface

Four-Port Gigabit Ethernet Switch, Dante digital audio

Uplink Port (Port 4)

Selectable, blocks multicast traffic

Power over Ethernet (PoE)

Provided on Port 1 to power MXWAPT

Cable Requirements

Cat 5e or higher, shielded, 100 m maximum between network devices

Network Addressing Capability

DHCP, link-local, static

Transmitter Output Power

Bands: Z10, Z11, Z13, Z15

MXW1

| Setting | dBm | mW |
|---------|-----|----|
| Low | -2 | 1 |
| Medium | 5 | 3 |
| High | 12 | 16 |
| Maximum | 17 | 50 |

MXW2

| Setting | dBm | mW |
|---------|-----|----|
| Low | 0 | 1 |
| Medium | 7 | 5 |
| High | 12 | 16 |
| Maximum | 17 | 50 |

MXW6, MXW8

| Setting | dBm | mW |
|---------|-----|----|
| Low | -2 | 1 |
| Medium | 5 | 3 |
| High | 12 | 16 |
| Maximum | 19 | 80 |

Band: Z12

MXW1, MXW6, MXW8

| Setting | dBm | mW |
|---------|-----|----|
| Low | 0 | 1 |
| Medium | 5 | 3 |
| High | 9 | 8 |
| Maximum | 12 | 16 |

MXW2

| Setting | dBm | mW |
|---------|-----|----|
| Low | 0 | 1 |
| Medium | 7 | 5 |
| High | 9 | 8 |
| Maximum | 12 | 16 |

Wiring Diagram

TA4M Connector

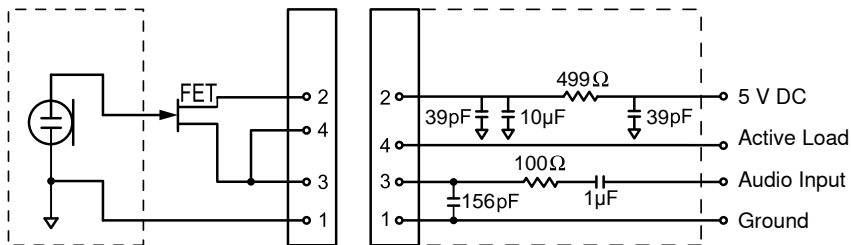

Top view of bodypack



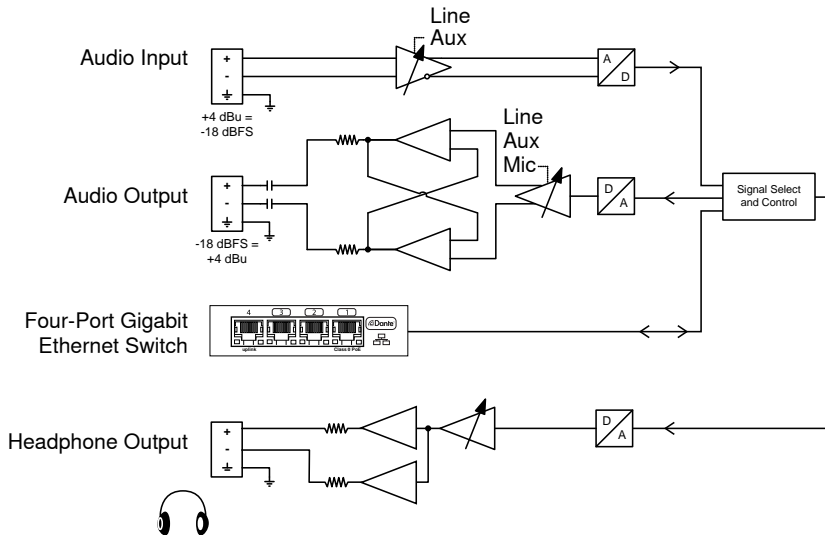

Audio Network Interface (ANI)



Safety Information

SAFETY PRECAUTIONS

The possible results of incorrect use are marked by one of the two symbols—"WARNING" and "CAUTION"—depending on the imminence of the danger and the severity of the damage.

| | |
|---|--|
|  | WARNING: Ignoring these warnings may cause severe injury or death as a result of incorrect operation. |
|  | CAUTION: Ignoring these cautions may cause moderate injury or property damage as a result of incorrect operation. |

WARNING

LISTENING TO AUDIO AT EXCESSIVE VOLUMES CAN CAUSE PERMANENT HEARING DAMAGE. USE AS LOW A VOLUME AS POSSIBLE. Over exposure to excessive sound levels can damage your ears resulting in permanent noise-induced hearing loss (NIHL). Please use the following guidelines established by the Occupational Safety Health Administration (OSHA) on maximum time exposure to sound pressure levels before hearing damage occurs.

| | | | |
|--------------------------------|------------------------------------|--|--------------------------------|
| 90 dB SPL at 8 hours | 95 dB SPL at 4 hours | 100 dB SPL at 2 hours | 105 dB SPL at 1 hour |
| 110 dB SPL at ½ hour | 115 dB SPL at 15 minutes | 120 dB SPL Avoid or damage may occur | |

WARNING

- Battery packs may explode or release toxic materials. Risk of fire or burns. Do not open, crush, modify, disassemble, heat above 140°F (60°C), or incinerate.
- Follow instructions from manufacturer
- Only use Shure charger to recharge Shure rechargeable batteries
- **WARNING:** Danger of explosion if battery incorrectly replaced. Replace only with same or equivalent type.
- Never put batteries in mouth. If swallowed, contact your physician or local poison control center
- Do not short circuit; may cause burns or catch fire
- Do not charge or use battery packs other than Shure rechargeable batteries
- Dispose of battery packs properly. Check with local vendor for proper disposal of used battery packs.
- Batteries (battery pack or batteries installed) shall not be exposed to excessive heat such as sunshine, fire or the like

WARNING: Danger of explosion if battery incorrectly replaced. Operate only with Shure compatible batteries.

Note: Use only with the included power supply or a Shure-approved equivalent.

1. 經審驗合格之射頻電信終端設備，非經許可，公司、商號或使用者均不得擅自變更頻率、加大功率或變更原設計之特性及功能。
2. 射頻電信終端設備之使用不得影響飛航安全及干擾合法通信；經發現有干擾現象時，應立即停用，並改善至無干擾時方得繼續使用。所謂合法通信，係指依電信法規定作業之無線電信。
3. 輸入、製造射頻電信終端設備之公司、商號或其使用者違反本辦法規定，擅自使用或變更無線電頻率、電功率者，除依電信法規定處罰外，國家通訊傳播委員會並得撤銷其審驗合格證明。
4. 減少電磁波影響，請妥適使用

MXW1

Bodypack Microphone Transmitters:

These transmitters have been tested and found to comply with international radiation exposure limits set forth for an uncontrolled environment. This equipment is in direct contact with the body of the user under normal operating conditions. These transmitters must not be co-located or operating in conjunction with any other antenna or transmitter.

MXW2, MXW6, MXW8, MXWAPT4, MXWAPT8

Handheld Microphone Transmitters, Tabletop Boundary Microphone Transmitters, Tabletop Gooseneck Microphone Transmitters, Wireless Access Point Transmitters:

These mobile transmitters are intended for use at distances greater than 20 centimeters from the human body. These mobile transmitters are exempt from the testing requirements of international radiation exposure standards due to their proximity to the body of the user in their intended use case and their low power output. These mobile transmitters shall be placed or installed at least 20 cm from any person and must not be co-located or operating in conjunction with any other antenna or transmitter.

Important Product Information

The equipment is intended to be used in professional audio applications.

EMC conformance testing is based on the use of supplied and recommended cable types. The use of other cable types may degrade EMC performance.

Changes or modifications not expressly approved by Shure Incorporated could void your authority to operate this equipment.

Please follow your regional recycling scheme for batteries, packaging, and electronic waste.

Note: This device is not intended to be connected directly to a public internet network.

Information to the user

This equipment has been tested and found to comply with the limits for a Class B digital device, pursuant to Part 15 of the FCC Rules. These limits are designed to provide reasonable protection against harmful interference in a residential installation. This equipment generates uses and can radiate radio frequency energy and, if not installed and used in accordance with the instructions, may cause harmful interference to radio communications. However, there is no guarantee that interference will not occur in a particular installation. If this equipment does cause harmful interference to radio or television reception, which can be determined by turning the equipment off and on, the user is encouraged to try to correct the interference by one or more of the following measures:

- Reorient or relocate the receiving antenna.
- Increase the separation between the equipment and the receiver.
- Connect the equipment to an outlet on a circuit different from that to which the receiver is connected.
- Consult the dealer or an experienced radio/TV technician for help.

Certifications

This device complies with FCC Part 15.

This device complies with Industry Canada licence-exempt RSS standard(s). Operation of this device is subject to the following two conditions: (1) this device may not cause interference, and (2) this device must accept any interference, including interference that may cause undesired operation of the device.

Le présent appareil est conforme aux CNR d'Industrie Canada applicables aux appareils radio exempts de licence. L'exploitation est autorisée aux deux conditions suivantes : (1) l'appareil ne doit pas produire de brouillage, et (2) l'utilisateur de l'appareil doit accepter tout brouillage radioélectrique subi, même si le brouillage est susceptible d'en compromettre le fonctionnement.

Japanese Radio Law and Japanese Telecommunications Business Law Compliance. This device is granted pursuant to the Japanese Radio Law (電波法) and the Japanese Telecommunications Business Law (電気通信事業法). This device should not be modified (otherwise the granted designation number will become invalid).

Conforms to electrical safety requirements based on IEC 60065.

This product meets the Essential Requirements of all relevant European directives and is eligible for CE marking.

The CE Declaration of Conformity can be obtained from Shure Incorporated or any of its European representatives. For contact information please visit www.shure.com

The CE Declaration of Conformity can be obtained from: www.shure.com/europe/compliance

Authorized European representative:
Shure Europe GmbH
Headquarters Europe, Middle East & Africa
Department: EMEA Approval
Jakob-Dieffenbacher-Str. 12
75031 Eppingen, Germany
Phone: 49-7262-92 49 0
Fax: 49-7262-92 49 11 4
Email: info@shure.de

MXWNCS4, MXWNCS8

Authorized under the FCC verification provision per Part 15b.

Industry Canada ICES-003 Compliance Label:

CAN ICES-3 (B)/NMB-3(B)

Note: See the label located on the bottom side of the charger enclosure for the FCC marking, the CE marking, the C-Tick marking, and the electrical ratings.

MXW1, MXW2, MXW6, MXW8, MXWAPT4, MXWAPT8

Certified under FCC Part 15.

FCC: DD4MXW1, DD4MXW2, DD4MXW6, DD4MXW8, DD4MXWAPT4, DD4MXWAPT8.

Meets applicable requirements of RSS-213.

IC: 616A-MXW1, 616A-MXW2, 616A-MXW6, 616A-MXW8, 616A-MXWAPT4, 616A-MXWAPT8.

Trademarks

Audinate®, the Audinate logo and Dante are trademarks of Audinate Pty Ltd.

SHURE[®]
LEGENDARY
PERFORMANCE™

United States, Canada,
Latin America, Caribbean:
Shure Incorporated
5800 West Touhy Avenue
Niles, IL 60714-4608 USA

Phone: +1 847-600-2000
Fax: +1 847-600-1212 (USA)
Fax: +1 847-600-6446
Email: info@shure.com
www.shure.com

Europe, Middle East, Africa:
Shure Europe GmbH
Jakob-Dieffenbacher-Str. 12,
75031 Eppingen, Germany

Phone: +49-7262-92490
Fax: +49-7262-9249114
Email: info@shure.de
www.shure.eu

Asia, Pacific:
Shure Asia Limited
22/F, 625 King's Road
North Point, Island East
Hong Kong

Phone: +852-2893-4290
Fax: +852-2893-4055
Email: info@shure.com.hk
www.shureasia.com