

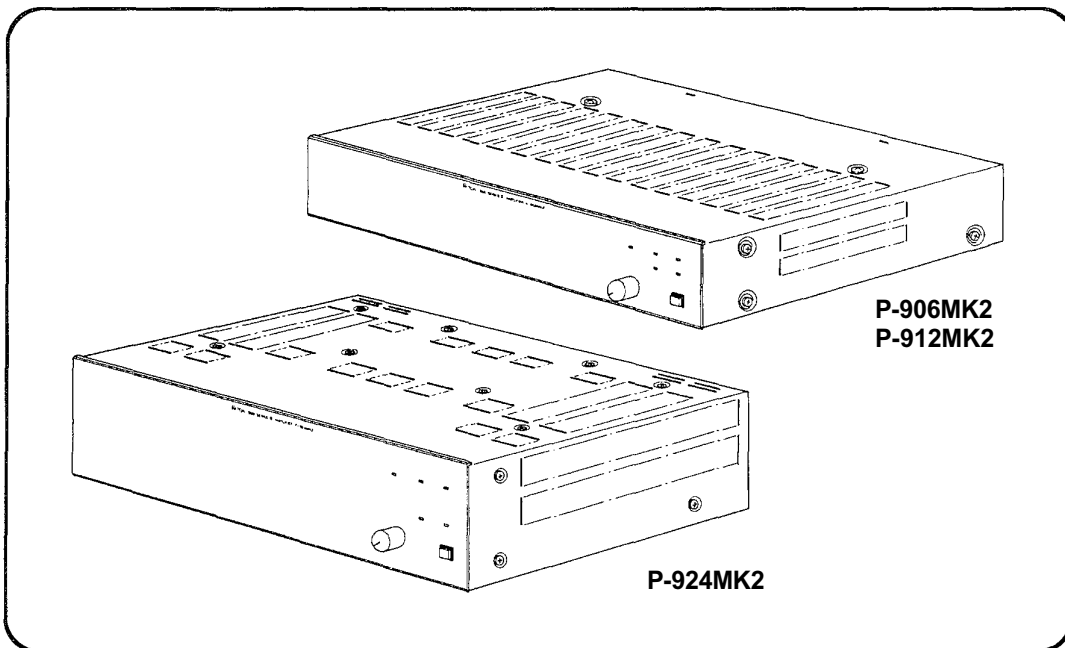



Operating Instructions

TOA 900 SERIES II POWER AMPLIFIER

P-906MK2
P-912MK2
P-924MK2



	CAUTION RISK OF ELECTRIC SHOCK DO NOT OPEN	
<p>TO REDUCE THE RISK OF ELECTRICAL SHOCK, DO NOT REMOVE COVER. NO USER SERVICEABLE PARTS INSIDE. REFER SERVICING TO QUALIFIED SERVICE PERSONNEL.</p>		



THE LIGHTNING FLASH WITH ARROWHEAD WITHIN A TRIANGLE IS INTENDED TO TELL THE USER THAT PARTS INSIDE THE PRODUCT ARE A RISK OF ELECTRIC SHOCK TO PERSONS.



THE EXCLAMATION POINT WITHIN A TRIANGLE IS INTENDED TO TELL THE USER THAT IMPORTANT OPERATING AND SERVICING INSTRUCTIONS ARE IN THE PAPERS WITH THE APPLIANCE.

Please follow the instructions in this manual to obtain the optimum results from this unit.
We also recommend that you keep this manual handy for future reference.

TOA Corporation

■ Contents

General description	2
Features	2
Nomenclature	
Front panel	3
Rear panel	4
Input connections	5
Output connections	6
Rack mounting	7
Operation	8
Volume adjustment	8
Installation	8
Servicing	8
Specifications	9
Appearance (P-906MK2/P-912MK2)	10
Appearance (P-924MK2)	11

■ General Description

The TOA P-906MK2, P-912MK2 and P-924MK2 Power Amplifiers deliver up to 60 watts, 120 watts and 240 watts of power respectively at less than 0.5% total harmonic distortion (THD) from 20 to 20,000 Hz (transformerless 4-ohm output). The power amplifiers have a high-impedance direct input and an input port (edge connector) to accept one plug-in module. Module selection is determined by application among the TOA plug-in modules.

The power amplifiers have a low-cut switch for a cutoff frequency of 60 Hz, and an input-level switch for input sensitivity of 1V (0 dBV) or 100mV (-20 dBV). Output terminals provide connections for 4-ohm and 8-ohm speakers, plus 25-volt and 70-volt speaker distribution outlets. With plug-in modules, the power amplifiers may be used as a PA amplifier.

The power amplifiers can be rack mounted by using optional rack mounting bracket MB-25B(P-906MK2, P-912MK2) and MB-35B(P-924MK2). The optional perforated panel PF-511 provides suitable ventilation, finished in color to match the power amplifiers.

■ Features

1. Wide frequency response : 20 ~ 20,000 Hz \pm 1 dB
2. Low distortion and noise level
3. Excellent output regulation
4. A full range of plug-in modules
5. Self-protecting circuitry design
6. Varied output impedances : 4 ohms, 8 ohms, 25 and 70 volts
7. Input level switch (selectable 1000 mV/100 mV)
8. Portable or rack mounting type

■ Nomenclature

< Front Panel >

P-906MK2, P-912MK2

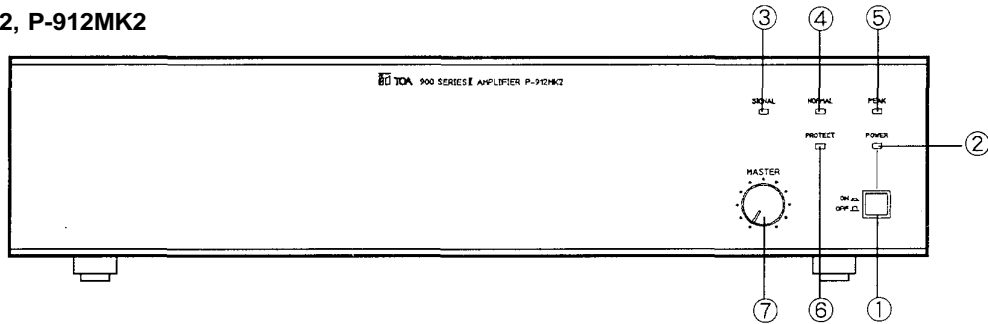

P-924MK2

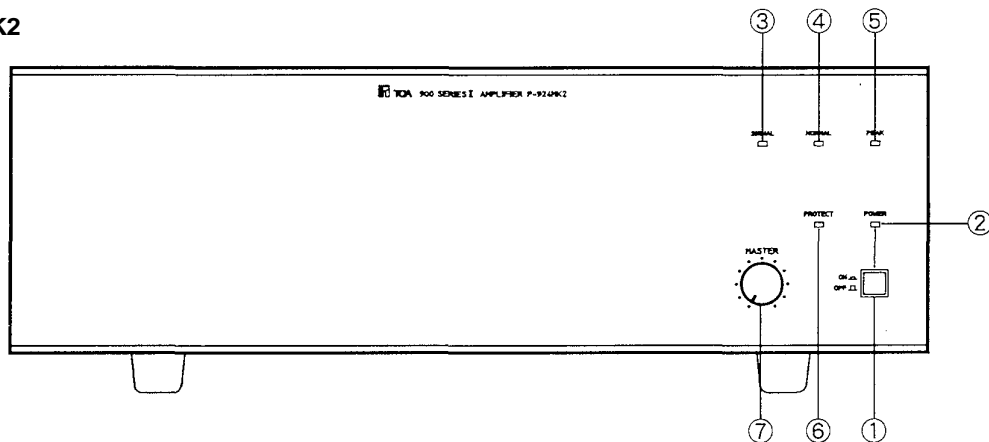

① Power Switch

Applies line power. Two-position push button switch for on/off modes.

② Power Indicator LED

Green LED lights when the power is switched "ON".

③ Signal Indicator LED

Green LED lights when more than -30 dB signal level is fed to the inputs by means of the master volume control.

④ Normal Indicator LED

Yellow LED lights when fed to the proper signal level.

⑤ Peak Indicator LED

Red LED lights when amplifier approaches clipping level. If steady lit, the input level control should be turned down until the LED flashes.

⑥ Protection Indicator LED

Remains lit for about 5 seconds after power switch is turned ON.

⑦ Master Volume Control

Adjust gain of input.

< Rear Panel >

P-906MK2, P-912MK2

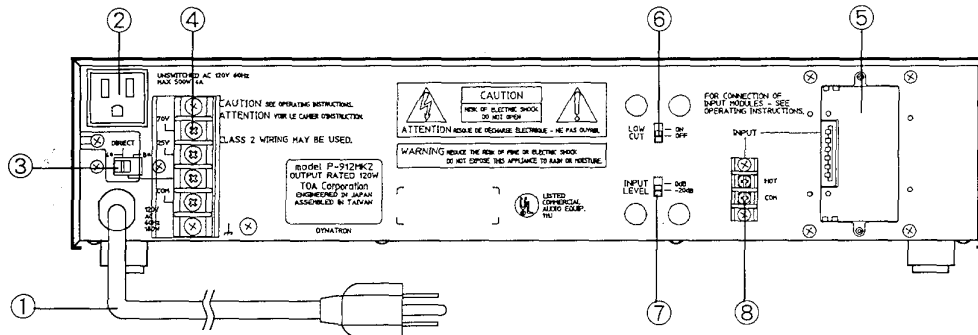

P-924MK2

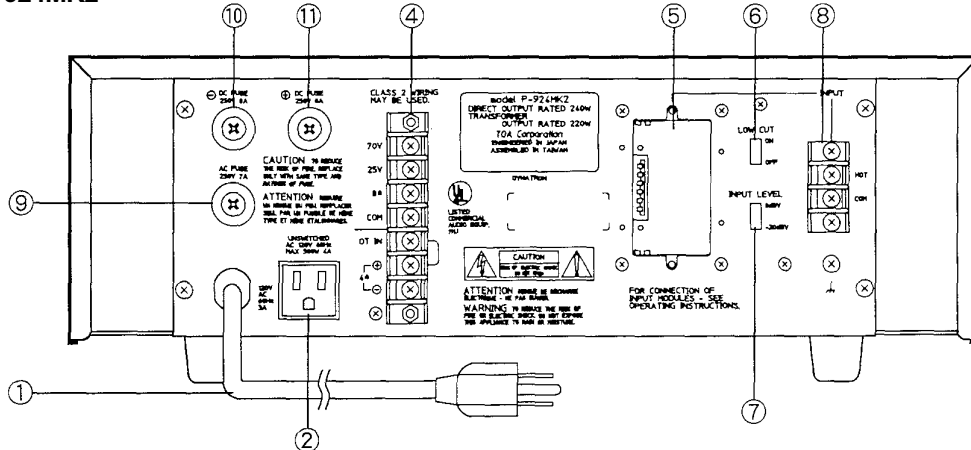

① AC Power Cord

Connects to power source.

② AC Outlet (Unswitched)

Provides AC power for auxiliary equipment with power consumption of up to 500W.

③ Impedance Select Switch

Selects the desired impedance.

Enables unbalanced output of low impedance when this switch is set to "DIRECT".

④ Output terminals

Connect to speakers.

⑤ Module Input Port

Accepts optional PLUG-IN MODULES.

Application determines type of module.

For details, refer to Plug-in Module Instruction Manual.

⑥ Low-Cut Switch

Cut off unnecessary low frequency.

⑦ Input Level Switch

Selects input sensitivity. Place in "1V" (0 dBV) position when normally used as a power amplifier.

Note: The position of INPUT-LEVEL SWITCH should be changed according to modules used or equipment connected to DIRECT INPUT TERMINAL.

⑧ Direct Input Terminal

Connects directly to external equipment without using modules.

Unbalanced 10k ohms.

⑨ AC Fuse (250V, 7A)

⑩ DC Fuse \ominus (250V, 8A)

⑪ DC Fuse \oplus (250V, 8A)

Protects amplifier from excessive current drain. Replace only with same type fuse.

Refer to qualified service personnel if fuse blows repeatedly.

■ Input Connections

- Two types of input terminals are provided on the rear for input connections.
 - (1) 2P terminal (marked HOT, COM)

It is provided for direct input (unbalanced, 10k ohms) without using plug-in module. This terminal is directly connected with a potentiometer inside.
 - (2) Plug-in module input

Select the desired module according to application.
DIRECT INPUT TERMINAL and MODULE INPUT are not usable simultaneously.
- Plug the modules into the INPUT PORT, sliding it between the guide rails and secure with two screws.
- When INPUT PORT is not occupied, cover the PORT with the blank panel and secure it with screws.
- Be sure that INPUT-LEVEL SWITCH is in the proper position for the module used or the equipment connected to DIRECT INPUT TERMINAL.
- When the P-906MK2, P-912MK2 or P-924MK2 is used in combination with a mixer preamplifier or serves as an incremental power amplifier, normally place INPUT-LEVEL SWITCH in "1V (0 dBV) position.

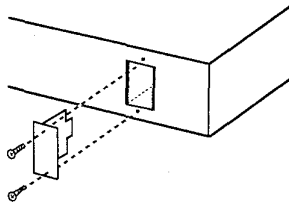

CAUTION: Modules should not be inserted or removed while the amplifier is turned on.

Output Connections

The speaker outputs of the amplifier are 4 ohms, 8 ohms, 25V and 70V.

Connect speakers to any one of these outputs.

Class 2 wiring may be used.

There are two types of output ;

- 8 ohms, 25V and 70V via output (matching) transformer
- 4-ohm direct output.

The connecting method differs in each case. Refer to the following diagrams.

Note : Impedances indicated below imply total speaker system (load) impedances.

● To connect speakers to outputs of : 8 ohms, 25V or 70V (BALANCED OUTPUT)

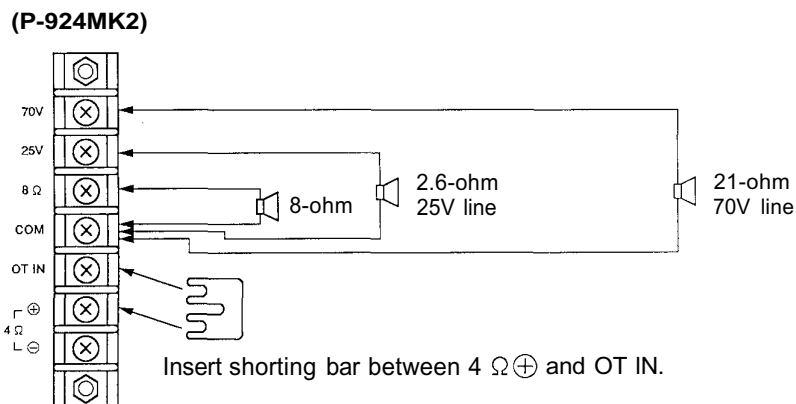
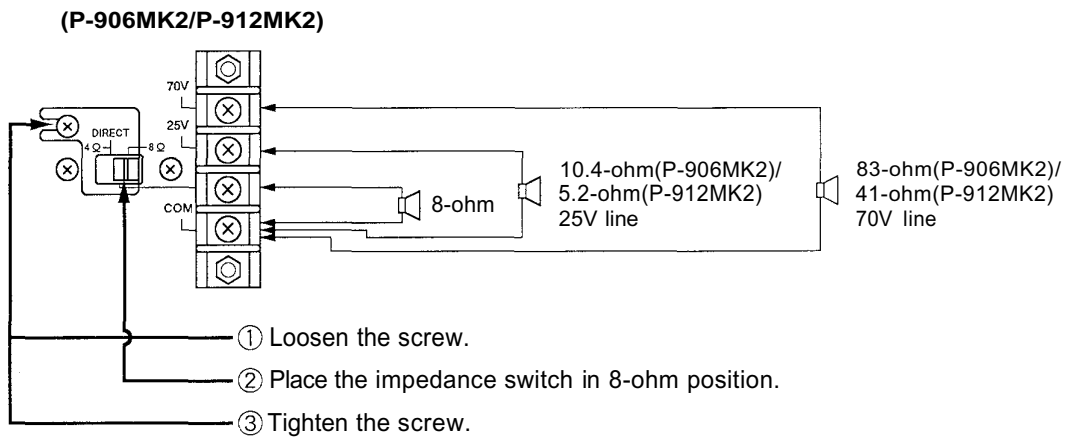

Note : Low-cut switch should be in "CUT" position.

Cut off unnecessary low frequency in TRANS OUTPUT to obtain best acoustic condition. The 900MK2 series amplifiers are characteristically flat even in the low frequency range. Thus, in TRANS OUTPUT the acoustic effect and frequency-response characteristics may be altered.

● To connect speakers to 4-ohm output (UNBALANCED DIRECT OUTPUT)

(P-906MK2/P-912MK2)

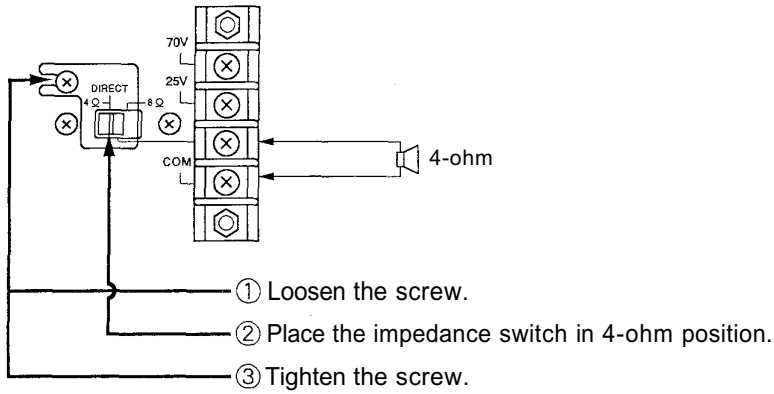

(P-924MK2)

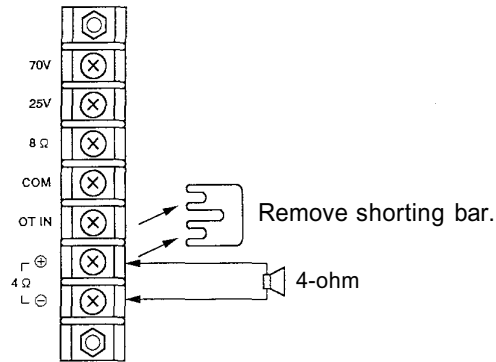

■ Rack Mounting

To mount the amplifier in a standard 19" equipment rack, use the optional MB-25B, MB-35B rack mounting bracket.

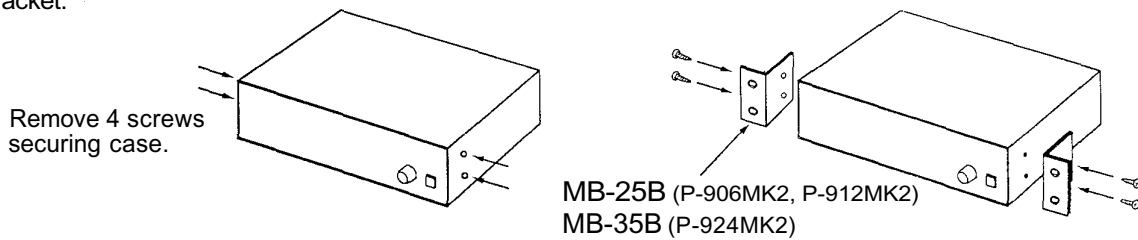

Fix the brackets with attached 4 screws. The length of screws should not exceed 12mm (1/2").

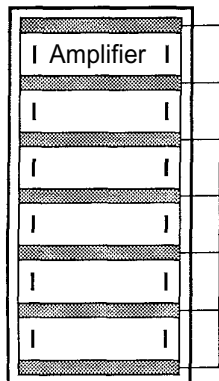

PF-511 perforated panel (1-unit size)

Use the perforated panel PF-511 to provide space for ventilation, when two or more units are mounted in an equipment rack. Contact your local TOA dealer for the perforated panel PF-511.

■ Operation

After all connections are made, turn power switch ON, illuminating the Power Indicator LED. The amplifier comes into operation approximately 5 seconds after the power is turned on.

■ Volume Adjustment

Obtain desired output level by adjusting the master volume control. For normal music playing or announcement, adjust the master volume control until the normal LED intermittently lights. Sound quality is deteriorated when the peak LED remains lit.

When the power amplifier is used in combination with a mixer preamplifier, adjust total gain at the mixer preamplifier with the gain setting of power amplifier at maximum.

■ Installation

Never block ventilation holes.

The amplifier should never be placed in areas

- exposed to direct sunlight.
- with high humidity or dust levels.
- with high ambient temperatures.
- susceptible to vibration.
- with poor ventilation.
- adjacent to heat-generating equipment.

CAUTION : Do not remove the case or you may encounter an electric shock.

Note : When the temperature of heat sink exceeds 105 °C the protection circuit is activated and the output is disconnected from the circuit. Output is automatically restored when the temperature return to normal operating parameter.

■ Servicing

● Unpacking

Upon receipt of the amplifier shipment, please inspect for any damage incurred in transit. If damage is found, please notify your local TOA representative and the transportation company immediately.

State date, nature of damage, whether any damage was noticed on the shipping container, prior to unpacking. Please give waybill number of shipping order.

● Failure

Should amplifier fail, contact your nearest TOA authorized contractor or service center.

■ Specifications

	P-906MK2	P-912MK2	P-924MK2
Type	Power amplifier		
Output Power	60W RMS	120W RMS	(D) 240W RMS, (T) 220W RMS
Power Band Width	(D) 20 ~20,000 Hz, 0.5% THD (T) 50 ~20,000 Hz, 0.5% THD		
Frequency Response	(D) 20 ~20,000 Hz, ± 1 dB (T) 20 ~15,000 Hz, ± 1 dB, (T) 20 ~20,000 Hz, +1 dB, -3 dB		
Total Harmonic Distortion	0.01% at 1 kHz, rated output		
Inputs	One Input Ports : Port accepts any input module except T-01. One Direct Input Note : Use of direct input prohibits use of modular input port.		
Input Sensitivity/Impedance	Input Port : 100 mV or 1000 mV (switchable)/10k ohms Direct Input : 100 mV or 1000 mV (switchable)/10k ohms		
Outputs (T)=Transformer (D)=Direct	Main (T) : 8 ohms, 25 & 70 volts, balanced Main (D) : 4 ohms, unbalanced		
Output Regulation (1 kHz)	(D) Less than 0.5 dB, no load to full load (T) Less than 1.0 dB, no load to full load		
Signal to Noise Ratio (Band Pass 20 -20,000 Hz)	Input level switch in 0 dBV (1000 mV) position : 108 dB Input level switch in -20 dBV (100 mV) position : 90 dB		
Controls	1 Input gain control 1 Input level switch 1 Power ON/OFF switch 1 Low-Cut switch		
Indicators	1 Power LED, 1 Protect LED, 1 Signal LED, 1 Normal LED, 1 Peak LED		
Protection	Self-protection, with AC fuse (inside)		Self-protection, with 2AC fuses (1 inside) and 2DC fuses
Connectors	Input Card-edge connector and screw-terminal strip Output Screw-terminal strip AC outlet 3-pin grounding type AC power cord/plug ... SJT, 3-prong type		
Power Consumption	100W	180W	120V/3A
Temperature Range	-10°C~+60°C [12°F~140°F]		
Dimensions (W) x (H) x (D)	420 x 99.1 x 358 mm [16.5 x 3.9 x 14.1 in.]		420 x 151.3 x 334.2 mm [16.5 x 6.0 x 13.2 in.]
Weight	9.1 kg [20.1 lb.]	10.9kg [24.0 lb.]	19.5kg [43 lb.]
Color	Black		
Standard Accessories	1 Volume control cover (YA-920)		
Other Features	Output disconnected for approx. 5 seconds after switching power on.		

* Specifications are subject to change without notice.

Appearance (P-906MK2/P-912MK2)

< Front View >

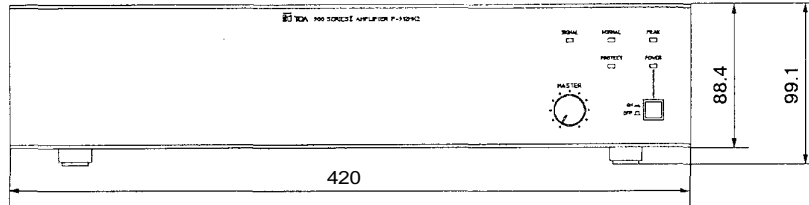

< Rear View >

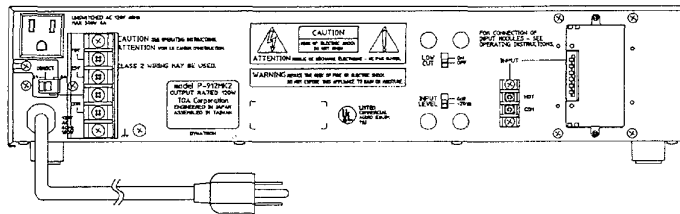

< Top View >

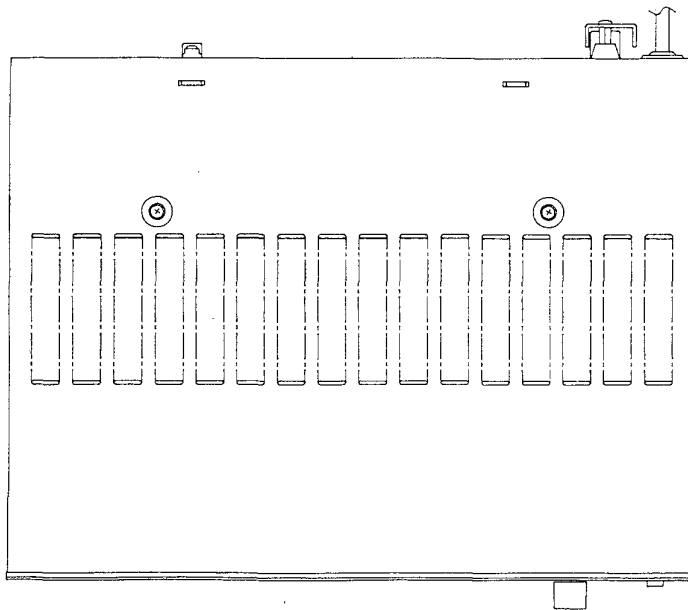

< Side View >

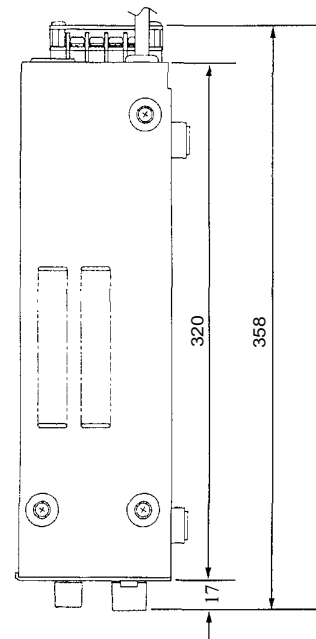

■ Appearance (P-924MK2)

< Front View >

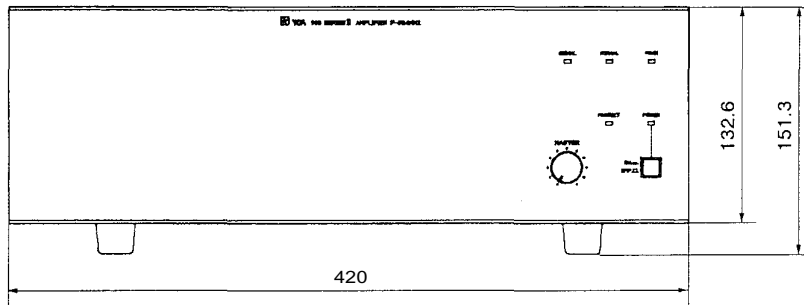

< Rear View >

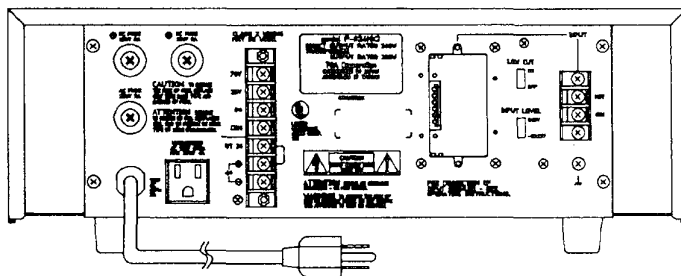

< Top View >

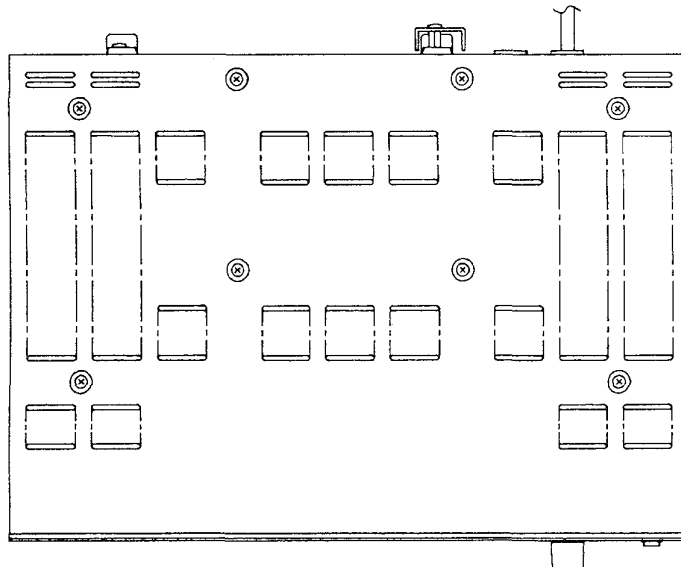

< Side View >

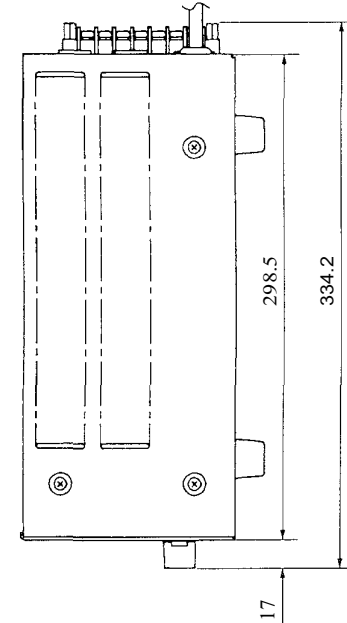



TOA Corporation
KOBE, JAPAN

PRINTED IN TAIWAN
133-12-116-60