

**WARRANTY
REGISTRATION:**
register online today for a
chance to win a FREE Tripp Lite
product—www.tripplite.com/warranty



Owner's Manual

Tripp Lite Utility/ Work Truck DC-to-AC Inverters



POWER BOOSTER!
Includes built-in charger for optional overnight recharging
of vehicle battery from shore power!

1111 W. 35th Street, Chicago, IL 60609 USA
Customer Support: (773) 869-1234
www.tripplite.com

Quiet, Economical Mobile Power...

Congratulations! You've purchased one of the most advanced, feature-rich Inverters designed for utility/work truck applications. Tripp Lite Utility/Work Truck Inverters provide quiet, convenient mobile power for every application: computers, TVs, electronic test equipment, power tools, pumps, compressors, blowers, lights, power supplies, radios, cell phone chargers and more. Since Tripp Lite Inverters draw power directly from vehicle batteries, they are the quiet, economical power alternative in residential environments or late-night job sites—without the noise, fumes, capital outlays, maintenance costs and occasional power overkill of generators! For generator-equipped trucks, they provide crews with the option of silent power.*

...With Optional Power-Boosting Functionality

In today's cost-cutting climate, fleet managers must get the most out of every vehicle—keeping trucks in the field longer, operating an ever-growing array of power tools. Standard vehicle alternators and batteries, however, often can't keep up with the increased power demand. When alternators recharge batteries at a slower rate than they are discharged, that leaves a power deficit for the next day's jobs and dramatically shortens battery service life. Tripp Lite Utility/Work Truck Inverters, with the addition of a built-in battery charger, help to overcome this power deficit. When optionally connected to shore power at the end of the day, Tripp Lite Utility/Work Truck Inverters quickly and safely recharge vehicle batteries, ensuring that maximum power is available for the next day's service schedule.** In addition, Tripp Lite Utility/Work Truck Inverters out-muscle other inverters on the market with peak power—handling tough loads like motors, compressors and incandescent lamps with ease.

Rugged Reliability Stands Up to Demanding Service Fleet Applications

- Powers everything from lights and power tools to sensitive testing equipment with frequency-controlled output
- Operates under the most severe conditions with heavy-duty, weather-resistant construction which meets tough marine standards for shock, vibration and moisture resistance***
- Enhances crew safety in moist environments with dual GFCI outlets (on select models)
- Delivers more AC power from your truck's system with high-efficiency DC-to-AC inversion
- Saves precious vehicle space with compact cabinet size

Battery Charger (Built-In) Provides Optional Overnight Charging

- Boosts battery to full charge for next day's jobs (on a routine or "as-needed" basis)
- Extends battery service life with safe, 3-stage charging and battery temperature-sensing function (featured on select models)

Remote Module (Included) Enables Convenient Control and Monitoring From Vehicle Cab

- Monitor battery voltage level and Inverter operating status
- Activate or deactivate Inverter with ease

Contents

Safety/Warranty/Warranty Registration	2	Mounting	8
Feature Identification	3	Battery Connection	9
Operation	3-4	AC Input/Output Connection	10
Configuration	5-6	Service/Maintenance	11
Battery Selection	7	Troubleshooting	11

* See "Utilize Automatic Generator Starter Capability" in the Configuration section for details. ** Depending on power needs, users may wish to complement a Tripp Lite Utility/Work Truck Inverter with a larger vehicle alternator and one or more auxiliary batteries. *** Tripp Lite Utility/Work Truck Inverters are moisture-resistant, not waterproof. Copyright © 2006 Tripp Lite.

Important Safety Instructions



SAVE THESE INSTRUCTIONS!

This manual contains important instructions and warnings that should be followed during the installation, operation and storage of all Tripp Lite Inverters.

Location Warnings

- The Inverter must be located in an enclosed compartment, shielded from outside weather conditions.
- Although your Inverter is moisture resistant, it is NOT water-proof. Flooding the unit with water will cause it to short circuit and could cause personal injury due to electric shock. Never immerse the unit, and avoid any area where standing water might accumulate. Mounting should be in the driest location available.
- Leave a minimum of 2" clearance at front and back of the Inverter for proper ventilation. To avoid automatic Inverter shutdown due to overtemperature, any compartment that contains the Inverter must be properly ventilated with adequate outside air flow. The heavier the load of connected equipment, the more heat will be generated by the unit.
- Do not install the Inverter directly near magnetic storage media, as this may result in data corruption.
- Do not install near flammable materials, fuel, chemicals or gasses

Battery Connection Warnings

- The Inverter will not operate (with or without utility power) until batteries are connected.
- Multiple battery systems must be comprised of batteries of identical voltage, age, amp-hour capacity and type.
- Because explosive hydrogen gas can accumulate near batteries if they are not kept well ventilated, your batteries should not be installed in a "dead air" compartment. Ideally, any compartment would have some ventilation to outside air.
- Sparks may result during final battery connection. Always observe proper polarity as batteries are connected.
- Do not allow objects to contact the two DC input terminals. Do not short or bridge these terminals together. Serious personal injury or property damage could result.

Equipment Connection Warnings

Do not use a Tripp Lite Inverter in life support or healthcare applications where a malfunction or failure of a Tripp Lite Inverter could cause failure of, or significantly alter the performance of, a life support device or medical equipment.

- You may experience uneven performance results if you connect a surge suppressor, line conditioner or UPS system to the output of the Inverter.
- Corded Models: Do not modify the Inverter's plug or receptacle in a way that eliminates its ground connection. Do not use power adapters that will eliminate the plug's ground connection.
- Connect your Inverter only to a properly grounded AC power outlet or hardwired source. Do not plug the unit into itself; this will damage the device and void your warranty.

Operation Warnings

- Your Inverter does not require routine maintenance. Do not open the device for any reason. There are no user serviceable parts inside.
- Potentially lethal voltages exist within the Inverter as long as the battery supply and/or AC input are connected. During any service work, the battery supply and AC input connection (if any) should therefore be disconnected.
- Do not connect or disconnect batteries while the Inverter is operating in either inverting or charging mode. Dangerous arcing may result. Operating Mode Switch should be in the OFF position.

Limited Warranty

Tripp Lite warrants its Inverters to be free from defects in materials and workmanship for a 30 month period from the date of retail purchase by end user.

Tripp Lite's obligation under this warranty is limited to repairing or replacing (at its sole option) any such defective products. To obtain service under this warranty you must obtain a Returned Material Authorization (RMA) number from Tripp Lite or an authorized Tripp Lite service center. Products must be returned to Tripp Lite or an authorized Tripp Lite service center with transportation charges prepaid and must be accompanied by a brief description of the problem encountered and proof of date and place of purchase. This warranty does not apply to equipment which has been damaged by accident, negligence or misapplication or has been altered or modified in any way, including opening of the unit's casing for any reason. This warranty applies only to the original purchaser who must have properly registered the product within 10 days of retail purchase.

EXCEPT AS PROVIDED HEREIN, TRIPP LITE MAKES NO WARRANTIES, EXPRESS OR IMPLIED, INCLUDING WARRANTIES OF MERCHANTABILITY AND FITNESS FOR A PARTICULAR PURPOSE. Some states do not permit limitation or exclusion of implied warranties; therefore, the aforesaid limitation(s) or exclusion(s) may not apply to the purchaser.

EXCEPT AS PROVIDED ABOVE, IN NO EVENT WILL TRIPP LITE BE LIABLE FOR DIRECT, INDIRECT, SPECIAL, INCIDENTAL OR CONSEQUENTIAL DAMAGES ARISING OUT OF THE USE OF THIS PRODUCT, EVEN IF ADVISED OF THE POSSIBILITY OF SUCH DAMAGE. Specifically, Tripp Lite is not liable for any costs, such as lost profits or revenue, loss of equipment, loss of use of equipment, loss of software, loss of data, costs of substitutes, claims by third parties, or otherwise.

Tripp Lite has a policy of continuous improvement. Specifications are subject to change without notice.

WARRANTY REGISTRATION

Visit www.tripplite.com/warranty to register the warranty of your new Tripp Lite product. You'll be automatically entered into a drawing for a chance to win a FREE Tripp Lite product!*

* No purchase necessary. Void where prohibited. Some restrictions apply. See website for details.

Feature Identification

Identify the premium features on your specific model and quickly locate instructions on how to maximize their use.

- 1 Configuration DIP Switches:** optimize Inverter operation depending on your application. See Configuration section for setting instructions.
- 2 Operating Mode Switch:** controls Inverter operation. See Operation section for setting instructions.
- 3 "LINE", "INVERT", "LOAD" LEDs:** intuitive "traffic light" signals show Inverter operation. They also warn you if the connected equipment load is too high. See Operation section for instructions on reading the indicator lights.
- 4 "BATT VOLT" or "BATT VOLT/CHRG CURR" LEDs:** on all models, these three lights will turn on in several sequences to indicate the approximate charge level of connected batteries. On 2012 and 3012 models, these lights indicate the approximate charge rate of the Inverter when the Operating Mode Switch is in the "CHARGE ONLY" position. See Operation section for instructions on reading indicator lights.
- 5 DC Power Terminals:** connect to your battery terminals. See Battery Connection section for instructions.
- 6 Ground Fault Interrupter (GFI) AC Receptacles (not on hardwire model):** allow you to connect equipment that would normally be plugged into a utility outlet. Enhancing safety, they feature ground fault interrupter switches that trip if there is excessive current on the ground safety wire.
- 7 AC Input Cord (not on hardwire model):** connects the Inverter to any source of utility- or generator-supplied AC power. See AC Input/Output Connection section for instructions.
- 8 Resettable Circuit Breakers:** protect your Inverter against damage due to overload. See Operation section for resetting instructions.
- 9 Remote Control Module Connector:** allows remote monitoring and control with an optional module included. See remote module owner's manual for connection instructions.
- 10 Main Ground Lug (front or rear mounted, depending on model):** properly grounds the Inverter to vehicle grounding system or to earth ground. See Configuration section for instructions.
- 11 Multi-Speed Cooling Fan:** quiet, efficient fan prolongs equipment service life.
- 12 Battery Temperature Sensing Connector (select models only):** prolongs battery life by adjusting charge based on battery temperature. Use with cable (included). See Configuration section for details.
- 13 "AUTO GEN START" Connector (select models only):** this automatic generator start feature is not typically applicable in utility/work truck applications. However, for generator-equipped trucks, it provides crews with the option of quiet power. See "Utilize Automatic Generator Starter Capability" in the Configuration section for details.
- 14 Hardwire AC Input/Output Terminals (not on corded models):** securely connect the Inverter to vehicle electrical system input and recommended GFCI receptacle output. See AC Input/Output Connection.
- 15 DC Power Terminal Cover Plate**
- 16 Hardwire AC Input/Output Cover Plate**

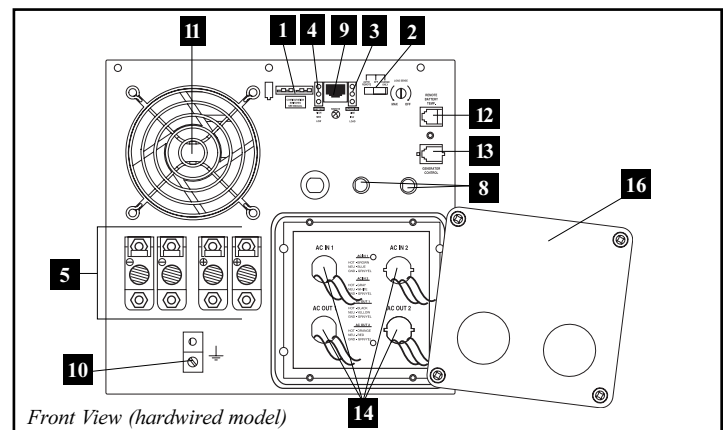
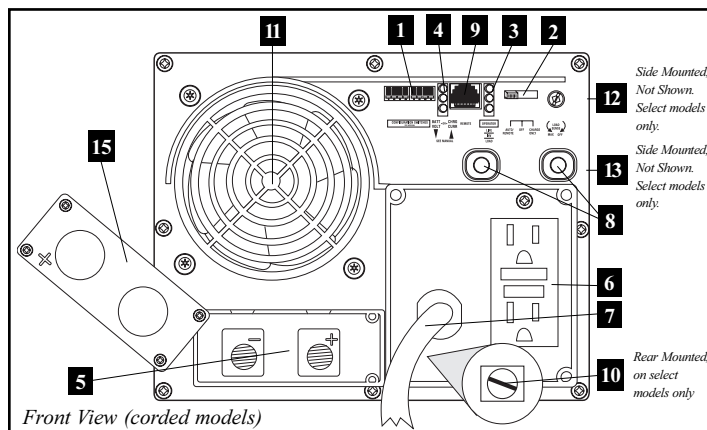

Operation

Switch Modes

After configuring, mounting and connecting your Inverter, you can operate it by switching between the following operating modes as appropriate to your situation:

AUTO/REMOTE: Switch to this mode during normal operational conditions. When service vehicles are deployed, the Inverter will draw from connected batteries to supply AC power to connected equipment. This mode also enables the optional remote control module (included) to function when connected to the unit. It is fine to leave the switch in this mode at the end of the day (when service vehicles are parked) especially when relying upon the remote control as your main control. Note: when connected to shore power, AC power is not only routed to the battery charger but passes through to the GFCI outlets or hardwire terminals (depending on model) as well.

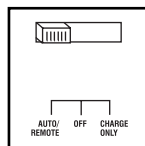

OFF: Switch to this mode during normal operational conditions if you want to completely shut down the unit's inverter, cut-off the remote control module's functionality and shut off power to the AC outlets or hardwire terminals. For extended periods of "dry dock" time, switch to this mode if the Inverter is not plugged into shore power.

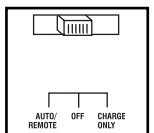

CHARGE ONLY: Switch to this mode when service vehicles are parked and (optionally) connected to shore power for extended periods of "dry dock" time, as with seasonal-use trucks. This mode will enable the unit's charger, but will disable the unit's inverter. Note: when connected to shore power, AC power is not only routed to the battery charger but passes through to the GFCI outlets or hardwire terminals (depending on model) as well.

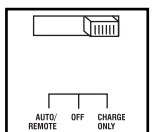

Operation section continued on next page.

Indicator Lights

Your Inverter (as well as an optional Tripp Lite Remote Control Module) is equipped with a simple, intuitive, user-friendly set of indicator lights. These easily-remembered “traffic light” signals will allow you, shortly after first use, to tell at a glance a wide variety of operating details.

“LINE Green LED”: If the operating mode switch is set to “AUTO/REMOTE”, this light will ILLUMINATE CONTINUOUSLY when your vehicle is connected to shore (or generator) power.

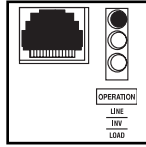

If the operating mode switch is set to “CHARGE ONLY”, this light will BLINK to alert you that the unit’s inverter is OFF and will NOT supply AC power in the absence of a utility/generator source.

“INV” (Inverting) Yellow LED: This light will ILLUMINATE CONTINUOUSLY whenever connected equipment is receiving battery-supplied, inverted AC power.

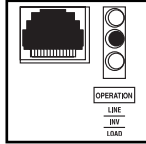

“LOAD” Red LED: This red light will ILLUMINATE CONTINUOUSLY whenever the inverter is functioning and the power demanded by connected equipment exceeds 100% of load capacity. The light will BLINK to alert you when the inverter shuts down due to a severe overload or overheating. If this happens, turn the operating mode switch “OFF”; remove the overload and let the unit cool. You may then turn the operating mode switch to either “AUTO/REMOTE” or “CHARGE ONLY” after it has adequately cooled.

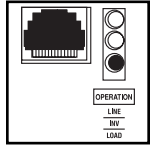

“BATT VOLT” or “BATT VOLT/CHRG CURR” LEDs: Depending on your model, this set of three LEDs will display different operating information.

750 and 1250 models: Whether the switch is in the “AUTO/REMOTE” or “CHARGE ONLY” position, the LEDs indicate the approximate charge level and voltage of your connected battery bank and alert you to several fault conditions. See “BATT VOLT” LED Function Chart for details.

2012 and 3012 models only: If the switch is in the “AUTO/REMOTE” position, the LEDs indicate the approximate charge level and voltage of your connected battery bank and alert you to several fault conditions. See “BATT VOLT” LED Function Chart for details.

If the switch is in the “CHARGE ONLY” position, the LEDs indicate the approximate charge rate of the Inverter. See “CHRG CURR” LED Function Chart for details. Note: the charge rates in the chart are expressed as percentages of the Inverter's rated charging amps. Refer to the specifications to determine the charging amps of your specific model.

“BATT VOLT” LED Function Chart (All models)

Approximate Battery Charge Level*

LEDs Illuminated	Battery Capacity (Charging/Discharging)
1 Green	91%–Full
2 Green & Yellow	81%–90%
3 Yellow	61%–80%
4 Yellow & Red	41%–60%
5 Red	21%–40%
6 All three lights off	1%–20%
7 Flashing red	0% (Inverter shutdown)**

* Charge levels listed are approximate. Actual conditions vary depending on battery condition and load. ** Inverter shutdown protects battery against damage due to excessive discharge.

Fault Condition

LEDs Illuminated	Fault Condition
1 All three lights flash slowly*	Excessive discharge (Inverter shutdown)
2 All three lights flash quickly**	Overcharge (Charger shutdown)

*Approximately 1/2 second on, 1/2 second off. See Troubleshooting section. Inverter shutdown protects battery against damage due to excessive discharge. ** Approximately 1/4 second on, 1/4 second off. Charger shutdown protects battery against damage due to overcharge. May also indicate a battery charger fault exists. See Troubleshooting section.

“CHRG CURR” LED Function Chart (2012 and 3012 models only)

Approximate Charge Rate Indication

LEDs Illuminated	Charge Rate
1 All three lights on	Overcharge error*
2 Red	75% - 100%
3 Red & Yellow	50% - 75%
4 Yellow	25% - 50%
5 Green	0% - 25%
6 All three lights off	0%

* If all three lights remain on, an internal fault may exist. Turn off and disconnect the unit. Then, call Tripp Lite at (773) 869-1234 for assistance.

Resetting Your Inverter to Restore AC Power

Your Inverter may cease supplying AC power or DC charging power in order to protect itself from overload or to protect your electrical system. To restore normal functioning:

Overload Reset: Switch operating mode switch to “OFF” and remove some of the connected electrical load (ie: turn off some of the AC devices drawing power which may have caused the overload of the unit). Wait one minute, then switch operating mode switch back to either “AUTO/REMOTE” or “CHARGE ONLY.”

Output Circuit Breaker Reset: Alternatively, check output circuit breaker(s) on the unit's front panel. If tripped, remove some of the electrical load, then wait one minute to allow components to cool before resetting the circuit breaker. See Troubleshooting for other possible reasons AC output may be absent.

Configuration

Note: Tripp Lite recommends that users only change settings for the DIP switches and controls described below. Additional DIP switches and controls located in the unit's DIP switch panel or in other areas are preset to optimize the unit's operation. Setting these DIP switches or controls may adversely affect the unit's operation.

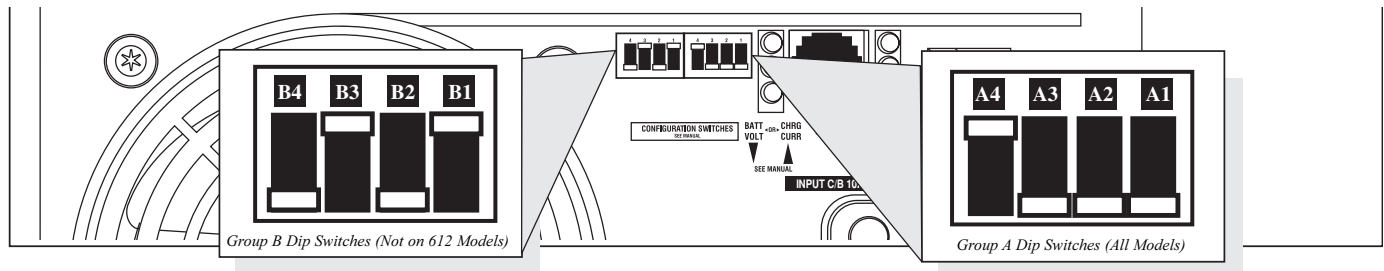

Group A DIP Switches (All Models)

Using a small tool, configure your Inverter/Charger by setting the four Group A DIP Switches (located on the front panel of your unit; see diagram) as follows:

A1 Select Battery Type—REQUIRED (All models)

CAUTION: The Battery Type DIP Switch setting must match the type of batteries you connect, or your batteries may be degraded or damaged over an extended period of time. See "Battery Selection," p. 6 for more information.

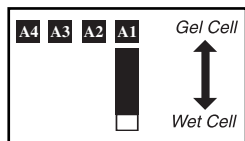

Battery Type	Switch Position
Gel Cell (Sealed) Battery	Up
Wet Cell (Vented) Battery	Down (factory setting)

A2 Select Charger Enable/Inhibit (750 and 1250 models only)

Switch is present to ENABLE, which permits continuous battery charging. If you are connecting your unit to batteries with a separate charger, you may set this switch to INHIBIT to disable its built-in charger to prevent overcharging.

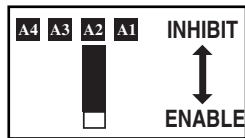

Charger Status	Switch Position
Inhibit	Up
Enable	Down (factory setting)

Select High AC Input Voltage Point for Switching to Battery—OPTIONAL (2012 model only)

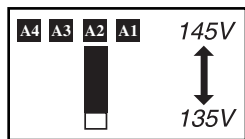

Voltage	Switch Position
145V	Up
135V	Down (factory setting)

A4 A3 Select Low AC Input Voltage Point for Switching to Battery—OPTIONAL*

Voltage	Switch Position
105V	#A4 Up & #A3 Up
95V	#A4 Up & #A3 Down
85V	#A4 Down & #A3 Up
75V	#A4 Down & #A3 Down (factory setting)

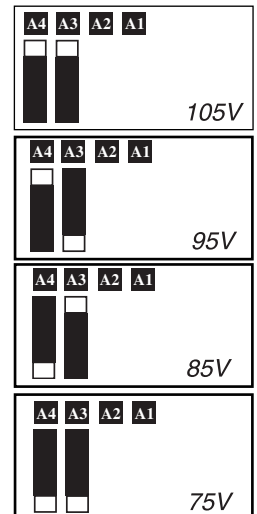

* Most of your connected appliances and equipment will perform adequately when your Inverter/Charger's Low AC Input Voltage Point (DIP Switch #3 and #4 of Group A) are set to 95V. However, if the unit frequently switches to battery power due to momentary low line voltage swings that would have little effect on equipment operation, you may wish to adjust this setting. By decreasing the Low AC Voltage Point, you will reduce the number of times your unit switches to battery due to voltage swings.

Group B DIP Switches

B2 B1 Battery Charger Limiting

Your Inverter/Charger features a high-output battery charger that can draw a significant amount of AC power from your utility source or generator when charging at its maximum rate. If the unit is simultaneously supplying its full AC power rating to connected heavy electrical loads and charging at its maximum rate, the AC input circuit breaker could trip, resulting in a complete shutoff of pass-through utility power.

To reduce the possibility of tripping this breaker, your Inverter/Charger may be set to limit charger output automatically. This keeps the sum of the unit's AC load and charge power within the circuit breaker's rating. The charger-limiting function has two settings, enabling you to reduce charger draw as needed to prevent the AC input circuit breaker from tripping. The figures below show how to set your unit's DIP Switches to enable battery charger limiting.

Set Battery Charger Limiting—OPTIONAL

“Most Limiting” (#B2 & #B1 Up): Charger-limiting takes effect the moment any 120V AC load is applied; charger output falls gradually from full output at no 120V load passing through to no output at full load (factory setting).

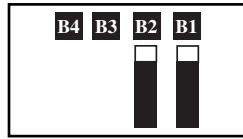

Note: UT1250UL models may only be set to “Most Limiting.”

“Less Limiting” Charger-limiting begins when the Inverter/Charger's load reaches 33% of the Inverter/Charger's load rating. Charger output falls gradually from full output at 33% of the Inverter/Charger's load rating to about 40% of full output at full load.

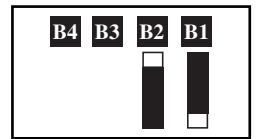

Connect Remote Control—OPTIONAL

An 8-conductor telephone style receptacle on the front panel is included for use with an optional remote control module (included). The remote module allows the Inverter to be mounted in a compartment or cabinet out of sight, while operated conveniently from within the cab of your vehicle. See instructions packed with the remote control module.

Connect Battery Temperature Sensing Cable—OPTIONAL—(Select models only)

The battery temperature sensing function prolongs battery life by adjusting the charge float voltage level based on battery temperature. Connect the sensor cable (the cable, included, has an RJ style connector on one end and a black sensor on the other) to the RJ style jack located on the side of the Inverter labeled “Remote Temp. Sense.” With user-supplied electrical or duct tape, affix the sensor to the side of the battery below the electrolyte level. Make sure that nothing, not even tape, comes between the sensor and the side of the battery. To guard against false readings due to ambient temperature, place the sensor between batteries, if possible, or away from sources of extreme heat or cold. If the sensor cable is not used, the Inverter will charge according to its default 25° C values.

Utilize Automatic Generator Starter Capability—OPTIONAL—(Select models only)

Although not typically applicable to utility/work truck situations, select Inverter models offer an RJ type modular jack on the side panel labeled “Generator Start.” If your current fleet is already equipped with generators, select Tripp Lite Utility/Work Truck Inverters provide your crews the option of quiet power for residential environments or late-night job sites. When wattage loads are within the Inverter's ratings, crews can avoid the power overkill, fuel consumption, fumes and noise of generator use.

To tie the Inverter and generator together, simply connect the generator's AC power output to the Inverter's AC input. The Inverter will automatically charge the battery when generator power is available, and generator power will automatically pass-through for use via the Inverter's GFCI receptacles or hardwire terminals (depending on model). To automatically activate the generator when battery voltage runs low, attach to vehicle generator ON/OFF switching mechanism with user-supplied cable (see Pin Configuration Diagram). Once attached, the interface will allow the Inverter to automatically switch a vehicle generator on when connected battery voltage levels are low (11.6 VDC) and switch it off when battery voltage levels are high (14.1 VDC).

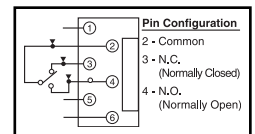

Battery Selection (optional)

To extend Inverter runtimes without upgrading your truck's alternator, you may wish to create an "intra-day" power reservoir by adding auxiliary batteries to your system, typically tied to the chassis battery via an isolator. Large intra-day power deficits, despite overnight charging, are an indicator that a larger alternator may be necessary. Although the Inverter can supply AC power without the vehicle engine running, the alternator of a running engine replaces lost DC voltage. Especially when operating heavier electrical loads, you may wish to "assist your batteries" by idling the vehicle engine, or during extra-heavy-duty use, by running the engine at faster-than-normal idling.

Select Auxiliary Battery Type (if any)

If you elect to add an auxiliary battery(ies), select "Deep Cycle" batteries to receive optimum performance from your Inverter. Although ordinary vehicle batteries rated in Cold Cranking Amps (CCA) are an acceptable source of 12V input, any auxiliary battery(ies) would ideally be true Deep Cycle batteries, lengthening the operational lifetimes of the auxiliary battery bank.

Batteries of either Wet-Cell (vented) or Gel-Cell / Absorbed Glass Mat (sealed) construction are ideal. 6-volt "golf cart", Marine Deep-Cycle or 8D Deep-Cycle batteries are also acceptable. You must set the Inverter's Battery Type DIP Switch (see Configuration section for more information) to match the type of batteries you connect or your batteries may be degraded or damaged over an extended period of time. In many cases, the vehicle battery may be the only one installed. Auxiliary batteries must have the same voltage as vehicle batteries if they are connected to each other.

Match Battery Amp-Hour Capacity to Your Application

Select a battery or system of batteries that will provide your Inverter with proper DC voltage and an adequate amp-hour capacity to power your application. Even though Tripp Lite Inverters are highly efficient at DC-to-AC inversion, their rated output capacities are limited by the total amp-hour capacity of connected batteries and the support of your vehicle's alternator if the engine is kept running.

Example

• STEP 1: Determine Total Wattage Required

Add the wattage ratings of all equipment you will connect to your Inverter. Wattage ratings are usually listed in equipment manuals or on nameplates. If your equipment is rated in amps, multiply that number times AC utility voltage to determine watts. (Example: a ¼ in. drill requires 2½ amps. 2½ amps × 120 volts = 300 watts .)

Note: Your Inverter will operate at higher efficiencies at about 75% - 80% of nameplate rating.

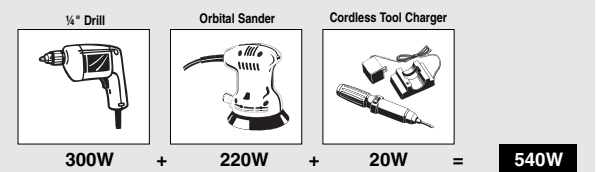

• STEP 2: Determine DC Battery Amps Required

Divide the total wattage required (from step 1, above) by the battery voltage (12) to determine the DC amps required.

$$540 \text{ watts} \div 12\text{V} = 45 \text{ DC Amps}$$

• STEP 3: Estimate Battery Amp-Hours Required

(for operation unsupported by the alternator)

Multiply the DC amps required (from step 2, above) by the number of hours you estimate you will operate your equipment without recharging the batteries by running the vehicle engine, or via shore or generator input to the Inverter's battery charger. Compensate for inefficiency by multiplying this number by 1.2. This will give you a rough estimate of how many amp-hours of battery power (from one or several batteries) you should connect to your Inverter.

NOTE! Battery amp-hour ratings are usually given for a 20-hour discharge rate. Actual amp-hour capacities are less when batteries are discharged at faster rates. For example, batteries discharged in 55 minutes provide only 50% of their listed amp-hour ratings, while batteries discharged in 9 minutes provide as little as 30% of their amp-hour ratings.

$$45 \text{ DC Amps} \times 5 \text{ Hrs. Runtime} \\ \times 1.2 \text{ Inefficiency Rating} = 270 \text{ Amp-Hours}$$

• STEP 4: Estimate Battery Recharge Required, Given Your Application

If your vehicle's alternator does not replace all battery voltage inverted to support your equipment, you must allow your batteries to recharge long enough to replace the charge lost during inverter operation to avoid eventual run-down of your batteries. To estimate the minimum amount of time you need to recharge your batteries given your application, divide your required battery amp-hours (from step 3, above) by your Inverter's rated charging amps.

$$270 \text{ Amp-Hours} \div 55 \text{ Amps} \\ \text{Inverter Rating} = 5 \text{ Hours Recharge}$$

Mounting



WARNING! Mount your Inverter BEFORE DC battery and AC power connection. Failure to follow these instructions may lead to personal injury and/or damage to the Inverter and connected systems.

Tripp Lite recommends permanent mounting of your Inverter. User must supply mounting hardware and is responsible for determining if the hardware and mounting surface are suitable to support the weight of the Inverter. Contact Tripp Lite if you require further assistance in mounting your Inverter.

Vehicular and Non-Vehicular Mounting

• Horizontal Mount • Vertical Mount

Whether mounted horizontally or vertically, the Inverter must be located in an enclosed compartment, shielded from outside weather conditions.

750 & 1250 models only

A Using the measurements from the diagram, install two user-supplied 1/4" (6 mm) fasteners into a rigid horizontal surface, leaving the heads slightly raised. **B** Slide the Inverter back over the fasteners to engage the mounting slots molded on the bottom of the Inverter cabinet. **C** Install and tighten two user-supplied 1/4" (6 mm) fasteners into the mounting feet molded on the front of the Inverter cabinet. The polycarbonate cabinet and mounting feet of your Utility/Work Truck Inverter are durable enough to allow for vertical mounting as well, if your vehicle compartment requires this configuration. For vertical mounting, the control panel of the Inverter should face up.

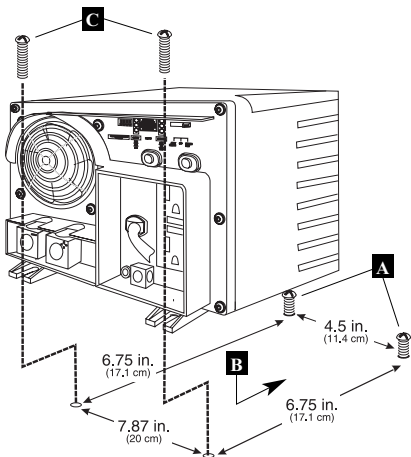

2012 model only

A Using the measurements from the diagram, install two user-supplied 1/4" (6 mm) fasteners into a rigid horizontal surface, leaving the heads slightly raised. **B** Slide the Inverter forward over the fasteners to engage the mounting feet molded on the front of the Inverter cabinet. Install and tighten additional user-supplied 1/4" (6 mm) fasteners into the mounting feet molded on the rear and sides of the Inverter cabinet. The rear feet extend beyond the unit's cabinet to provide for adequate ventilation space behind the cooling fan(s); they should not be removed. The polycarbonate cabinet and mounting feet of your Utility/Work Truck Inverter are durable enough to allow for vertical mounting as well, if your vehicle compartment requires this configuration. For vertical mounting, the control panel of the Inverter should face up.

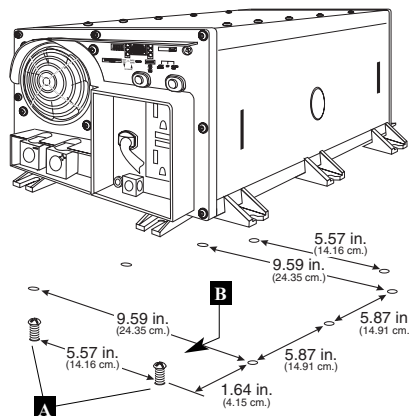

3012 model only

A Using the measurements from the diagram, install four user-supplied 1/4" (6 mm) fasteners into a rigid horizontal surface, leaving the heads slightly raised. **B** Slide the Inverter's keyhole mounting slots down over the raised fastener heads. Slide Inverter forward or backward to engage the slots and tighten fasteners. **C** For additional stability, install additional fasteners through the additional mounting slots provided on the Inverter.

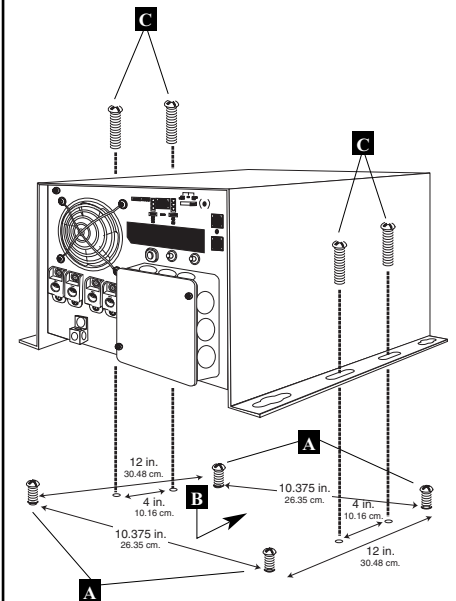

Battery Connection

Connect your Inverter to your batteries using the following procedures:

• **Connect DC Wiring:** Though your Inverter is a high-efficiency transformer of electricity, its rated output capacity is limited by the length and gauge of the cabling running from the battery to the unit. Use the shortest length and largest diameter cabling (maximum 2/0 gauge) to fit your Inverter's DC Input terminals. Shorter and heavier gauge cabling reduces DC voltage drop and allows for

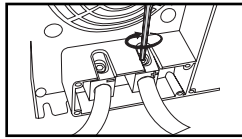

DC Connectors

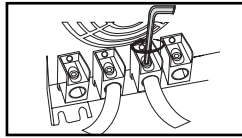

Dual DC Connectors
(See note at bottom of the page)

maximum transfer of current. Your Inverter is capable of delivering peak wattage at up to 200% of its rated continuous wattage output for brief periods of time. Heavier gauge cabling should be used when continuously operating heavy draw equipment under these conditions. Tighten your Inverter and battery terminals to approximately 3.5 Newton-meters of torque to create an efficient connection and to prevent excessive heating at this connection. Insufficient tightening of the terminals could void your warranty. See separate Specifications page for Minimum Recommended Cable Sizing Chart.

• **Connect Ground:** Using a #8 AWG wire or larger directly connect the Main Ground Lug to

the vehicle's chassis or earth ground. See the Feature Identification section to locate the Main Ground Lug on your specific Inverter model. All installations must comply with national and local codes and ordinances.

• **Connect Fuse:** NEC (National Electrical Code) article 551 requires that you connect all of your Inverter's positive DC Terminals directly to a UL-listed fuse(s) within 18 inches of the battery. The fuse's rating must equal or exceed the Minimum DC Fuse Rating listed in your Inverter's specifications. See Specifications for fuse recommendations. See diagrams below for proper fuse placement.



WARNING! • Failure to properly ground your Inverter to a vehicle's chassis or earth ground may result in a lethal electrical shock hazard.

- Never attempt to operate your Inverter by connecting it directly to output from an alternator rather than a battery or battery bank.
- Observe proper polarity with all DC connections.

Vehicular

Your Inverter's Nominal DC Input Voltage **must match** the voltage of your battery or batteries—12 Volts in most vehicular applications.

In most vehicles, the Inverter will be connected to the main battery within your vehicle's electrical system. However, it is also possible to connect your Inverter to one or more dedicated auxiliary (house) batteries which are isolated from the drive system to prevent possible draining of the main battery.

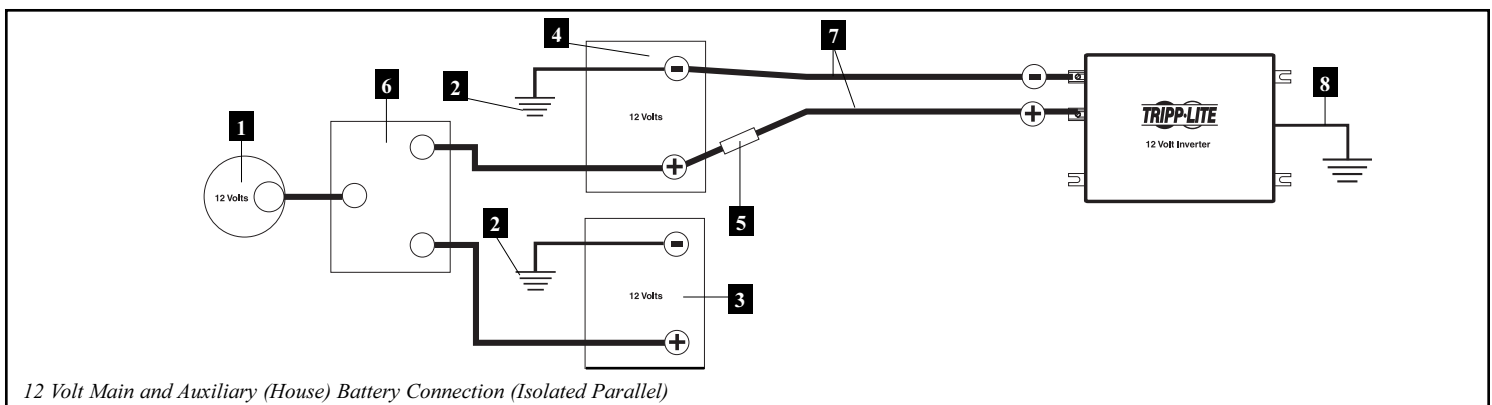
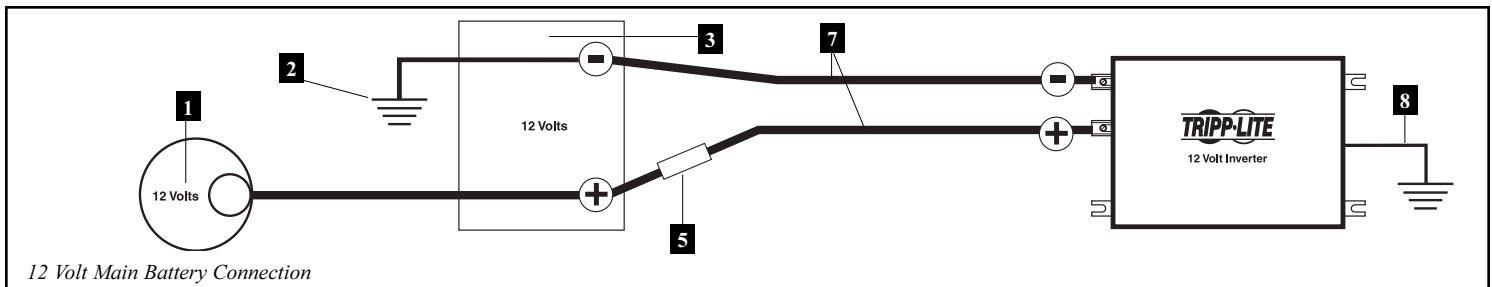

- 1 12 Volt Alternator 2 Vehicle Battery Ground 3 12 Volt Main Battery 4 12 Volt Auxiliary (House) Battery 5 UL-Listed Fuse (mounted within 18 inches of the battery) 6 Battery Isolator 7 Large Diameter Cabling, Maximum 2/0 Gauge to Fit Terminals 8 8 AWG (minimum) Ground Wire

NOTE: Select models include two positive and two negative DC terminals. Using the same connection architecture illustrated in the diagrams, run two 2/0 gauge cables from the Inverter's two negative terminals to the battery's single negative terminal; run two 2/0 gauge cables from the Inverter's two positive terminals, through two UL-listed fuses and fuse blocks, or equivalent, (one on each cable), to the battery's single positive terminal. Use the equivalent of two 2/0 cables in all other connections within the battery system. Connection to Two DC Terminals: It is acceptable to use two cables to connect your battery to only one positive and one negative DC terminal, however, your Inverter will provide reduced output power. It doesn't make a difference which positive and negative terminal you choose for the connection because both positive terminals are internally bonded and both negative terminals are also internally bonded. In this connection you must run one positive cable through one user-supplied UL-listed fuse and fuse block.

AC Input/Output Connection

To avoid overloading your Inverter, match the power requirements of the equipment you plan to run at any one time (add their total watts) with the output wattage capacity of your Inverter model. Do not confuse “continuous” wattage with “peak” wattage ratings. Most electric motors require extra power at start-up (“peak wattage”) than required to run continuously after start-up, sometimes over 100% more. Some motors, such as in pumps, start and stop intermittently according to demand, requiring “peak wattage” at multiple, unpredictable times during operation. DoubleBoost® Feature: Tripp Lite Inverters deliver up to twice their nameplate rated wattage for up to 10 seconds,* providing the extra power needed to cold start heavy-duty tools and equipment. OverPower™ Feature: Tripp Lite Inverters deliver up to 150% of their name-plate rated wattage for up to 1 hour,* providing plenty of reserve power to reliably support tools and equipment longer.

* Actual duration depends on model, battery age, battery charge level and ambient temperature.

Connection for Models with Cords and Receptacles

Plug the Inverter’s AC input cord into an extension cord and then into an outlet providing 120V AC, 60Hz. power. Make sure that the circuit you connect your Inverter to has adequate overload protection, such as a circuit breaker or a fuse. Plug your equipment into the Inverter’s AC receptacles.



WARNING! Consult a qualified electrician and follow all applicable electrical codes and requirements for hardwire connection. Disconnect both DC input and AC utility supply before attempting hardwiring.

Connection for Models with Hardwire Terminals

Output Connection Requirement: UL requires that the output terminals of all hardwire Inverter models must be connected to UL-listed GFCI receptacles (required receptacle manufacturer/model series: Leviton 6599).

Dual Input/Output Models

Select models provide higher bypass power capacity by enabling connection of two separate AC input sources. These two sources can be either two 120V legs split from a single 240V service (with opposite phase on each 120V leg) or two different 120V sources. The Inverter will only supply 120V output power and WILL NOT provide 240V output even if it is connected to inputs from a split 240V service when in inverter mode. When the Inverter is receiving AC power, it can supply connected loads with up to 20 amps of power on each circuit**. When the Inverter is not receiving AC power, and has switched to inverting DC battery power, it can supply connected loads with various amperage levels (see “Maximum Output AC Current” in Specifications section) on BOTH circuits. Dual input/output models provide for either: a) dual-source inputs and outputs; b) single-source input and output; or c) single-source input and dual-source outputs (with AC OUT 2 power only available in invert mode). Connect user-supplied wire and conduit to the connections as follows:

Input: Connect incoming wires to hot (black for AC IN 1, black for AC IN 2), neutral (white for AC IN 1, white for AC IN 2) and ground (green/yellow) wires.

Output: Connect outgoing wires to hot (black for AC OUT 1, black for AC OUT 2), neutral (white for AC OUT 1, white for AC OUT 2) and ground (green/yellow) wires.

Dual-Source Input/Output*

- AC IN 1 will only provide line power to AC OUT 1.
- AC IN 2 will only provide line power to AC OUT 2.
- Inverted battery power is supplied to both AC OUT 1 and AC OUT 2.

Single-Source Input/Output*

- If you only have a single 120V AC input source, you must connect it to AC IN 1.
- If you only have a single output circuit, you must connect it to AC OUT 1

* Single-Source or Dual-Source Input/Output Connection: As well as supplying power to connected loads, AC IN 1 also provides power to the battery charger. If you connect a large load to AC OUT 1, you should select a more limiting battery charger setting (see “Select Battery Charger-Limiting Points”) or you may experience continual nuisance tripping of the electrical service (source) circuit breaker which supplies AC IN 1. The Inverter will only measure the current at AC OUT 1 to automatically limit the charger rate. AC IN 2 input current is passed through to AC OUT 2 without measurement. Single-Source Input/Dual-Source Output Connection: You may connect AC IN 1 and AC IN 2 to a single source to provide power to AC OUT 1 and AC OUT 2. However, the loads connected to AC OUT 2 will not be measured for the purpose of automatic charger limitation. This could result in occasional tripping of the electrical service (source) circuit breaker. If this occurs, reduce the load on AC OUT 2 until nuisance tripping stops.

** Load circuit breaker limited

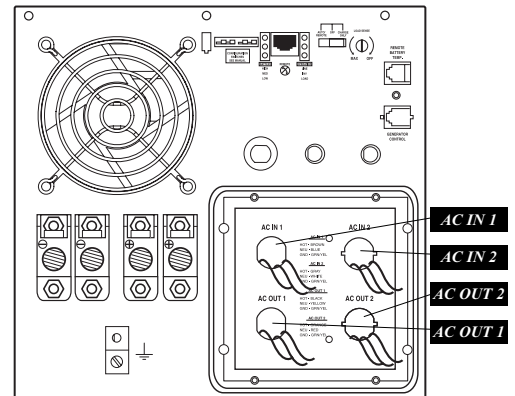

Service

Before returning your Inverter for service, follow these steps: 1.) Review the installation and operation instructions to ensure that the service problem does not originate from a misreading of the instructions. Also, check that the circuit breaker(s) are not tripped.* 2.) If the problem continues, do not contact or return the Inverter to the dealer. Instead, call Tripp Lite at (773) 869-1233. A service technician will ask for the Inverter's model number, serial number and purchase date and will attempt to correct the problem over the phone. 3.) If the problem requires service, the technician will issue you a Returned Material Authorization (RMA) number, which is required for service. Securely pack the Inverter to avoid damage during shipping. Do not use Styrofoam beads for packaging.** Any damages (direct, indirect, special, incidental or consequential) to the Inverter incurred during shipment to Tripp Lite or an authorized Tripp Lite service center is not covered under warranty. Inverters shipped to Tripp Lite or an authorized Tripp Lite service center must have transportation charges prepaid. Mark the RMA number on the outside of the package. If the Inverter is within the warranty period, enclose a copy of your sales receipt. Return the Inverter for service using an insured carrier to the address given to you by the Tripp Lite service technician.

* This is a common cause of service inquiries which can be easily remedied by following the resetting instructions in this manual. ** If you require packaging, the technician can arrange to send you proper packaging.

Maintenance

Your Inverter requires no maintenance and contains no user-serviceable or replaceable parts, but should be kept dry at all times. Periodically check, clean and tighten all cable connections, as necessary, both at the unit and at the battery.

Troubleshooting

Try these remedies for common Inverter problems before calling for assistance. Call Tripp Lite Customer Service at (773) 869-1234 before returning your unit for service.

SYMPTOM	PROBLEMS	CORRECTIONS
No AC Output (All Indicator Lights are OFF)	Operating Mode Switch is set to "OFF"	Set Operating Mode Switch to "AUTO/REMOTE" or "CHARGE ONLY".
	This is normal when the Operating Mode Switch is set to "CHARGE ONLY" and AC input is absent.	No correction is required. AC output will return when AC input returns. Set Operating Mode Switch to "AUTO/REMOTE" if you require AC output.
	Circuit breaker is tripped.	Reset circuit breaker.
	Unit has shut down due to battery overcharge (preventing battery damage). The problem may be with connected auxiliary chargers, if any, or with the unit's charger.	Disconnect any auxiliary chargers. Reset by moving Operating Mode Switch to "OFF". Wait 1 minute and switch to "AUTO/REMOTE" or "CHARGE ONLY." If unit remains in shutdown mode after several attempts to reset, contact Tripp Lite Customer Service for assistance.
	Unit has shut down due to excessive battery discharge.	Use an auxiliary charger* to raise battery voltage. Check external battery connections and fuse. Unit automatically resets when condition is cleared.
	Unit has shut down due to overload.	Reduce load. Reset by moving Operating Mode Switch to "OFF". Wait 1 minute. Switch to "AUTO/REMOTE" or "CHARGE ONLY".
Battery Not Recharging (AC Input Present)	Connected batteries are dead.	Check and replace old batteries.
	Battery fuse* is blown.	Check and replace fuse.*
	Battery cabling* is loose.	Check and tighten or replace cabling.*
	Unit has shut down due to battery overcharge (preventing battery damage). The problem may be with connected auxiliary chargers, if any, or with the unit's charger.	Disconnect any auxiliary chargers. Reset by moving Operating Mode Switch to "OFF". Wait 1 minute and switch to "AUTO/REMOTE" or "CHARGE ONLY." If unit remains in shutdown mode after several attempts to reset, contact Tripp Lite Customer Service for assistance.
	Input circuit breaker is tripped.	Reset circuit breaker.
All Three "BATT VOLT/CHRG CURR" LEDs are slowly flashing (½ second flashes) with Operating Mode Switch in the "AUTO/REMOTE" position.	Battery is excessively discharged. Unit will shut down to prevent battery damage.	Use an auxiliary charger* to raise battery voltage. Check external battery connections and fuse. Unit automatically resets when condition is cleared.
All Three "BATT VOLT/CHRG CURR" LEDs are rapidly flashing (¼ second flashes) with Operating Mode Switch in the "AUTO/REMOTE" position.	Battery is overcharged. Unit will shut down to prevent battery damage. The problem may be with connected auxiliary chargers, if any, or with the unit's charger.	Disconnect any auxiliary chargers. Reset by moving Operating Mode Switch to "OFF". Wait 1 minute and switch to "AUTO/REMOTE." If unit remains in shutdown mode after several attempts to reset, contact Tripp Lite Customer Service for assistance.
Red "LOW" Battery Indicator Light is flashing with Operating Mode Switch in the "AUTO/REMOTE" position.	Battery voltage is low. Unit has shut down to protect battery from damage.	If AC power (utility- or generator-supplied) is present, the unit will automatically reset itself and start recharging connected batteries. However, if an external charger is used to recharge the batteries, you will need to manually reset the unit by moving the Operating Mode Switch to "OFF" for two seconds then returning it to "AUTO/REMOTE".
	False reading due to undersized or insufficiently connected DC cabling.	Use sufficient size DC cable sufficiently connected to Inverter.
Red "LOAD" Operation Indicator Light flashing	Inverter is overloaded. Unit will automatically shut down after 5 seconds.	Reduce load. Reset by moving Operating Mode Switch to "OFF". Wait 1 minute. Switch to "AUTO/REMOTE" or "CHARGE ONLY".

* User-supplied.

Regulatory Compliance Identification Numbers

For the purpose of regulatory compliance certifications and identification, your Tripp Lite product has been assigned a unique series number. The series number can be found on the product nameplate label, along with all required approval markings and information. When requesting compliance information for this product, always refer to the series number. The series number should not be confused with the marking name or model number of the product.

This product designed and engineered in the USA. The policy of Tripp Lite is one of continuous improvement. Specifications subject to change without notice.



1111 W. 35th Street, Chicago, IL 60609 USA
Customer Support: (773) 869-1234
www.tripplite.com