

ZOOM

H2next

Handy Recorder

Operation manual

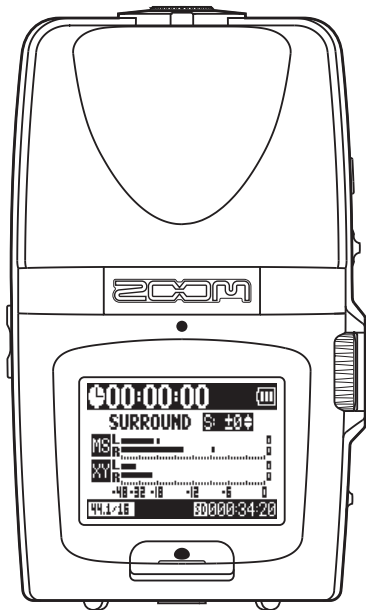

©ZOOM Corporation

Reproduction or duplication of this manual without permission, in whole or in part, is prohibited.

Usage and safety precautions

SAFETY PRECAUTIONS

In this manual, symbols are used to highlight warnings and cautions that you must read to prevent accidents. The meanings of these symbols are as follows:

 Something that could cause serious injury or death.

 Something that could cause injury or damage to the equipment.



Other symbols

 Required (mandatory) actions

 Prohibited actions



Warning

Operation using an AC adapter

-  Use only a ZOOM AD-17 (sold separately) AC adapter with this unit.
-  Do not use do anything that could exceed the ratings of outlets and other electrical wiring equipment. Before using the equipment in a foreign country or other region where the electrical voltage differs from that indicated on the AC adapter, always consult with a shop that carries ZOOM products beforehand and use the appropriate AC adapter.

Operation using batteries

-  Use 2 conventional 1.5-volt AA batteries (alkaline or nickel-metal hydride).



-  Read battery warning labels carefully.
-  Always close the battery compartment cover when using the unit.

Alterations





-  Never open the case or attempt to modify the product.

Precautions



Product handling

-  Do not drop, bump or apply excessive force to the unit.
-  Be careful not to allow foreign objects or liquids to enter the unit.



Operating environment

-  Do not use in extremely high or low temperatures.
-  Do not use near heaters, stoves and other heat sources.
-  Do not use in very high humidity or near splashing water.
-  Do not use in places with excessive vibrations.
-  Do not use in places with excessive dust or sand.



AC adapter handling

-  When disconnecting the AC adapter from an outlet, always pull the body of the adapter itself.
-  During lightning storms or when not using the unit for a long time, disconnect the power plug from the AC outlet.

Battery handling

-  Install the batteries with the correct +/- orientation.
-  Use a specified battery type. Do not mix new and old batteries or different brands or types at the same time. When not using the unit for an extended period of time, remove the batteries from the unit.
-  If a battery leak should occur, wipe the battery compartment and the battery terminals carefully to remove all battery residue.

Connecting cables with input and output jacks

-  Always turn the power OFF for all equipment before connecting any cables.
-  Always disconnect all connection cables and the AC adapter before moving the unit.

Volume

-  Do not use the product at a loud volume for a long time.

Usage Precautions

Interference with other electrical equipment

In consideration of safety, the **H2n** has been designed to minimize the emission of electromagnetic radiation from the device and to minimize external electromagnetic interference. However, equipment that is very susceptible to interference or that emits powerful electromagnetic waves could result in interference if placed nearby. If this occurs, place the **H2n** and the other

device farther apart. With any type of electronic device that uses digital control, including the **H2n**, electromagnetic interference could cause malfunction, corrupt or destroy data and result in other unexpected trouble. Always use caution.

Cleaning

Use a soft cloth to clean the panels of the unit if they become dirty. If necessary, use a damp cloth that has been wrung out well. Never use abrasive cleansers, wax or solvents, including alcohol, benzene and paint thinner.

Malfunction

If the unit becomes broken or malfunctions, immediately disconnect the AC adapter, turn the power OFF and disconnect other cables. Contact the store where you bought the unit or ZOOM service with the following information: product model, serial number and specific symptoms of failure or malfunction, along with your name, address and telephone number.

Copyrights

•Windows, Windows Vista, Windows XP and Windows 7 are trademarks or registered trademarks of Microsoft Corporation. •Macintosh and Mac OS are trademarks or registered trademarks of Apple Inc. •The SD and SDHC logos are trademarks. •The use of MPEG Layer-3 audio compression technology is licensed from Fraunhofer IIS and Sisvel SpA.

* All other product names, trademarks and company names in this document are the property of their respective owners.

Introduction

Thank you very much for purchasing a ZOOM **H2n** Handy Recorder.

The features of the **H2n** include the following.

- **Four-channel recording captures sound in 360°**

The built in microphones are divided into mid-side (MS) mics on the rear side and XY mics on the front side. This independent placement allows you to record sound coming from every direction. This unrestricted range means you can record diverse sound sources in all kinds of conditions.

- **New microphone array allows control of stereo width**

The MS mic includes a directional mid mic that covers the front and a bidirectional side mic that covers both sides. By controlling the amount of side mic signal, you can freely adjust the stereo width of recordings.

- **Stereo recording is clear and three-dimensional**

Using the XY mic, you can realize three-dimensional stereo recordings that faithfully capture a sense of depth.

- **Uninterrupted long recordings possible at high-quality**

Recording is possible without interruption for very long times. You can even fill an entire 32GB SDHC card in one session!

- **Runs for a long time on standard batteries**

You can record for up to 20 hours (44.1kHz/16bit WAV format) with one set of alkaline batteries. So, even in situations where you must rely on batteries, you can keep recording without worrying about the time.

- **Use as an SD card reader and computer audio interface**

The built-in USB 2.0 high-speed port allows direct connection with a computer. Use the recorder as an SD card reader with a computer to transfer recordings to your computer for use in DAW software or to burn them to CDs. You can even use the recorder as a computer audio interface at USB 1.0 speed.

- **Tuner, metronome and other practice features**

In addition to standard chromatic tuning, the tuner also supports seven-string guitar, five-string bass and alternate tunings. The convenient metronome can even provide a count in and the speed and pitch of playback can be adjusted, making it a useful practice companion.

Please read this manual carefully to fully understand the **H2n** so that you can maximize your use of its features. After reading the manual once, please keep it with the warranty in a safe place.

Contents

Usage and safety precautions.....	02
Introduction.....	04
Contents	06
Package contents.....	07
Part names.....	08
Display	10
Preparation	
Powering the recorder.....	12
Using batteries	12
Using an AC adapter (sold separately).....	12
Installing an SD card	13
Turning the power ON and OFF	14
Turning the power ON	14
Turning the power OFF.....	14
Using the hold function	15
Connecting an external mic	16
Using plug-in power.....	16
Setting the date and time.....	17
Setting the battery type	18
Recording	
Recording mode overview	20
Mid-side (MS) stereo mode.....	20
XY stereo mode.....	20
2ch and 4ch surround modes	21
Selecting the recording mode.....	22
Adjusting the S level (MS stereo, 2ch/4ch surround modes)	22
Using MS-RAW mode (WAV format only)	23
Selecting where recordings are saved	23
Recording manually.....	24
Recording automatically.....	26
Pre-recording.....	28
Counting in before recording	29
Playback	
Playing back recordings.....	30
Selecting the file to playback from a list	32
Changing the playback speed	33
Loop playback of a set interval (AB REPEAT) ..	34
Changing the play mode	36
Adjusting the playback pitch (KEY CONTROL)	38
Changing the S level (MS-RAW only)	39
Mixing a 4ch surround file.....	40
Checking & Editing Files	
Checking file information	42
Checking track marks (WAV files only).....	43
Changing file names (Stereo files only).....	44
Convert WAV files into MP3 files (Stereo files only)	46
Normalizing WAV files.....	48
Dividing files (Stereo files only).....	50
Deleting files	52
Deleting all files in a folder.....	53
Converting MS-RAW files into stereo files	54
Converting 4ch surround files into stereo files	56
Using USB	
Exchanging files with a computer (Card reader)	58
Audio interface use (MS/XY stereo and 2ch surround modes only).....	60
Tuner	
Using the tuner	62
Metronome	
Using the metronome.....	64
Various settings	
Reducing noise (LO CUT).....	66
Monitoring the input signal	67
Compressing/limiting the input signal	68
Automatically adjusting the input gain	70
Monitoring MS-RAW signals (MS stereo mode only)	71
Setting the recording format	72
Changing automatic recording settings.....	74
Setting how files are named (Stereo files only)	76
Pausing recording when adding marks (WAV format only)	77

Changing the display backlight time.....	78
Adjusting the display contrast.....	79
Checking the software versions.....	80
Restoring the unit to its factory settings.....	81
Checking the open capacity of the SD card.....	82
Formatting an SD card.....	83
Other functions	
Updating the system software.....	84
Using SD cards from older H series recorders.....	85
Using a remote control	86
Troubleshooting.....	87
Specifications.....	88

Package contents

Please confirm that the package contains the following items.

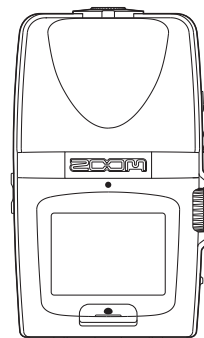

H2n recorder

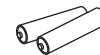

2 AA batteries
(for testing the unit)



WaveLab LE Download
access code sheet



SD card
(2GB)



Operation manual
(this document)

Part names

Part names

Part names

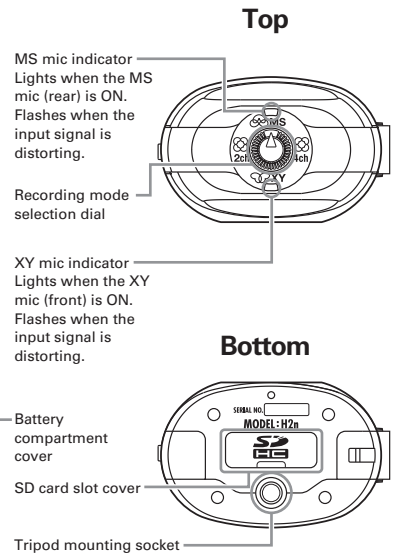
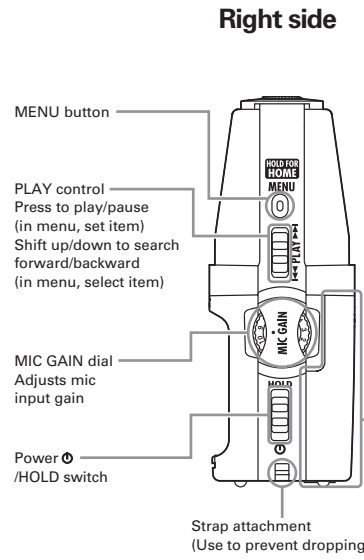
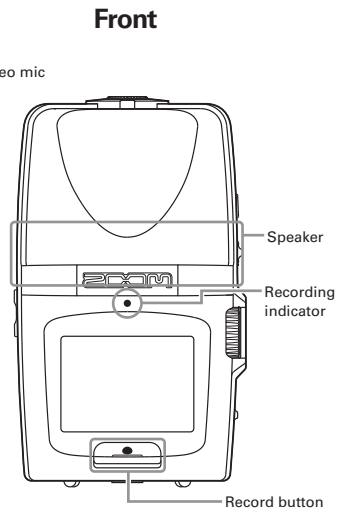
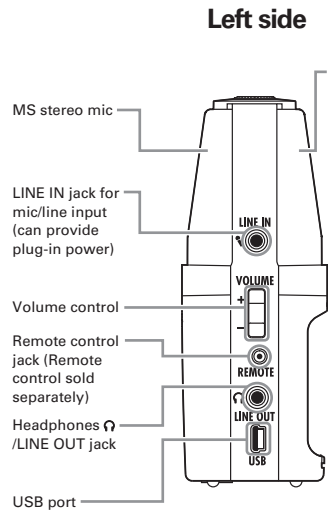

Display

Home (recording) screen

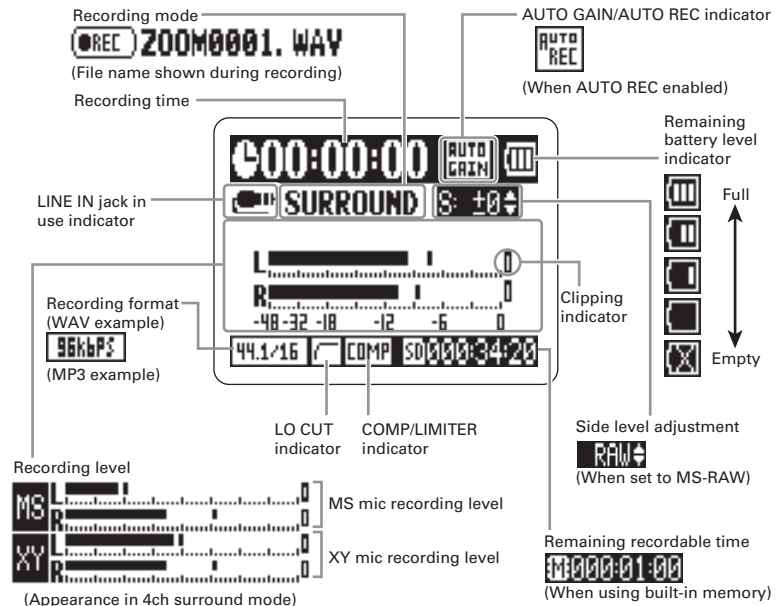

Playback screen

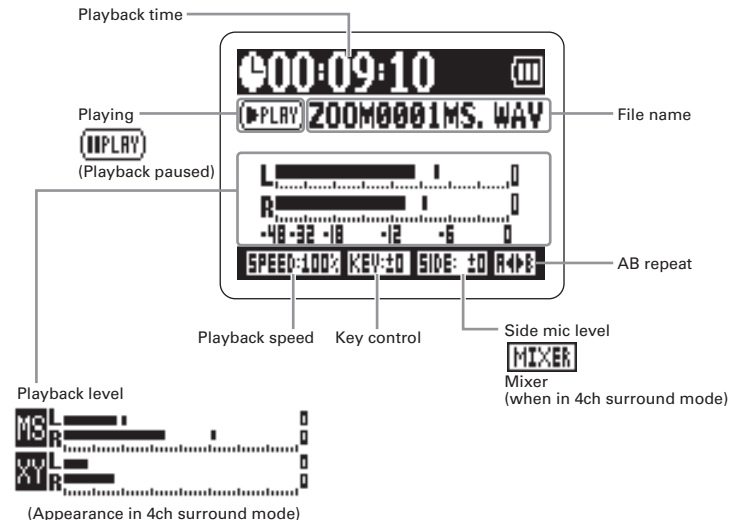

Powering the recorder

Using batteries

1. Turn the power OFF, and then remove the battery cover.
2. Insert batteries.
3. Close the cover.

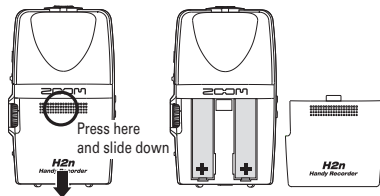

NOTE

- Use alkaline or nickel-metal hydride batteries.
- If the "Low battery!" warning appears, turn the power OFF soon and put in new batteries.
- Set the type of battery used. (→P.18)

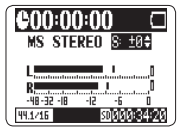

Using an AC adapter (sold separately)

1. Connect the cable to the USB port.
2. Plug the adapter into a power outlet.

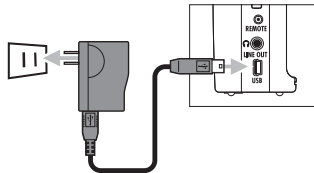

Installing an SD card

1. After turning the power OFF, open the SD card slot cover.
2. Insert the card into the slot.

To remove a card, push it further into the slot and then pull it out.

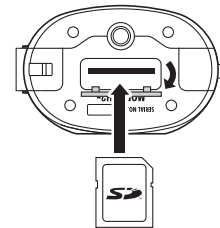

NOTE

- Always turn the power OFF before inserting or removing an SD card. Doing so when the power is ON could cause data to be lost.
- Be sure to insert the SD card correctly, using the cut-off corner illustration next to the slot as a guide.
- The built-in memory will be used if no SD card is in the recorder.
- Format the SD card if necessary. (→ P.83)

HINT

Built-in memory

- The built-in memory only keeps the most recent recording.
- The recording format is fixed at 96kbps MP3.
- It cannot be used to record in 4ch surround or MS-RAW modes.
- Recording time is limited to 1 minute.
- Recordings saved to the built-in memory cannot be copied to an SD card or a computer.

Turning the power ON and OFF

Turning the power ON

- Slide  down.

NOTE

- If "No SD card!" appears, confirm that an SD card is correctly inserted into the recorder.
- If "Card Protected" appears, SD card write protection is ON. Turn write protection OFF by sliding the "Lock" switch on the card.
- If "Invalid card" appears, the card format is incorrect. Use a different card or format the card. (→ P.83)



Turning the power OFF

- Slide  down and hold it until "Goodbye see you!" appears on the screen.



Using the hold function

In order to prevent accidental operation during recording, the **H2n** has a hold function that disables the use of controls other than the MIC GAIN.

Enabling the hold function

- Slide  up to the HOLD position.

NOTE

Even when the hold function is on, the remote control (sold separately) can still be used.



Disabling the hold function

- Slide  back to the middle.

Connecting an external mic

1. Connect an external mic (sold separately) to the **H2n** LINE IN jack.

NOTE

- An external mic can be used instead of the XY stereo mic.
- An external mic cannot be used with MS Stereo mode.

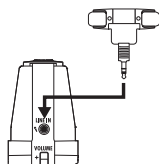

Using plug-in power

Make the following setting before connecting a mic that requires plug-in power.

1. Press **MENU**.

2. Use **↑/↓** to select INPUT, and then press **→**.

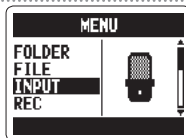

3. Use **↑/↓** to select PLUG-IN POWER, and then press **→**.

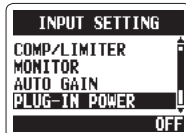

4. Use **↑/↓** to select ON, and then press **→**.

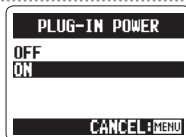

Setting the date and time

The date and time is added to recording files automatically, so set it correctly whenever the batteries are replaced.

1. Press **MENU**.

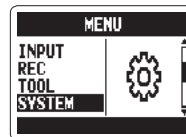

2. Use **↑/↓** to select SYSTEM, and then press **→**.

3. Use **↑/↓** to select DATE/TIME, and then press **→**.

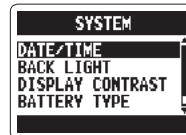

4. Adjust the settings.

Use **↑/↓** to move the cursor

Press **→** to select the item

Use **↑/↓** to change the value

Press **→** to confirm the setting



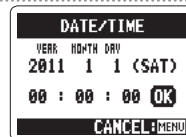

5. Use **↑/↓** to select OK, and then press **→**.



Setting the battery type

Set the battery type in order to show the remaining battery charge accurately.

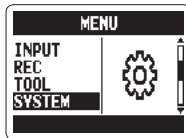

1. Press  .

2. Use  to select SYSTEM, and then
press  .

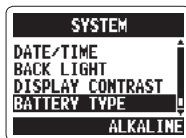

3. Use  to select BATTERY TYPE, and then
press  .



4. Use  to select the battery type, and then
press  .

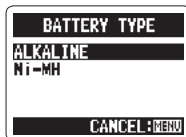

Recording mode overview

The **H2n** has four recording modes that can be selected according to your purposes.

Mid-side (MS) stereo mode MS

This mode uses a mid mic to capture the sound directly ahead and a bidirectional side mic to capture sound from left and right.

The recording level of the side mic (S level) can be adjusted, allowing the stereo width to be changed. If you record with the S level set to MS-RAW, you can also adjust the S level after recording.

MS mics can capture a rich stereo image, so it is ideal for recording sounds in wide and open conditions, including orchestras, live concerts and soundscapes.

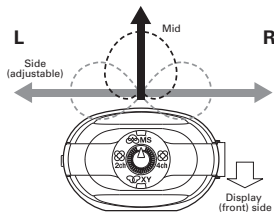

XY stereo mode XY

This mode records in stereo with mics at 90° angles. This allows a natural, deep and accurate sound image to be captured, making it optimal for recording sources nearby, including solo performances, chamber music, interviews, live rehearsals and field recordings.

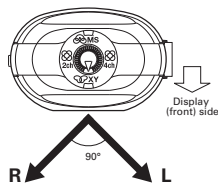

2ch and 4ch surround modes 2ch 4ch

Sound can be captured in all directions using both MS and XY mics.

You can select 2ch, which mixes the signals from the MS and XY mics, or 4ch, which records the signals from the MS and XY mics separately. With 4ch surround, you can adjust the balance between the MS and XY signals after recording. The S level can be adjusted for both 2ch and 4ch recordings.

These modes are suitable for recording live rehearsals, studio sessions, business meetings and soundscapes, for example.

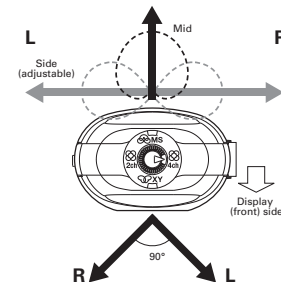

Selecting the recording mode

1. Turn  so that the triangle points to the desired mode.

NOTE

- The 4ch surround mode can only be used when an SD card is in the unit.
- In 4ch surround mode, only WAV formats (44.1/48kHz, 16/24bit) can be used.
- In 4ch surround mode, two stereo files are created (MS mic recording and XY mic recording).

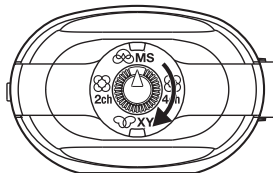

2. Make settings for the recording mode.

Adjusting the S level (MS stereo, 2ch/4ch surround modes)

You can adjust the stereo width (S level) before recording.

- Use  to adjust the stereo width.



NOTE

Set to OFF, RAW or between -24 and +6 dB.



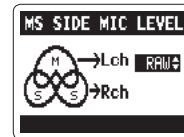

Using MS-RAW mode (WAV format only)

If you want to adjust the stereo width after recording, record using MS-RAW mode.

- Hold  down until RAW appears.



Selecting where recordings are saved

1. Press .
2. Use  to select FOLDER, and then press .
3. Use  to select the folder where you want to save files, and then press .

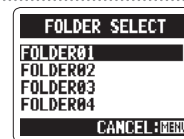
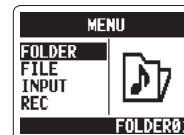

NOTE

Select from among 10 folders. There are separate sets of folders for stereo and 4ch recordings.

Recording manually

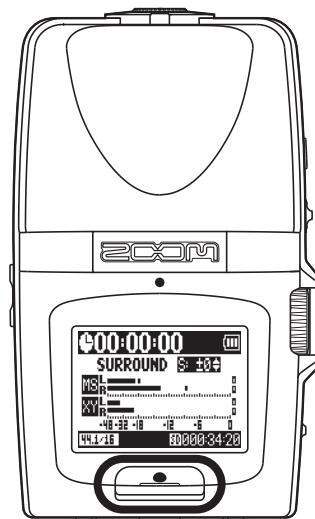

2, 4

1. Turn  to adjust the input level.

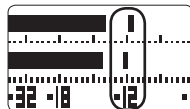
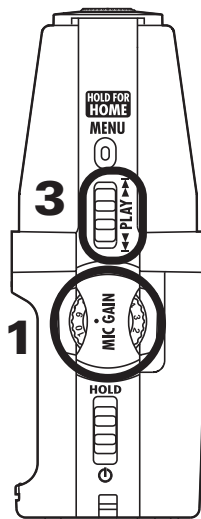
**HINT**

- Adjust the MIC GAIN so that the peak level stays around -12 dB.
- If an input signal is too strong, the MS/XY indicator on the top will flash immediately.
- The recorder can also adjust mic gain automatically. (→ P.70)
- You can change the recording format beforehand. (→ P.72)
- The mic can also be set to cut wind and other unwanted noise. (→ P.66)

2. Press  to start recording.

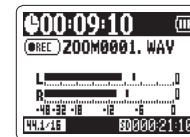

3. Press  to add a mark.

4. Press  to stop recording.

NOTE

- One file can have a maximum of 99 marks.
- The mic can also be set to pause immediately after adding a mark. (→ P.77)
- During recording, if the size of the file exceeds 2 GB, recording will continue in a new file that will be created automatically.



Recording automatically

The mic can be set to start and stop recording automatically in response to changes in the input level.

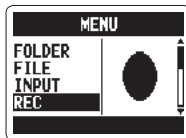

1. Press .

2. Use  to select REC, and then press .

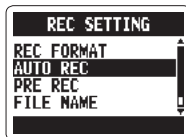

3. Use  to select AUTO REC, and then press .



4. Use  to select ON/OFF, and then press .



5. Use  to select ON, and then press .

NOTE

Other settings can also be made for automatic recording. (→ P.74)

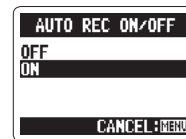

6. After the home screen reopens, press  to put the recorder in standby.

Recording will start automatically when the input signal exceeds the REC START LEVEL.

Recording will stop automatically when the input signal becomes less than the REC STOP LEVEL.

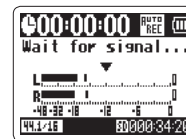

7. Press  to end recording standby and stop recording.

NOTE



Automatic recording can only be used with an SD card.





Pre-recording

When pre-recording is on, this recorder can continuously capture two seconds of sound before recording is started manually. When  is pressed, these two seconds are included at the beginning of the recording. This is useful when, for example, performances start suddenly.

1. Press .

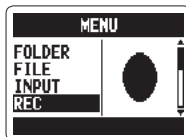
2. Use  to select REC, and then press .



3. Use  to select PRE REC, and then press .

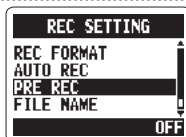

4. Use  to select ON, and then press .



5. Press  after returning to the home screen to start recording.



NOTE

- PRE REC cannot be used at the same time as the metronome PRE COUNT function.
- Pre-recording can only be used with an SD card.



Counting in before recording

The built-in metronome can play a count-in sound before recording starts. This pre-count sound is output through the /LINE OUT jack.

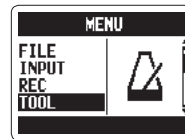

1. Press .

2. Use  to select TOOL, and then press .



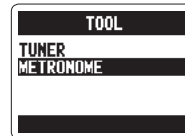

3. Use  to select METRONOME, and then press .

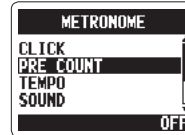

4. Use  to select PRE COUNT, and then press .



5. Use  to select the pre-count number, and then press .

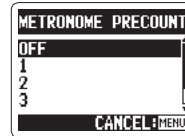

6. Press  after returning to the home screen to start pre-count and recording.

NOTE

- PRE COUNT cannot be used at the same time as PRE REC.

Playing back recordings

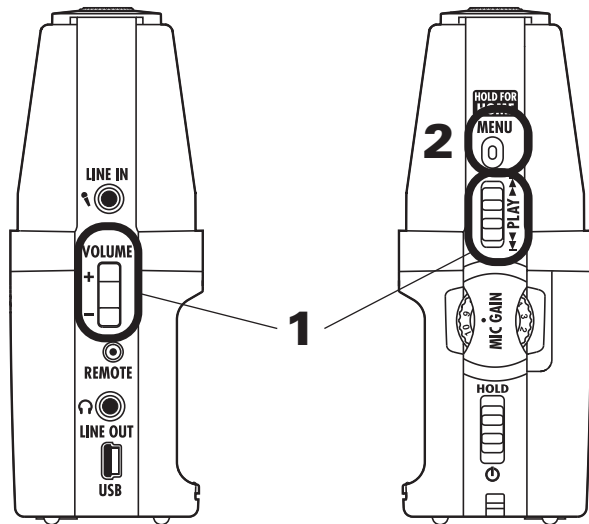



You can play files in the current folder. Change the folder to play files in a different folder.

- 1.** Press  .

Use  to jump between marks and files

Hold  to search forward or backward

Press  to pause and restart playback

Use  to adjust the volume



HINT

The longer you hold the PLAY control the faster it will search in that direction.



- 2.** Press and hold  to return to the home screen.





Selecting the file to playback from a list

You can select a file in the current folder for playback. Change the folder to select files from a different folder.

1. When the playback screen is open, press .

2. Use  to select FILE LIST, and then press .



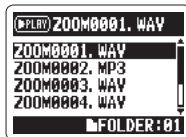

3. Use  to select a file, and then press  to start playback of that file.

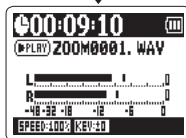

NOTE

After a file plays once, playback will stop or continue according to the PLAY MODE setting.





4. Press and hold  to return to the home screen.



Changing the playback speed

You can change the playback speed to between 50% and 150% of normal speed.

1. When the playback screen is open, press .

2. Use  to select SPEED, and then press .



3. Use  to set the playback speed, and then press .

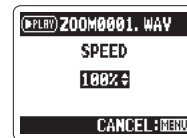

Files will be played at the set speed.

NOTE



The set value will be saved even when the power is turned OFF.



Loop playback of a set interval (AB REPEAT)

You can loop playback between two set points. Select the file that you want to play back first.

1. When the playback screen is open, press .

2. Use  to select AB REPEAT, and then press .



3. Press  at the point you want to start playback.

NOTE

Use  to search for the starting point quickly.



4. Press  at the point you want to stop playback.

Loop playback between the points will start.

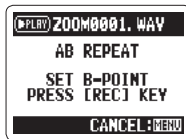

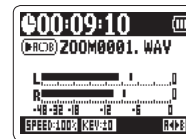

NOTE

- Use  to search for the stopping point quickly.
- If you set the stopping point before the starting point, they will be automatically swapped.



5. Press  to stop loop playback.

6. Use  to select STOP REPEAT, and then press .





7. Press .





Changing the play mode

1. When the playback screen is open, press  .

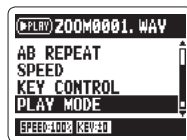
2. Use   to select PLAY MODE, and then press  .



3. Use   to set the mode, and then press  .



NOTE

PLAY ALL:	Play all the files in the current folder once.
PLAY ONE:	Play the current file once.
REPEAT ONE:	Play the current file repeatedly.
REPEAT ALL:	Play all the files in the current folder repeatedly.



4. Press  to start playback in the selected mode.





Adjusting the playback pitch (KEY CONTROL)

You can change the pitch without changing the playback speed.

1. When the playback screen is open, press  .

2. Use  to select KEY CONTROL, and then press  .



3. Use  to adjust the playback pitch, and then press  to start playback at the adjusted pitch.

NOTE

- The pitch can be adjusted by ± 6 semitones.
- The set value will be saved even when the power is turned OFF.
- KEY CONTROL cannot be used with 96kHz WAV files.

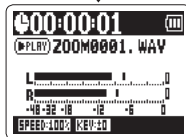
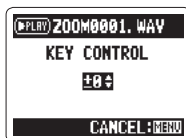



Changing the S level MS-RAW only

The S level (stereo width) of files recorded using MS-RAW mode can be changed. Select a file that has been recorded in MS-RAW mode first.



1. When the playback screen is open, press  .

HINT

If you select a file recorded using MS-RAW mode the  icon will appear.

2. Use  to select MS SIDE MIC LEVEL, and then press  .



3. Use  to adjust the S level, and then press  .



NOTE

Set to OFF or between -24 and $+6$ dB.

4. Press  to start playback with the adjusted S level.





Mixing a 4ch surround file

You can adjust the levels and panning of the MS and XY recordings made for 4ch surround files.

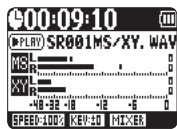
- Set the recorder to 4ch surround mode, select the file you want to mix, and then press .





- Press .

- Use  to select SURROUND MIXER, and then press .



- Change the values of the parameters.

Use  to move the cursor and change values

Push  to select a parameter to change

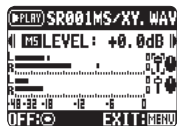

Parameter setting ranges		Explanation
MS LEVEL	MUTE, -48 ~ +12 dB	Adjusts volume
XY LEVEL	(0.5 dB increments)	
MS PAN	L100 ~ CENTER ~ R100	Adjusts left-right balance
XY PAN	(even values only)	

- Press  to turn the mixer ON or OFF.

NOTE

The mixer setting is only applied to playback. It does not change the recordings.



- Press  twice to return to the playback screen.

Checking file information

You can check various types of information about the current file.

1. Press .

2. Use  to select FILE, and then press .

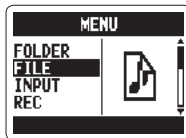

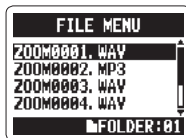

3. Select the file that you want to check, and

then press .



4. Use  to select INFORMATION, and then

press  to show information about the file.

Use  to scroll through the screen to see additional information

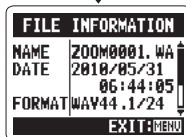
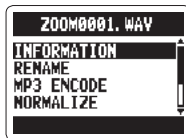

Checking track marks WAV files only

You can view a list of the marks in a WAV file.

1. Press .

2. Use  to select FILE, and then press .

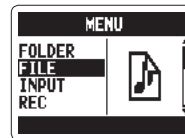

3. Select the file that you want to check, and

then press .

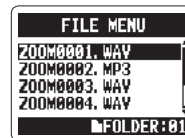

4. Use  to select MARK LIST, and then

press  to open the mark list.

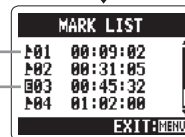
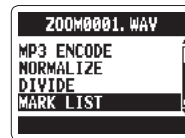

Shows an added mark



This mark appears when skipping occurred during recording

Changing file names Stereo files only

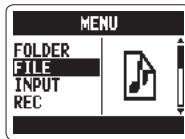

1. Press .

2. Use  to select FILE, and then press .

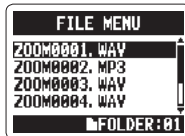

3. Use  to select the file name that you want to change, and then press .



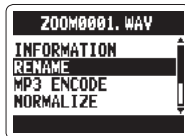

4. Use  to select RENAME, and then press .





5. Edit the name.



Use  to move the cursor and change characters

Push  to select a character to change and to confirm a change

6. Use  to select OK, and then press .

NOTE

- The following characters can be used in file names.
(Space)!#\$% &'()+,-0123456789;=@ABCDEFGHIJKLMN OPQRSTUVWXYZ[]^_`
abcdefghijklmnopqrstuvwxyz }~
- A file name cannot be only spaces.
- If a file with the same name already exists in the same folder, a warning appears and the screen shown in step five automatically reopens.



Convert WAV files into MP3 files Stereo files only

WAV files (other than MS-RAW) that have been recorded in any mode other than 4ch surround can be converted to MP3 files.

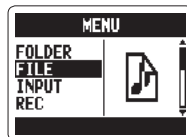

1. Press .

2. Use  to select FILE, and then press .



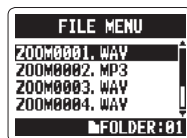

3. Use  to select the file you want to convert, and then press .



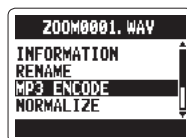

4. Use  to select MP3 ENCODE, and then press .



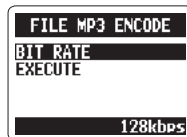

5. If you want to change the bit rate, use  to select BIT RATE, and then press .

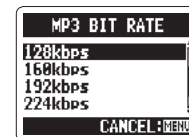

6. Use  to select the bit rate, and then press .



7. Use  to select EXECUTE, and then press  to start encoding.

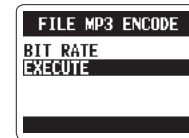

NOTE

- The converted file will be created in the same folder.
- If the SD card lacks open space, the screen shown in step 4 will reopen automatically.
- If a file already exists with the name that will be given to the converted file, the screen at right will appear. Rename the file before conversion.

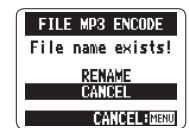



Normalizing WAV files

If the volume of a recording is lower than desired, you can raise the level of the recording as a whole.

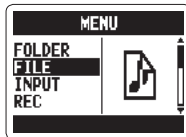

1. Press .

2. Use  to select FILE, and then press .



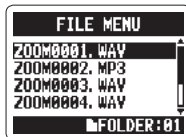

3. Use  to select the file you want to change, and then press .

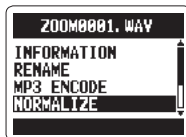

4. Use  to select NORMALIZE, and then press .



5. Use  to select YES, and then press  to start normalization.

NOTE

Normalization increases the overall level of the recording so that the maximum level in the file is 0 dB.

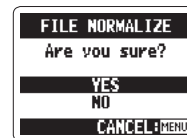



Dividing files Stereo files only

You can divide a file into two at any point.

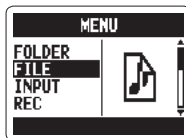

1. Press .

2. Use  to select FILE, and then press .

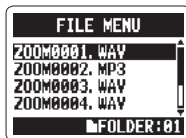

3. Use  to select the file you want to divide, and then press .



4. Use  to select DIVIDE, and then press .

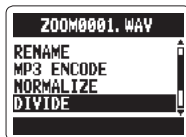

5. Set the dividing point.

Use  to move the point

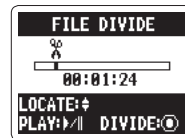

Press  to play and pause the file

Press  to confirm the dividing point



HINT

The longer you hold the PLAY control the faster it will search in that direction.

6. Use  to select YES, and then press .





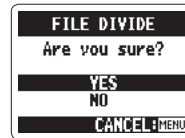



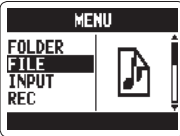

NOTE

- If a file already exists with the name that will be given to a divided file, rename the file before dividing.
- When a file is divided, "A" will be added to the end of the name of the file made from the part before the dividing point, and "B" will be added to the end of the name of the file made from the part after the dividing point.
- The original file is deleted.

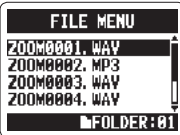

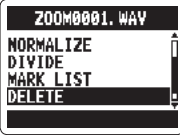







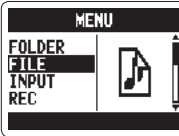

Deleting files

You can delete unwanted files.

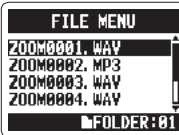
1. Press .
2. Use  to select FILE, and then press .
 
3. Use  to select the file you want to delete, and then press .
 
4. Use  to select DELETE, and then press .
 
5. Use  to select YES, and then press .
 

Deleting all files in a folder

You can delete all the files in the current folder at once.

1. Press .
2. Use  to select FILE, and then press .
 
3. Use  to select one file you want to delete, and then press .
 
4. Use  to select DELETE ALL, and then press .
 
5. Use  to select YES, and then press .
 



Converting MS-RAW files into stereo files

You can convert an MS-RAW file into a stereo file. S level (stereo width) adjustments will affect stereo files.

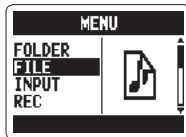

1. Press .

2. Use  to select FILE, and then press .



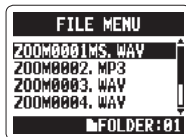

3. Use  to select the file you want to change, and then press .





4. Use  to select MS-RAW TO STEREO, and then press .

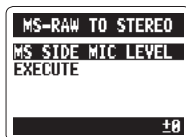

5. If you want to adjust the S level, use  to select MS SIDE MIC LEVEL, and then press .





6. Use  to adjust the S level, and then press .



NOTE

Set to OFF or between -24 and +6 dB.

7. Use  to select EXECUTE, and then press .

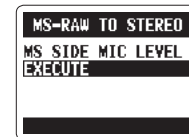

NOTE

- If a file already exists with the name that will be given to the converted file, you will have a chance to change the name to be given to the converted file.
- When a file is converted, the S level value will be added to the end of the name of the file.
- The original file is not deleted.





Converting 4ch surround files into stereo files

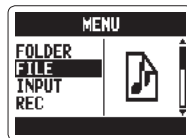

1. Press .

2. Use  to select FILE, and then press .





3. Use  to select the file you want to change, and then press .



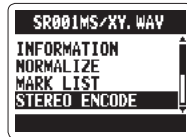

4. Use  to select STEREO ENCODE, and then press .





5. Use  to select MIXER, and then press .







6. Use  to select ENABLE or DISABLE, and then press .

NOTE

For an explanation about how to mix, see P.40.

7. Use  to select STORE IN, and then press .

8. Use  to select the folder where you want to save the file, and then press .

9. Use  to select EXECUTE, and then press  to start conversion.

NOTE

- If a file already exists with the name that will be given to the converted file, you will be given a chance to change the name to be given to the converted file.
- When a file is converted, "MIX" will be added to the end of the name of the file.
- The original file is not deleted.

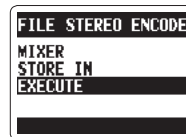
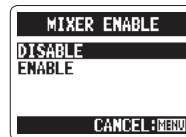

Exchanging files with a computer (Card reader)

You can connect the recorder to a computer to check and copy data on the SD card.

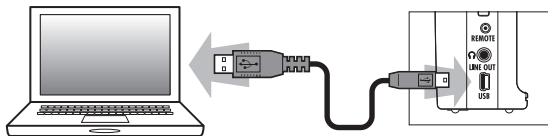

1. After turning the power on, connect the **H2n** to a computer by a USB cable.





NOTE

- To run the **H2n** using USB bus power, connect it to a computer by USB while the power is OFF.
- The **H2n** is compatible with the following operating systems.
Windows XP, Windows Vista, Windows 7, Macintosh OS X (10.2 or later)

2. Press .

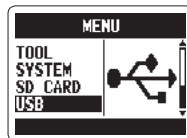
3. Use  to select USB, and then press .



4. Use  to select SD CARD READER, and then press .

The SD card will appear on the computer as a connected drive where you can check the files on it.

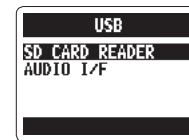

5. Unmount the card from the computer before disconnecting the recorder.

Windows: Use "Safely Remove Hardware" to select the **H2n**

Mac: Drag and drop the **H2n** icon into the Trash

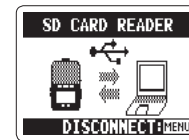

NOTE



Always follow the proper procedures on your computer to unmount the **H2n** SD card before disconnecting the USB cable.

6. Disconnect the cable from the computer and the **H2n**, and then press .



Audio interface use MS/XY stereo and 2ch surround modes only

You can record the signal from the **H2n** directly to a computer, and output the playback signal from a computer through the **H2n**.

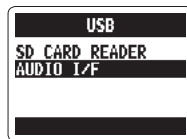

1. Follow steps 1–3 in “Exchanging files with a computer” on P.58.

2. Use  to select AUDIO I/F, and then press .

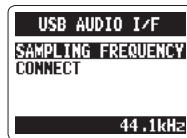

3. Use  to select SAMPLING FREQUENCY, and then press .



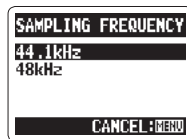

4. Use  to select the sampling frequency, and then press .



NOTE

Make sure that the sampling frequency settings are the same for both the **H2n** and the software you are using.

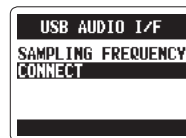

5. Use  to select CONNECT, and then press .





NOTE

- For information about the menu items that can be used see the following.

LO CUT (→P.66)	PLUG-IN POWER (→P.16)	AUTO GAIN (→P.70)
COMP/LIMITER (→P.68)	MONITOR (→P.67)	DISCONNECT INPUT
MS-RAW MONITOR (→P.71)	TUNER (→P.62)	
- If you want to send signals from the recorder to the computer, set INPUT to ON in the USB AUDIO MENU.

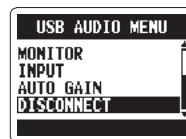
6. To disconnect the recorder, press , use  to select DISCONNECT, and then press .



7. Use  to select YES, and then press .

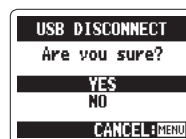

8. Disconnect the cable from the computer and the **H2n**.



Using the tuner

The built-in tuner can help you tune instruments by detecting the pitches of input signals.

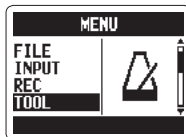

1. Press .

2. Use  to select TOOL, and then press .



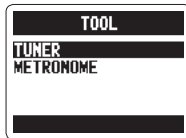

3. Use  to select TUNER, and then press .



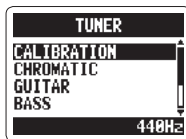

4. If you want to change the standard pitch, use  to select CALIBRATION, and then press .

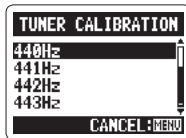

5. Use  to select the pitch you want to use, and then press .



6. Use  to select the tuner type, and then press .

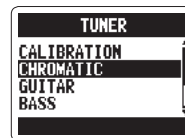

7. Tune the instrument.

The available tuner types work as follows.

■ Using the chromatic tuner

The input pitch is automatically detected and the nearest pitch is shown along with the amount of discrepancy.

The correct pitch is indicated by the middle circle

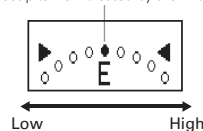

■ Using the guitar and bass tuners

The input pitch is automatically detected and the nearest string and pitch are shown along with the amount of discrepancy.

The correct pitch is indicated by the middle circle

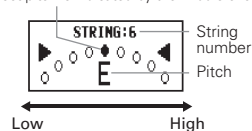

Tuner type	String number/pitch						
	1	2	3	4	5	6	7
GUITAR	E	B	G	D	A	E	B
BASS	G	D	A	E	B	-	-
OPEN A	E	C#	A	E	A	E	-
OPEN D	D	A	F#	D	A	D	-
OPEN E	E	B	G#	E	B	E	-
OPEN G	D	B	G	D	G	D	-
DADGAD	D	A	G	D	A	D	-



Using the metronome

You can use the metronome to count in before recording and to provide a guide tempo.

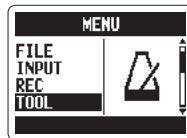

1. Press .

2. Use  to select TOOL, and then press .



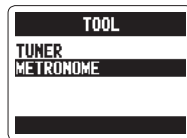

3. Use  to select METRONOME, and then press .

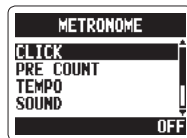

4. Use  to select the desired menu item, and then press .





■ Setting the CLICK

Use  to select when the click should sound, and then press .





■ Setting the PRE COUNT (→P.29)

■ Setting the TEMPO

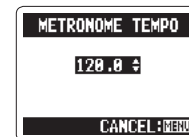
Use  to adjust the metronome tempo (BPM), and then press .



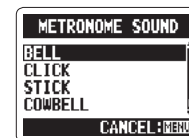

■ Setting the SOUND

Use  to select the metronome sound, and then press .



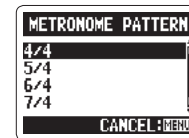

■ Setting the PATTERN

Use  to select the metronome pattern, and then press .



■ Setting the LEVEL

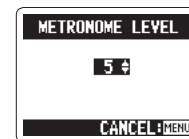

Use  to adjust the metronome volume, and then press .





Reducing noise (LO CUT)

The recorder can be set to reduce the sound of wind, vocal pops and other noise.

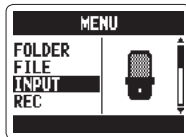

1. Press .

2. Use  to select INPUT, and then press .

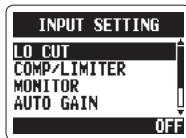

3. Use  to select LO CUT, and then press .



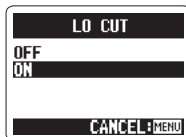

4. Use  to select ON, and then press .





Monitoring the input signal

You can listen to the input signal level through headphones.

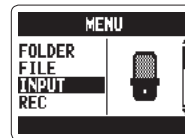

1. Press .

2. Use  to select INPUT, and then press .

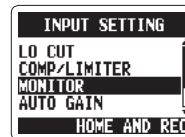

3. Use  to select MONITOR, and then press .



4. Use  to select when monitoring is enabled, and then press .

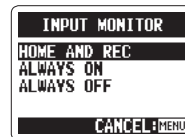



Setting	Explanation
HOME AND REC	Monitoring enabled when home screen open and when recording
ALWAYS ON	Monitoring always enabled
ALWAYS OFF	Monitoring disabled



Compressing/limiting the input signal

The recorder can be set to automatically increase the level of input signals that are too weak and decrease the level of input signals that are too strong for each input.

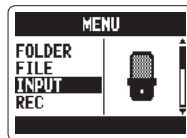

1. Press .

2. Use  to select INPUT, and then press .

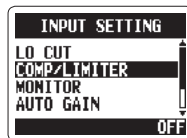

3. Use  to select COMP/LIMITER, and then press .



4. Use  to select the setting you want to use, and then press .

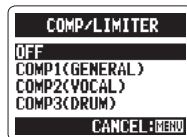

Setting	Explanation	
OFF	Compressor/limiter disabled	
COMP1(GENERAL)	Standard compressor	Compressors decrease high levels and increase low levels.
COMP2(VOCAL)	Compressor for vocals	
COMP3(DRUM)	Compressor for drums and percussion	
LIMIT1(GENERAL)	Standard limiter	Limiters reduce high levels that exceed a set threshold.
LIMIT2(CONCERT)	Limiter for live performances	
LIMIT3(STUDIO)	Limiter for studio recording	



NOTE

This cannot be used at the same time as the AUTO GAIN function.



Automatically adjusting the input gain

The recorder can automatically adjust the amount of gain used on signals input through the built-in microphones and the LINE IN input in order to avoid distortion.

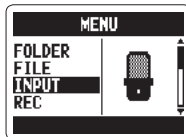

1. Press .

2. Use  to select INPUT, and then press .

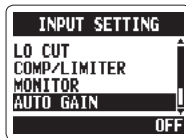

3. Use  to select AUTO GAIN, and then press .



4. Use  to select the setting you want to use, and then press .

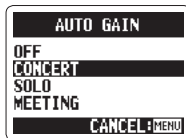

Setting	Explanation
OFF	AUTO GAIN disabled
CONCERT	For concerts and other loud sound sources
SOLO	For acoustic guitars and other solo performances
MEETING	For meetings and other quiet sound sources



NOTE

- When AUTO GAIN is ON, the MIC GAIN dial setting has no effect.
- This cannot be used at the same time as the automatic recording function.



Monitoring MS-RAW signals MS stereo mode only

When recording in MS-RAW mode, you can monitor the MID input signal on the left output channel and the SIDE input signal on the right output channel.

1. Press .

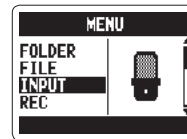
2. Use  to select INPUT, and then press .



3. Use  to select MS-RAW MONITOR, and then press .

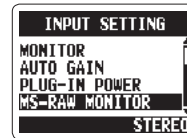

4. Use  to select RAW, and then press .

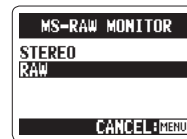



NOTE

If you want to monitor an ordinary stereo mix of the signals, select STEREO.



Setting the recording format

You can set the recording format according to your sound quality and file size needs.

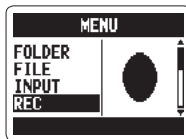

1. Press .

2. Use  to select REC, and then press .

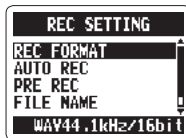

3. Use  to select REC FORMAT, and then press .



4. Use  to select the recording format, and then press .

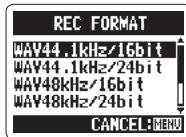

NOTE

- Use WAV formats for higher audio quality.
- Use MP3 formats, which are compressed and have much smaller file sizes, to save space on the SD card. Beware, however, that MP3 compression reduces audio quality.



Only these formats can be selected when using 4ch recording mode

	Sound quality	File size
	High	Large
WAV96kHz/24bit	↑	↑
WAV96kHz/16bit		
WAV48kHz/24bit		
WAV44.1kHz/24bit		
WAV48kHz/16bit		
WAV44.1kHz/16bit		
MP3 320kbps	↓	↓
MP3 256kbps		
MP3 224kbps		
MP3 192kbps		
MP3 160kbps		
MP3 128kbps		
MP3 112kbps		
MP3 96kbps		
MP3 80kbps		
MP3 64kbps		
MP3 56kbps	Low	Small
MP3 48kbps		



Changing automatic recording settings

You can change settings related to the input level threshold that causes recording to start and stop automatically, as well as the amount of delay before automatic stopping.

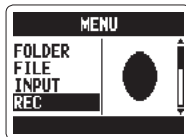

1. Press .

2. Use  to select REC, and then press .



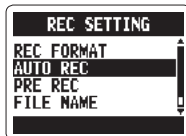

3. Use  to select AUTO REC, and then press .





4. If you want to adjust the recording start threshold, use  to select REC START LEVEL, and then press .







5. Use  to adjust the recording start threshold, and then press .





6. If you want to set the recording stop threshold, use  to select REC STOP LEVEL, and then press .



7. Use  to set the recording stop threshold, and then press .

8. If you want to set the delay before recording stops, use  to select AUTO STOP, and then press .



9. Use  to set the time, and then press .





NOTE

The AUTO REC STOP time is the delay until recording stops after the input level drops below the REC STOP LEVEL.



Setting how files are named Stereo files only

You can change how stereo files are automatically named.

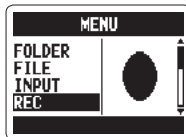

1. Press .

2. Use  to select REC, and then press .

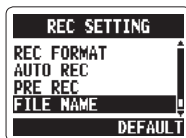

3. Use  to select FILE NAME, and then press .



4. Use  to select, and then press .

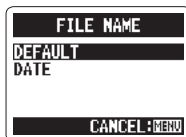

NOTE

- File names are assigned in the following manner.
DEFAULT: ZOOM0001(MS).wav/mp3 ~ ZOOM9999(MS).wav/mp3
DATE: YYMMDD-HHMMSS(MS).wav/mp3
(for example, 110531-130512.wav)
- DATE uses the starting time of the recording.
- If a file already exists with the same name in the folder, the new file will have a number added to the end of its name. Numbers will be added sequentially in the case of multiple duplicates.

Pausing recording when adding marks WAV format only

You can set the unit to pause when you add a mark during recording.

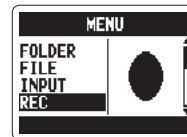

1. Press .

2. Use  to select REC, and then press .



3. Use  to select PLAY KEY FUNCTION, and then press .



4. Use  to select PAUSE AND MARK, and then press .

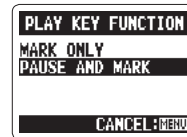

NOTE



Marks cannot be added to MP3 files, so this setting has no effect when recording MP3 files.

Changing the display backlight time

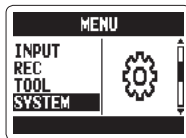

You can set the amount of time that the display backlight stays lit.

1. Press .



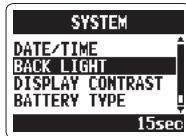

2. Use  to select SYSTEM, and then press .

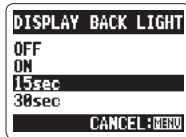

3. Use  to select BACK LIGHT, and then press .





4. Use  to select the amount of time, and then press .

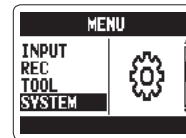

Setting	Explanation
OFF	The backlight stays unlit.
ON	The backlight stays lit when the unit is on.
15sec	The backlight stays lit for 15 seconds after the last time that a control (besides MIC GAIN) was used.
30sec	The backlight stays lit for 30 seconds after the last time that a control (besides MIC GAIN) was used.

Adjusting the display contrast



1. Press .

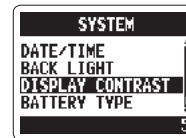

2. Use  to select SYSTEM, and then press .

3. Use  to select DISPLAY CONTRAST, and then press .



4. Use  to adjust the contrast, and then press .





NOTE

- The contrast can be set to a value from 1–8.
- The higher the number, the greater the contrast.



Checking the software versions

You can view the versions of the system and other software used by the **H2n**.

1. Press .

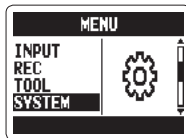
2. Use  to select SYSTEM, and then press .



3. Use  to select SOFTWARE VERSION, and then press  to show the software versions in use.

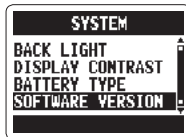



System software version





Restoring the unit to its factory settings

You can restore the recorder to the settings it had when it was shipped from the factory.

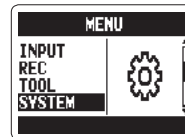

1. Press .

2. Use  to select SYSTEM, and then press .



3. Use  to select FACTORY RESET, and then press .



4. Use  to select YES, and then press .

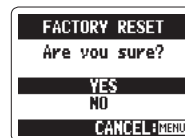



NOTE



- The date and time, recording mode and input gain settings are not reset by this.
- This also erases any recording in the built-in memory.

Checking the open capacity of the SD card

1. Press .

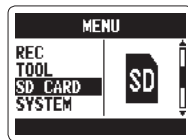
2. Use  to select SD CARD, and then press .



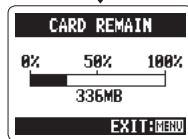
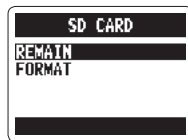

3. Use  to select REMAIN, and then press  to show the open space on the card.





Formatting an SD card

You can format an SD card for use with the **H2n**.

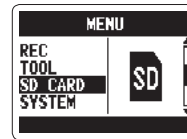

1. Press .

2. Use  to select SD CARD, and then press .

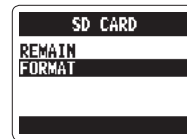

3. Use  to select FORMAT, and then press .



4. Use  to select YES, and then press .

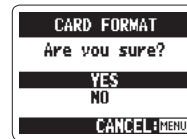

NOTE

- You must format an SD card after purchase or if it has been formatted by a computer or other device before using it with the **H2n**.
- Be aware that when you format an SD card, all data saved on it will be erased.

Updating the system software

You can update the system software used by your **H2n** to the latest version.

1. Copy the updater file to the root directory of the SD card.

NOTE

Download the latest system software at the ZOOM website (<http://www.zoom.co.jp>).

2. With the SD card in the **H2n**, turn the power

ON while pressing and holding .

3. Use  to select OK, and then press .

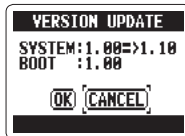

4. After updating completes, turn the power OFF.

NOTE



You cannot update the system software if the battery charge is low. In such a case, install new batteries or use an AC adapter (sold separately).



Using SD cards from older H series recorders

This recorder can read SD cards that have been used in older H series recorders and copy their files into folders for use by the **H2n**.

1. With the SD card inserted, turn the power ON.

2. Use  to select YES, and then press .

NOTE

A file must be renamed before moving if another file with the same name already exists in the **H2n** folder.

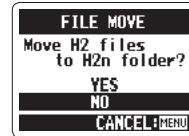

Using a remote control

By using a remote control (sold separately) you can operate the **H2n** from a distance.

- Connect the remote control to the REMOTE jack on the **H2n**.

The functions of the buttons on the remote are as follows.

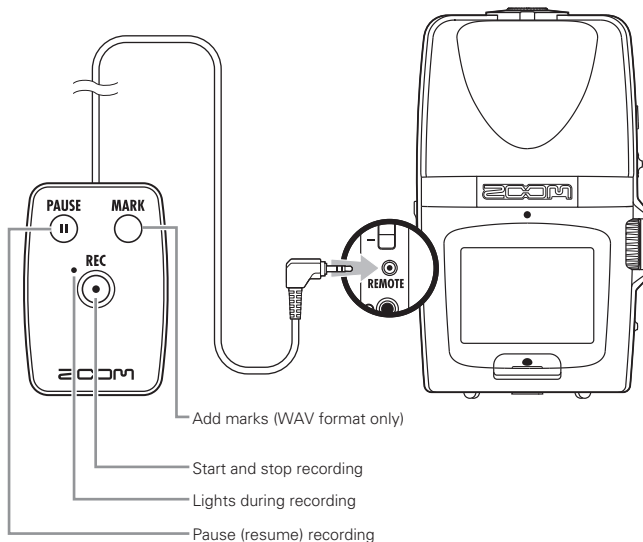

Troubleshooting

If you think that the **H2n** is not operating properly, please check the following first.

Recording/playback trouble

◆ There is no sound or output is very quiet

- Check the connections to your monitoring system and its volume setting.
- Confirm that the volume of the **H2n** is not too low.

◆ The recorded sound cannot be heard or is very quiet

- If you are using built-in mics, confirm that the active mics are oriented correctly and that the recording mode is suitable. (→ P.20)
- Check the MIC GAIN setting. (→ P.24, 70)
- If you are recording from a CD player or other device connected to the LINE IN jack, raise the output level of the connected device.

◆ Recording is not possible

- Confirm that the SD card has open space. (→ P.82)
- If "Hold" appears on the display, the hold function is enabled. Disable the hold function. (→ P.15)

Other trouble

◆ The recorder is not recognized by a computer when connected by USB

- Check that the OS of the computer is compatible. (→ P.58)
- The **H2n** operation mode must be selected on the recorder before it will be recognized by a computer. (→ P.58)

Specifications

Recording media	16MB–2GB SD cards, 4GB–32GB SDHC cards (Cards that can be used with this recorder are to be verified individually)	
Built-in memory	Can be used to record up to 1 minute in 96 kbps MP3 format (recording to this memory overwrites any previous recording in it)	
Recording	Mic arrangements	MS stereo with adjustable side mic level 90° XY stereo
	Modes	MS, XY, MS+XY (stereo) and MS+XY (4ch)
Microphones	Types	Directional (XY, MS mid mics) Bidirectional (MS side mic)
	Maximum sound pressure input	120 dB spl (directional) 122 dB spl (bidirectional)
File formats	Stereo	
	Uncompressed PCM	44.1/48/96kHz, 16/24bit WAV (BWF)
	Compressed MP3 (recording)	44.1kHz, 48/56/64/80/96/112/128/160/192/224/256/320kbps (Not compatible with MS-RAW recording)
	Compressed MP3 (playback)	44.1/48kHz, 32/40/48/56/64/80/96/112/128/160/192/224/256/320kbps
File formats	4ch	
	Uncompressed PCM	44.1/48kHz, 16/24bit WAV (BWF) Two stereo files for each recording
Digital processing	A/D conversion	24-bit 128x oversampling
	D/A conversion	24-bit 128x oversampling
	Signal processing	32-bit
Recording time	2GB card example	3:08:00 (44.1kHz/16bit WAV) 34:43:00 (128kbps MP3)
Features	LO CUT	80Hz high-pass filter
	COMP/LIMITER	3 types of compressors and 3 types of limiters
	AUTO GAIN	Automatic input gain adjustment
	PRE REC	2 seconds of pre-recording
	AUTO REC	Automatic recording start/stop, continuous standby
	TUNER	Chromatic, guitar, bass and alternate (A/E/G/D/DADGAD) tunings with automatic string detection
	METRONOME SPEED	40–250 BPM range, five tones, pre-count Playback speed adjustable between 50–150%

Features	KEY CONTROL	Playback pitch adjustable ± 6 semitones (cannot be used with 96kHz files)
	AB REPEAT	Repeats playback between selected points in a file
	FILE DIVIDE	Divides a file into two
	FILE NORMALIZE	Maximizes file volume (cannot be used with MP3s)
	FILE MP3 ENCODE MARK	WAV files can be converted to MP3 formats at fixed bit rates Up to 99 marks can be added as desired when recording WAV files
SURROUND MIXER	Mix balance can be adjusted when playing back 4ch surround recordings	
Display	Graphic LCD (128x64 pixels) with backlight	
Input gain	0 to +39 dB	
Input jack	Line/mic stereo mini jack can supply plug-in power 2 k Ω impedance at input levels of 0 to -39 dBm	
Output jack	Line/headphone stereo mini jack Rated output level: -10 dBm (output impedance 10 k Ω or more) Headphones: 20 mW + 20 mW (into 32 Ω load)	
Built-in speaker	400mW, 8 Ω , mono	
USB	Mini-B type Card reader operation USB 2.0 High Speed Audio interface operation USB 1.0 Full Speed Supports 44.1/48kHz sampling rates and 16-bit rate Bus power operation supported	
Power	AD-17 USB to AC adapter (DC 5V 1A), operates using two AA batteries Continuous operation of 20 or more hours when recording 44.1kHz/16-bit WAV files using alkaline batteries	
Physical features	Tripod mounting socket, strap attachment Dimensions (mm): 67.6 (W) x 113.85 (H) x 42.7 (D) Weight: 130 g (without batteries)	
Included accessories	Operation manual, SD card (2GB), 2 AA batteries, WaveLab LE Download access code sheet	

* Recording concerts and public performances, for example, without permission from rights holders is prohibited by law.

* Product specifications and appearance might be changed for the purpose of improvement without warning.

* 0 dBm = 0.775 Vrms

FCC regulation warning (for U.S.A.)

This equipment has been tested and found to comply with the limits for a Class B digital device, pursuant to Part 15 of the FCC Rules. These limits are designed to provide reasonable protection against harmful interference in a residential installation. This equipment generates, uses, and can radiate radio frequency energy and, if not installed and used in accordance with the instructions, may cause harmful interference to radio communications. However, there is no guarantee that interference will not occur in a particular installation. If this equipment does cause harmful interference to radio or television reception, which can be determined by turning the equipment off and on, the user is encouraged to try to correct the interference by one or more of the following measures:

- Reorient or relocate the receiving antenna.
- Increase the separation between the equipment and receiver.
- Connect the equipment to an outlet on a circuit different from that to which the receiver is connected.
- Consult the dealer or an experienced radio/TV technician for help.

For EU Countries



Declaration of Conformity:

This product complies with the requirements of EMC Directive 2004/108/EC, Low Voltage Directive 2006/95/EC and ErP Directive 2009/125/EC

Disposal of Old Electrical & Electronic Equipment

(Applicable in European countries with separate collection systems)



This symbol on the product or on its packaging indicates that this product shall not be treated as household waste. Instead it shall be handed over to the applicable collection point for the recycling of electrical and electronic equipment. By ensuring this product is disposed of correctly, you will help prevent potential negative consequences for the environment and human health, which could otherwise be caused by inappropriate waste handling of this product. The recycling of materials will help to conserve natural resources. For more detailed information about recycling of this product, please contact your local city office, your household waste disposal service or the shop where you purchased the product.



Zoom Corporation

4-4-3 Kanda-Surugadai, Chiyoda-ku, Tokyo 101-0062 Japan

<http://www.zoom.co.jp>