

# ACOUSTILYZER

## User Manual





NTI contact details:

NTI AG  
Im alten Riet 102  
9494 Schaan  
Liechtenstein, Europe  
Tel. +423 - 239 6060  
Fax +423 - 239 6089  
E-mail [info@nt-instruments.com](mailto:info@nt-instruments.com)  
Web [www.nt-instruments.com](http://www.nt-instruments.com)

© NTI AG  
All rights reserved.  
Subject to change without notice.  
Release 1.30e / May 2006 / Software A1.30 or higher

MiniLINK, Minilyzer, Digilyzer, Acoustilyzer, Minirator, MiniSPL and Minstruments are trademarks of NTI.



---

# Index:

<b>1. Introduction</b>	<b>4</b>
CE Declaration of Conformity	5
International Warranty and Repair	6
Warnings	7
Test & Calibration Certificate	7
<b>2. Overview</b>	<b>8</b>
Acoustilyzer Functions	9
Easy Operation	9
Connectors	10
<b>3. Basic Operation</b>	<b>12</b>
Start-up Screen	13
Menu Bar	13
<b>4. Measurement Functions</b>	<b>22</b>
SPL/RTA - Sound Level Meter	23
SPL/RTA - Real Time Analyzer RTA	27
Reverberation Time RT60	36
FFT Analysis	42
Polarity Test	46
Delay Time	48
Electrical Measurements - RMS/THD	51
Speech Intelligibility STI-PA (optional)	53
Calibration	61
<b>5. MiniLINK PC Software</b>	<b>64</b>
Installation	64
Start the MiniLINK PC Software	65
Free Registration of your Test Instrument	66
Read Out of Stored Test Results	67
Visualizing the Test Results	68
Test Result Logging at the PC	72
Remote Test Instrument Control with the PC	74
MiniLINK Tools	75
Activate Options	81
<b>6. Troubleshooting</b>	<b>82</b>
<b>7. Accessories</b>	<b>83</b>
<b>8. Technical Specification</b>	<b>85</b>
<b>9. Appendix: Introduction to STI-PA</b>	<b>88</b>



# 1. Introduction

Congratulations and thank you for buying NTI's Acoustilyzer AL1, a product specially suited for professional acoustical test applications. The Acoustilyzer offers advanced acoustics functions including an optional speech intelligibility STI-PA measurement module and further basic electrical features. We are convinced you will enjoy using it!

This manual describes the Acoustilyzer AL1 functions and measurements in detail. Further application information about the acoustical and electrical measurements can be found on the web site "[www.nt-instruments.com](http://www.nt-instruments.com)".

The Acoustilyzer AL1 is available as stand alone test instrument or as crossgrade package for existing Minilyzer ML1 users. The same crossgrade option can be used to install the Minilyzer functionalities on the AL1. The STI-PA measurement feature is optional.

The product packages includes the following items:

Acoustilyzer AL1	1x Acoustilyzer AL1 1x MiniLINK CD (PC software) 1x MiniLINK USB Cable 1x Acoustilyzer Test CD 1x Acoustilyzer User Manual
ML1-AL1 Crossgrade	1x MiniLINK CD (PC software) 1x Acoustilyzer Test CD (audio samples) 1x License Number Crossgrade 1x Acoustilyzer User Manual 1x Minilyzer User Manual
STI-PA Measurement Option	1x STI-PA Test CD (STI-PA test signal) 1x License Number STI-PA 1x Acoustilyzer User Manual



---

## CE Declaration of Conformity

We, the manufacturer

NTI AG  
Im alten Riet 102  
9494 Schaan  
Liechtenstein, Europe

hereby declare that the product Acoustilyzer AL1, released in 2004, conforms to the following standards or other normative documents.

EMC-Directives: 89/336, 92/31, 93/68  
Harmonized Standards: EN 61326-1

This declaration becomes void in case of any changes on the product without written authorization by NTI.

Date: 1. September 2004

Signature: 

Position of signatory: Technical Director





## **International Warranty and Repair**

### **International Warranty**

NTI guarantees the functionality of Acoustilyzer AL1 against defects in material or workmanship for a period of one year from the date of original purchase, and agrees to repair or to replace at its discretion any defective unit at no cost for either parts or labor during this period.

### **Restrictions**

This warranty does not cover damages caused through accidents, misuse, lack of care, the attachment or installation of any components that were not provided with the product, loss of parts, connecting the instrument to a power supply, input signal voltage or connector type other than specified or wrongly polarized batteries. In particular, no responsibility is granted for special, incidental or consequential damages.

This warranty becomes void if servicing or repairs of the product are performed by any party other than an authorized NTI service center or if the instrument has been opened in a manner other than specified in this manual.

No other warranty, written or verbal, is authorized by NTI. Except as otherwise stated in this warranty, NTI makes no representation or warranty of any kind, expressed or implied in law or in fact, including, without limitation, merchandising or fitting for any particular purpose and assumes no liability, either in tort, strict liability, contract or warranty for products.

### **Repair**

In case of malfunction, take - or ship prepaid - your NTI Acoustilyzer AL1 packed in the original box, to the authorized NTI representative in your country. For contact details see the NTI web page "[www.nt-instruments.com](http://www.nt-instruments.com)".

Make sure to include a copy of your sales invoice as proof of purchase date. Transit damages are not covered by this warranty.



## Warnings

In order to avoid any problems during the operation of the instrument, follow the rules listed below:

- **Use the instrument for the intended purpose only.**
- **Never connect the instrument to a high voltage output such as a power amplifier, mains power plug, etc.**
- **Do not disassemble the instrument.**
- **Never use the instrument in a damp environment.**
- **Remove the batteries as soon as they are flat or if the instrument is not intended to be used for a longer period of time.**

## Test & Calibration Certificate

This is to certify the Acoustilyzer AL1 is fully tested to the manufacturer's specifications. NTI recommends to calibrate this test instrument one (1) year after purchase. Thereafter the calibration- and adjustment interval is subsequently one (1) year.



## 2. Overview

The Acoustilyzer AL1 is a sophisticated tool used to analyze acoustical signals. It is designed for easy and quick detailed analysis of the acoustic environment and to carry out the most important electrical measurements. An accurate overview of the actual acoustical signal is displayed on a large LCD.

The AL1 is a class 1 accuracy instrument and available with the measurement microphones MiniSPL (class 2) or M2010 (class 1 frequency response). Alternatively other measurement microphones can be used.

### Class 1 acoustics analyzer

NTI offers the class 1 frequency response microphone M2010 (an external phantom power supply is required). The Acoustilyzer in combination with the M2010 measurement microphone forms a highly accurate class 1 acoustics analyzer.

### Class 2 acoustics analyzer

The Acoustilyzer in combination with the MiniSPL forms a comprehensive class 2 acoustics analyzer. MiniSPL is a battery powered measurement microphone. It is the ideal accessory for the Acoustilyzer.







## Acoustilyzer Functions

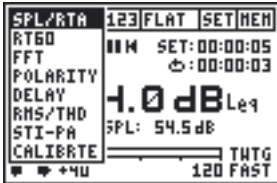

The Acoustilyzer AL1 features many measurement functions, which are accessible through a drop down menu bar.

The base element is the cursor (inverted area), which may be navigated through the various functions by using the cursor keys.

- **SPL/RTA:** Sound pressure level & time-averaged sound pressure level (LEQ) measurements of wideband, octave or 1/3 octave values
- **RT60:** Reverberation time with 1/1 octave band resolution
- **FFT:** Real time zoom FFT
- **POLARITY:** Polarity measurement of speakers and line signals
- **DELAY:** Delay time measurements between speakers
- **RMS/THD:** Level and distortion measurements
- **STI-PA:** Speech intelligibility measurement (only visible after received STI-PA license activation key)
- **CALIBRTE:** Calibration of connected measurement microphone

## Easy Operation

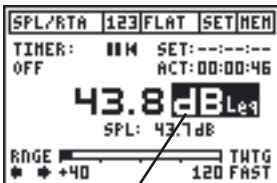

Unit selected with cursor to change setting

All selectable settings may be adjusted simply by

- Pressing the enter key to select the requested value.
- Alternatively at longer selection lists the chosen field is flashing. Now select the requested value with the cursor keys. Confirm the setting by pressing the enter key again.



## Connectors

On top of the AL1, three connectors as well as the internal microphone are located:

- The XLR and RCA inputs allow to feed a signal to the AL1.
- A 3.5 mm (1/8") jack monitor output allows the connection of a headphone. Thus, the user may hear any electrical input signal.
- The internal microphone is used to test the polarity of loudspeakers and for delay time measurements. SPL measurements are not supported with this internal microphone.

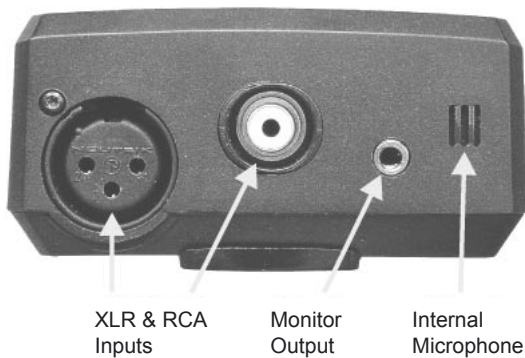

**Note: Never connect the XLR- and the RCA input at the same time!**

## Battery Replacement

After unpacking, insert three (3) pcs. 1.5 V alkaline batteries, type AA, LR6, AM3 into the AL1 battery compartment as shown below. The typical life-time for a set of alkaline batteries is 16 hours.



### Notes:

- We do not recommend to use rechargeable NiCd- or NiMH-batteries.
- Do not insert batteries of different types.
- Replace all batteries at the same time - never mix old and new batteries.
- Note the correct polarities of the inserted batteries.
- Remove the batteries as soon as they are flat and change all batteries at the same time.



### 3. Basic Operation

In spite of the wide range of available measurement functions and optional setups, the operation of the Acoustilyzer is almost self-explanatory.



The LCD is divided in the menu bar on top and the measurement results displayed below.

The cursor keys and the escape button allow straightforward navigation through the available features

- Actual settings (measurement function, filters)
- Measurement results (numerical or graphical display)

## Start-up Screen



The start up screen remains displayed by pressing and holding any button during the start up of the unit. This supports e.g. the read out of the instrument serial number from your device. The serial number starts with three letters (such as e.g. ANK675A2A2).

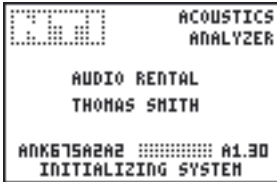

After the successful registration of the AL1 the start-up screen may be customized. See details in “Customizing start-up screen” later in this user manual.

## Menu Bar

The menu bar allows the selection of the basic test configurations.

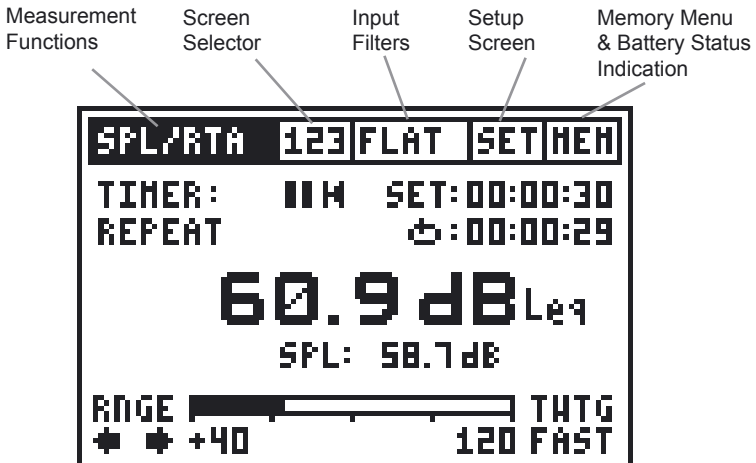



## Measurement Functions

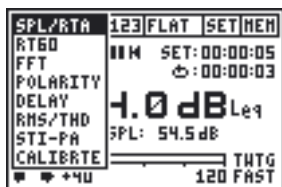

- SPL/RTA: SPL & RTA measurement
- RT60: Reverberation Time
- FFT: Real time zoom FFT
- Polarity: Speaker polarity
- Delay: Delay time
- RMS/THD: RMS level and distortion
- STI-PA: Speech intelligibility
- Calibrte: Calibration menu

## Screen Selector

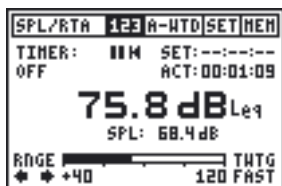

The Acoustilyzer features the SPL/RTA, RT60 and STI-PA function with two different test result screens.

e.g. the SPL/RTA “123” is showing the sound level meter screen and the marked graphical symbol shows the real time spectrum analyzer.

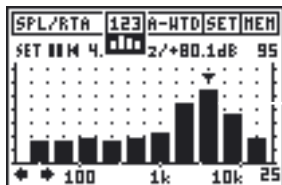

### Short-cut

Hold the ESC button down and additionally press the left or right arrow key to switch in-between the two display screens within the same measurement menu.



## Input Filters

Depending on the selected measurement functions the following sets of filters are available:

### SPL/RTA function:

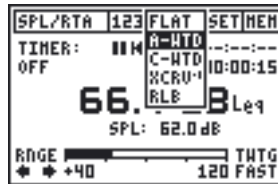

Filters	Applications
<b>FLAT</b> Flat frequency response (no filtering)	Overall sound pressure level, all sound signal components are included without weighting, required for special applications;
<b>A-WTD</b> A-weighting filter acc. IEC 61672	Applicable for most common sound pressure levels if level weighting following the human ear is required.
<b>C-WTD</b> C-weighting filter acc. IEC 61672	Applicable for high sound levels if level weighting following the human ear is required. Verify the filter setting with the test specifications.
<b>X-CRV<sup>1</sup></b> Inverted X-Curve filter acc. ISO 2969	Required for cinema installations
<b>RLB (=Revised Low frequency B-curve)</b> Broadcast Loudness filter acc. AES Paper "Loudness Assessment of Music and Speech" 2004	Applicable for loudness measurement of broadcast material. The revised B-weighted Leq measurement (=RLB) correlates the best to the subjective experience by humans.



## RMS/THD function:

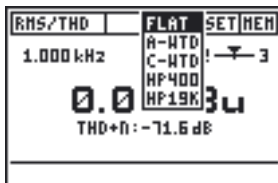

Filters	Applications
<b>FLAT</b> Flat frequency response (no filtering)	Default measurement setting.
<b>A-WTD</b> A-weighting filter	Measuring residual noise of the unit under test acc. IEC 61672 e.g. in sound broadcasting applications.
<b>C-WTD</b> C-weighting filter acc. IEC 61672	Special applications.
<b>HP400</b> Highpass 400 Hz acc. DIN 45045, -120dB/dec.	Removes any mains frequency (50/60Hz) components from the test signal.
<b>HP19k</b> Highpass 19 kHz	Removes any low frequency components from the test signal, e.g. to measure any 20kHz pilot tone level of critical public announcements systems.



## Setup Screen

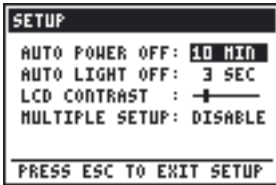

The setup screen allows to customize basic settings of the Acoustilyzer AL1 by the following procedure:

- Move the cursor to the corresponding field and press the enter key.
- Select the required status by using the arrow keys.
- Press the enter key to confirm.

**AUTO POWER OFF** defines the time the AL1 is switched OFF automatically after the last key-press. The available settings are 3 MIN, 10 MIN, 30 MIN, 60 MIN and DISABLE. In case DISABLE is selected, the user has to turn the unit off manually or it will run until the batteries are discharged.

### Acoustilyzer operation with MiniLINK PC Software

During the operation of the AL1 with the MiniLINK PC software, the AL1 is powered from the PC and the following power saving functions are disabled:- Auto Power Off - Auto Light Off. After the PC software MiniLINK is switched off the Acoustilyzer is continuously further powered from the PC but the power saving features are enabled again.

**AUTO LIGHT OFF** defines how long the backlight stays on after any key stroke. Possible selections are 3 SEC, 10 SEC., 60 SEC. and DISABLE. In the latter case, the backlight will stay on, until the unit is switched off. The longer the backlight is turned on, the shorter lifetime of the batteries will be.

**LCD CONTRAST** adjusts the contrast of the display. Alternatively, hold the ESC button down and press the up/down arrow key simultaneously in any measurement panel.

**MULTIPLE SETUP** allows to store up to four individual settings. To enable the multiple setup mode, set the corresponding entry to ENABLE and confirm. At the next time the Acoustilyzer is switched on, the user will have to select the individual setup-ID (1, 2, 3 or 4) in the startup screen. All parameter settings in all measurement modes are now stored under this ID at switch off.



## Memory Menu & Battery Status Indication

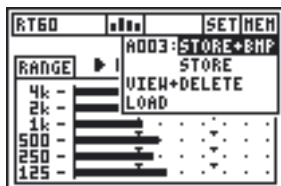

All measurements can be stored into the internal instrument memory. Each record is saved with a file name consisting of the test mode and a continuous running number from 000 - 999, such as “A001\_RMS\_THD” or “A002\_RT60”. The running number starts after 999 with 000 again.

You can store the test results as follows:



- **STORE+BMP**

Saves the numeric test results including the graphical screenshot, indicated by BMP (=bitmap) in the memory overview.



- **STORE**

Saves the numeric test result, so occupying less memory space.



- **VIEW + DELETE**

The stored measurement results are listed in ascending order from bottom to top, so the latest recorded measurement is always on top of the list. The remaining memory space is displayed in the right-upper corner of the screen.

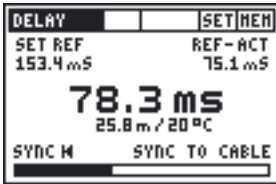
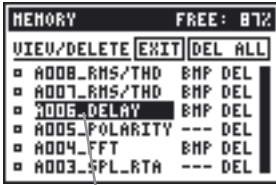

All screenshots marked with BMP can be reviewed directly on the instrument.

- Select any record in the list using the cursor.
- Press and hold the enter key.
- The recorded measurement is displayed on the instrument screen
- The selected record is marked in the memory menu by the full square in the front. You can recall the marked record at any time later by holding down the ESC button and pressing the enter key simultaneously.



### Delete individual memory records

Each stored result can be deleted individually from the memory.

- Select the DEL field beside the memory location to be deleted.
- Confirm OK within the pop up window and press the enter key.
- The memory location is deleted from the device memory.



### Delete all memory records

The complete memory can be deleted by selecting the field "DEL ALL".

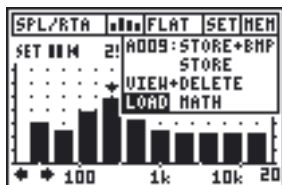

## LOAD

Various Acoustilyzer functions support the test result data loading from the internal AL1 memory. This feature is very useful for detailed test result read out of previously stored measurements on the test instrument.

The following measurements support this feature:

- SPL/RTA
- RT60
- FFT
- STI-PA

**Note:** Any ongoing measurement is continuing during loading and reading a memorized test result.

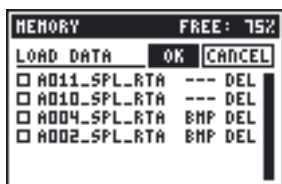

## Application example using SPL/RTA:

- Select LOAD in the memory menu and press enter.
- The possible memorized data for loading are displayed.

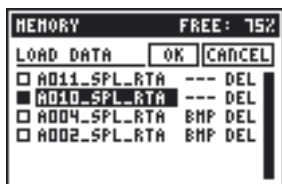

- Select the test result of interest.
- Confirm the selection with the enter key → the square symbol in front of the selection is filled up.
- Press the ESC button (cursor jumps to OK) and confirm with enter.

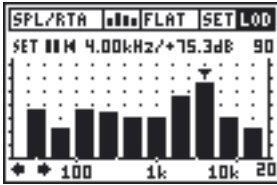

The loaded test result is displayed on the active AL1 screen and the abbreviation LOD is flashing in the status bar memory field.

The individual band levels can be read out, the Y-axis altered or even the Leq or min/max. test result shown. Non-available functionalities are not selectable.

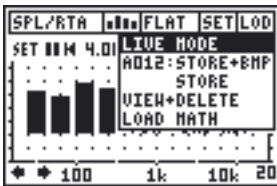

Return back to the live mode by selecting LIVE MODE in the memory menu of the upper menu bar.

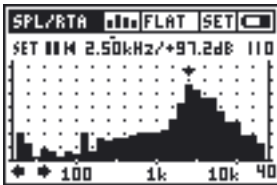

### Low battery indication

A low battery symbol is displayed in the “MEM” field of the menu bar to indicate that a change of batteries is required.



## 4. Measurement Functions

### Overview

Function	Test Result Screens	Test Features
SPL/RTA		<b>Sound Level Meter</b> Sound pressure level SPL, MAX/MIN SPL, LEQ, LcPEAK
		<b>Real Time Analyzer</b> 1/1 and 1/3 octave real time spectrum analyzer showing SPL, MAX/MIN SPL & LEQ per band
RT60		<b>Reverberation Time</b> in octave band resolution based on T20 results
		<b>Reverberation Time</b> detailed test results listed in seconds including correlation factor
FFT		<b>Real-time Zoom FFT</b>
POLARITY		<b>Polarity Test</b> of acoustical speaker or electrical line signals
DELAY		<b>Delay Time</b> Propagation delay measurement between electrical reference and acoustical signal
RMS/THD		<b>Electrical Measurements</b> Level RMS, THD+N, Frequency
STI-PA		<b>Speech intelligibility</b> of public announcement systems in STI or CIS test results (only visible after received STI-PA license activation key)
		<b>Speech intelligibility</b> Individual LEQ and STI-PA modulation indices of test frequency bands
CALIBRTE		<b>Calibration Menu</b> for external measurement microphones, sensitivity set by default to NTI MiniSPL



## SPL/RTA - Sound Level Meter

The Acoustilyzer features a comprehensive, integrating sound level meter with timer for single or repeated measurements. All results may be logged into the internal memory for further investigations.

The measurements displayed on the big and small result position may be altered between

- SPL Actual sound pressure level
- MIN SPL Minimum sound pressure level
- MAX SPL Maximum sound pressure level
- LEQ time-averaged sound pressure level
- PreLEQ LEQ of the previous timer period (only available when timer is in repeat mode)
- LcPEAK: C-weighted peak sound pressure level

The included Timer allows automatically to

- Stop the LEQ, LcPEAK and MAX/MIN SPL measurements after a user defined time
- Reset the LEQ, LcPEAK and MAX/MIN SPL measurements after a user defined time to start a new measurement.

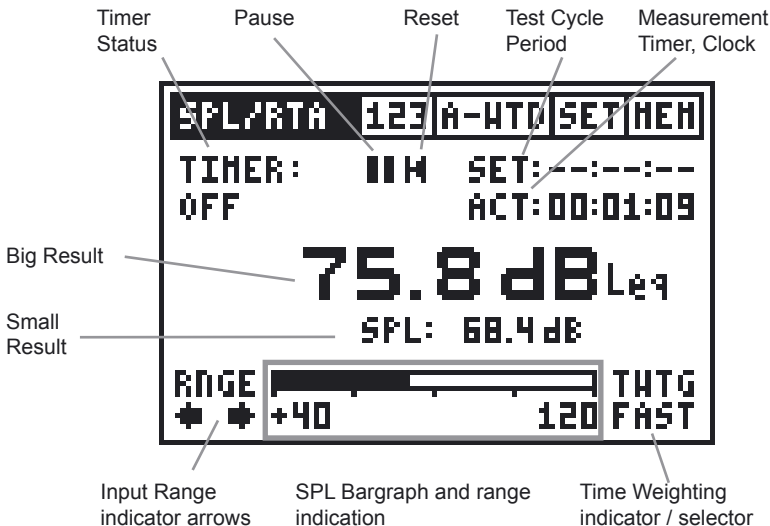



## Test Applications: “Timer Status” Setting

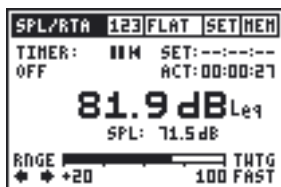

### TIMER OFF

(applicable for standard measurements)  
All values are recorded and monitored continuously. The measurement timer shows the actual testing period length. Pressing the RESET icon sets the clock and the test results back to zero.

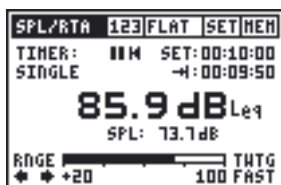

### TIMER SINGLE

Sound pressure level measurement with user defined time setting.

- Set the required test cycle period.
- The clock counts back to zero. After the defined test time is completed the clock is flashing as "00.00.00".
- The test results LEQ, LcPEAK and MAX/MIN SPL are frozen.
- Changing the test cycle period setting or pressing the RESET icon restarts the measurement.

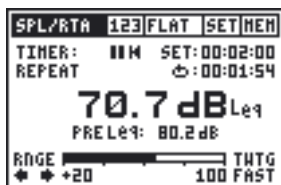

### TIMER REPEAT

Automatically repeating measurements with user-defined test time interval.

- Set the required test cycle period.
- The measurement timer counts back to zero. When the test time is elapsed the clock and the test results are reset and a new measurement is started.
- The previously measured LEQ is displayed as PreLEQ (very useful for LEQ monitoring at concerts)
- Changing the test cycle period or pressing the RESET icon restarts the measurement.



**Pause:** The LEQ, LcPEAK and MAX/MIN measurements can be paused

- Select the PAUSE symbol and press the enter key.
- The PAUSE symbol is flashing.
- The actual SPL value is continuously measured and displayed.
- Select the pause symbol and press the enter key to continue the measurement, visible by the continuing counting clock.

**Reset:** Pressing the RESET icon restarts the measurement. The timer and test results are reset.

**Test Cycle Period:** Applicable in SINGLE and REPEAT timer status only.



- SINGLE: Set to 10 min by default
- REPEAT: Set to 10 sec by default

**Measurement Timer:** Actual measurement in hours:minutes:seconds.

**Big and Small Result:** Two of the previous listed measurements may be display at the same time.

**Time Weighting:** All SPL measurements (SPL and MAX/MIN SPL) are time weighted measurements. Changes in the SPL level are smoothed resulting in quicker or slower change of the displayed value. Available time weightings, corresponding to IEC 61672, are

- SLOW (long attack- and release response time,  $t = 1s$ )
- FAST (short attack- and release response time,  $t = 125ms$ )

The time weighting for the broad band values () and the RTA () are always the same.

## Overload

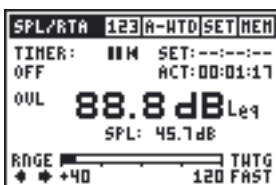

The OVL (Overload) is flashing if the input voltage exceeded the selected input range of the instrument. As long as the OVL is flashing the displayed LEQ and LcPEAK result is not accurate.



## Input Range Selector & Bargraph



In the SPL/RTA Mode the AL1 has three measurement ranges. The span of each range depends on the sensitivity of the used microphone. For a MiniSPL with a sensitivity of 20mV/Pa the measurement ranges are:

20 to 100 dB

40 to 120 dB

60 to 140 dB

The selected input range is displayed at the bottom of the bargraph and may be changed by operating the range indicator arrows. The bargraph provides an analog display of the actual sound pressure level.

## Primary Indicator Range



To achieve best measurement accuracy the appropriate range must be selected, called “primary indicator range”. Correct setting avoids overflow indications and lowers the influence of noise on the measurement result.

The two range indicator arrows assist the user to set the optimal range. As soon as the indicated bargraph value is found lower than the primary indicator range, the down arrow symbol below RNGE will start to move, symbolizing the actual SPL measurements are inaccurate. The bargraph range needs to be changed manually by selecting the moving left arrow symbol and pressing the enter key.

**Note: Changing the ranging resets all ongoing measurements.**



By exceeding the primary indicator range three overload arrows replacing the big result reading.

- Select the right arrow below RNGE and press enter to change to the next higher bargraph range.

## SPL/RTA - Real Time Analyzer RTA

The Acoustilyzer sound level meter features the individual 1/3<sup>rd</sup> or full octave band test results using class 0 filters. The SPL, MAX / MIN and LEQ values are displayed per band.

Stored spectra may be averaged by using the available mathematical functions. The MAX-MIN display is particularly helpful for characterizations of listening areas.

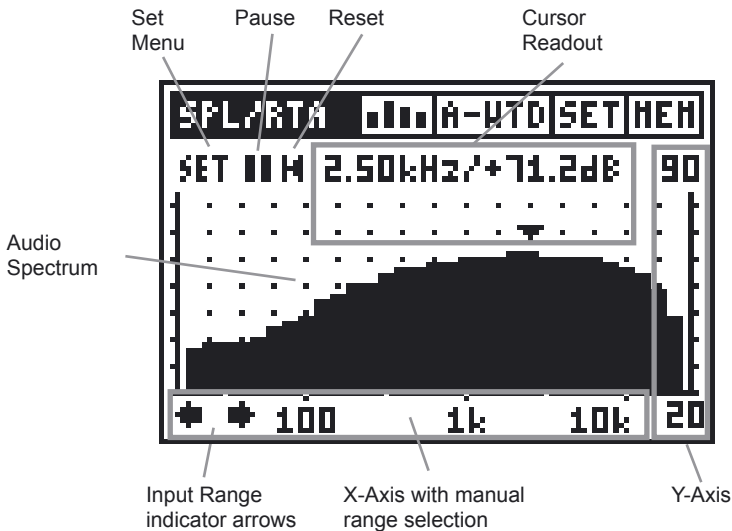

The audio spectrum is displayed without interrupting any ongoing sound level measurements, so e.g. changing from to screen will not interrupt the ongoing sound level measurements.

### Input Filter

The SPL/RTA input filter for the broad band values () and the RTA () may be selected independently - so e.g. a FLAT RTA is available while the broad band values are acquired using an A weighted filter. Please note that only various filter combinations are possible.

**Note: Changing filter settings re-starts the ongoing measurement.**



## Set Menu

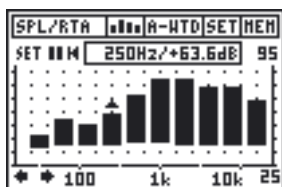
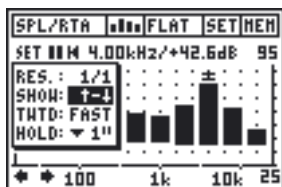
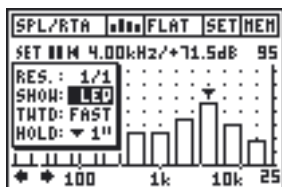
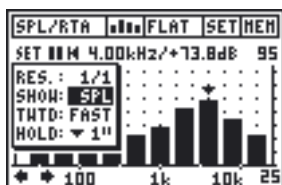
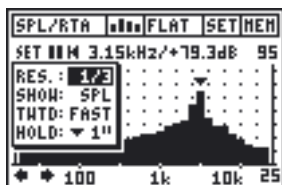
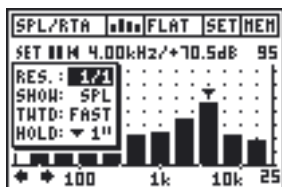

The SET menu allows for particular measurement settings and display options as listed below:

### RES - Resolution

Select 1/3<sup>rd</sup> octave or full (1/1) octave band resolution by pressing the enter key.

### SHOW - Test Result

The actual SPL, MAX/MIN SPL and LEQ can be displayed per band.

The actual SPL is displayed with filled bars.

The LEQ spectrum is displayed with framed bars.

The MAX/MIN SPL range is displayed with filled bars. The cursor read out shows either the maximum, the max-min difference or the minimum sound pressure level of the selected band.

Simply toggle through these results with upper & lower arrow keys:

- ▲ - max. SPL
- ▼ - min. SPL
- ± - max. - min. SPL

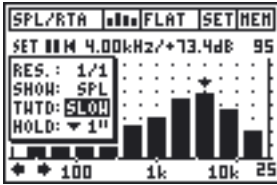

### TWTD - Time Weighting

Applicable for the actual sound pressure level measurement. The available response times, corresponding to IEC 61672, are

- SLOW (long attack- and release time)
- FAST (short attack- and release time)

The time weighting for the broad band values (**LEQ**) and the RTA view (**RTA**) are always the same.

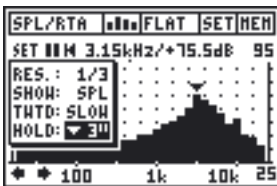

### HOLD - Cursor Hold

The cursor indicates the band of highest sound pressure level. For simple read out and traceability the cursor can remain for 1 - 9 seconds at the frequency band with the highest level. This may e.g. support finding of feedback frequencies.

**Cursor Readout:** Actual level result in the indicated frequency band.

The cursor readout displays the center frequency and the level of the band pointed to by the arrow. The cursor automatically jumps to the highest level band in the spectrum.

Alternatively the cursor readout may be controlled manually:

- Select the read out data field and press the enter key.
- A frame is flashing around the data readout.
- Move the cursor and read the corresponding test results.

### Pause / Reset / Input Range Indicator / TWTD - Time Weighting:

These controls are exactly the same as found on the sound level meter screen and also effect both, the RTA and the sound level meter measurement (e.g. pressing PAUSE in the RTA screen also pauses the broad band LEQ, LcPEAK and MAX/MIN SPL measurements).



**X-Axis:** Logarithmic scale fixed to 20 Hz - 20kHz

**Y-Axis:** The scaling of the spectrum's Y-axis (sensitivity) can be adjusted manually.

- Select the displayed upper value of Y-axis and press the enter key.
- Use the up/down keys to scroll the displayed level along the Y-axis and the left/right keys zoom in/out the Y-axis, e.g. to alter the display resolution.



---

## SPL/RTA - Memory Functions

The SPL/RTA mode includes special memory features, such as in

### SPL/RTA - Sound Level Meter

- **LOGGING:** records the measured parameters to the internal device memory every time the log interval  $\Delta t$  has expired (in table form).

### SPL/RTA - Real Time Analyzer RTA

- **LOAD:** loads stored test results into the active AL1 display for detailed read out.
- **MATH:** completes mathematical averaging of various stored measurements selected from the memory.

## Logging

The Acoustilyzer can record various levels over time, e.g. for monitoring sound levels during an event for many hours, into the instrument memory. Every time the recording interval  $\Delta t$  is elapsed the results are stored and values marked with “\_dt” are reset afterwards. The logging may stop automatically after the preset measurement time has elapsed. The results can then be loaded to a PC and visualized as a level diagram using e.g. Microsoft Excel.

**Note: The stored results remain within the AL1 memory even in the event of a battery failure during the recording session.**

The following parameters are recorded during the logging.

LEQ	Leq over the whole measurement period. The measurement period is indicated and controlled by the measurement timer.
PreLEQ	Leq of the previous measurement timer period (in timer repeat mode only).
LEQ_dt	Short time LEQ of the actual log interval $\Delta t$ . LEQ_dt values may be combined to get the LEQ of any desired period:



$$LEQ = 10 \cdot \log \left( \frac{1}{N} \cdot \sum_{n=1}^N 10^{\frac{LEQ\_dt_n}{10}} \right)$$

MIN\_dt Minimum SPL value measured within the actual log interval  $\Delta t$ ; time weighted value (SLOW/FAST).

MAX\_dt Maximum SPL value measured within the actual log interval  $\Delta t$ ; time weighted value (SLOW/FAST).

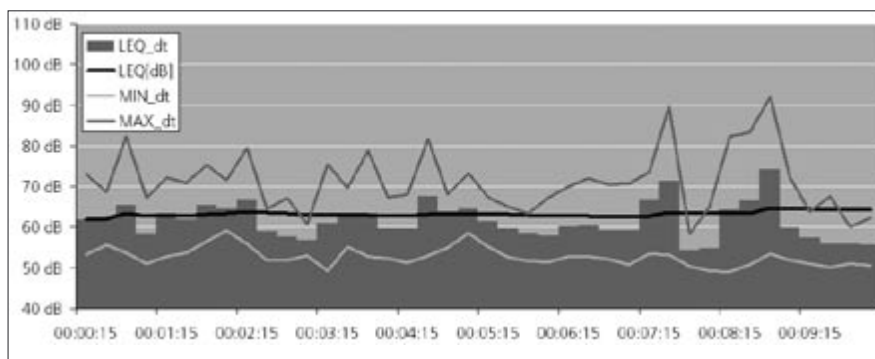

*Example of an SPL/LEQ log visualized with Microsoft Excel  
(without LcPEAK)*

LcPeak Maximum C weighted peak sound pressure level during the whole measurement period. The measurement period is indicated and controlled by the measurement timer.

LcPeak\_dt Maximum C weighted peak sound pressure level during the log interval  $\Delta t$ .

SPL\_Act Indicates the actual SPL level measured exactly at the end of the log interval. Please note that LEQ\_dt, MIN\_dt and MAX\_dt characterize an interval more accurate than this single SPL\_Act value.



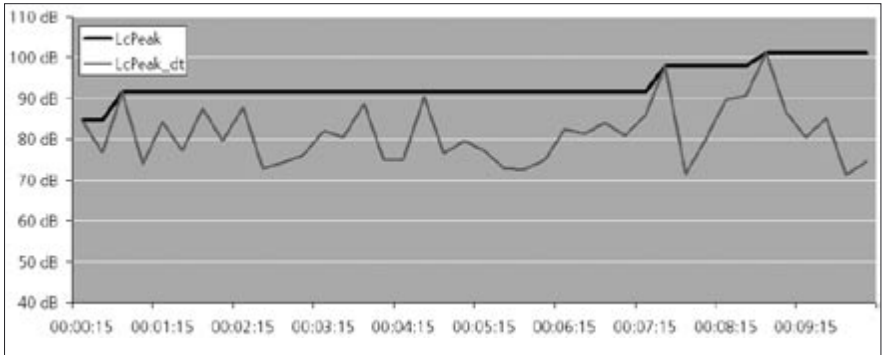

Example of an SPL/LEQ log visualized with Microsoft Excel  
(LcPEAK only)

OVER\_dt A “1” indicates an overload during the log interval  $\Delta t$  (so all values tend to be measured to low).

OVER\_Hold A “1” indicates an overload during the measurement period.

UNDER\_dt A “1” indicates an underload during the measurement period (so all values tend to be measured to high).



### Prepare Logging

Select LOGGING from the Memory Menu. This will bring up the Logger Setup Screen:



### Setting of recording time

The maximum recording time (END) of the sound pressure level logging depends on the remaining memory and the selected test interval ( $\Delta t$ ). The logger may record a maximum of about 580 points over a custom defined time. The test interval ( $\Delta t$ ) and the total logging time can be defined by the user in the format hh:mm:ss.

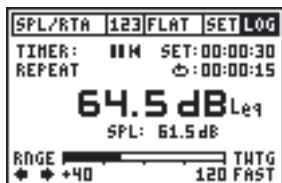

**Note:** During SPL/RTA logging the instrument may be switched to display the audio spectrum. This is possible without interrupting the ongoing log.



### Review logging records

The measurement data are saved under the file name “Axxx\_LOGSPL”, with xxx is a continuous running number. The detailed records can be read out by using the MiniLINK PC software.

## LOAD - Loading Test Results

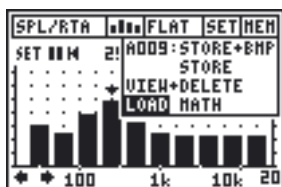

For details see the earlier chapter “Memory Menu”.

## MATH - Mathematical Averaging of Records

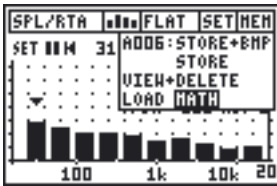

The MATH function allows to carry out averaging of stored test results.



### Application example:

- The available previously memorized data for averaging are displayed.
- Make your selection with the enter key → the square symbol in front of the selection is filled up.
- Select any number of test results for averaging.
- Press the ESC button (cursor jumps to OK) and confirm with enter.

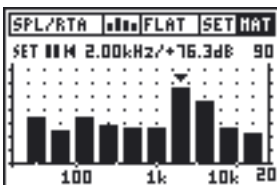

The averaged test result is displayed on the active AL1 screen and the abbreviation MAT is flashing in the status bar memory field.

The individual band levels can be read out, the Y-axis altered or even the LEQ or MIN/MAX test result shown.

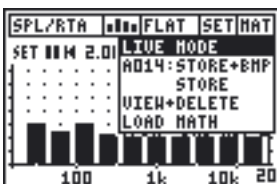

- Return back to the live mode by selecting LIVE MODE in the memory menu.



## Reverberation Time RT60

The Acoustilyzer supports reverberation time measurements in octave band resolution according to ISO3382 with auto trigger, auto ranging and averaging functionality.

### What is Reverberation Time RT60

Reverberation time RT60 is the time required for the sound pressure level to decrease 60 dB after the sound stimulus signal is stopped. Since ambient noise often defeats measurements of 60dB level decrease in practice, the RT60 results are based on T20 measurements. This requires only a 35 dB level decrease within each octave band. The RT60 test result is the extrapolation of the measured 20 dB decay.

### Test Signal

A gated pink noise signal is recommended to be used as test signal. Various test tracks with different on/off time are included on the accompanying AL1 Test CD. Alternatively the Minirator features a pink noise signal, which has to be physically interrupted (e.g. disconnect cable).

### a. Bargraph display

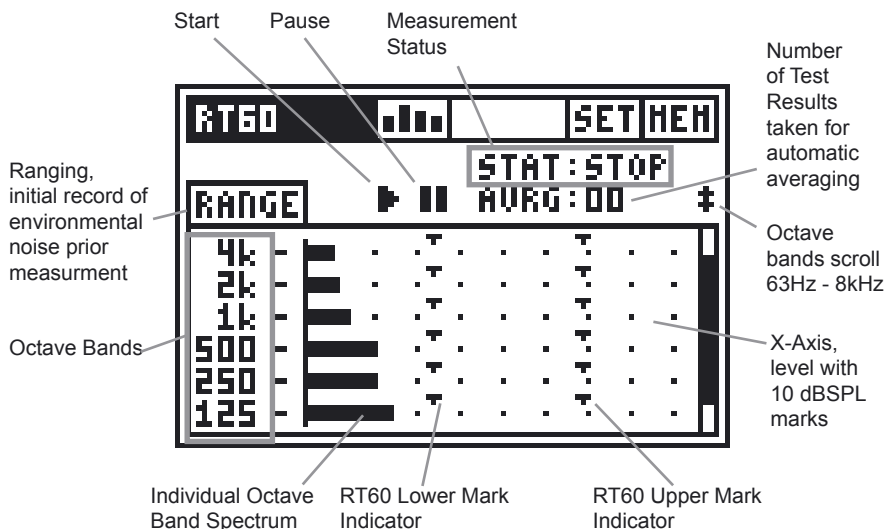

## b. How to measure

The room under test is injected with a pink noise signal through speakers. The sound source has to be active until balance between injected and absorbed acoustical energy has been reached. Then the source signal has to be stopped. The AL1 recognizes this interruption, triggers, the decay time is measured and the RT60 test result is automatically calculated.

Please follow the RT60 test instruction below:

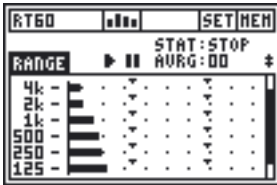

### Ranging

- Select RANGE and press the enter key to measure the actual sound pressure level in the room without test signal present.



- The SET RANGE field pops up. Confirm the automatic ranging by OK.

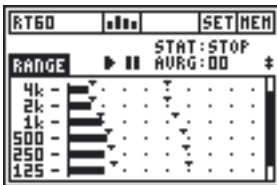

Now the RT60 upper mark indicators are set to the minimum pink noise level needed to successfully complete a measurement. The lower marks indicate the environmental noise without any test signal present.

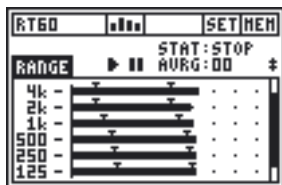

- Start the pink noise test signal with the appropriate on/off time according to the room under test.

**Note:** Use an initial low sound pressure level (to protect your ears against excessive sound level and hearing damages).

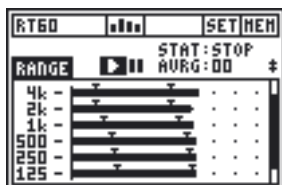

- Increase the test signal level until all individual octave band marks for the minimum test signal level are passed. As required an EQ can be used to push up individual band levels.

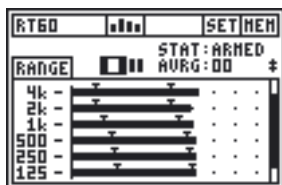

### Start RT60 measurement

- Select the START icon and press the enter key to initiate the reverberation time measurement.
- The status indication switches to ARMED.
- Complete several test cycles so an averaged test result is calculated.

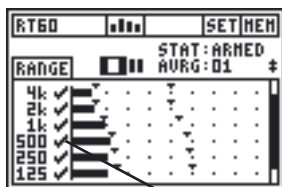

- The individual octave band sound pressure level increases above the upper marks.
- Upon the sound pressure level has fallen below the lower marks in each individual octave band the RT60 is calculated.
- Switch off the test signal.

Confirmation marks are displayed for successful octave band reverberation time measurements.

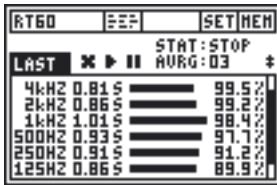

### Test result read out

The detailed RT60 test results in x.xx seconds are listed in the RT60 test result screen. Select the detailed test result read out screen by

- Using the screen menu
- Alternatively press the ESC and the left or right arrow key simultaneously.

**Note:** During the ongoing RT60 measurement the memory menu is not available.

### c. RT60 Test Result Read Out

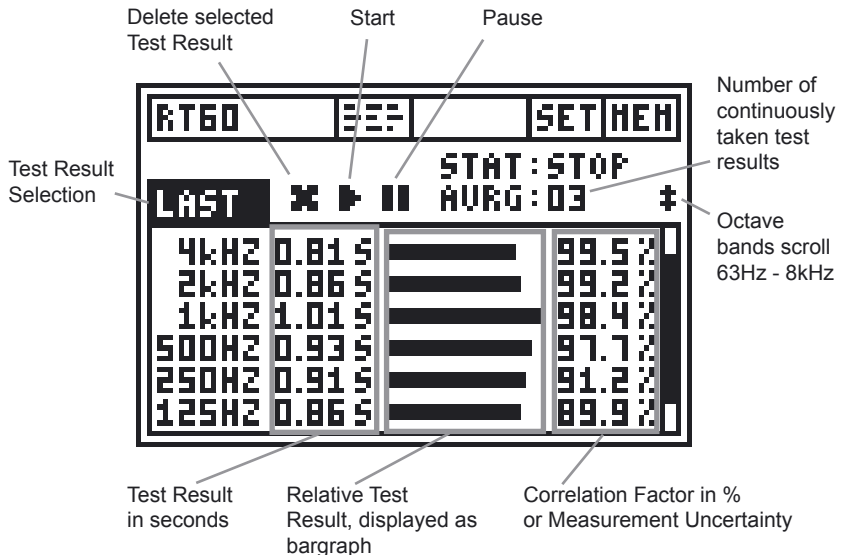

**Test Result Selection:** The RT60 measurement function enables consecutive reverberation time measurements within one test sequence. Automatically an averaged test result of all measurements is calculated.



Toggle with the left and right AL1 cursor keys through the individual test result cycles and you can find the following:

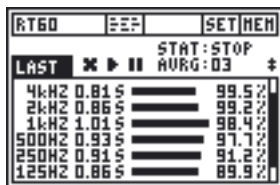

### Last test result

The test result of the last test cycle is displayed at selection LAST.

You can use the upper and lower AL1 cursor keys to display the 63 Hz or 8 kHz octave band test result additionally.

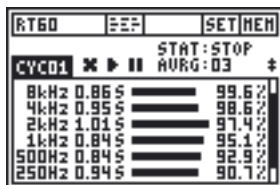

### Single test cycle results

The individual single test results are marked with CYC xx, whereby xx is a continuous running number.

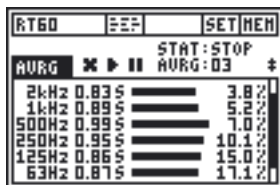

### Averaged test result

By selecting AVRG the averaged test results of all taken measurements are calculated and displayed. The correlation factor is replaced by the measurement uncertainty factor in %.

**Relative Test Result, displayed as bargraph:** To simplify the data read out the reverberation time is additionally displayed as bargraph, whereby the octave band with the longest measured reverberation time is shown with a bargraph of maximum length. The other octave band test results are displayed relative to the longest time.

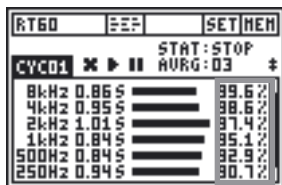

Correlation Factor in %

### Correlation Factor in %

(applicable for single test results)

This factor will be 100% for perfect linear sound pressure level decay after the source is switched off. Deviations from linearity result in lower correlation values. (typically 80 - 100% at reliable RT60 test results).



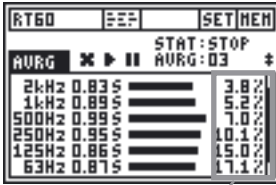

Uncertainty Factor in %

### Uncertainty Factor in %

(applicable for averaged test result)

Based on at least three individual test results, the uncertainty factors are calculated. This factor equals the statistical test result accuracy based on the randomly created pink noise test signal (typically 0 - 15% at reliable RT60 test results). Please see the standard ISO 3382 for details.

### Error Indications

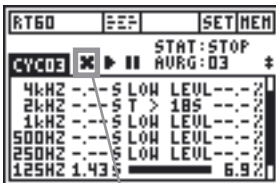

Delete single test results

Various error indications display non successful RT60 measurements, These can be deleted individually. Non-valid results are excluded from average calculations.

- **LOW LEVEL**

This is the abbreviation of “low test signal level” during the measurement

→ Increase the test signal level and verify that all levels are exceeding the upper marks

→ Use a corresponding RT60 test signal with longer on/off times, so the lower level mark can be reached

- **CORR<70%**

The correlation factor is lower than 70% indicating a unreliable measurement result.

- **T>18S**

The measured reverberation time exceeds the time limit of 18 seconds, e.g. caused by a not suitable ranging or environmental noise.

In this case repeat the ranging and start the measurement again.



## FFT Analysis

The Acoustilyzer includes an extremely fast, real-time Zoom FFT with resolutions up to 0.7Hz over the entire frequency range. The display shows 93 bins simultaneously.

The FFT measurement is the ideal tool for visualization of comb filters and narrow band effects. It allows a detailed investigation of the frequency response of audio systems.

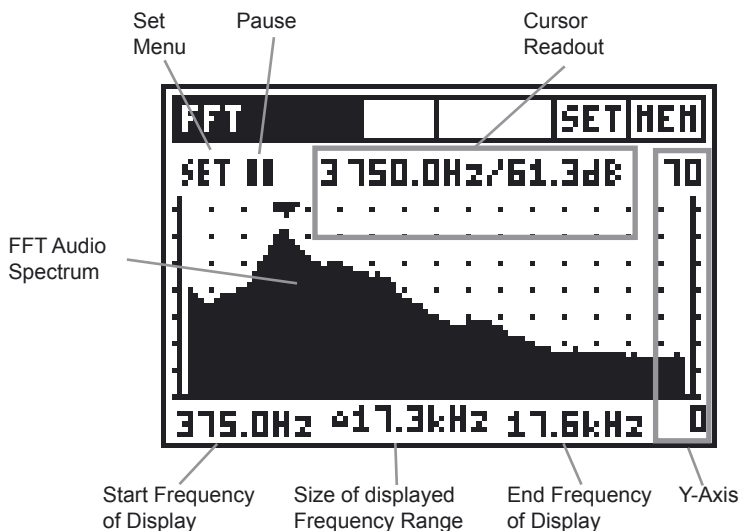

### Set Menu

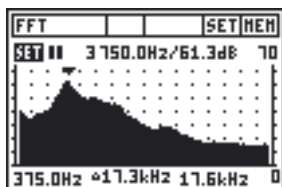

The SET menu allows the setting of measurement- and display options as follows:

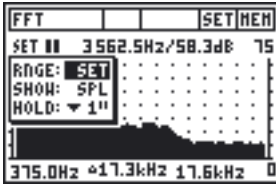

### Range - AL1 Input Ranging

The Acoustilyzer has different input ranges.

- The range is set automatically after entering the FFT mode
- Carry out the input ranging if any clipping or high noise occurs

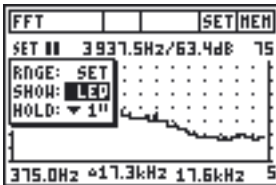

### SHOW - Test Result

Select the display of actual SPL or averaged sound pressure level (=LEQ). The LEQ measurement can be reset by executing the range setting or at the new selection of SHOW: LEQ.

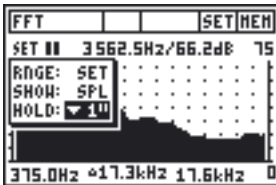

### HOLD - Cursor Hold

The cursor indicates the frequency of highest sound pressure level. For simple read out and traceability the cursor can remain for 1 - 9 seconds at the frequency with the highest level.

**Pause:** The FFT measurement may be frozen for a user defined time.

- Select the PAUSE symbol and press the enter key.
- The PAUSE symbol is flashing.
- Select the PAUSE symbol and press the enter key to continue the measurement.

**Cursor Readout:** Actual level result of the indicated frequency bin. The cursor readout displays the bin-frequency and the corresponding level. The cursor automatically jumps to the highest level in the spectrum. Alternatively the cursor readout may be controlled manually:

- Select the read out data field and press the enter key.
- A frame is flashing around the data readout.
- Move the cursor and read the corresponding test results.



**X-Axis:** Linear scale, showing from left to right the start frequency, the frequency range and the end frequency by 92 bins with zooming functionality.

**Y-Axis:** The scaling of the Y-axis can be adjusted manually.

- Select the displayed upper value of Y-axis and press the enter key.
- Use the up/down keys to scroll the displayed level along the Y-axis and the left/right keys zoom in/out the Y-axis, e.g. to alter the display resolution.

## How to measure:

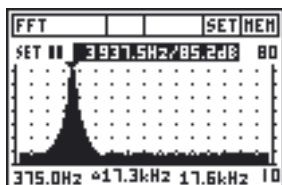

- Select the FFT function. The cursor read out shows the maximum level automatically.
- Select the cursor read out field and confirm with enter. A frame is flashing around the read out data.
- Read out other values using the left or right arrow keys.

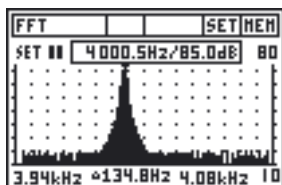

### Zoom in/out to cursor position

- Select the cursor read out field.
- Use the lower arrow key to zoom in out to a 0.7 Hz frequency resolution and the upper arrow key to zoom out.
- Move the x-axis by left/right key press.

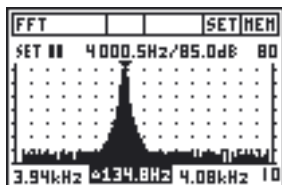

### Zoom in/out with quick X-axis shifting

- Select the x-axis frequency range field
- The zoom in/out functionality refers to the displayed center frequency.
- Use the left/right arrow key for quick left/right shifting of the x-axis.

## Application: FFT and White Noise

White noise is most often used as test signal when measuring the performance of acoustical systems. The FFT shows a flat spectrum with this input signal. Feeding white noise into an electro acoustic system and measuring the FFT using a measurement microphone shows the frequency response of the system with very high resolution.

Please note that the frequency response seen is most often a combination of two effects:

- a) The “real” frequency response of the electronics and speakers
- b) Interference effects (resulting in comb filtering)

With a high resolution FFT interference effects can easily be seen - while they are nearly impossible to notice on a 1/3 octave resolution RTA.

The Zoom FFT of the AL1 allows to “Zoom In” at any frequency point to a resolution of up to 0.73 Hz.

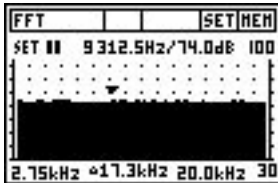

### White Noise and Zooming

The energy of “White Noise” is equally distributed over the linear frequency axis. Let’s assume we have a White Noise signal with a level of 0 dB measured using a bandwidth of 20 kHz.

What happens if we decrease the measurement bandwidth to 10 kHz?

→ We only measure one half of the energy – resulting in a level of -3 dB ( $10 \cdot \log_{10}(0.5)$ ).

↓  
4 x zoom →  
level reduces  
by 6 dB

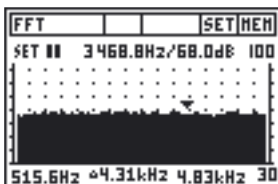

This is exactly what happens if we “Zoom In” using an FFT. Every time we “Zoom In” the measurement bandwidth is halved – resulting in a 3 dB lower level in every bin.



## Polarity Test

The polarity test function detects the correct cable and speaker polarity in combination with the Minirator MR1 polarity test signal. The Acoustilyzer provides the following test configurations:

### a. Speaker Polarity Test

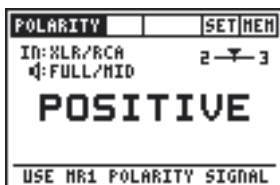

- Feed the speaker system with the polarity test signal of the Minirator.
- Adjust the level (at MR1 or amplifier) so the test signal is good to hear.

Acoustilyzer settings:

- IN:MIC (INT), using the internal mic of the Acoustilyzer AL1
- IN:XLR/RCA, using an external mic, such as the MiniSPL

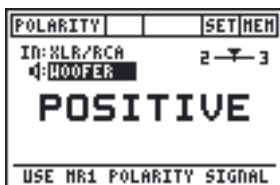

Choose the polarity test frequency range:

- FULL/MID, for wide band speaker tests
- WOOFER, for woofer tests

### Notes:

- Please note the polarity testing is a simplified measurement of a very complex signal phasing. Drivers, speakers and cross-overs cause severe phase shifts of the audio signal.
- The polarity of various speakers within the same cabinet can be different. This is not a problem nor caused by bad speaker design.
- Polarity testing is useful for checking the correct wiring of similar speaker systems.

## b. Cable Polarity Test

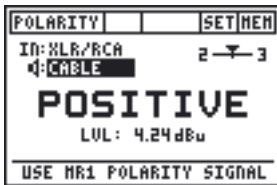

Use the polarity test signal of the Minirator to feed the cable under test. The Acoustilyzer analyzes the signal polarity at the other end of the cable.

Acoustilyzer settings:

- IN: XLR/RCA,
- Mode: Cable

**The following problems may be detected quickly and easily:**

- Wrong polarity, caused by wrong or defective wiring inside the cable
- Cable problems, unsymmetrical signals, displayed with the balance indicator, can help to detect various cable problems, such as

“**2UBAL-**” indicates an audio signal only on pin 2 of the symmetrical XLR cable → no signal at pin 3.

“**-UBAL3**” indicates an audio signal only on pin 3 of the symmetrical XLR cable → no signal at pin 2.

The balance indicator out of center leads to other cable problems as explained in detail in the NTI application note “Signal Balance” (available for download at the NTI website).

The level measurement is very useful for applications, such as testing of multicore cables (see the NTI website for application notes).



## Delay Time

The setting of the acoustics propagation delay time from speaker to speaker in e.g. churches or auditoriums, is required so the listening public notices the acoustics of the speaking person from his actual position and not from the side or rear speaker installed.

The Acoustilyzer measures the delay time of the acoustical speaker signal (**using the built-in microphone**) against the electrical line reference signal (connected at RCA or XLR input). As delay time test signal a designated chirp, provided on the AL1 Test CD, has to be used.

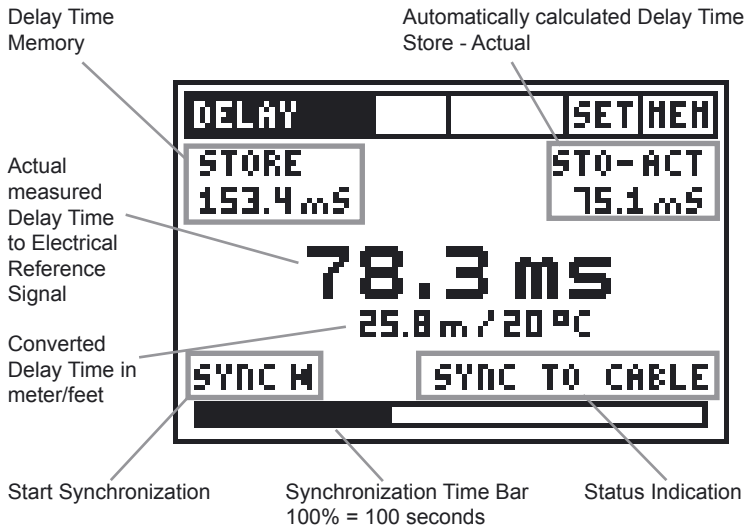

**Synchronization:** The automatic synchronization allows delay time measurements without any connected electrical reference signal for 100 seconds and displays the time remaining for the next required synchronization.

### Manual Synchronization:

Initiate a manual synchronization by selecting SYNC.



## How to measure

**Note:** Please de-activate any shock protection of the CD-player since this might cause incorrect test results!

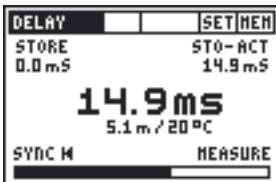
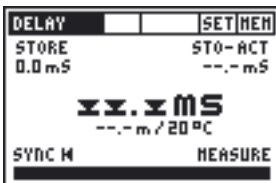
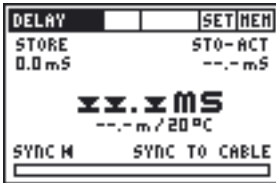

### Test preparations

- Switch on the acoustical delay time measurement signal, available on the AL1 Test CD.
- Connect the electrical signal, e.g. from the CD player, to the AL1 RCA or XLR input.
- Wait until the Acoustilyzer synchronizes to the incoming delay time test chirp and the synchronization time bar fills up to 100%.

The delay time measurement is conducted between the synchronized electrical input signal and the built-in microphone of the Acoustilyzer.

### Measure Reference Speaker

- Select a speaker as reference speaker, called speaker A, e.g. the speaker most in front of the delay line.
- Position yourself in the sound field of the next speaker under test, e.g. called speaker B, to measure the delay time compared to the reference speaker A.

**Note:** Do not position the Acoustilyzer too close to reflecting surfaces, such as walls or floors. The reflections may interfere any accurate measurements.

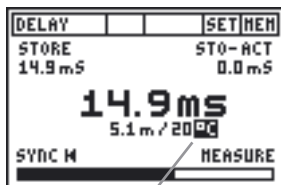

Change  
[m][°C] ↔ [feet][°F]

- Enable the test signal at the reference speaker A. All other speakers shall be switched off.
- The delay time of the acoustical signal in reference to the electrical input signal is displayed in milli-seconds. The distance results in meter/feet are displayed for easy verification of the test results. The readings are based on 330 m/s sound speed at 0°C / 32°F.
- Set the actual environment temperature, so the distance is displayed correctly.

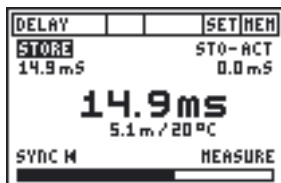

### Store reference

- Select STORE to memorize this test result as reference record for further delay time measurements.
- The stored reference delay time is shown in the delay time memory field.

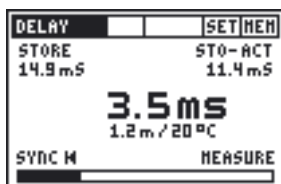

### Measure Propagation Time at Speaker

- Enable the test signal at the speaker B. All other speakers shall be switched off.
- The acoustical delay time of speaker B in reference to the electrical input signal is displayed as big test result.

### Automatic Time Difference Calculation

- The delay time difference is automatically calculated and shown in the upper small STO-ACT (stored - actual) field. The automatic difference calculation simplifies the verification of delay line arrangements, e.g. used in larger halls or auditoriums.

## Electrical Measurements - RMS/THD

The Acoustilyzer supports basic electrical measurement functions, such as

- Level RMS, reflects the absolute level of the line input signal.
- THD+N, Total Harmonic Distortion plus Noise, besides checking the linear purity of a sine signal - e.g. measuring the amount of harmonic distortions - this mode is particularly suited to get a quick idea whether unwanted interferences like hum are present.

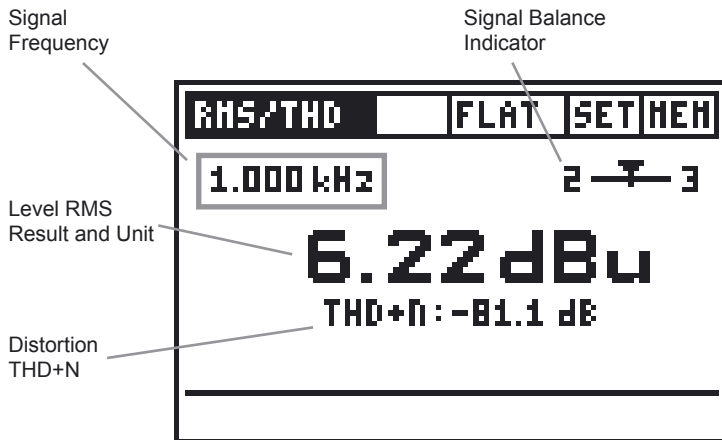

**Level RMS:** The units dBu, dBV, dB SPL and V are selectable.

**Distortion THD+N:** The distortion measurement, expressed in dB or in %, is carried out in the bandwidth 10 Hz - 20 kHz.



**Signal Balance** shows the matching deviation of the incoming signal between pin 2 and pin 3 in percent (%). The arrow position indicates the following:

- Arrow in center, the input signal is balanced.
- Arrow out of center, linear indication of a balancing problem, e.g. arrow moves left nearer to the number 2 shows the signal level on pin 2 is higher than on pin 3.
- Arrow at left or right end, the signal balance error is 33% or higher. 33% equals a difference in the signal level of 6 dB.
- 2UBAL-, indicates an audio signal only on pin 2 of the symmetrical XLR cable → no signal at pin 3.
- -UBAL3, indicates an audio signal only on pin 3 of the symmetrical XLR cable → no signal at pin 2.

**Notes:**

- **The Adapter -20dB shall be applied for balanced input levels higher than +20 dBu (see Accessories for details).**
- **The THD+N results are calculated using a measuring bandwidth of 10 Hz - 20 kHz.**

## Speech Intelligibility STI-PA (optional)

The speech intelligibility measurement STI-PA is an optional sales package for the Acoustilyzer AL1. Ask your local representative for purchasing details.

The STI-PA analyzer option allows reliable measurement of the speech transmission index within 15 seconds. Besides the single value STI or CIS test result, a detailed view of the modulation indices and individual band level results is provided. The STI-PA analyzer fulfills the latest 2003 IEC 60268-16 standard and is a TNO verified algorithm (dutch STI-PA research institute).

Find more information about speech intelligibility basics and the historical developments in the APPENDIX to this user manual.

### a. STI-PA Measurement Screen

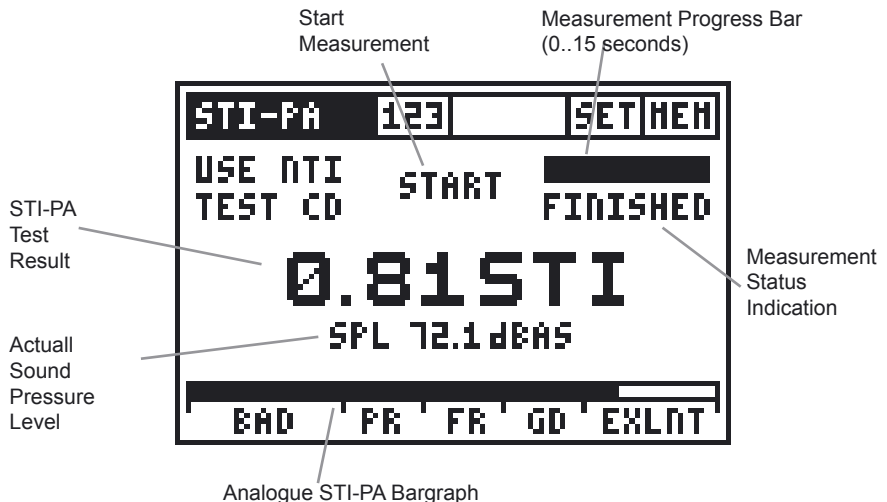

**STI-PA Test Result:** Single value speech transmission index result in STI (speech transmission index) or CIS (common intelligibility scale), whereby CIS is calculated as  $CIS = 1 + \log STI$ .

**Sound Pressure Level:** Shows actual SPL value in dBAS, including A-weighting and Slow time weighting.



## b. How to measure

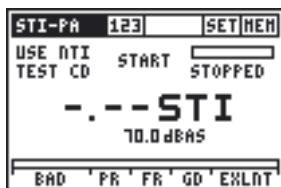

- Select the STI-PA function.
- Monitor the actual sound pressure level of your environment on the Acoustilyzer display.

### Preconditions:

- To avoid measurement failures the STI-PA test signal level should be min. 60 dB SPL.
- The STI-PA measurement should be carried out at emergency conditions (same sound pressure level and all components are activated).
- No impulsive noise events should occur during the 15 seconds measurement time.

**NOTE: Even intermediate noise may affect the STI-PA test result.**



### Signal Source:

The **NTI TalkBox** can simulate a human talker, enabling the measurement of the complete system including the microphone part (directivity, room characteristics, ...). Place the NTI TalkBox at the typical human speaker position.

A **CD Player** with the NTI CD “STI-PA V1.1” or higher can be used for electrical signal injection for system tests without the microphone part.

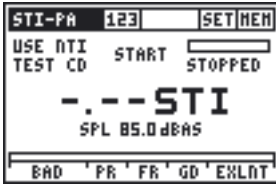

- Start the STI-PA test signal.
- Set the acoustical sound pressure level of the PA system according to the typical emergency condition requirements, e.g. 85 dBAS.

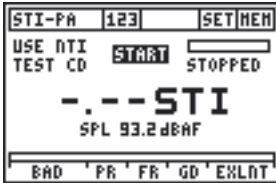

- Press START on the AL1 menu to initiate the measurement. Near the measurement microphone is no speaking or additional noise allowed during the measurement.

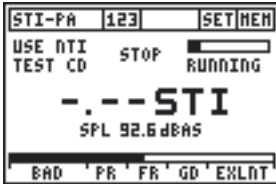

A STI-PA measurement takes 15 seconds. The elapsed test time is visible as blank part in the upper measurement progress bar.

The test result tendency is shown on the below STI-PA bargraph, marked with BAD, PR (poor), FR (fair), GD (good) and EXLT (excellent).

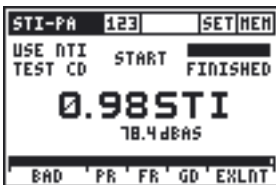

After the 15 seconds test cycle time the Measurement Status Indication switches to FINISHED and the final STI-PA test result is displayed.

On the bargraph below the quality of the speech intelligibility test result is displayed as

- BAD 0.00 - 0.30 STI
- PR (poor) 0.30 - 0.45 STI
- FR (fair) 0.45 - 0.60 STI
- GD (good) 0.60 - 0.75 STI
- EXLT (excellent) 0.75 - 1.00 STI





BAND	LEQ	MF1	MF2	
8000 Hz	64.3 dB	1.02	0.97	✓
4000 Hz	66.8 dB	1.09	0.96	✓
2000 Hz	68.4 dB	1.02	0.97	✓
1000 Hz	71.6 dB	0.97	1.04	✓
500 Hz	69.5 dB	1.00	0.89	✓
250 Hz	59.6 dB	0.99	0.98	✓
125 Hz	63.9 dB	1.21	0.64	✓

The detailed test result view of the modulation indices and individual band level results is provided on the second STI-PA measurement screen.

### c. Detailed Test Result Read Out

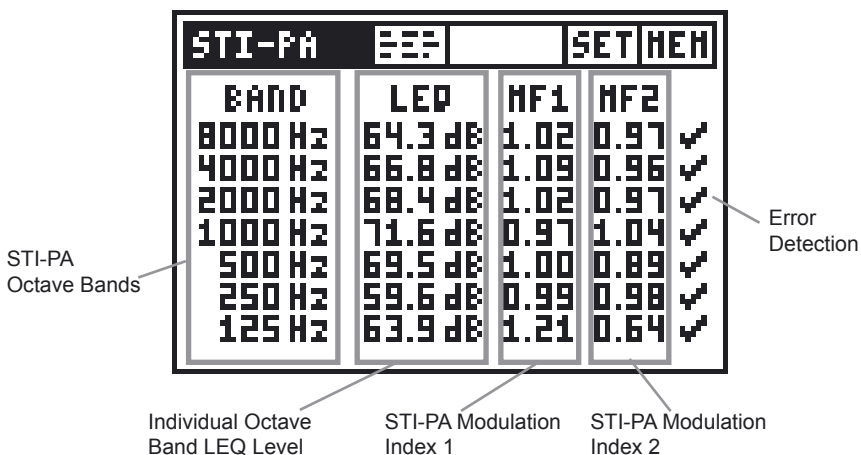

#### STI-PA Modulation Index 1 & 2:

For high speech intelligibility it is mandatory that the integrity of the transmitted voice signal modulations are preserved. Therefore STI-PA is based on measuring the MTF (Modulation Transfer Function). This function quantifies the degree to which the voice modulations are preserved in individual octave bands. STI-PA determines the MTF by analyzing all seven frequency bands, whereby each band is modulated with two frequencies, so resulting in the modulation index 1 and index 2





---

#### d. STI-PA Post Processing

Measuring the speech intelligibility with realistic environmental noise is often not applicable, e.g. in railway stations these measurements might not be carried out during peak hours with highest background noise level. In practice the STI-PA measurement will be much rather taken during the night as less persons getting disturbed by the played test signal.

For such special applications the STI-PA result taken at quiet conditions can be post-processed with the worst case noise spectrum, predicting the expected speech intelligibility during these worst case conditions.

The Microsoft Excel program “STI-PA\_PostProcessing.xlt” combines “noiseless” recorded STI-PA results with environmental noise spectra and predicts the resulting STI value. STI-PA and RTA results (1/3 and 1/1 octave) recorded and stored with the Acoustilyzer may be imported (use the MiniLINK Software to transfer these results from the AL1 to the PC).

“STI-PA\_PostProcessing.xlt” is available

- For download at “<http://www.nt-instruments.com/acoustilyzer>”
- On the CD “MiniLINK - PC Software”

**Note: At opening the post processing sheet all macros have to be activated.**



## e. STI-PA Error Detection

The Acoustilyzer STI-PA measurement function has a built in error detection which helps you identifying faulty measurements. The error detection checks the following parameters:

- Invalid modulation indices (MF1 or MF2 > 1.3)
- Irregularities during ongoing measurements

Both parameters depend on the amount of impulsive environmental noise. Impulsive environmental noise influences any STI-PA measurement and makes the values inaccurate.

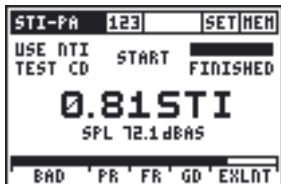

If the error detection finds any problem the common STI-PA test result is displayed interrupted with the flashing “?.??” question marks.

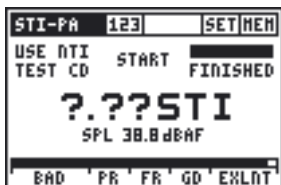

This error indication might be caused either by

- Missing test signal level
- Impulsive background noise events

```
STI-PA 123 SET MEN
BAND LEQ MF1 MF2
8000Hz 63.7dB 2.77 0.55
4000Hz 57.8dB 2.15 1.05
2000Hz 60.3dB 1.84 0.88
1000Hz 67.1dB 1.60 1.07
500Hz 69.5dB 1.00 0.89
250Hz 59.6dB 0.99 0.98
125Hz 63.9dB 1.21 0.64
BAD PR FR GD EXLAT
```

### Detailed test result screen

The octave bands detected with irregularities, are marked with a question mark (?).

### Recommendation

If the error detection finds any faults NTI recommends to repeat the measurement and to compare the STI test result with the previous ones.

---

## f. STI-PA Measurement Hints

1. Any background noise has to be sufficiently static during the measurement, e.g. pink noise fulfills this requirement.
2. Verify the environmental conditions prior testing. Complete STI-PA measurements without any test signal. The results shall be  $< 0.20$  STI.
3. Impulsive background noise during the measurement, such as speech, causes severe measurement errors. The STI-PA result is usually too high.
4. In case such impulsive noise can not be prevented, the measurements might be shifted e.g. to night time, and afterwards corrected with the averaged daily background noise, using external post processing.
5. Any CD-Players used to reproduce the STI-PA test signal have to be accurate as only limited time-shifts ( $\pm 200$  ppm) are allowed to ensure reliable STI-PA test results. Pitch control and shock protection shall be disabled. NTI recommends using professional players only.  
You may verify the time shift of your CD-Player with a 9 kHz test signal:
  - Generate a 9000 Hz sinus signal using the NTI Wavefilegenerator (available for download at ["www.nti-instruments.com/downloads"](http://www.nti-instruments.com/downloads)) and copy this on a CD
  - Insert this CD into the CD player and play the 9 kHz test signal
  - Connect the Acoustilyzer to the audio output directly and measure the signal frequency in the RMS/THD mode, the displayed frequency shall be in the range from 8998 to 9002 Hz (the last digit equals 111 ppm at 9 kHz)
6. The STI-PA test signals of other test system manufacturers may sound similar but are not compatible. Only the NTI STI-PA test signal CD V1.1 or higher shall be used in combination with the Acoustilyzer AL1.
7. STI-PA measurement of alarm systems shall be carried out at emergency conditions (same sound pressure level and all components are activated).
8. At locations undergoing different circumstances, e.g. public areas with few people or crowded areas, the worst case STI-PA results has to be measured.
9. Select typical locations, such as positioning the microphone at 1 - 1.2 meters above ground in sitting areas or 1.5 - 1.8 meters in standing areas (typical measurement positions are normally not directly in front of the speakers)



10. The person taking the measurements should be out of the acoustic field, so not affecting the measurement results. For this purpose the measurement microphone can be mounted on a mic stand and connected electrically (using an extension audio cable) to the AL1.
11. Low STI-PA readings can be caused by
  - Excessive sound reverberation, echoes or reflections
  - Poor speaker directivity or speaker coverage
  - Speaker power setting not in order (e.g. low signal-to-noise ratio)

Please see the NTI website or Appendix for further information.

## Calibration

In order to obtain correct measurement results the microphone sensitivity connected to the AL1 must be set and calibrated accordingly. The microphone sensitivity is set by default to the NTI MiniSPL measurement microphone factory adjustment 20mV/Pa. MiniSPL is the standard measurement microphone for the Acoustilyzer AL1. Together they are forming a comprehensive class 2 acoustics analyzer.

Alternatively to the MiniSPL the NTI M2010 class 1 frequency response microphone can be used for highly accurate class 1 measurements.

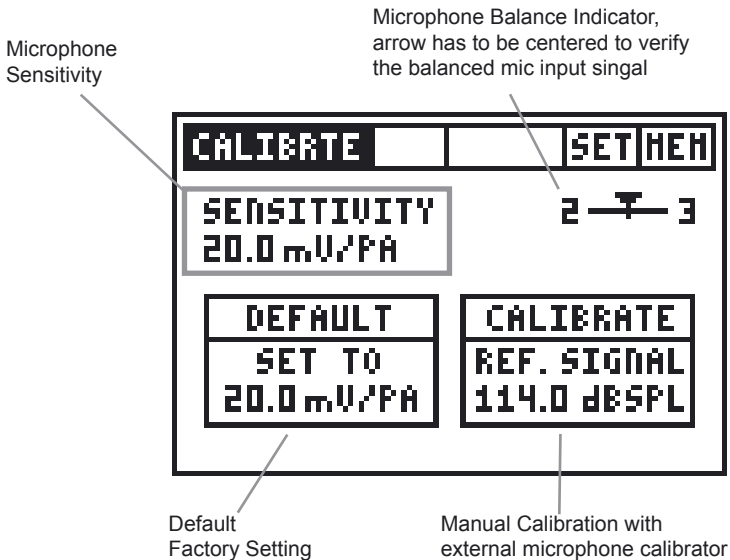

The following three calibration modes are available:

CALIBRATE		SET/HEH
SENSITIVITY 20.0 mV/PA		2 — 3
DEFAULT SET TO 20.0 mV/PA	CALIBRATE REF. SIGNAL 114.0 dB SPL	

### DEFAULT

All MiniSPL microphones are factory calibrated to a sensitivity of 20.0 mV/Pa. Reset to default setting by:

- Select DEFAULT
- Press the enter key



## CALIBRATE

The sensitivity may be adjusted with an external calibrator.

- Select the dB<sub>SPL</sub> value field (default = 114 dB<sub>SPL</sub>), press the enter key and adjust the sound pressure level as provided by your calibrator. Use up/down keys for 1.0 dB<sub>SPL</sub> steps and left/right keys for 0.1 dB<sub>SPL</sub> steps. The level range 80 - 140 dB<sub>SPL</sub> is supported.
- Confirm the setting with the enter key.
- Produce the specific reference signal with the calibrator onto the microphone.
- Press enter to execute the calibration, whilst the reference signal of the calibrator is still present.
- The frame WORKING ... followed by the frame CALIBRATION FINISHED! is shown centered on the calibration screen.
- The new sensitivity is shown in mV/Pa.
- Enter the SPL/RTA mode and check the calibration by applying the reference signal again to the attached microphone. The sound pressure level of the calibrator shall be shown to confirm the calibration is carried out in good order.



In case of calibration problems various error indications may be displayed to inform the user about problems, such as caused by

- to low or to high input level.
- the calculated sensitivity is out of the range 2 - 80 mV/Pa.



CALIBRATE	SET MEN
SENSITIVITY 2 $\nabla$ 3	
20.0 mV/Pa	
DEFAULT	CALIBRATE
SET TO	REF. SIGNAL
20.0 mV/Pa	114.0 dB SPL

## Manual sensitivity setting

- Select the sensitivity value field,
- Press enter and adjust the sensitivity using the up/down keys for 1.0 mV/Pa steps and left/right keys for 0.1 mV/Pa steps. The setting range 2 - 80 mV/Pa is supported.
- Press enter to confirm the setting.



## 5. MiniLINK PC Software

The MiniLINK PC software enables the transfer of stored measurements from the Acoustilyzer AL1 to the PC. Additionally the online data logging from the AL1 directly to the PC is supported

### Installation

- a. Switch on the PC with Windows operating system (MiniLINK supports Windows 98 SE, 2000, ME and XP)
- b. Insert the enclosed MiniLINK CD into the CD drive.
- c. The MiniLINK software installation starts automatically. Follow the instructions on the screen.

If the CD auto-start is disabled on the PC, follow the instructions below:

- Click on “Start → Run” at the windows taskbar.
- Type “d:\setup” (assuming “d” is the letter of the CD drive)
- Confirm with “ok”

After completing the software installation, the MiniLINK CD shall remain in the CD drive for the next step.

**Note: If the MiniLINK PC software has been previously installed on the PC, the old version will automatically be removed. After removing you need to run the setup program again to install the new software.**

- d. Use the attached USB cable to connect the test instrument to the PC. Windows recognizes the new hardware component automatically and starts the hardware installation assistant.

Follow the instructions of the installation assistant. Please select the CD drive with the inserted MiniLINK CD as source for the USB driver when asked by the installation assistant.

In case the warning messages “Digital signature not found”, “Do not install driver”, “not certified driver” or similar come up: Don’t listen to Microsoft, listen to us and continue with the installation.



## Start the MiniLINK PC Software

After the successful driver installation, the MiniLINK software can be started.

- To start the software follow the windows path “Start → Program → MiniLINK”.
- The analyzer switches on automatically and the following screen is displayed on the monitor:

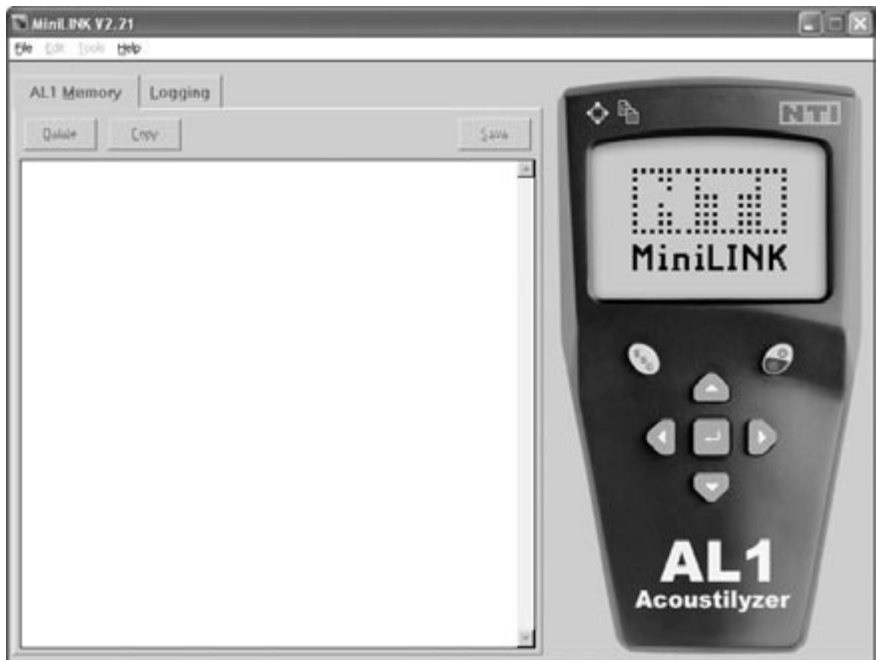

The test instrument is powered by the USB interface and therefore switches on by itself. During the operation with the connected USB interface the **batteries should not be removed** from the device.



## Free Registration of your Test Instrument

The Acoustilyzer includes additional “bonus features“, enabled after the registration of the test instrument at the NTI web site.

Overview of available bonus features:

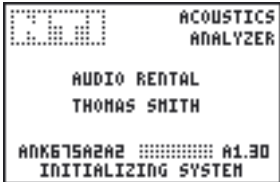
Instrument	Function	Display
AL1	Customized start-up screen	

### Online registration:

After the startup, the MiniLINK software automatically suggests the registration of non-registered connected instruments. The test instrument needs to be connected to the PC. Proceed with the automatic registration or alternatively select the MiniLINK menu “Help → Register“.

### Offline registration:

Register your device at “<http://registration.nti-audio.com/Registration.php>”. Key in your details and the serial number of the device. Read out the instrument serial number from your device by starting the instrument and keeping any button pressed. The start up screen remains displayed. The serial number starts with three letters (such as ANK675A0A2).

After successfully registering your device, you will receive an e-mail with your registration key within a few minutes. Please insert this key in the MiniLINK menu “Help → Register“. The test instrument needs to be connected to the PC.



## Read Out of Stored Test Results

The analyzer memory is automatically transferred to the PC and visualized with small screenshots at the MiniLINK memory window.

**Note:** The MiniLINK memory window remains empty when no test results are stored within the instrument. Otherwise, use the PC mouse to click onto the “AL1 Memory“ tab to initiate and update the data memory window.

The test instrument display at the PC is synchronized to the actual LCD screen display of the connected audio analyzer. The title bar shows the serial number and firmware version of the test instrument.

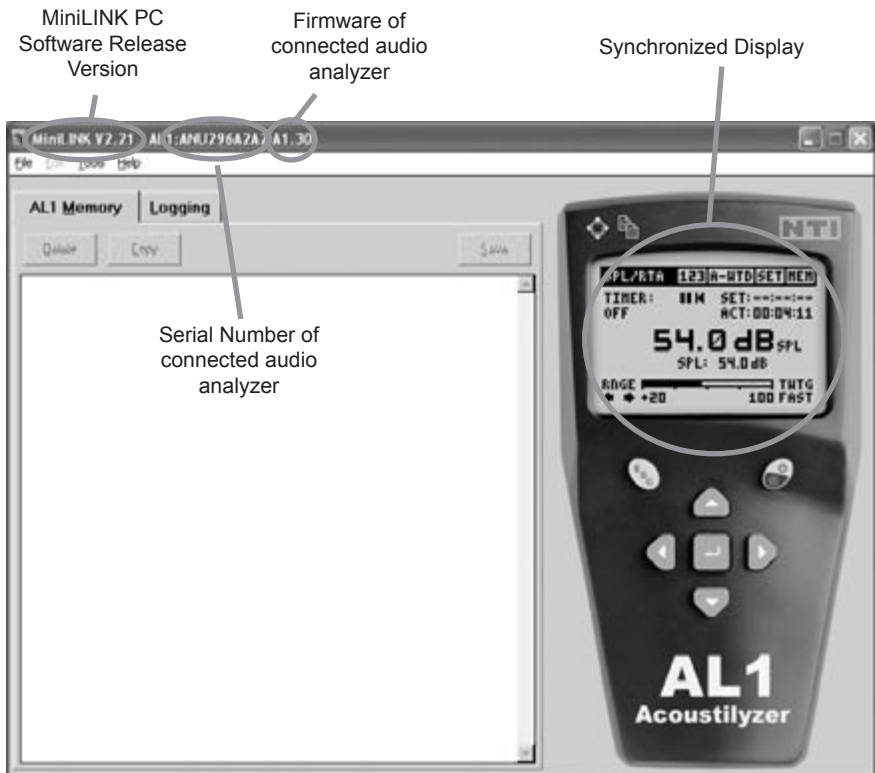



## Visualizing the Test Results

All stored screenshots are shown in the MiniLINK tab “AL1 Memory”.

Stored screenshot incl. numerical results

Stored data without screenshot

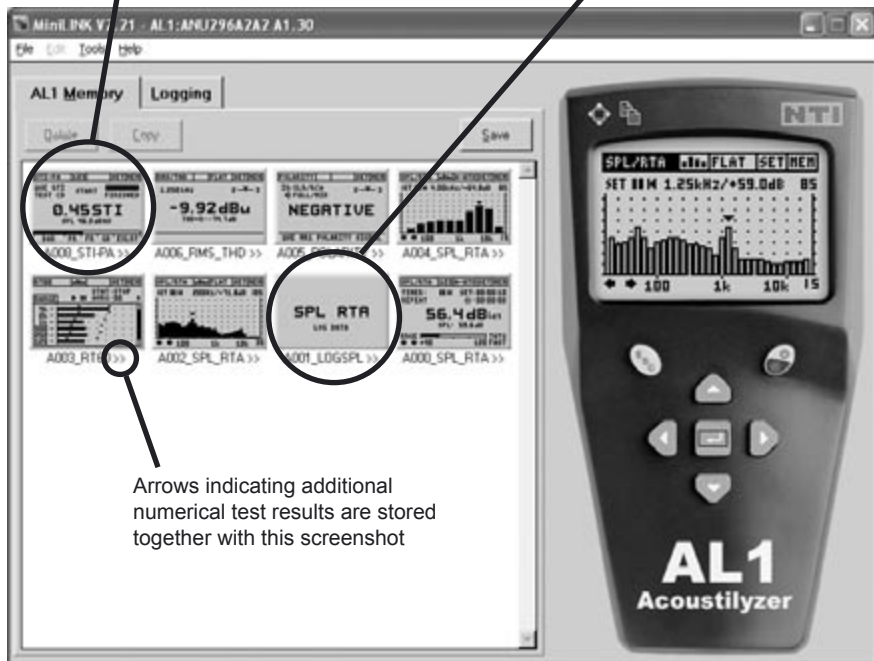

Arrows indicating additional numerical test results are stored together with this screenshot

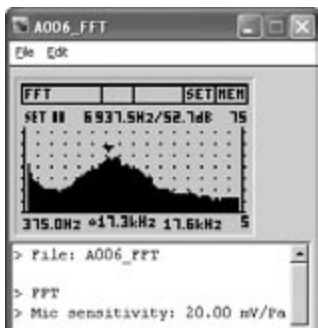

### Big view of screenshots

A double click on the screenshot will enlarge this screenshot. In this mode the menu allows printing, saving or copying of the screenshot or the numerical test results.

Any available numeric table is listed below the big view screenshot.

## Copying of Test Results and Screenshots

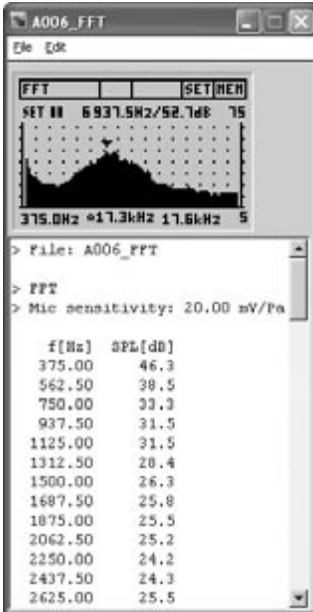

The displayed screenshots can directly be copied into reports for documentation.

- Select the menu “Edit → Copy Bitmap” to choose the graphics or select the menu “Edit → Copy Text” to choose the numerical measurement data
- Insert the clipboard into the reporting document with “Ctrl + V”, such as Excel, ...

Alternatively import the stored “\*.txt” file, including the numerical measurement data, e.g. to Microsoft Excel by using the Excel import assistant.



## Example: Display of SPL/RTA test results

The SPL/RTA sound pressure level measurement provides the following test results:

- Test configuration
- Time, relative to logging start
- All relevant sound level parameters (please refer to section “SPL/RTA - Memory Functions” for details).

```
> File: A003_LOGSPL
> SPL_RTa_full_band
> Timer mode: off
> Timer set: --:--:--
> Time weight: fast
> Selected filter: A-Weighting acc. IEC 61672
> Range: 20 dB - 100 dB
> Mic sensitivity: 20.00 mV/Pa
```

Time	ActTimer	LEQ[dB]	LEQ_dt	MIN_dt	MAX_dt	LePeak	LePeak_dt	SPL_Act	OVER_dt	OVER_Hold	UNDER_dt
00:00:15	00:00:15	61.9	61.9	53.2	73.1	84.6	84.6	61.0	0	0	0
00:00:30	00:00:30	62.0	62.2	55.7	68.8	84.6	76.7	61.4	0	0	0
00:00:45	00:00:45	63.5	65.5	53.8	82.4	91.5	91.5	58.4	0	0	0
00:01:00	00:01:00	62.7	58.4	51.0	67.1	91.5	73.9	55.4	0	0	0
00:01:15	00:01:15	62.8	63.3	52.8	72.3	91.5	84.3	65.5	0	0	0
00:01:30	00:01:30	62.7	61.9	53.8	71.0	91.5	77.2	63.1	0	0	0
00:01:45	00:01:45	63.2	65.3	56.5	75.4	91.5	87.6	63.5	0	0	0
00:02:00	00:02:00	63.4	64.5	59.2	71.5	91.5	79.6	65.3	0	0	0

## Save Test Results & Screenshots

The displayed screenshots can be saved as bitmap files (\*.bmp) to the PC's hard drive. Any available numeric test data will be saved as text files (\*.txt). The file names are the first six (6) digits of the device serial number and the screenshots name.

For example the screenshot "A011\_RT60" recorded e.g. with an Acoustilyzer S/N ANK675 is saved as

- "ANK675\_A011\_RT60.bmp"
- "ANK675\_A011\_RT60.txt"

This enables to store various test results of more audio analyzers on the same PC. Save the stored test results as follows:

- Select the screenshots to be saved in the memory field.
- Press the SAVE button or select in the menu "File → SAVE".
- The following menu below will be displayed. Select the configuration and press SAVE.

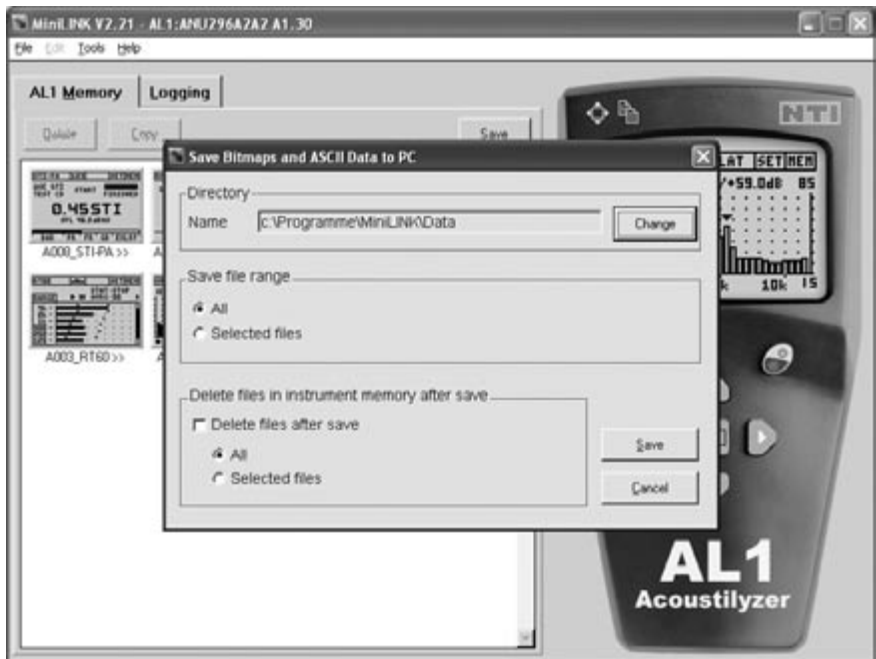



When saving the screenshots to the PC the same memorized values can be deleted at the test instrument automatically. Just select in the above displayed menu “Delete files in instrument memory after save” to empty the test instrument memory simultaneously.

## **Delete Test Results of Analyzer Memory**

The memorized test results in the test instrument can be deleted as follows:

- Directly in the test instrument memory overview
- Select the screenshot in the MiniLINK memory screen and press DEL on the PC keyboard or using the delete function of the MiniLINK memory menu
- Selecting the delete function when saving the screenshots/test results to the PC

## **Test Result Logging at the PC**

MiniLINK also allows the continuous logging of the Acoustilyzer test results online in customer defined time intervals. This test data is saved into the default log file software directly. At the end of the logging process, press the “SAVE” button to save and the data are saved under the file name e.g. “ANK675\_PcLog\_Level SPL”.

The logging function is ideally suited for long term monitoring or troubleshooting, e.g. in repair or broadcast applications.





icon for direct copying of present screenshot

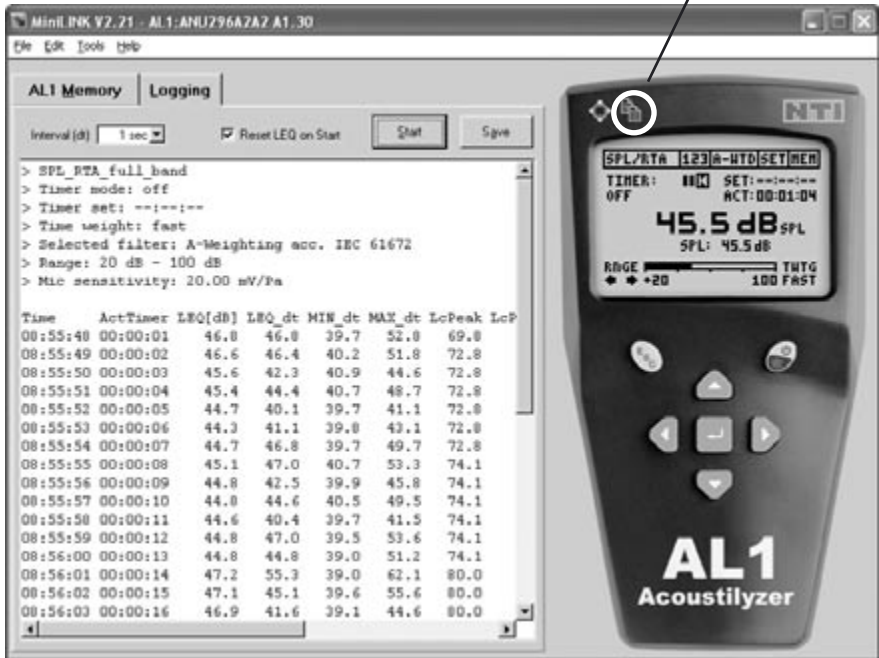

To log online results, please:

- Select the requested measurement function at the test instrument
- Select the "Logging" screen in the MiniLINK PC Software menu
- Select the required log time interval
- Press the "START" button to start the test result logging
- Press the "STOP" button to end the logging process
- Press the "SAVE" button to save the record to file

Additionally the present screenshot displayed on the MiniLINK PC software can be directly copied to file by pressing the marked icon with the mouse button. Paste the screenshot into any files by pressing "CTRL + V".



## Remote Test Instrument Control with the PC

MiniLINK supports the remote control of the analyzer from a PC. Just click on the displayed test instrument and all keys can be operated with the below listed keys at the PC keyboard or using the mouse.

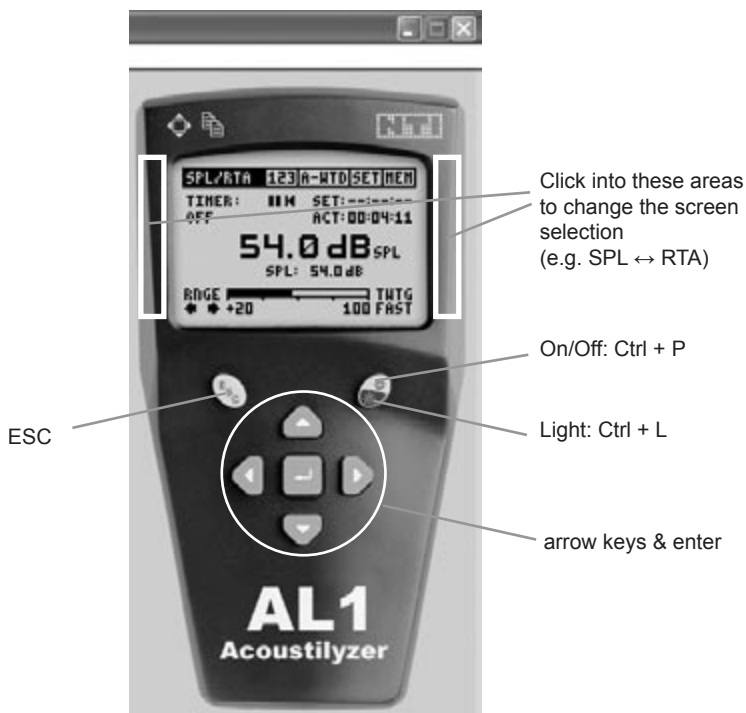

“Shift ←” or “shift →” or the above indicated areas allow to change the screen selection of the enabled measurement function.



## MiniLINK Tools

The MiniLINK PC software includes many useful tools as follows:

- LCD Fullscreen
- Update Firmware
- Crossgrade Firmware
- StartUp Screen

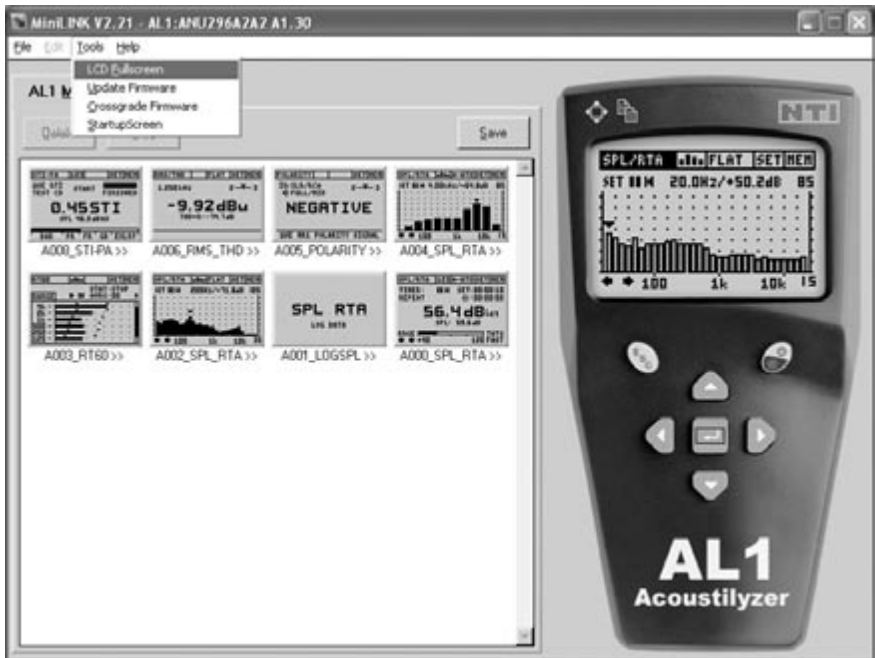



## LCD Fullscreen

The actual test instrument display can be shown on the PC monitor in a full screen mode.

### To enter the full screen mode:

- Select the menu “Tools → FullScreen” at MiniLINK or click onto the  symbol.

### To exit the full screen mode:

- Press the “Q” button on the PC keyboard or simply click into the screen with your PC mouse.

icon for large screen display



## Firmware Update

NTI provides free updates of the test instrument firmware and the MiniLINK PC software at the NTI website “[www.nti-instruments.com](http://www.nti-instruments.com)”.

To check out any available online updates, follow these instructions:

- Connect your PC to the web & start the MiniLINK PC software
- Connect the instrument with the USB cable to the PC
- Select the menu “Help → Look for Updates” at MiniLINK
- Follow the download instructions

Alternatively you can check for any new firmware and software releases at the web site “<http://registration.nti-audio.com/VersionCheck.php>”.

- Select the menu “Tools → Update Firmware” at MiniLINK

Select the new firmware version in the displayed screen below:

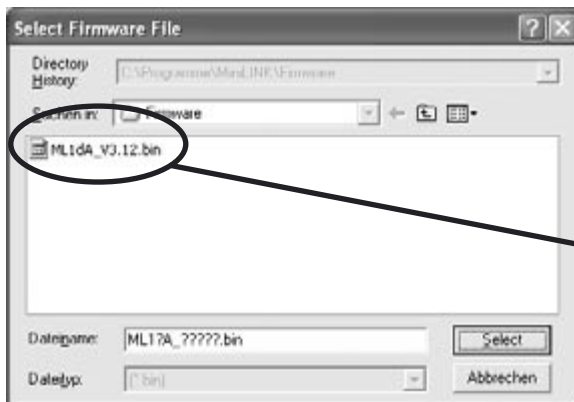

for Minilyzer ML1:  
ML1dA\_V3.xx.bin

for Acoustilyzer:  
AL1dA\_A1.xx.bin

applicable firmware for  
the connected device

After confirming the selected device firmware, the test instrument firmware is updated automatically.

**Note:** In case of any problems during the firmware upgrade, such as power failure, etc., the upgrade procedure can be repeated anytime.



## Firmware Crossgrade

The Acoustilyzer AL1 and the Minilyzer are based on the same hardware platform with different specific firmware installed. The available crossgrade packages allow to install the ML1 firmware into the AL1 or to install the AL1 firmware into the ML1.

- Select the menu “Tools → Crossgrade Firmware” at MiniLINK

Select the displayed firmware version in the screen below:

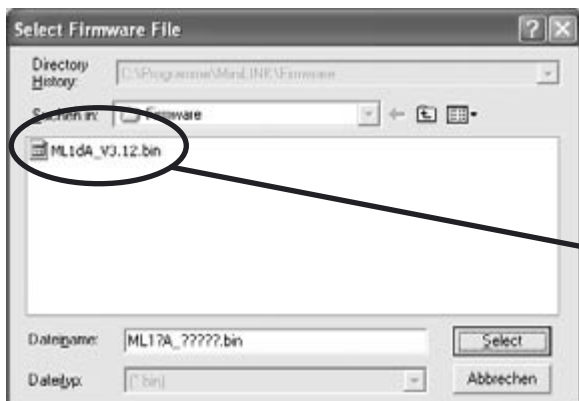

for Minilyzer ML1:  
AL1dA\_A1.xx.bin

for Acoustilyzer:  
ML1dA\_V3.xx.bin

applicable firmware for  
the connected device

After confirming the selected device firmware, the crossgrade firmware is installed automatically within several seconds. The instrument displays UPDATING FIRMWARE.

**Note:** The firmware crossgrade deletes the internal device memory.

## Customizing the Startup Screen

The MiniLINK PC software supports the transfer of customized start-up screens to the test instruments. The personally defined start-up screen will be displayed instead of the factory logo every time the test instrument is switched on.

- Start the MiniLINK PC software
- Connect the instrument with the USB cable to the PC
- Select the menu “Tools → StartupScreen“ at MiniLINK

The following screen is displayed on the monitor:

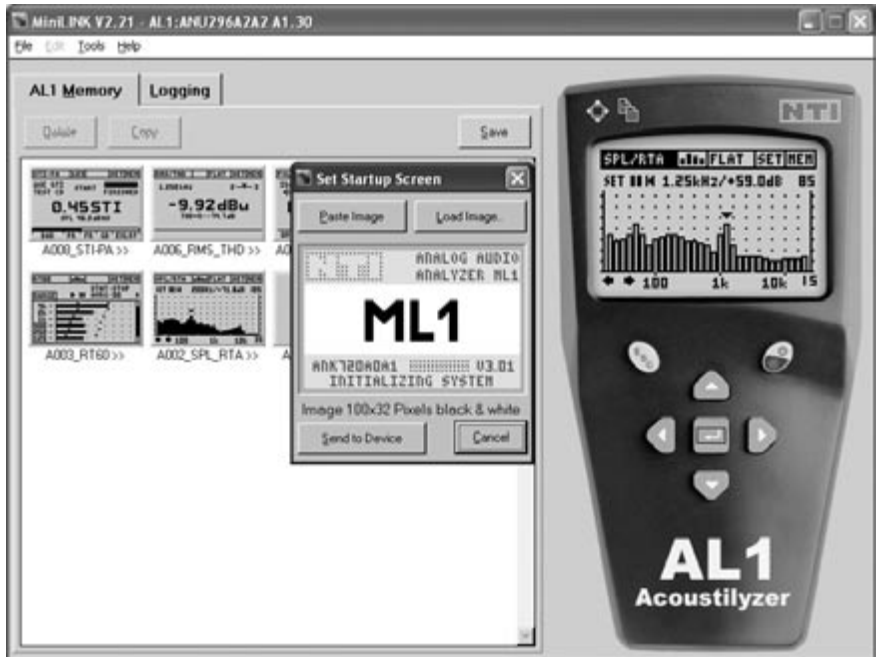

The panel “Set Startup Screen” displays a sample default factory startup screen. The white center area (100 x 32 pixels) can be customized by the user. The remaining top & bottom gray area is fixed and cannot be altered.



Guideline to define the new start-up screen:

- Use a pre-defined picture. The MiniLINK PC software will convert it to a 100x32 pixels black & white picture automatically. The following file types can be used as start-up screens: \*.pcx;\*.bmp;\*.dic;\*.rle;\*.ico;\*.wmf.
- Alternatively create a new start-up screen yourself using any picture / paint programs, such as “Microsoft Paint”. Set the file size to 100x32 pixel and insert any text or graphics for the start-up screen. Save the file as “\*.bmp\* format.
- Press the button “Load Image” to select the file containing the new start up screen.
- The start-up screen preview is displayed on the PC monitor.
- Press the button “Send to Device” to transfer the file to the device
- The audio analyzer is switching off and on automatically, so you can check out the new start-up screen by yourself immediately.

Sample start-up screens:

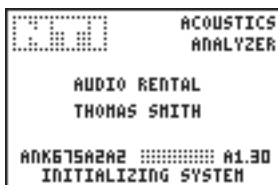





## Activate Options

The activate options menu is required for

- Activation of AL1 functionalities on your Minilyzer ML1 or the ML1 functionalities on your Acoustilyzer with the crossgrade package
- Activation of STI-PA measurement functionalities on the instrument

To activate one of the above functionalities

- Select the menu “Help → Activate Options“ at MiniLINK
- The following menu will be displayed

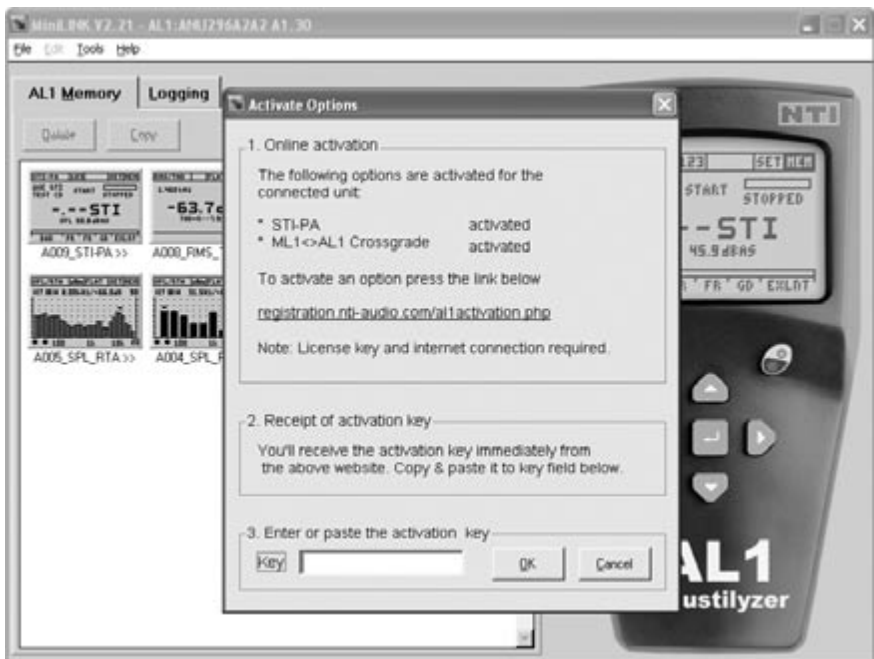

Follow the online activation instructions. Additionally detailed instructions are enclosed with the license number within the individual product package.



## 6. Troubleshooting

### Numeric data import of “\*.txt” files to Excel

Problem:

The numbers are recognized as text only at the import of numeric test results to e.g. Microsoft Excel, so you cannot create tables or use the data for further calculations.

Solution:

The MiniLINK data files use the “.” as decimal separator. Therefore please set the decimal separator to “.” at the import procedure of these numeric test results into e.g. Microsoft Excel.

Alternatively you can use copy → paste in the big view mode, select the menu “Edit → Copy Text” and paste the data into an open Excel document.

### Factory Reset

To reset the instrument back to factory settings proceed as follows:

- Switch the unit off
- Press the ESC button and the On button at the same time for a few seconds
- The start-up screens shows up, reading in the bottom line “LOADING DEFAULT SETUP”

The instrument is now reset to factory conditions.

## 7. Accessories

### MiniSPL

The MiniSPL is the perfect accessory for acoustical measurements. Together with the Acoustilyzer AL1 a comprehensive integrating sound level meter is formed.

The MiniSPL is a self contained omni directional 1/2" measuring microphone with built in impedance converter, pre-amplifier and power supply. It is battery powered and the XLR-output is balanced. The MiniSPL is classified as class 2 in accordance with IEC 61672 and is factory adjusted to a sensitivity of 20 mV/Pa.



### STI-PA Measurement Option

The STI-PA analyzer option allows the reliable measurement of the speech transmission index according to the latest IEC standards within 15 sec. Besides the single value STI or CIS test result, a detailed view of the modulation indices and individual band level results is provided.



### NTI TalkBox

The TalkBox is the missing link for the complete evaluation of speech intelligibility in emergency life & safety announcement systems, from the talker's microphone to the listener's ear. The NTI TalkBox presents the standardized voice-like acoustical signal emission simulating a human talker according to IEC 60268-16, combined with a TNO certified speech intelligibility signal at standardized levels.





### ML1 - AL1 Crossgrade

The ML1 - AL1 Crossgrade package enables to load the Minitizer firmware onto your instrument, providing test functionalities, such as

- vu-PPM
- Balance
- THD 2nd - 5th harmonics
- Scope
- Frequency Sweep
- Time Sweep
- Induction Loop Mode



### Adapter -20dB

The Adapter -20dB may be applied for balanced input levels higher than +20 dBu. This passive adapter extends the balanced input range of your Minitizer/Acoustilyzer up to +40 dBu. The adapter is supplied with pin1-fuse for safe operation in combination with the USB interface MiniLINK.



### Pouch

The soft pouch protects your Ministrument against shocks, dust and water. With its convenient belt-clip you can keep your Ministrument close to you even when you need both hands for other tasks.

Now available with a MiniSPL microphone holder, offering a space to store your mic.



### Minstruments System Case

Store your valuable Minstruments test system consisting of the Minirator MR1, the Minitizer ML1 or Acoustilyzer AL1 and the MiniSPL adequately in the compact system case which gives you extra space for cables, connectors and other accessories you may wish to bring along when you are 'out in the fields' checking audio systems.





---

## 8. Technical Specification

### Measurements

- Sound Pressure Level
- Real Time Analyzer
- Zoom FFT
- Reverberation Time
- Delay Time
- Level RMS
- Distortion THD+N
- Frequency
- Polarity Test
- Speech Intelligibility STI-PA (optional)

### Sound Pressure Level

- SPL, Leq, Lc peak, Lmin, Lmax acc. IEC 61672
- Timer for single and repeated measurements
- Dynamic range (using MiniSPL): 30 - 130 dB<sub>SPL</sub><sub>A</sub>
- Filters: Flat, A, C, X-Curve<sup>-1</sup>, RLB (Broadcast Loudness)
- Logging of SPL/RTA results into AL1 memory
- Wideband- and RTA values simultaneously available

### Real Time Analyzer

- 1/3 or full octave band resolution, class 0 filters
- SPL, LEQ and Max-Min display per band

### Zoom FFT

- Real-time Zoom FFT with 50% overlapping, 93 Bins
- Frequency Range: 10 Hz - 20 kHz
- Resolution: 187.5 Hz to 0.73 Hz

### Reverberation Time

- Octave band resolution, 63 Hz - 8 kHz, based on T20 results, according to ISO3382.
- Automatic averaging with individual result readout and storage
- Source signal: Gated pink noise (CD included)

### Delay Time

- Propagation delay between electrical and acoustical signal input using built-in mic. Resolution < 0.1ms, max time: 1 s
- Dedicated test signal: NTI chirp (CD included)



## Electrical

- Level RMS, THD+N, Frequency, Polarity

## STI-PA (Option)

- Single value STI and CIS test result. Modulation indices and individual band level results accessible. Error indicator.
- Fulfills the IEC 60268-16 release 2003 standard (including amplitude weighting)
- TNO verified algorithm

## PC Interface

- MiniLINK USB interface with PC software and interface cable included

## Frequency

- Range 10 Hz to 20 kHz
- Resolution 4 digits
- Accuracy  $< \pm 0.1 \%$

## Level

- Units dBu, dBV,  $V_{\text{RMS}}$
- Resolution 3 digits (dB-scale) or 4 digits (V-scale)
- Accuracy  $\pm 0.5 \%$  @ 1 kHz
- Bandwidth 20 Hz to 20 kHz
- Flatness  $\pm 0.1$  dB

## THD+N (Total Harmonic Distortion + Noise)

- Measurement Bandwidth 10 Hz to 20 kHz
- Resolution 3 digits (dB-scale) or 4 digits (%-scale)
- Residual THD+N  
balanced  $< -85$  dB @  $-10$  dBu to  $+20$  dBu  
unbalanced  $< -74$  dB @  $0$  dBu to  $+14$  dBu

## Polarity Test (with MR1 test signal)

Positive / Negative detection through internal microphone or XLR RCA connector. Checks polarity of midrange-speakers, woofers, sub-woofers and cables. Down to 10 dB S/N ratio of input signal.

## Filters

- Flat
- A-weighting
- C-weighting
- X-Curve<sup>-1</sup>
- Highpass 400 Hz
- Highpass 19 kHz



---

### Input Connectors

- XLR balanced, RCA unbalanced

### Input Impedance

- 40 kOhm balanced, 20 kOhm unbalanced

### Input RMS ( upper measurement limit )

- balanced +20 dBu (7.75 V<sub>RMS</sub>)
- unbalanced +14 dBu (3.8 V<sub>RMS</sub>)
- for input levels > 20 dBu (balanced) the Adapter -20 dB is available as accessory

### Max. DC Input

- $\pm 50 V_{DC}$

### Residual Noise

- < 12  $\mu$ V, XLR-input shorted

### Internal Microphone (for Polarity and Delay measurement only)

- Omni directional

### Monitor Output

- Jack 3.5 mm (1/8"), suitable for all common headsets

**Display** Graphic LCD 64 x 100 pixel, with backlight

### Batteries

- 3x AA batteries (alkaline)
- Typical battery lifetime > 16 hrs

### Dimensions (L x W x H)

- 163 x 86 x 42 mm (6.4" x 3.38" x 1.63")

### Weight

- 300 g (10.5 oz) incl. batteries

### Temperature

- 0° to +45° C (32° to 113° F)

### Humidity

< 90 % R.H., non condensing



## 9. Appendix: Introduction to STI-PA

### **Application:**

In case of emergency, public address systems in buildings like airports, railway stations, shopping centers or concert halls have to (clearly) inform persons in danger about escape information and directions. However if such announcements are misunderstood due to poor system quality, tragic consequences may result. Therefore, it is essential to design, install and verify sound reinforcement systems properly for intelligibility. In addition, a variety of other applications such as legal and medical applications may require intelligibility verification.

### **Standard:**

The IEC 60849 standard (national standards - see table) requires the verification of electro acoustic sound systems for emergency purposes to ascertain a minimum level of speech intelligibility in case of an emergency under realistic circumstances. Thereby, speech intelligibility from a regulatory view is not a subjective measurement, but can be verified with several, more or less complex methods that have been standardized in IEC 60268-16.

### **National standards:**

- IEC 60849 Sound systems for emergency purposes (also VDE 0828 part 1 and DIN-EN, BS-EN, SN-EN, OEVE-EN, ...)
- NFPA 72 National Fire Alarm Code 2002 (2002 edition, section 7.4.1.4)
- BS 5839-8 Fire detection and alarm systems for buildings. Code of practice for the design, installation and servicing of voice alarm systems

### **Subjective Testing Methods:**

Although frequency response, distortion or loudness all are important to intelligibility, conventional measurements of these same parameters together only marginally relate to intelligibility. When added issues such as directionality of drivers and the environment are taken into consideration, the question then is how well a spoken message can be understood at different locations.

One approach is to let a trained human speaker read a number of existing or synthetic words, whereas a representative number of listeners



individually write down what they believe of having understood. The statistical analysis of these notes results in a value representing the percentage of the listeners who have understood the messages correctly.

Important procedures according to this method are PB-words, CVC or SRT (Speech Reception Threshold). However, conducting such tests is rather costly, and in some hazardous locations, even impossible. Therefore, these methods are mainly used to verify technical principles during development.

### Technical Methods:

Already back in 1940, Bell Laboratories started to develop measurement technologies to determine the speech intelligibility. Nowadays, highly developed algorithms as SII (Speech Intelligibility Index) and various forms of the STI (Speech Transmission Index) allow measuring speech intelligibility. These techniques take care of many parameters which are important for intelligibility such as:

- Speech level
- Background noise level
- Reflections
- Reverberation
- Psycho acoustic effects (masking effects)

Measurement techniques use synthesized test signals that don't sound like speech, but which have many common characteristics to real speech signals. The averaged frequency response, as well as low frequency modulation, is based on human speech. Since the speech of men's and women's voices sound different, some measurement techniques use separate male and female test signals: Speech intelligibility measurements acquire and evaluate the signals in a manner characteristic of the way human speech is altered before reaching the ears of a listener. Extensive investigations have shown the relationship between the alteration of speech characteristics and the resulting speech intelligibility. These findings are incorporated into the speech intelligibility meter that is able to display the intelligibility result as a single number between 0 (unintelligible) and 1 (excellent intelligibility).





## STI, RASTI or STI-PA

STI, RASTI or STI-PA are the most established methods for measuring speech intelligibility. All three of them basically apply the same principle, whereby RASTI and STI-PA are a simplified version of STI. This article explains the principles behind these methods.

### Speech Model:

First of all, measuring the speech intelligibility requires a model for speech signals. For instance, speech may be described as superposition of various phoneme frequencies that are modulated (i.e. of which the amplitude is varied).

#### Frequency Spectrum:

The frequency analysis of a male voice over a certain period results in a typical characteristic as shown in Figure 1.

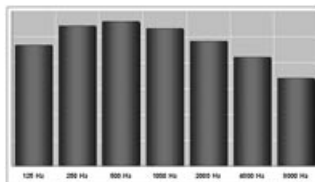

Fig. 1: Averaged octave band spectrum of a male speaker.

#### Time Modulations:

Within each frequency band, the signal level varies, i.e. it is “modulated” by the speaker. Figure 2 shows the envelope of a speech signal in the 250 Hz band, whereby the shape of the envelope is given by the speech contents.

By analyzing the spectra of envelope sequences it can be shown that a speaker modulates the individual frequency bands in the range from 0.2 to 12.5 Hz.

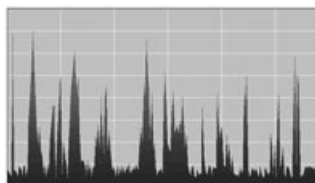

Fig. 2: Envelope of a speech signal (250 Hz band).

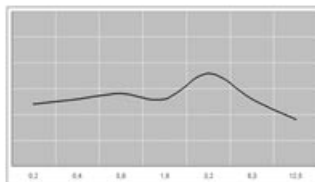
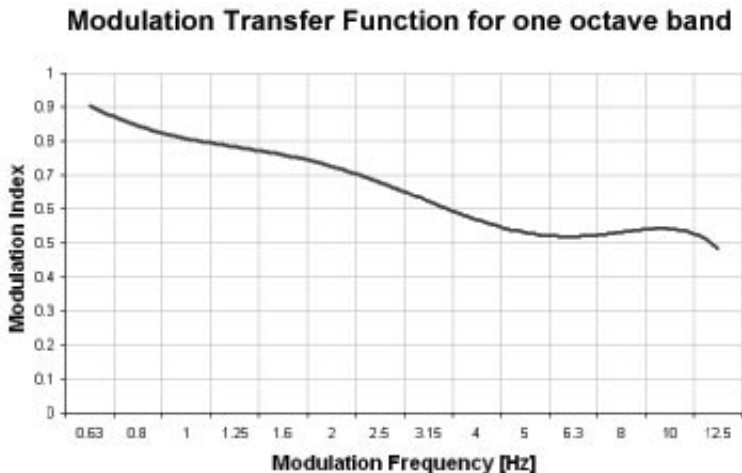

Fig. 3: frequency spectrum of the envelope of a speech signal (250 Hz band).

## Modulation Transfer Function (MTF)

For a high speech intelligibility it is mandatory that the integrity of the modulations of the transmitted voice signal be preserved. Therefore, the three core intelligibility measurement methods, STI, RASTI und STI-PA are based on measuring the MTF (Modulation Transfer Function). This function quantifies the degree to which the voice modulations are preserved in the individual frequency bands.

The envelope shown in Figure 3 is divided into 1/3rd octave band frequencies, thus resulting in 14 frequency bands between 0.63 and 12.5 Hz. The modulation transfer function determines for each of the 7 voice bands (refer to Figure 1) how well the modulations are preserved.



Based on the MTF results as well as further parameters such as the sound pressure level, hearing threshold, frequency response or psycho acoustic effects (masking effects) it becomes possible to reliably determine the speech intelligibility. The corresponding calculations are based on extensive and profound evaluations and comparisons with subjective methods that are optimized continuously. Measuring the complete MTF – as required for STI – can become rather complex. For instance,  $14 * 7 = 98$  individual measurements must be executed, thus resulting in a total acquisition duration of 15 minutes. Therefore, different approaches have been developed to reduce the test period and to enable speech intelligibility measurements with portable instruments.



## STI - Speech Transmission Index

The STI result is based on the complete set of 98 measurements. Since this approach requires a rather long test period, it is less frequently applied in practice. However, STI represents the most detailed method to measure the speech intelligibility and is mostly used if alternative approaches do not provide reliable results due to unfavorable environmental conditions.

In practice, the STI result is preferably calculated out of the impulse response (MLSA) that has been acquired e.g. with a PC-based system. This approach is much quicker, but requires a lot of experience and especially a linear behavior of the setup, i.e. there must be no non-linear processing or conditions, including compressors or limiters, which is a rather rare situation.

Octave Bands	Modulation Frequencies													
	0.63 Hz	0.8 Hz	1 Hz	1.25 Hz	1.6 Hz	2 Hz	2.5 Hz	3.15 Hz	4 Hz	5 Hz	6.3 Hz	8 Hz	10 Hz	12.5 Hz
125 Hz	✓	✓	✓	✓	✓	✓	✓	✓	✓	✓	✓	✓	✓	✓
250 Hz	✓	✓	✓	✓	✓	✓	✓	✓	✓	✓	✓	✓	✓	✓
500 Hz	✓	✓	✓	✓	✓	✓	✓	✓	✓	✓	✓	✓	✓	✓
1 kHz	✓	✓	✓	✓	✓	✓	✓	✓	✓	✓	✓	✓	✓	✓
2 kHz	✓	✓	✓	✓	✓	✓	✓	✓	✓	✓	✓	✓	✓	✓
4 kHz	✓	✓	✓	✓	✓	✓	✓	✓	✓	✓	✓	✓	✓	✓
8 kHz	✓	✓	✓	✓	✓	✓	✓	✓	✓	✓	✓	✓	✓	✓

## RASTI - Room Acoustics Speech Transmission Index

RASTI acquires only few segments of a complete MTF, which at first glance obviously represents an extreme simplification of STI. Therefore, tight use restrictions must be met to acquire reliable speech intelligibility results with RASTI. Furthermore, the RASTI result does not consider significant and practical auxiliary parameters such as the frequency response, echoes or frequency-dependant reverberation times.

For a RASTI measurement, only two simultaneously generated frequency bands are considered, i.e. the 500 Hz and the 2 kHz band which then are modulated with four and five frequencies respectively.

The practical application of RASTI is mainly restricted to acquisitions between two persons. However, RASTI used to be the only method to measure the speech intelligibility with a portable instrument for a long time

Octave Bands	Modulation Frequencies (approx.)													
	0.63 Hz	0.8 Hz	1 Hz	1.25 Hz	1.6 Hz	2 Hz	2.5 Hz	3.15 Hz	4 Hz	5 Hz	6.3 Hz	8 Hz	10 Hz	12.5 Hz
125 Hz														
250 Hz														
500 Hz			✓						✓					
1 kHz														
2 kHz	✓			✓						✓				
4 kHz													✓	
8 kHz														

## STI-PA - Speech Transmission Index for Public Address Systems

A rising awareness for security issues, new technological means and the shortcomings of RASTI triggered the speaker manufacturer Bose and the research institute TNO to develop a new method for speech intelligibility measurements of PA installations. The result of these efforts is STI-PA, which allows quick and accurate tests with portable instruments.

Like RASTI, STI-PA applies a simplified procedure to calculate the MTF. But STI-PA determines the MTF by analyzing all seven frequency bands, whereby each band is modulated with two frequencies.

Supposing that no severe impulsive background noise is present and that no massive non-linear distortions occur, STI-PA provides results as accurate as STI. If however impulsive background noise is present during the normal system operation hours, it is usually possible to mitigate the effects by also acquiring a measurement at a more favorable time e.g. under slightly different conditions in the area, or during the night time - and to calculate an unbiased overall measurement by using the results of both test cycles.

NTI STI-PA measurement table:

Octave Bands	Modulation Frequencies (approx.)													
	0.63 Hz	0.8 Hz	1 Hz	1.25 Hz	1.6 Hz	2 Hz	2.5 Hz	3.15 Hz	4 Hz	5 Hz	6.3 Hz	8 Hz	10 Hz	12.5 Hz
125 Hz														
250 Hz														
500 Hz														
1 kHz														
2 kHz														
4 kHz														
8 kHz														

Portable STI-PA analyzers, e.g. NTI's Acoustilyzer, are able to evaluate speech intelligibility within 15 seconds per position and are thus well suited for wide-area measurements and high productivity.

Read more on the web site "<http://www.nt-instruments.com/acoustilyzer>".





**[www.minstruments.com](http://www.minstruments.com)**