

RACK MOUNTING

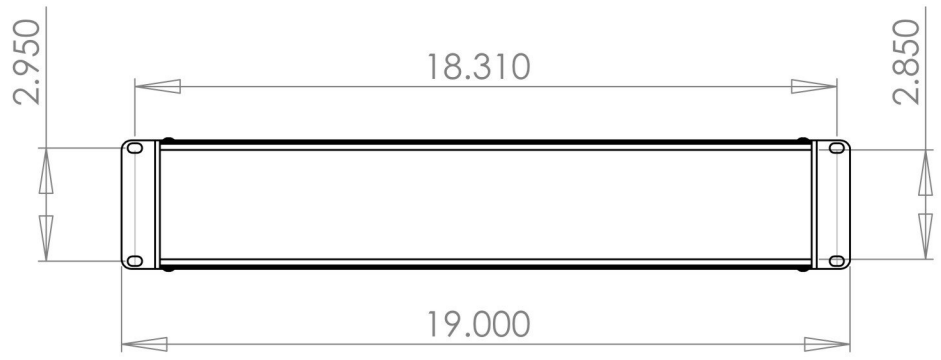
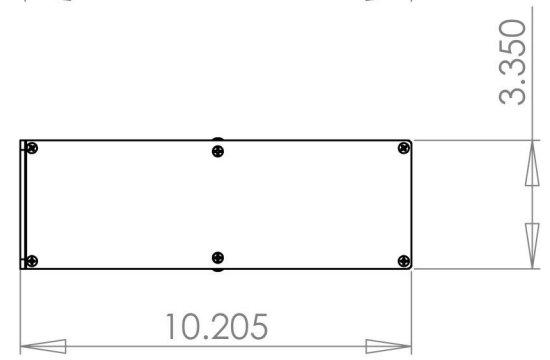
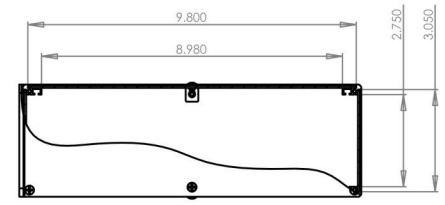
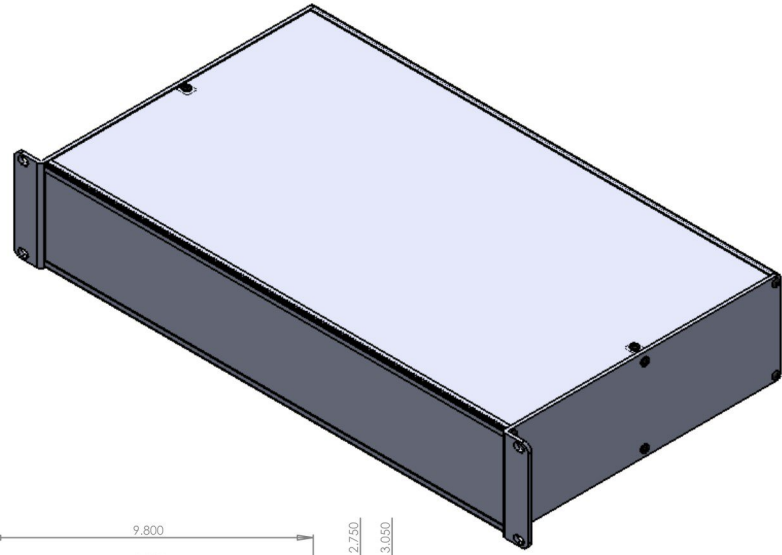
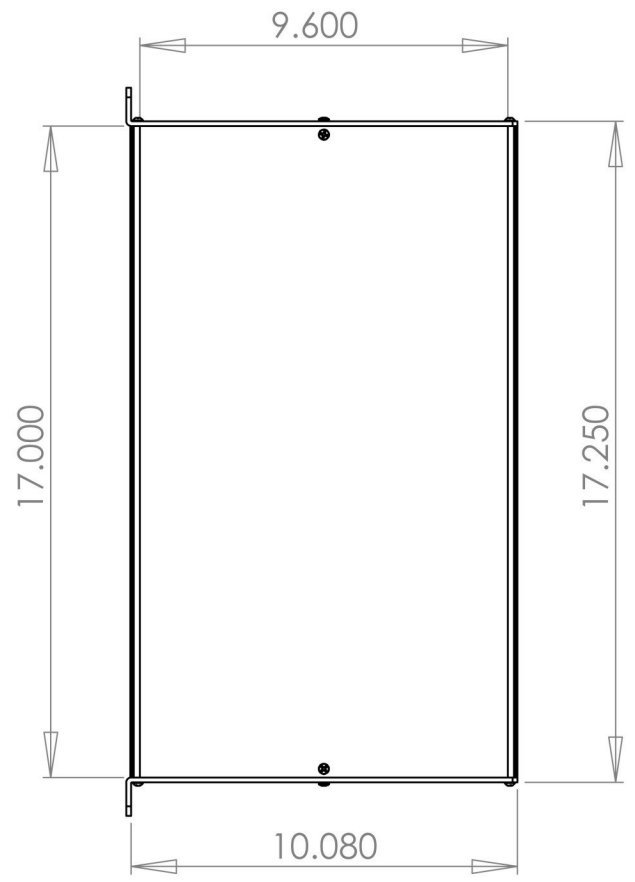

CONNECTRONICS
www.TecNec.com

PART NUMBER **CTX-2RU10**
19 x 10 x 3.5 Aluminum Enclosure.
Black Anodized

Unless otherwise specified, dimensions are in inches. Information in this drawing is provided for reference only.