

RACK MOUNTING

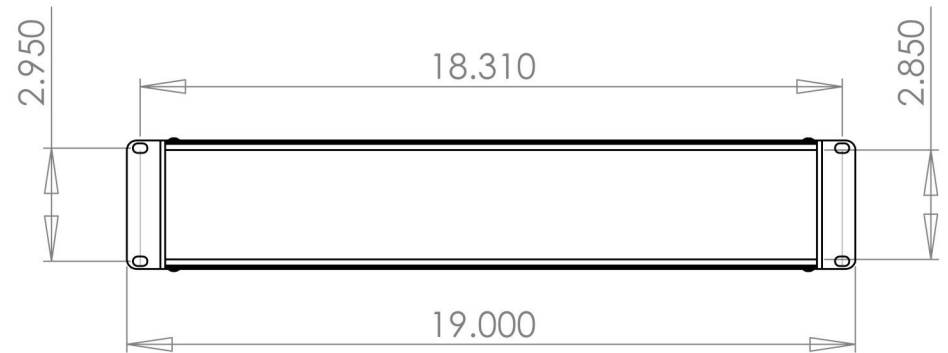
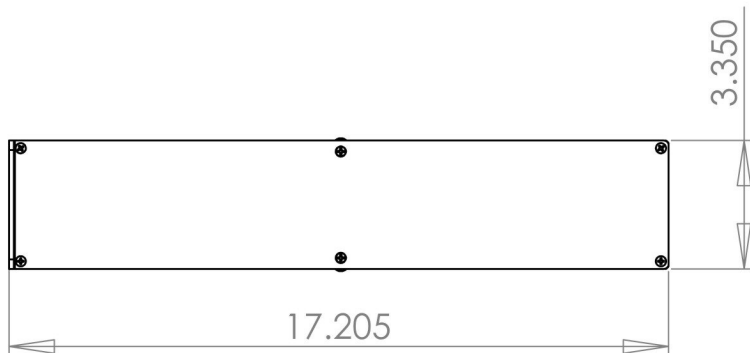
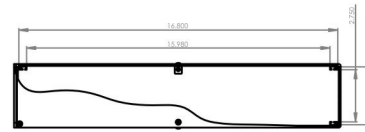
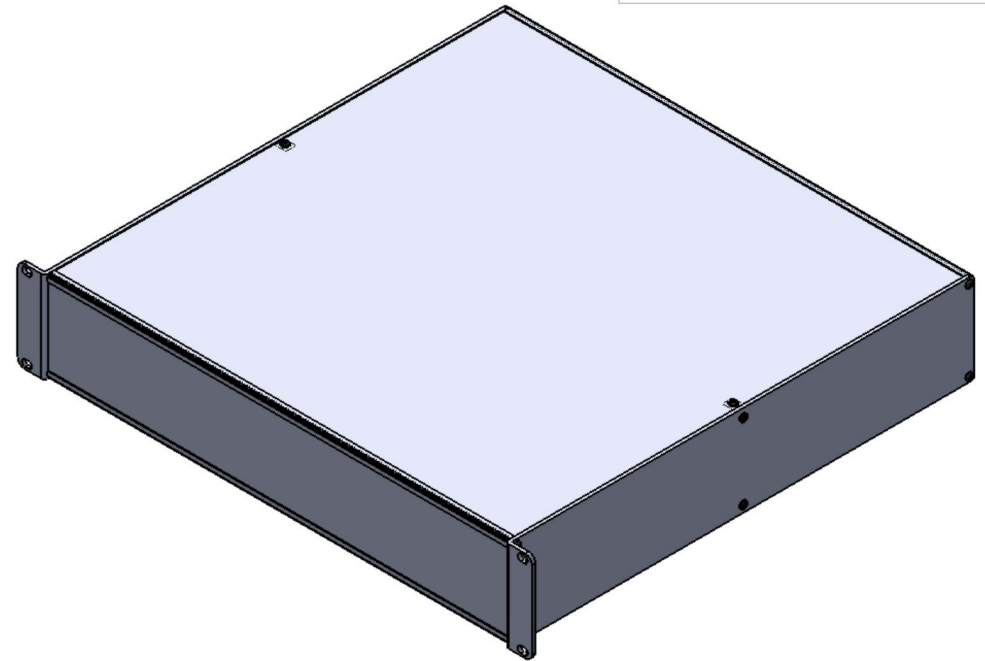
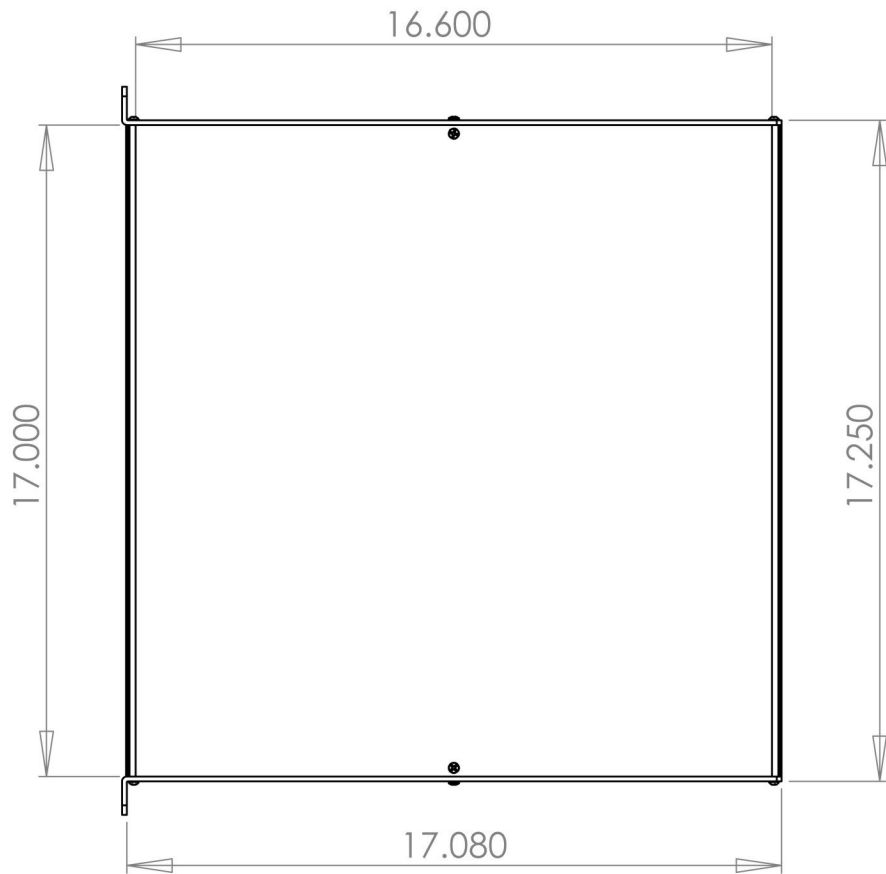

CONNECTRONICS
www.TecNec.com

PART NUMBER **CTX-2RU17**
 19 x 17 x 3.5 Aluminum Enclosure.
 Black Anodized

Unless otherwise specified, dimensions are in inches. Information in this drawing is provided for reference only.