

RACK MOUNTING

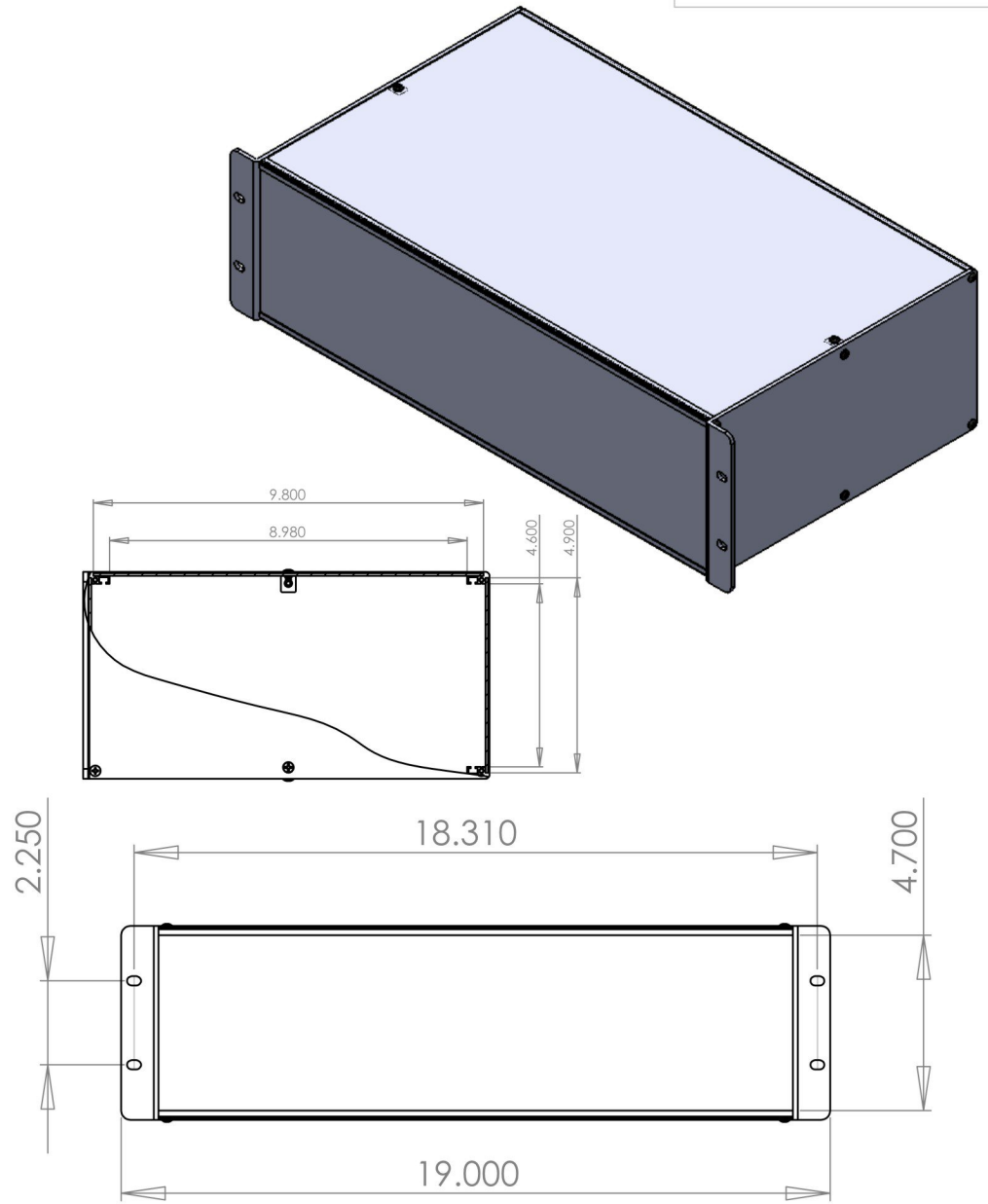
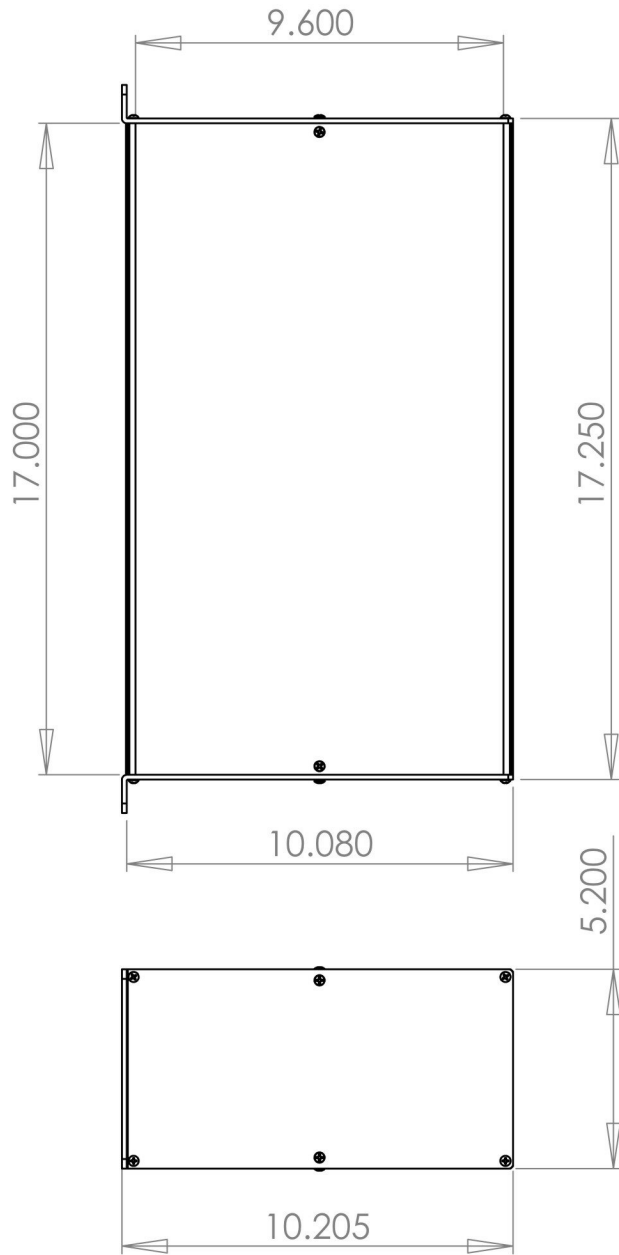

CONNECTRONICS
www.TecNec.com

PART NUMBER **CTX-3RU10**
 19 x 10 x 5.25 Aluminum Enclosure.
 Black Anodized

Unless otherwise specified, dimensions are in inches. Information in this drawing is provided for reference only.