

RACK MOUNTING

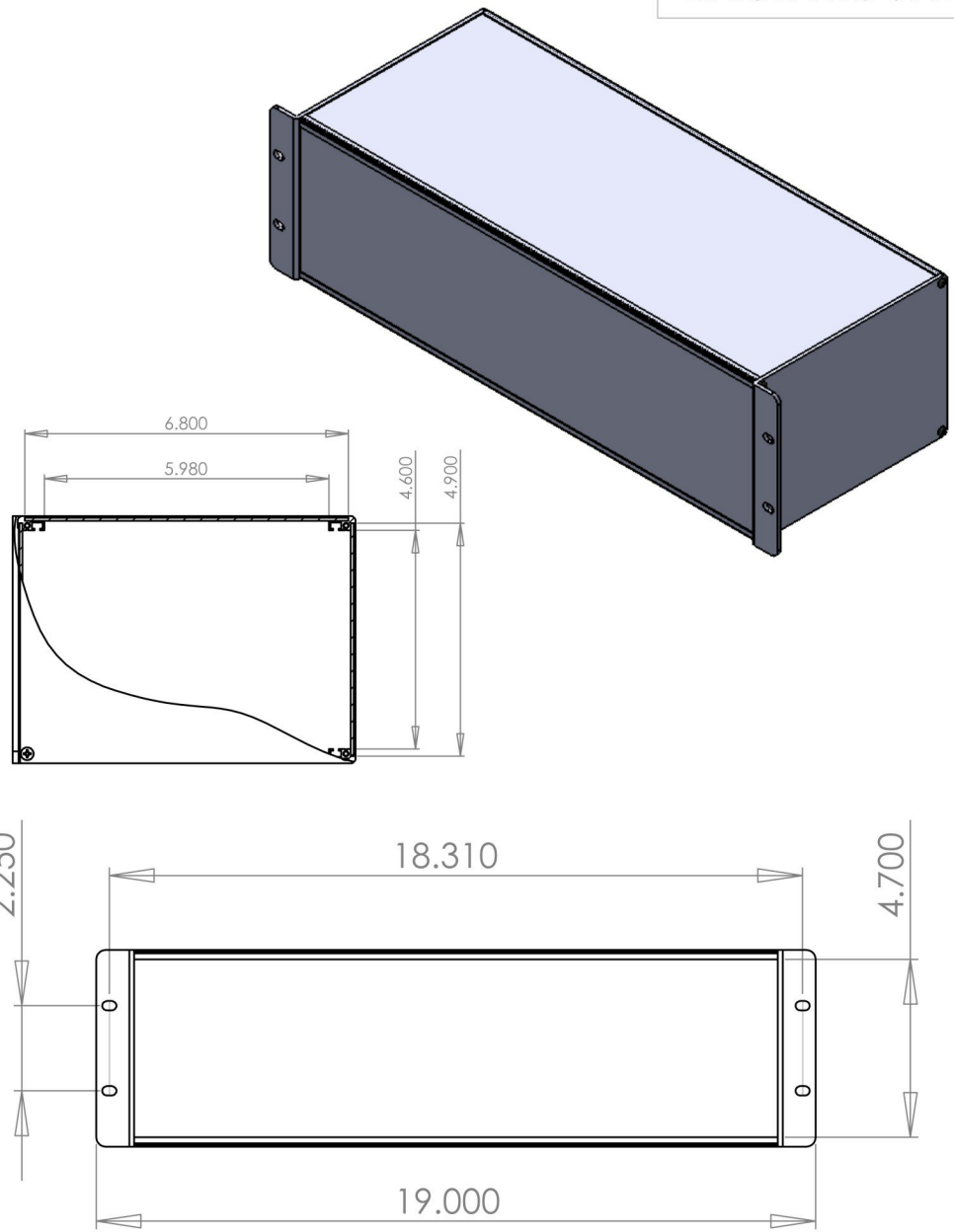
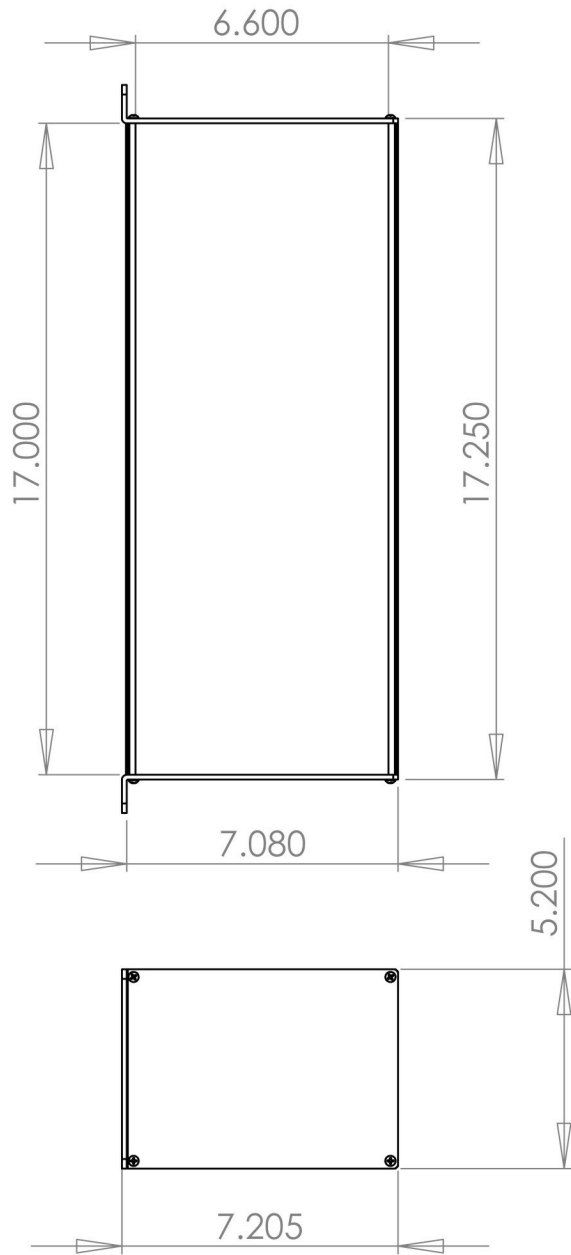

CONNECTRONICS

www.TecNec.com

PART NUMBER **CTX-3RU7**

19 x 7 x 5.25 Aluminum Enclosure.
Black Anodized

Unless otherwise specified, dimensions are in inches. Information in this drawing is provided for reference only.

5

4

3

2

1