

Small Format Mixers

XENYX UFX1604/UFX1204

**Premium 4-Bus Mixers with
16x4 USB/FireWire Interface, 16-Track
USB-Recorder, XENYX Mic Preamps
& Compressors, British EQs and
Multi-FX Processors**

**XENYX UFX1604 — Premium
16-Input 4-Bus Mixer with 16x4 USB/
FireWire Interface, 16-Track USB-
Recorder, XENYX Mic Preamps
& Compressors, British EQs and
Dual Multi-FX Processors**

- 8 state-of-the-art XENYX Mic Preamps comparable to stand-alone boutique preamps with individual Phantom Power switches
- 8 studio-grade Compressors with super-easy “one-knob” functionality and control LED for professional vocal and instrumental sound
- Neo-classic “British” 4-band EQs with two semi-parametric mid bands for warm and musical sound
- Dual studio-grade stereo FX processors with 16 editable presets including reverb, chorus, flanger, delay, pitch shifter, multi-effects, Tap function and storable user parameter settings
- 4 Aux Sends per channel - all pre/post fader switchable, 4 stereo Aux Returns and separate CD/Tape input
- Comprehensive Monitor section with separate level controls for speaker and headphones outputs



Boasting a stellar feature set that includes our premium-grade XENYX mic preamps, “one-knob” compressors, British EQs and 24-bit onboard FX, BEHRINGER UFX Series mixers are some of the best-sounding compact mixers you’ve ever heard. They are light-years beyond your average mixer, thanks to their built-in 16 x 4 USB/FireWire Interface and 16-Track USB-Recorder. Imagine being able to record your next live gig directly to a USB stick or your PC/Mac computer—and the UFX’s transport section can even function as a remote control center for your computer-based DAW via MIDI.

Extreme Versatility

From input to output, BEHRINGER UFX Series mixers are all about functionality, ease of use and ultimate versatility. Mono channels feature our legendary XENYX mic preamps, praised the world over by professional audio engineers for their sonic clarity and high-headroom performance. Mono channels accept both balanced XLR and ¼" TRS, as well as unbalanced ¼" TS connections. A Line/Hi-Z switch is also provided on channels 1 & 2 so you can connect acoustic, electric and bass guitars without the need for an external DI box.

Continued on next page



XENYX UFX1604/ UFX1204

UFX1204 — Premium 12-Input 4-Bus Mixer with 16x4 USB/FireWire Interface, 16-Track USB-Recorder, XENYX Mic Preamps & Compressors, British EQs and Multi-FX Processor

- 4 state-of-the-art XENYX Mic Preamps comparable to stand-alone boutique preamps with individual Phantom Power switches
- 4 studio-grade Compressors with super-easy “one-knob” functionality and control LED for professional vocal and instrumental sound
- Neo-classic “British” 3-band EQs with semi-parametric mid band for warm and musical sound
- Studio-grade stereo FX processor with 16 editable presets including reverb, chorus, flanger, delay, pitch shifter, multi-effects, Tap function and storable user parameter settings
- 2 Aux Sends per channel - all pre/post fader switchable, 2 stereo Aux Returns and separate CD/Tape input
- Comprehensive Monitor section with separate level controls for speaker and headphones outputs

Common Features

- Premium ultra low-noise, high headroom analog mixer with integrated 24-Bit/96 kHz USB/FireWire interface and 16-track USB recorder
- Built-in 16x4 interface connects directly to your computer and supports Mac OS X and Windows XP or higher

Built-in 16-Track Recorder

UFX Series mixers make it easy to capture your live performances or home recording sessions. Just plug a USB stick into the rear panel, hit the record button on the 16-track recorder control interface—then relax and enjoy the show. When you get home from the gig, you can even use control any compatible computer based DAW directly from your UFX mixer via MIDI.

British EQ

The British consoles of the 1960s and ‘70s changed the sound of rock and roll. Without them, the British Invasion might not have even happened. The channel EQ on our XENYX mixers is based on that very same circuitry, allowing you to imbue signals with incredible warmth and detailed musical character. Even when applied generously, these equalizers exhibit sweet forgiveness and superb audio quality.

Mono channels on the UFX1204 benefit from our highly musical “British” 3-band EQ with semi-parametric Mid control, allowing you to dial in the frequency center and boost or cut by as much as 15 dB. Channel EQ on the UFX1604 is an expanded 4-band version with sweepable Hi and Low Mids, providing even more tonal optimization. Both models feature individually switchable, true +48 V phantom power on all mono channels so you can use top-of-the-line studio condenser microphones—a feature virtually unheard of on a mixer in this class!

Stereo channels support balanced and unbalanced ¼" Line connections and our 4-band “British” EQs are provided for tonal adjustment. All channels feature 4 Aux Sends, switchable Pre/Post FireWire Sends, Mute/Alt 3-4 functionality and

super-smooth, long-wearing 100 mm logarithmic-taper faders (UFX1204 only for Main Mix fader, channel faders are 60 mm).

What's a Compressor?

Ask professional sound engineers what their favorite piece of external processing gear is and the response will be virtually unanimous – dynamic compression. What's compression? Glad you asked. Compression limits the dynamic range of a signal, lowering the level of loud sounds and turning up softer sounds to achieve sonic balance. But applying compression is a delicate art that many novice, and even intermediate sound techs have difficulty mastering. Our “one-knob” compression is available on all mono channels and is easy to operate, even for entry-level users. Now you can easily dial in the perfect amount of compression for instruments and vocals, creating powerful mixes with punch and clarity. Our “one-knob” compressors come standard on each and every XENYX QX Series USB mixer.

FX and Functionality

We gave the UFX1204 a very high-end stereo FX processor with 16 editable presets that include reverb, chorus, flanger, delay, phaser, multi-effects and Tap function for the ultimate in live performance enhancement. And because you can never have too much of a good thing, we armed the UFX1604 with not one, but two of these powerful effects engines for even more versatility.

Add to this an extensive Talkback section with onboard Mic; mono channel Inserts; up to 4 stereo Aux Returns; a plethora of output options; plus free software downloads and more—and you've got the incredible new XENYX UFX Series mixers from BEHRINGER!



Built-in 16 x 4 USB/FireWire Interface and 16-Track USB-Recorder

XENYX UFX1604/ UFX1204

- Integrated 16-track USB recorder allows for instant recordings of your studio or live sessions on a simple USB stick
- Neo-classic “British” EQs with semi-parametric mid band(s) for warm and musical sound
- Illuminated MIDI Transport section to remote-control your DAW/Sequencer on PC/Mac
- 2 Hi-Z inputs for direct connection of guitars, 4/8 Channel Inserts and balanced Main Mix outputs on 1/4" TRS and XLR connectors
- Solo-In-Place with PFL/AFL function plus full-featured Talkback section
- Comprehensive Monitor section with separate level controls for speaker and headphones outputs
- Long-wearing 100-mm logarithmic-taper faders (UFX1204 only for MAIN MIX fader, channel faders are 60 mm) and sealed rotary controls
- “Planet Earth” switching power supply for maximum flexibility (100 - 240 V~), noise-free audio, superior transient response plus low power consumption for energy saving
- High-quality components and exceptionally rugged construction ensure long life
- Conceived and designed by BEHRINGER Germany

UFX1604 channel strip

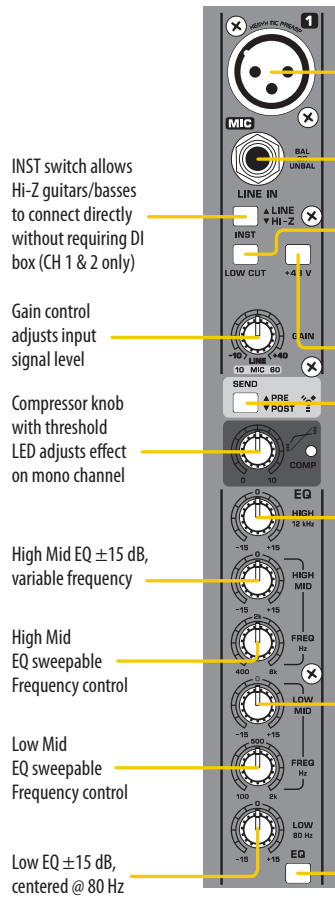

UFX1204 channel strip

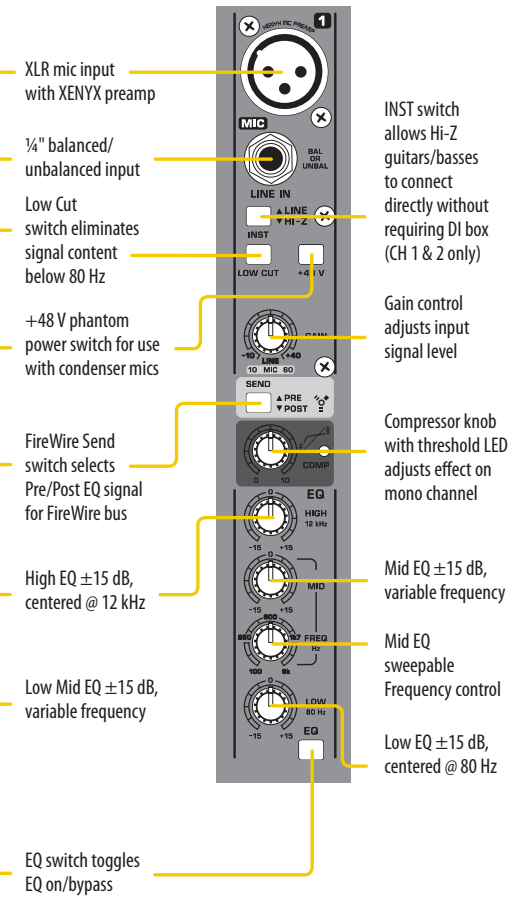

UFX Series Stereo Channel Strip

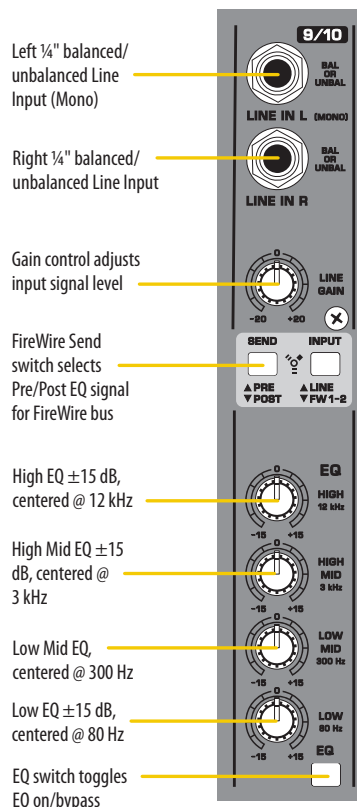

UFX Series FX Processor

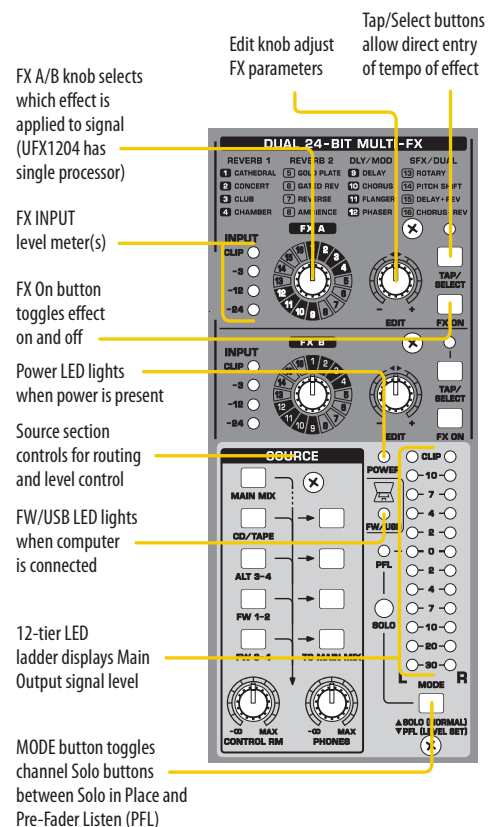

XENYX UFX1604/ UFX1204

UFX Series Stereo Channel Strip

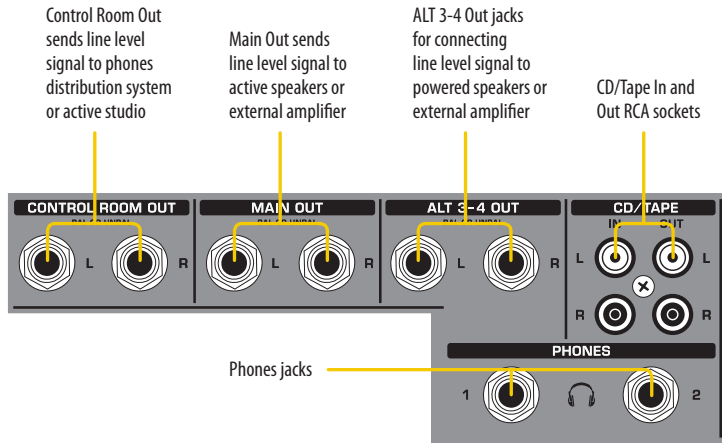

UFX Series Aux Sends>Returns

(UFX1204 has 2 Aux Sends and 2 Stereo Aux Returns)

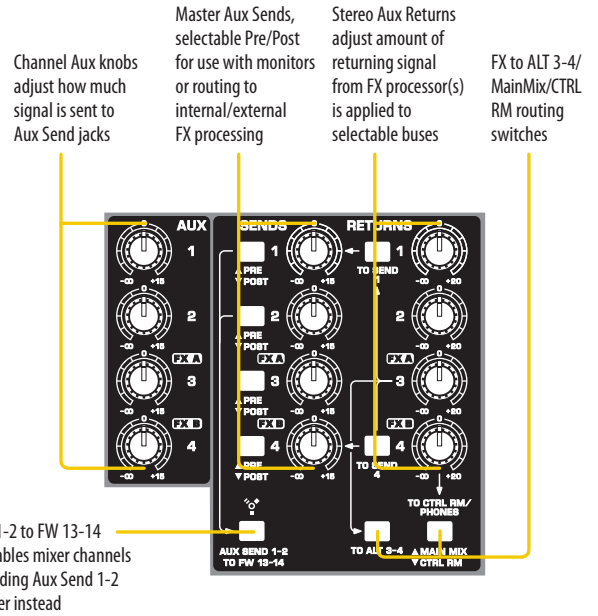

*Please note for UFX1604: "TO ALT 3-4 switch" is related to RETURN 3 (FX A), while "TO CTRL RM/PHONES" is related to RETURN 4 (FX B)

UFX Series Rear Panel

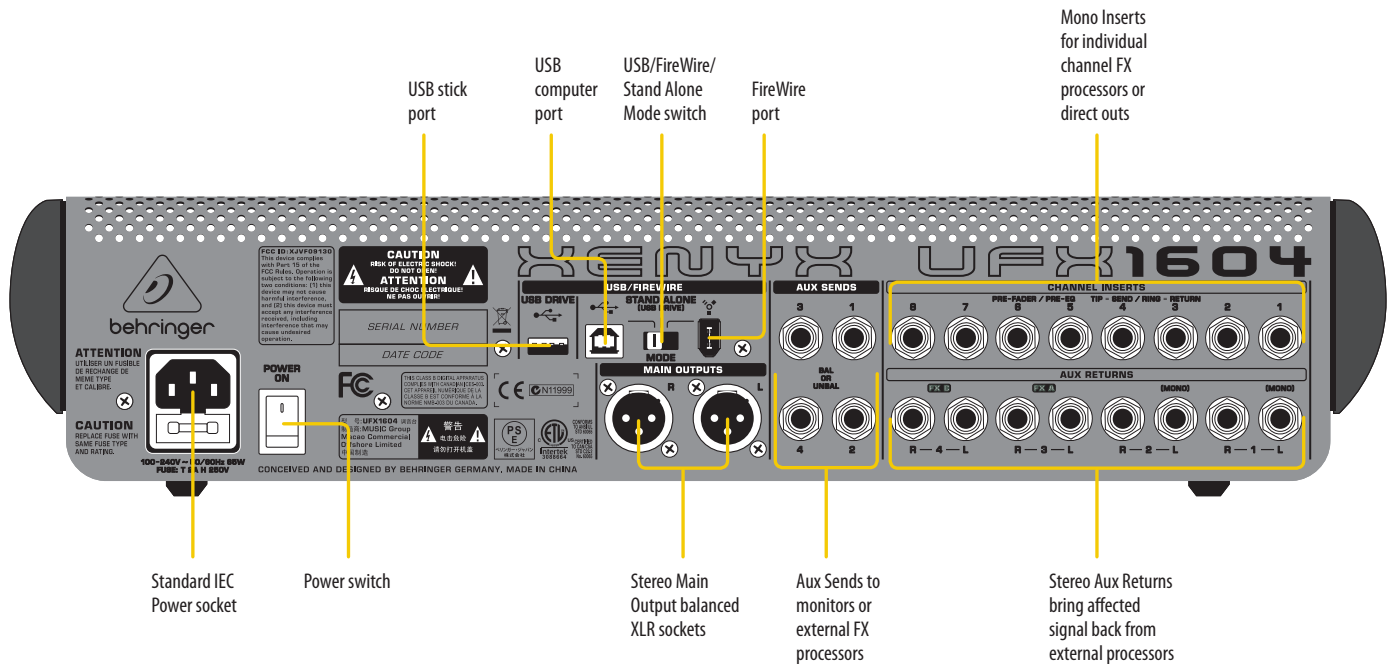

XENYX UFX1604/ UFX1204

UFX1604 Live Performance Setup

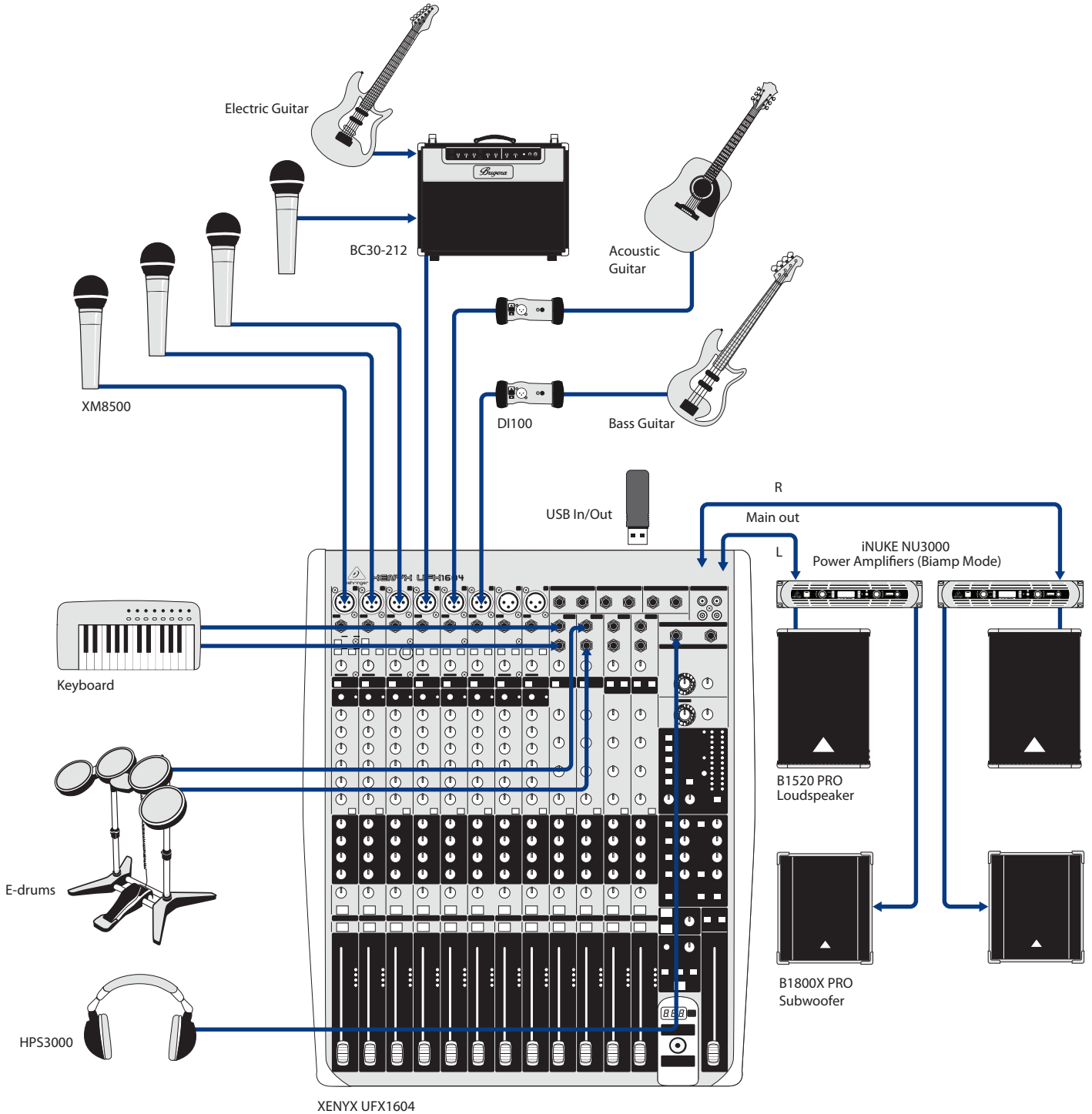

XENYX UFX1604/ UFX1204

UFX1204 Recording Setup

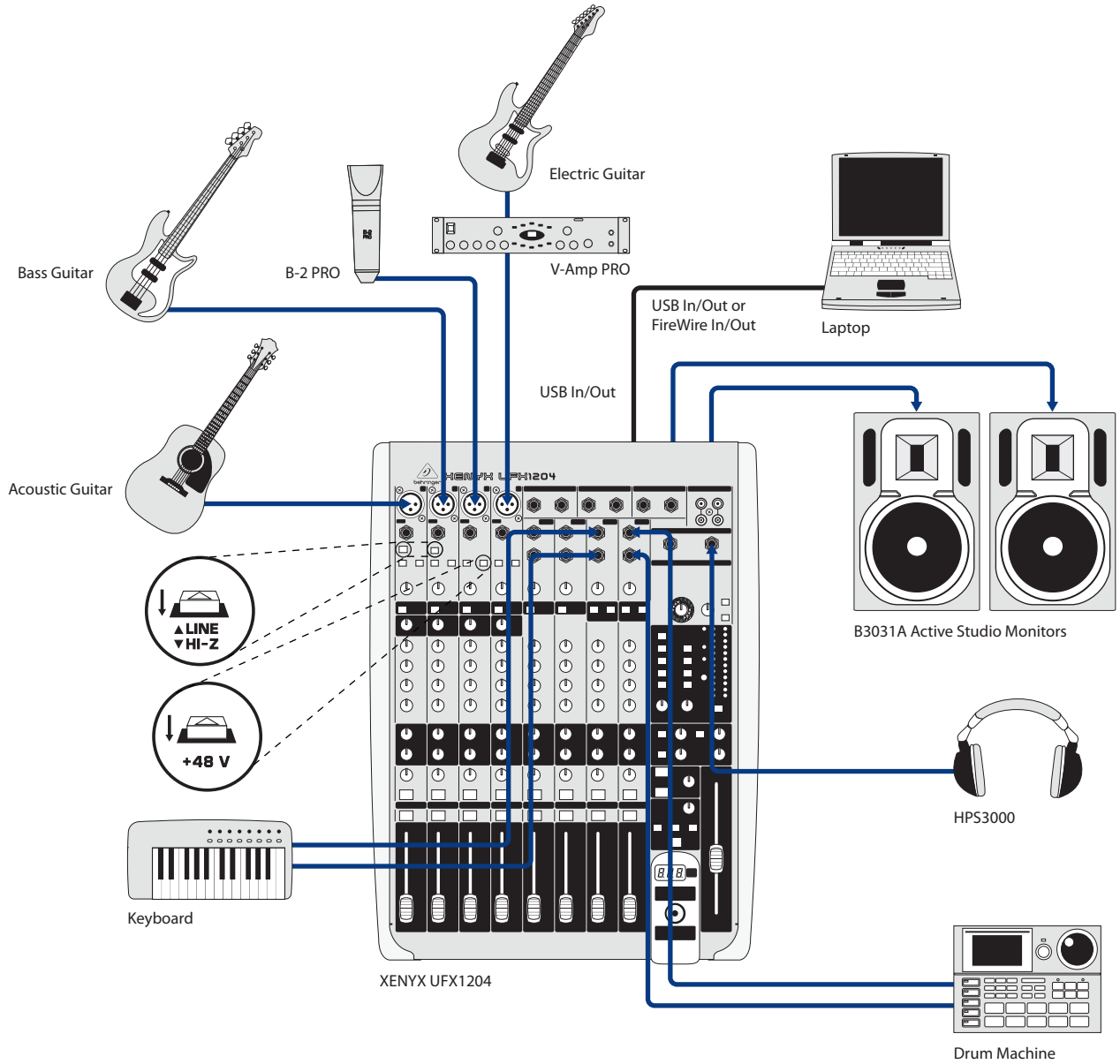

XENYX UFX1604/ UFX1204

Feature	UFX1204	UFX1604
Input Channels	12 (4 mono + 4 stereo)	16 (8 mono + 4 stereo)
Mic Preamps	4	8
Hi-Z Inputs	2	2
1-knob compressors	In all mono channels	In all mono channels
EQ @ mono channels	3-band semi-parametric	4-band semi-parametric
EQ @ stereo channels	4-band fixed	4-band fixed
Channel Inserts	4	8
Aux Sends	2 (both pre/post)	4 (all pre/post)
Aux Returns	2 stereo	4 stereo
Main Outputs	Dual XLR + 1/4" jacks	Dual XLR + 1/4" jacks
Subgroups	Alt 3-4 out	Alt 3-4 out
Phones	Dual 1/4" jacks	Dual 1/4" jacks
Talkback Section	With internal microphone	With internal microphone
24-bit Multi-FX Processors with editing and TAP function	1	2
Metering FX:	4 LEDs	2x4 LEDs
Metering Input Channels:	Each 4 LEDs	Each 4 LEDs
Metering Main Mix:	2x12 LEDs	2x12 LEDs
Channel Faders:	60 mm	100 mm
Main Mix Fader:	100 mm	100 mm
USB Recorder (records to a connected USB stick/driver)	Up to 16 tracks simultaneously recording, up to 24-bit @ 48 kHz, uncompressed WAV format	Up to 16 tracks simultaneously recording, up to 24-bit @ 48 kHz, uncompressed WAV format
Computer Audio Interface for Mac OS X and Windows XP or higher	USB or FireWire selectable, 16x4 I/O channels, up to 24-bit/96 kHz	USB or FireWire selectable, 16x4 I/O channels, up to 24-bit/96 kHz
16 Input channels (record) for USB recorder and audio interface mode	Input Ch. 1-12, Aux Send 1-2 (Ch. 13-14), Main Mix (Ch. 15-16)	Input Ch. 1-16, Aux Send 1-2 (alternative to Ch. 13-14), Main Mix (alternative to Ch. 15-16)
4 Output channels (playback) for USB recorder and audio interface mode	Routable to Input channels 9-12 or Control Room/Phones matrix	Routable to Input channels 13-16 or Control Room/Phones matrix
Illuminated transport section with display	To control USB recorder (standalone mode) or as remote control for your DAW on Win/Mac (USB/FW interface mode)	To control USB recorder (standalone mode) or as remote control for your DAW on Win/Mac (USB/FW interface mode)

For service, support or more information contact the BEHRINGER location nearest you:

Europe
MUSIC Group Services UK
Tel: +44 156 273 2290
Email: CARE@music-group.com

USA/Canada
MUSIC Group Services NV Inc.
Tel: +1 702 800 8290
Email: CARE@music-group.com

Japan
MUSIC Group Services JP K.K.
Tel: +81 3 6231 0454
Email: CARE@music-group.com

Technical specifications and appearances are subject to change without notice and accuracy is not guaranteed. BEHRINGER is part of the MUSIC Group (music-group.com). All trademarks are the property of their respective owners. MUSIC Group accepts no liability for any loss which may be suffered by any person who relies either wholly or in part upon any description, photograph or statement contained herein. Colors and specifications may vary from actual product. MUSIC Group products are sold through authorized fulfillment and resellers only. Fulfillment and resellers are not agents of MUSIC Group and have absolutely no authority to bind MUSIC Group by any express or implied undertaking or representation. This manual is copyrighted. No part of this manual may be reproduced or transmitted in any form or by any means, electronic or mechanical, including photocopying and recording of any kind, for any purpose, without the express written permission of MUSIC Group IP Ltd. ALL RIGHTS RESERVED. © 2012 MUSIC Group IP Ltd. Trident Chambers, Wickhams Cay, P.O. Box 146, Road Town, Tortola, British Virgin Islands.