

Canon EF LENS

EF300mm f/2.8L IS II USM

EF400mm f/2.8L IS II USM



IMAGE STABILIZER

ENG

Instructions

Thank you for purchasing a Canon product.

Canon's EF300mm f/2.8L IS II USM and EF400mm f/2.8L IS II USM are high-performance super-telephoto lenses, for use with EOS cameras.

- "IS" stands for Image Stabilizer.
- "USM" stands for Ultrasonic Motor.

Features

1. The Image Stabilizer gives the equivalent effect of a shutter speed four stops* faster. Also, a third Image Stabilizer mode effective for shooting irregularly moving subjects.
2. Use of fluorite lens elements giving superior definition.
3. SWC (Subwavelength Structure Coating) reduces flare and ghosting.
4. Using a fluorine coating on the foremost and rearmost lens surfaces allows adhered dirt to be removed more easily than before.
5. Ultrasonic motor (USM) for fast, quiet autofocus.
6. Manual focusing is available after the subject comes into focus in autofocus mode (ONE SHOT AF).
7. An AF stop button to pause autofocus whenever desired.
8. A power focus mode enables smooth focus change.
9. A focus preset function for advance storage of focusing positions in memory to allow instantaneous focusing.
10. Circular aperture for producing beautiful softfocus images.
11. Can be used with EF1.4x III/EF2x III extenders.
12. Attachment slot provided for wire-type security lock, located under the cover for the orientation locking knob.
13. Tight seal structure ensures excellent dustproof and drip-proof performance.
14. Designed for lighter weight with parts made of magnesium alloy.

* Based on [1/focal length] second.
Generally, it requires a shutter speed [1/focal length] second or faster to prevent camera shake.

Safety Precautions

Handling Cautions

- **If the lens is taken from a cold environment into a warm one, condensation may develop on the lens surface and internal parts.** To prevent condensation in this case, first put the lens into an airtight plastic bag before taking it from a cold to warm environment. Then take out the lens after it has warmed gradually. Do the same when taking the lens from a warm environment into a cold one.
- Do not leave the lens in excessive heat such as in a car in direct sunlight. **High temperatures can cause the lens to malfunction.**

Conventions used in this instruction



Warning to prevent lens or camera malfunction or damage.



Supplementary notes on using the lens and taking pictures.

Safety Precautions

- **Do not look at the sun or a bright light source through the lens or camera.** Doing so could result in loss of vision. Looking at the sun directly through the lens is especially hazardous.
- **Do not point the lens or camera at the sun or photograph it.** This is because the lens concentrates the sun's rays even when the sun is outside the image area or when shooting with backlight, which could cause malfunction or fire.
- **Whether it is attached to the camera or not, do not leave the lens under the sun without the lens cap attached.** This is to prevent the lens from concentrating the sun's rays, which could cause a fire.
- When the lens is mounted on a camera, be sure to also hold the camera by the lens, including when mounting on a tripod. Only holding by the camera could result in scratches on the camera body or the lens itself. The lens may also detach from its mount and fall, causing injury.
- Do not use a strap attached to the camera. The mount may break, resulting in the lens falling off and causing injury or in scratches on the camera. Be sure to use the camera with a dedicated strap attached correctly to the strap mount on the lens.
- Do not stand on top of the lens case. You may fall and injure yourself.
- Do not pile lens cases on top of one another as they may fall and cause injury.

Safety Precautions

This device complies with Part 15 of the FCC Rules. Operation is subject to the following two conditions: (1) This device may not cause harmful interference, and (2) this device must accept any interference received, including interference that may cause undesired operation.

Do not make any changes or modifications to the equipment unless otherwise specified in the instructions. If such changes or modifications should be made, you could be required to stop operation of the equipment.

This equipment has been tested and found to comply with the limits for a class B digital device, pursuant to part 15 of the FCC Rules. These limits are designed to provide reasonable protection against harmful interference in a residential installation. This equipment generates, uses and can radiate radio frequency energy and, if not installed and used in accordance with the instructions, may cause harmful interference to radio communications.

However, there is no guarantee that interference will not occur in a particular installation. If this equipment does cause harmful interference to radio or television reception, which can be determined by turning the equipment off and on, the user is encouraged to try to correct the interference by one or more of the following measures:

- Reorient or relocate the receiving antenna.
- Increase the separation between the equipment and receiver.
- Consult the dealer or an experienced radio/TV technician for help.

This Class B digital apparatus complies with Canadian ICES-003.

Nomenclature

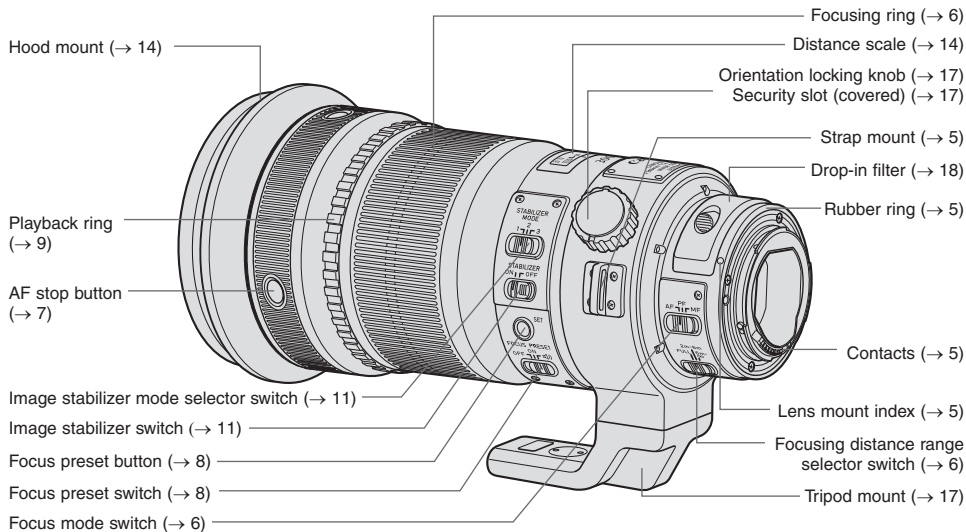

- The illustrations used in the explanations in this manual show, with a few exceptions, the EF300mm f/2.8L IS II USM, but the EF400mm f/2.8L IS II USM is used in the same way.
- For detailed information, reference page numbers are provided in parentheses (→ **).

1. Mounting and Detaching the Lens

See your camera's instructions for details on mounting and detaching the lens.

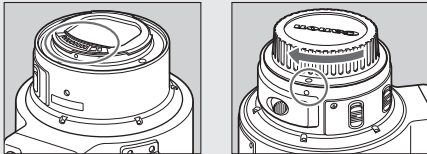

- After detaching the lens, place the lens with the rear end up to prevent the lens surface and contacts from getting scratched.
- If the contacts get soiled, scratched, or have fingerprints on them, corrosion or faulty connections can result. The camera and lens may not operate properly.
- If the contacts get soiled or have fingerprints on them, clean them with a soft cloth.
- If you remove the lens, cover it with the dust cap. To attach it properly, align the lens mount index and the O index of the dust cap as shown in the diagram, and turn clockwise. To remove it, reverse the order.



The lens mount has a rubber ring for enhanced dust- and water-resistance. The rubber ring may cause slight abrasions around the camera's lens mount, but this will not cause any problems. If the rubber ring becomes worn, it is replaceable by a Canon Service Center at cost.

Attaching the strap

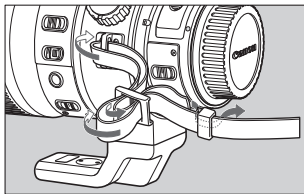

Thread the end of the strap through the strap mount on the lens and then back through the clasp on the strap. Pull the strap tight and check that there is no slack in the clasp.

2. Setting the Focus Mode

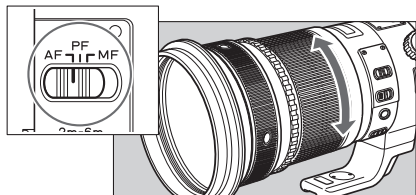

To shoot in autofocus (AF) mode, set the focus mode switch to AF.

To shoot in manual focus (MF) mode, set the focus mode switch to MF, and focus by turning the focusing ring. The focusing ring always works, regardless of the focus mode.

To shoot in power focus (PF) mode, set the focus mode switch to PF when the focus preset switch (p. 8) is at OFF.

Operating the playback ring enables focus change at a set speed. This is a useful feature for changing focus when shooting movies.

 After autofocus in ONE SHOT AF mode, focus manually by pressing the shutter button halfway and turning the focusing ring. (Full-time manual focus)

3. Switching the Focusing Distance Range

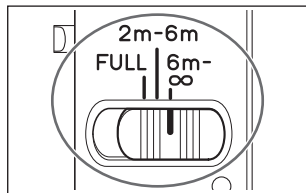

You can set the focusing distance range with a switch. By setting a suitable focusing distance range, the actual autofocus time will be shorter.

Lens	Ranges
	FULL
EF300mm f/2.8L IS II USM	2 m/6.6 ft. – 6 m/19.7 ft.
	6 m/19.7 ft. – ∞
EF400mm f/2.8L IS II USM	FULL
	2.7 m/8.9 ft. – 7 m/23 ft.
	7 m/23 ft. – ∞

4. AF Stop Button

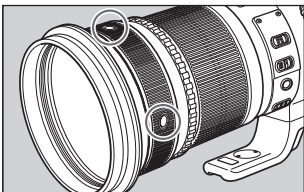

During autofocus operation, you can press the AF stop button to temporarily pause autofocus. If the shutter button is still pressed halfway when the AF stop button is released, autofocus will continue as before.



The AF stop function also works in AI Servo AF mode. Angle positioning of the AF stop button is adjustable by a Canon Service Center at cost.





- With the EOS 630/600, RT, A2/A2E/5, or 10S/10 set to the AI Servo AF mode and continuous shooting, AF will not resume even after you let go of the AF stop button. Press the shutter release button halfway to resume AF.
- With the EOS A2/A2E/5 and 10S/10 set to the Sports mode, AF will not resume even after you let go of the AF stop button. Press the shutter release button halfway to resume AF.
- You can change the functions of the AF stop button using the camera's Custom Function. For details, please refer to the camera's instructions.

5. Focus Preset

By presetting any focusing distance, you can instantly focus at that point even while you are shooting a different subject. This function operates in any of the AF, PF, and MF modes.

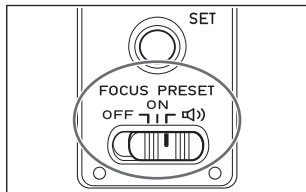
< How to Set >



- 1** Set the focus preset switch to ON or .

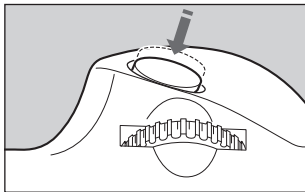

- 2** Press the shutter button halfway to focus the distance you want to preset.

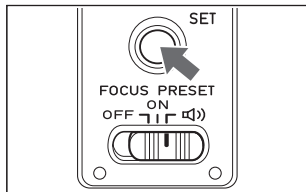

- 3** Press the focus preset button.

- The focused distance will be preset.
- If the focus preset switch was set to , the beeper will sound once.

Focus Preset

< How to Focus at the Preset Distance >

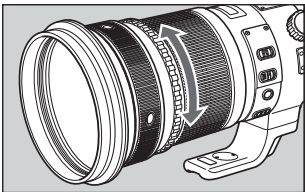

By turning the playback ring to the left or right, the focus shifts as far as the preset distance. Focus will shift freely released of AF focusing while the playback ring is still turned.

- If the focus preset switch was set to , the beeper will sound twice.

Setting the focus mode switch to power focus (PF) when using the lens with the EOS-1D X or EOS 5D Mark III enables focus change at a slow set speed during movie shooting. Also, you can make a 2-step change in focus shift speed depending on the angle that the playback ring is rotated to.

-  When turning the playback ring, keep your finger away from the shutter button. In One-Shot AF mode, the exposure will be locked when you press the shutter button halfway and focus is achieved. So if you press the shutter button halfway while turning the playback ring, the exposure may not be correct.
- When not using the focus preset, set the switch to OFF.
- The focus preset function will not work while a Live View image is displayed on the camera.*

* Not applicable to the EOS-1D X or EOS 5D Mark III

-  In the following cases, the focusing distance scale (p. 14) will move slightly. It will not affect the image.
- When you press the focus preset button.
- When you turn the playback ring.

6. Power Focus (PF) Mode

Using the playback ring enables smooth focus change.
This is a useful feature for changing focus when shooting movies.

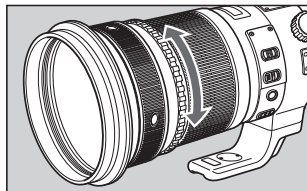
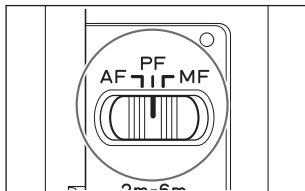
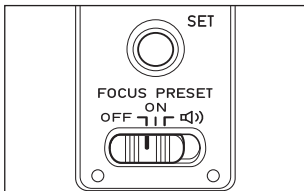

- 1 With the focus preset switch set to OFF, set the focus mode switch to PF.

- 2 Rotate the playback ring to change the focus.

When the playback ring is rotated in a certain direction, focus changes in the same direction as when the focusing ring is rotated.

You can make a 2-step change in focus shift speed depending on the angle that the playback ring is rotated to.

7. Image Stabilizer

You can use the image stabilizer in AF, PF, or MF mode.

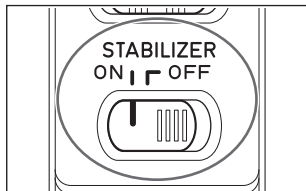

1 Set the STABILIZER switch to ON.

- If you are not going to use the image stabilizer function, set the switch to OFF.

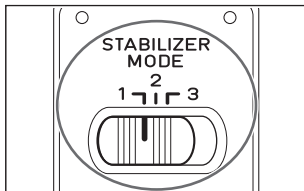

2 Select the stabilizer mode.

- MODE 1: Corrects vibrations in all directions. It is mainly effective for shooting still subjects.
- MODE 2: Corrects vertical camera shake during following shots in a horizontal direction, and corrects horizontal camera shake during following shots in a vertical direction.
- MODE 3: Corrects vibration only during exposure. During panning shots, corrects vibration during exposure only in one direction the same as MODE 2.

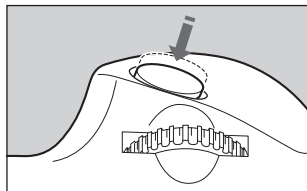

3 First press the shutter button down halfway, then press down all the way to take the picture.

- MODE 1, 2: Press the shutter button down halfway to stabilize the image in the viewfinder and enable stabilization.
- MODE 3: Press the shutter down halfway to initiate computation of stabilization, then press down all the way to enable stabilization.

8. Tips on Using the Image Stabilizer

The image stabilizer for this lens is effective for hand-held shots in the following conditions.

● MODE 1



ON

OFF

- In semi-darkened areas such as indoors or outdoors at night.
- In locations where flash photography is prohibited, such as art museums and theater stages.
- In situations where your footing is uncertain.
- In situations where fast shutter settings cannot be used.

● MODE 2



ON

OFF

- When panning subjects in motion.

● MODE 3

- Since camera shake is stabilized only during exposure, following a subject is easier such as when shooting a fast and irregularly moving player during sports photography.

Tips on Using the Image Stabilizer

- The Image Stabilizer cannot compensate for a blurred shot caused by a subject that moved.
- Set the STABILIZER switch to OFF when you are taking pictures using the Bulb setting (long exposures). If the STABILIZER switch is set to ON, the image stabilizer function may introduce errors.
- The Image Stabilizer might not be fully effective in the following cases:
 - You shoot from a violently moving vehicle.
 - You move the camera dramatically for a panning shot in Mode 1.
- The Image Stabilizer consumes more power than normal shooting, so fewer shots can be taken if you use the function.
- The image stabilizer operates for about two seconds even when your finger is off the shutter button. Do not remove the lens while the stabilizer is in operation. This will cause a malfunction.
- With the EOS-1V/HS, 3, ELAN 7E/ELAN 7/30/33, ELAN 7NE/ELAN 7N/30V/33V, ELAN II/ELAN II E/50/50E, REBEL 2000/300, IX, IX Lite/IX7, and D30, the Image Stabilizer will not work during self-timer operation.



- Using a tripod also stabilizes the image. However, depending on the kind of tripod and shooting conditions, sometimes it may be better to turn off the Image Stabilizer function.
- The stabilizer is equally effective for hand-held photography and photography with a monopod. The Image Stabilizer effect may be reduced, however, depending on the shooting environment.
- The Image Stabilizer also operates when the lens is used with extension tube EF12 II or EF25 II or the extender EF1.4× III or EF2× III.
- Depending on the camera there may be image shake, such as after releasing the shutter. However, this does not affect shooting.
- If you set the camera's Custom Function to change the assigned button to operate the AF, the Image Stabilizer will operate when you press the newly assigned AF button.

9. Infinity Compensation Mark

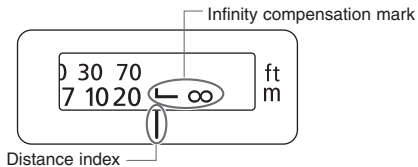

To compensate for shifting of the infinity focus point that results from changes in temperature. The infinity position at normal temperature is the point at which the vertical line of the distance scale L mark is aligned with the distance index.

I For accurate focusing in MF on subjects at infinity distance, look through the viewfinder while rotating the focusing ring.

10. Hood

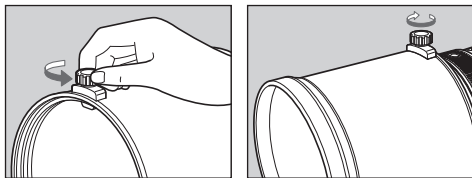

The special hoods that come with all these lenses cut out unwanted light and protect the front of the lens from rain, snow, and dust.

To attach the hood, loosen the hood lock knob by turning it counterclockwise. Fit the hood onto the lens's hood mount, and tighten the lock knob to fix it in place. Use the same procedure, in reverse, to remove the hood.

11. Fitting the Lens Cap

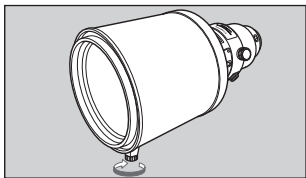

- 1 Reverse the lens hood, slip it over the lens, and tighten the lock knob to fix it in place.

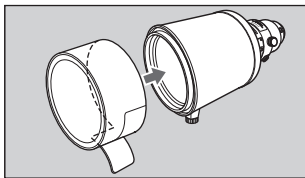

- 2 Lift the hook and loop fastener, and fit the cap so that the lock knob rides up the slot in the cap.

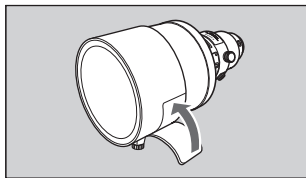

- 3 With the lock knob at the opening in the cap, close the fastener to fix the cap in place as shown.
- Can also be attached to the front of the hood when using the lens.

12. Case

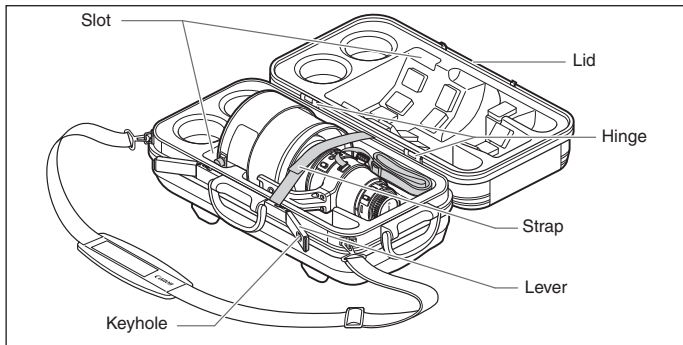

The illustration shows the EF400mm f/2.8L IS II USM.

Put the lens away as follows.

- 1** Reverse the lens hood, slip it over the lens, and attach the lens cap.
- 2** Position the tripod mount towards you as shown and place it in the case.

Place so that the hood's lock knob rests in the slot near you.

Fold the strap and fit it into the space near the case hinges.

- 3** Fasten the lens securely with the strap.
- 4** Close the lid, and then push the lever while holding the lid from above to lock.



- Do not sit on top of the lens case.
- Place the lens in the position intended for it.

13. Using the Tripod Mount

A tripod or monopod attaches to the tripod mount on the lens.

Adjusting the Tripod Mount

By loosening the orientation locking knob on the tripod mount you can rotate the camera to set the image for any vertical or horizontal position.

Replacing the Tripod Mount (EF400mm f/2.8L IS II USM only)

Replacement with the included monopod mount can be done at a Canon Service Center at cost. Since the mount requires special fastening, as a safety precaution, do not replace the mount yourself.

14. Security Slot

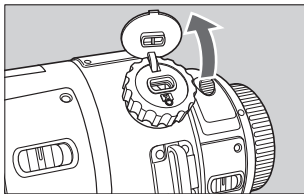

An attachment slot is provided for a wire-type security lock. The slot is located under the cover for the orientation locking knob.

A wire-type security lock can be purchased separately.

15. Drop-In Filters

A 52(WII)-series drop-in gelatin filter holder with a glass filter is included with the lens. The drop-in filter holder can be used fitted with a gelatin filter (sold separately).

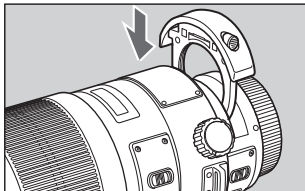

<Installing and Removing>

To remove the drop-in filter, press in the left and right lock buttons and pull the filter holder straight out of the slot.

To install the drop-in filter, push the filter holder straight down into the slot until it clicks into place.

- The filter holder can be installed facing either forwards or backwards.

! Because the lens optics are designed to include a glass filter, you must always install the filter holder, even if no gelatin filter is fitted.

<Using a Gelatin Filter>

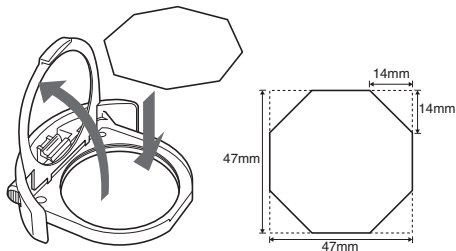

- 1** Lift up the holder's retaining plate.
- 2** Cut the gelatin filter as shown and mount it in the holder.
- 3** Return the retaining plate to its closed position.

! The Drop-In Screw-Type Filter Holder 52(WII) and Drop-In Circular Polarizing Filter PL-C52(WII) are also available (sold separately).

16. Extenders (Sold Separately)

Lens specifications when using extender EF1.4x II/III or EF2x II/III are as follows.

		EF300mm f/2.8L IS II USM		EF400mm f/2.8L IS II USM	
		EF1.4x II/III	EF2x II/III	EF1.4x II/III	EF2x II/III
Focal length (mm)		420	600	560	800
Aperture		f/4 – 45	f/5.6 – 64	f/4 – 45	f/5.6 – 64
Angle of view	Diagonal	5° 55'	4° 10'	4° 25'	3° 5'
	Vertical	3° 15'	2° 20'	2° 25'	1° 40'
	Horizontal	4° 55'	3° 30'	3° 40'	2° 35'
Maximum magnification (x)		0.25	0.36	0.25	0.35



- Attach the extender to the lens, and then attach the lens to the camera. To remove it, reverse the order. Errors may occur if you attach the extender to the camera first.
- When shooting with EOS A2/A2E/5 fitted with either the EF300mm f/2.8L IS II USM or EF400mm f/2.8L IS II USM, use -0.5 step exposure compensation when using extender EF1.4x II, and use -1 step exposure when using extender EF2x II.
- Extenders cannot be used more than one at a time.



- AF is possible with extender EF1.4x II/III or EF2x II/III.
- When an extender is attached, the AF speed will become slower to retain proper control.

17. Extension Tubes (Sold Separately)

You can attach extension tube EF12 II or EF25 II for magnified shots. The shooting distance and magnification are shown below.

EF300mm f/2.8L IS II USM

	Focusing Distance Range (mm)		Magnification (x)	
	Close distance	Long distance	Close distance	Long distance
EF12 II	1700	7529	0.22	0.04
EF25 II	1480	3727	0.28	0.09

EF400mm f/2.8L IS II USM

	Focusing Distance Range (mm)		Magnification (x)	
	Close distance	Long distance	Close distance	Long distance
EF12 II	2375	13353	0.21	0.03
EF25 II	2113	6494	0.26	0.07



MF mode is recommended for accurate focusing.

Specifications

	EF300mm f/2.8 IS II USM	EF400mm f/2.8 IS II USM
Focal Length/Aperture	300mm f/2.8	400mm f/2.8
Lens Construction	12 groups, 16 elements	12 groups, 16 elements
Minimum Aperture	f/32	f/32
Angle of View	Diagonal: 8° 15' Vertical: 4° 35' Horizontal: 6° 50'	Diagonal: 6° 10' Vertical: 3° 30' Horizontal: 5° 10'
Min. Focusing Distance	2 m/6.6 ft.	2.7 m/8.9 ft.
Max. Magnification	0.18x	0.17x
Field of View	Approx. 136 × 205 mm/ 5.4 × 8.1 inch (at 2 m/6.6 ft.)	Approx. 139 × 208 mm/ 5.5 × 8.2 inch (at 2.7 m/8.9 ft.)
Filter	Any 52(WII)-series drop-in filter	
Max. Diameter and Length	128 × 248 mm/5.0 × 9.8 inch	163 × 343 mm/6.4 × 13.5 inch
Weight	Approx. 2350 g/82.9 oz	Approx. 3850 g/135.8 oz
Hood	ET-120(WII)	ET-155(WII)
Lens Cap	E-145C	E-180D
Case	Lens case 300B	Lens case 400C

- The lens length is measured from the mount surface to the front end of the lens. Add 26.5 mm when including the lens cap and dust cap.
- The size and weight listed are for the lens only, except as indicated.
- The Close-up Lenses 250D and 500D cannot be attached.
- Aperture settings are specified on the camera.
- All data listed is measured according to Canon standards.
- Product specifications and appearance are subject to change without notice.

Canon