

Canon

PUB. DIM-1072-000A



VIXIA

HF G30

HD Camcorder
Quick Guide

English

Caméscope HD
Guide rapide

Français

Videocámara HD
Guía breve

Español

NTSC

MP4

HDMI

AVCHD
Progressive

WiFi
CERTIFIED

Important Usage Instructions

WARNING

TO REDUCE THE RISK OF FIRE OR ELECTRIC SHOCK, DO NOT EXPOSE THIS PRODUCT TO RAIN OR MOISTURE.

COPYRIGHT WARNING:

Unauthorized recording of copyrighted materials may infringe on the rights of copyright owners and be contrary to copyright laws.

The Mains plug is used as the disconnect device. The Mains plug shall remain readily operable to disconnect the plug in case of an accident.

CAUTION:

- Danger of explosion if the wrong type of batteries are attached. Use only the same type of batteries.
- Do not expose batteries or product to excessive heat such as the inside of a car under direct sunlight, fire, etc.

FCC/IC NOTICE

HD Camcorder, VIXIA HF G30 systems

This device complies with Part 15 of the FCC Rules. Operation is subject to the following two conditions: (1) This device may not cause harmful interference, and (2) this device must accept any interference received, including interference that may cause undesired operation.

Note: This equipment has been tested and found to comply with the limits for a class B digital device, pursuant to Part 15 of the FCC Rules. These limits are designed to provide reasonable protection against harmful interference in a residential installation. This equipment generates, uses and can radiate radio frequency energy and, if not installed and used in accordance with the instructions, may cause harmful interference to radio communications. However, there is no guarantee that interference will not occur in a particular installation. If this equipment does cause harmful interference to radio or television reception, which can be determined by turning the equipment off and on, the user is encouraged to try to correct the interference by one or more of the following measures:

- Reorient or relocate the receiving antenna.
- Increase the separation between the equipment and receiver.
- Connect the equipment into an outlet on a circuit different from that to which the receiver is connected.
- Consult the dealer or an experienced radio/TV technician for help.

Use of shielded cable is required to comply with class B limits in Subpart B of Part 15 of FCC Rules.

Do not make any changes or modifications to the equipment unless otherwise specified in the manual. If such changes or modifications should be made, you could be required to stop operation of the equipment.

Model ID0025 (including WLAN Module Model RF400, FCC ID: AZD400)

This device complies with Industry Canada license-exempt RSS standard(s). Operation is subject to the following two conditions: (1) this device may not cause interference, and (2) this device must accept any interference, including interference that may cause undesired operation of the device.

This transmitter must not be co-located or operated in conjunction with any other antenna or transmitter.

The available scientific evidence does not show that any health problems are associated with using low power wireless devices. There is no proof, however, that these low power wireless devices are absolutely safe. Low power wireless devices emit low levels of radio frequency energy (RF) in the microwave range while being used. Whereas high levels of RF can produce health effects (by heating tissue), exposure of low-level RF that does not produce heating effects causes no known adverse health effects. Many studies of low-level RF exposures have not found any biological effects. Some studies have suggested that some biological effects might occur, but such findings have not been confirmed by additional research. This model has been tested and found to comply with FCC/IC radiation exposure limits set forth for an uncontrolled equipment and meets the FCC radio frequency (RF) Exposure Guidelines in Supplement C to OET65 and RSS-102 of the IC radio frequency (RF) Exposure rules.

Compliance with FCC requirement 15.407(c)

Data transmission is always initiated by software, which is the passed down through the MAC, through the digital and analog baseband, and finally to the RF chip. Several special packets are initiated by the MAC. These are the only ways the digital baseband portion will turn on the RF transmitter, which it then turns off at the end of the packet. Therefore, the transmitter will be on only while one of the aforementioned packets is being transmitted. In other words, this device automatically discontinues transmission in case of either absence of information to transmit or operational failure.

Frequency Tolerance: 25 ppm

Canon U.S.A., Inc.

One Canon Park, Melville, NY 11747, USA

Tel No. 1-800-OK-CANON (1-800-652-2666)



CAUTION
RISK OF ELECTRIC SHOCK
DO NOT OPEN



The lightning flash with arrowhead symbol, within an equilateral triangle, is intended to alert the user to the presence of uninsulated "dangerous voltage" within the product's enclosure, that may be of sufficient magnitude to constitute a risk of electric shock to persons.

CAUTION:
TO REDUCE THE RISK OF ELECTRIC SHOCK, DO NOT REMOVE COVER (OR BACK). NO USER-SERVICEABLE PARTS INSIDE. REFER SERVICING TO QUALIFIED SERVICE PERSONNEL.



The exclamation point, within an equilateral triangle, is intended to alert the user to the presence of important operating and maintenance (servicing) instructions in the literature accompanying the product.

CAN ICES-3(B)/NMB-3(B)



WARNING

DO NOT INGEST BATTERY, CHEMICAL BURN HAZARD

The wireless controller contains a coin/button cell battery. If the coin/button cell battery is swallowed, it can cause severe internal burns in just 2 hours and can lead to death. Keep new and used batteries away from children. If the battery compartment does not close securely, stop using the product and keep it away from children. If you think batteries might have been swallowed or placed inside any part of the body, seek immediate medical attention.

IMPORTANT SAFETY INSTRUCTIONS

In these safety instructions the word “apparatus” refers to the Canon HD Camcorder VIXIA HF G30 and all its accessories.

- 1 Read these instructions.
- 2 Keep these instructions.
- 3 Heed all warnings.
- 4 Follow all instructions.
- 5 Do not use this apparatus near water.
- 6 Clean only with dry cloth.
- 7 Do not install near any heat sources such as radiators, heat registers, stoves, or other apparatus (including amplifiers) that produce heat.
- 8 Do not defeat the safety purpose of the polarized or grounding-type plug. A polarized plug has two blades with one wider than the other. A grounding type plug has two blades and a third grounding prong. The wide blade or the third prong are provided for your safety. If the provided plug does not fit into your outlet, consult an electrician for replacement of the obsolete outlet.
- 9 Protect the power cord from being walked on or pinched particularly at plugs, convenience receptacles, and the point where they exit from the apparatus.
- 10 Only use attachments/accessories specified by the manufacturer.
- 11 Unplug this apparatus during lightning storms or when unused for long periods of time.
- 12 Refer all servicing to qualified service personnel. Servicing is required when the apparatus has been damaged in any way, such as power-supply cord or plug is damaged, liquid has been spilled or objects have fallen into the apparatus, the apparatus has been exposed to rain or moisture, does not operate normally, or has been dropped.

CA-570 identification plate is located on the bottom.

Precautions About the Battery Pack

DANGER!

Treat the battery pack with care.

- Keep it away from fire (or it might explode).
- Do not expose the battery pack to temperature higher than 60 °C (140 °F). Do not leave it near a heater or inside a car in hot weather.
- Do not try to disassemble or modify it.
- Do not drop it or subject it to shocks.
- Do not get it wet.

REGIONS OF USE

VIXIA HF G30 is in compliance (as of April 2013) with the radio signal regulations of the regions listed below. For details on other regions where they can be used, make inquiries with the contacts listed on the back side of this instruction manual.

REGIONS

Canada, Hong Kong S.A.R., USA, South Korea

Model

ID0025: VIXIA HF G30

Important Note About the Memory



- Observe the following precautions while the ACCESS indicator is on or flashing. Failing to do so may result in permanent data loss or damage to the memory.
 - Do not open the memory card slot cover.
 - Do not disconnect the camcorder's power source or turn off the camcorder.
 - Do not change the camcorder's operating mode.

Trademark Acknowledgements

- SD, SDHC and SDXC Logos are trademarks of SD-3C, LLC.
- Microsoft and Windows are trademarks or registered trademarks of Microsoft Corporation in the United States and/or other countries.
- App Store, iPad, iPhone, iTunes and Mac OS are trademarks of Apple Inc., registered in the U.S. and other countries.
- HDMI, the HDMI logo and High-Definition Multimedia Interface are trademarks or registered trademarks of HDMI Licensing LLC in the United States and other countries.
- "AVCHD", "AVCHD Progressive" and the "AVCHD Progressive" logo are trademarks of Panasonic Corporation and Sony Corporation.
- Manufactured under license from Dolby Laboratories.
- "Dolby" and the double-D symbol are trademarks of Dolby Laboratories.
- Google, Android, Google Play, YouTube are trademarks of Google Inc.
- Facebook is a registered trademark of Facebook, Inc.
- IOS is a trademark or registered trademark of Cisco in the U.S. and other countries and is used under license.
- The Twitter name and marks are trademarks of Twitter, Inc.
- Wi-Fi is a registered trademark of the Wi-Fi Alliance.
- Wi-Fi Certified, WPA, WPA2, and the Wi-Fi Certified logo are trademarks of the Wi-Fi Alliance.
- WPS as used on the camcorder's settings, onscreen displays and in this manual signifies Wi-Fi Protected Setup.
- The Wi-Fi Protected Setup Identifier Mark is a mark of the Wi-Fi Alliance.
- Other names and products not mentioned above may be trademarks or registered trademarks of their respective companies.
- This device incorporates exFAT technology licensed from Microsoft.
- "Full HD 1080" refers to Canon camcorders compliant with high-definition video composed of 1,080 vertical pixels (scanning lines).
- This product is licensed under AT&T patents for the MPEG-4 standard and may be used for encoding MPEG-4 compliant video and/or decoding MPEG-4 compliant video that was encoded only (1) for a personal and non-commercial purpose or (2) by a video provider licensed under the AT&T patents to provide MPEG-4 compliant video. No license is granted or implied for any other use for MPEG-4 standard.



Package contents

- CA-570 Compact Power Adapter (incl. power cord and ferrite core) [①]
- BP-820 Battery Pack
- WL-D89 Wireless Controller (incl. CR2025 lithium button battery)
- HTC-100/S High Speed HDMI Cable [②]
- STV-250N Stereo Video Cable
- IFC-300PCU/S USB Cable [③]
- Lens hood with lens barrier [④]
- Lens cap [⑤]
- Wi-Fi Basic Setup Guide
-  **VIXIA** CD-ROM
Contains the full-version Instruction Manual of the camcorder (PDF file) and an automatic installer for the software, **ImageBrowser EX** ( PDF 108). See the explanation on next page.
- Data Import Utility CD-ROM
Contains the software, **Data Import Utility** ( PDF 109)

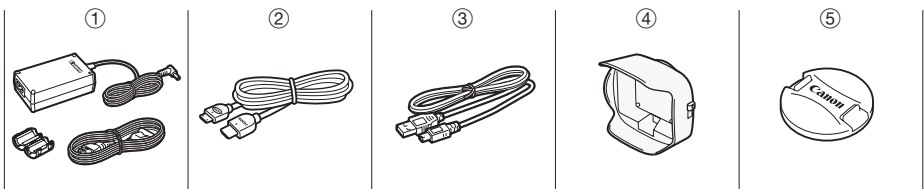



Table of Contents

06	Package contents
08	Onscreen Icons and Displays
12	Charging the Battery Pack
13	Basic Preparations
14	Using a Memory Card
15	Setting the Date/Time and Language
17	Shooting Video and Taking Photos
19	Playing Back Movies and Viewing Photos
21	Playback on a TV Screen
22	Saving Your Recordings
23	Abridged Specifications

About the Camcorder's Wi-Fi Functions

You can enjoy a variety of Wi-Fi functions with your camcorder. While these functions are beyond the scope of this Quick Guide, you can read the Wi-Fi Basic Setup Guide supplied with the camcorder to get you started. And you have the complete information in the full-version Instruction Manual (PDF file*).

About the Camcorder's PDF Instruction Manual

This guide will get you started and show you how to use the most basic functions of your camcorder to shoot video, take photos and play back your recordings (using the camcorder or connecting it to your TV). To learn more about the more advanced functions of your camcorder, to read important handling precautions and to consult the troubleshooting section if an error message is displayed, be sure to read the full-version Instruction Manual (PDF file*). In this Quick Guide, the  mark indicates reference page numbers in the PDF file.

* **Adobe® Reader®** 6 or later is required to view the PDF Instruction Manual.

Installing the Camcorder's Instruction Manual (PDF file)

- 1 **Insert the VIXIA CD-ROM into the computer's disc drive.**
The installer panel appears.
- 2 **In the installer panel, click [Instruction Manual of the Camcorder] and select your language.**
- 3 **When the installation is complete, click [OK], then [Exit].**
The installer will save the camcorder's Instruction Manual (PDF file) on the computer and will create a shortcut icon on the desktop for easy access.

introduction

Onscreen Icons and Displays

Recording movies

AUTO mode

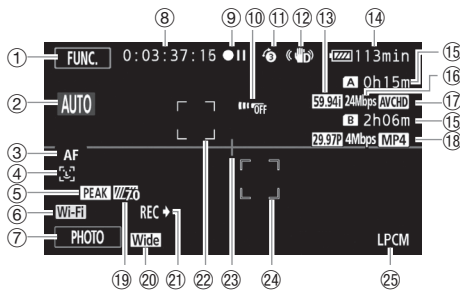

- ① Control button [FUNC.]: Open the FUNC. panel ([PDF](#) 31)
- ② Smart AUTO* ([18](#))
* Available only in **AUTO** mode.
- ③ Autofocus mode ([PDF](#) 54)
- ④ **Face detection:** You can have the camcorder automatically detect people's faces and use this information to adjust the focus and set the best exposure and color control settings for beautiful videos and photos. ([PDF](#) 55)
- ⑤ Peaking ([PDF](#) 53)
- ⑥ Wi-Fi Remote function ([PDF](#) 120)
- ⑦ Control button [PHOTO] - Take a photo ([17](#))
- ⑧ While recording/during playback: Time code (hours : minutes : seconds : frames)
- ⑨ Operation ([PDF](#) 156)
- ⑩ Remote sensor off ([PDF](#) 151)
- ⑪ **Pre-recording:** The camcorder will start recording video 3 seconds before you press **[START/STOP]**, so you do not miss important shooting opportunities. ([PDF](#) 88)
- ⑫ Image stabilizer ([PDF](#) 61)
- ⑬ Frame rate ([PDF](#) 48)
- ⑭ **Remaining battery time**
When the battery charge becomes low, replace the battery pack with a fully charged one.
- ⑮ Remaining recording time
[A]/[B] On the memory card
[A] / [B] Relay recording ([PDF](#) 47)
When there is no more space on the currently selected memory card, [End] will be displayed in red next to the memory card's icon.
- ⑯ Recording mode ([17](#))
- ⑰ Movie format ([15](#))
- ⑱ Frame rate, recording mode and movie format for dual recording ([PDF](#) 47)

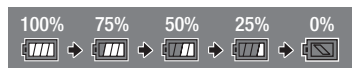

- ⑲ Zebra pattern ([PDF](#) 65)
- ⑳ Conversion lens (Wide attachment shown) ([PDF](#) 146)
- ㉑ Recording command ([PDF](#) 150)
- ㉒ Face detection frame ([PDF](#) 55)
- ㉓ **Level marker:** Display onscreen markers to check your composition and make sure horizontal or vertical lines do not appear crooked in your recordings. ([PDF](#) 146)
- ㉔ **Tracking frame:** Touch a moving subject on the screen to keep it clearly in focus at all times. ([PDF](#) 55)
- ㉕ Linear PCM audio ([PDF](#) 45)

Recording movies

[M] mode

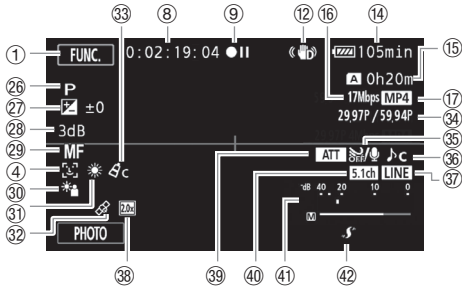



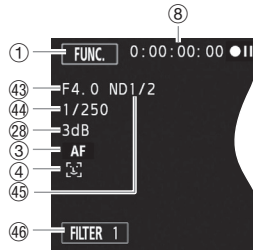

[CINEMA] mode

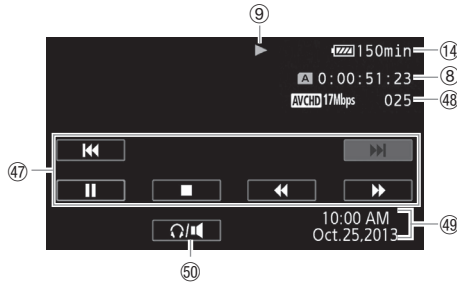

- 26 Recording program ([PDF](#) 63, 65, 70)
- 27 **Exposure compensation:** Correct the exposure manually for a picture darker/brighter than the one obtained using the automatic exposure set by the camcorder. ([PDF](#) 66)
- 28 AGC limit ([PDF](#) 62); Gain (during the [M Manual Exposure] recording program) ([PDF](#) 65)
- 29 Manual focus ([PDF](#) 52)
- 30 Backlight correction ([PDF](#) 67)
- 31 **White balance:** Change the setting so different lighting conditions do not affect the colors in your recordings and white objects look truly white. ([PDF](#) 68)
- 32 GPS ([PDF](#) 90)
- 33 Image effects ([PDF](#) 72)
- 34 Slow & fast motion recording (shooting frame rate/playback frame rate) ([PDF](#) 49)
- 35 Wind screen ([PDF](#) 81)
- 36 Audio scene select ([PDF](#) 79)
- 37 External audio input from the MIC terminal ([PDF](#) 84)
- 38 Digital tele-converter ([PDF](#) 60)
- 39 Microphone attenuator ([PDF](#) 146)
- 40 Directionality of the optional SM-V1 Surround Microphone ([PDF](#) 146)
- 41 **Audio level indicator:** Manually adjust the audio recording level. ([PDF](#) 81)
- 42 Mini advanced shoe ([PDF](#) 76)
- 43 Aperture value ([PDF](#) 63, 65)
- 44 Shutter speed ([PDF](#) 63, 65)
- 45 ND filter ([PDF](#) 146)
- 46 Control button [FILTER 1] - **Cinema-look filters:** Use cinema-look filters to create unique movies with distinctive looks. ([PDF](#) 50)







Playing movies (during playback)

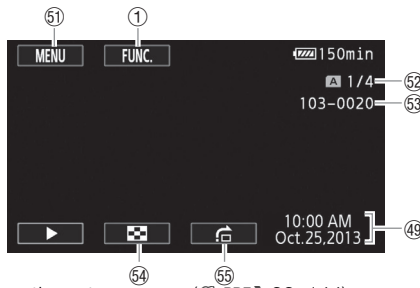

- ④⑦ Playback control buttons ( 20)
- ④⑧ Scene number
- ④⑨ Date/Time ( 33)
- ④⑩ Volume controls ( 96)

Viewing photos



- ⑤① Control button [MENU]: Open the setup menus ( 32, 144)
- ⑤② Current photo / Total number of photos
- ⑤③ File number ( 148)
- ⑤④ Control button [] - Return to the photo index screen ( 105)
- ⑤⑤ Control button [] - Photo jump ( 105)

step 1

Charging the Battery Pack

The camcorder can be powered with a battery pack or directly using the compact power adapter. When you use the compact power adapter, the power of the battery pack will not be consumed. Charge the battery pack before use.

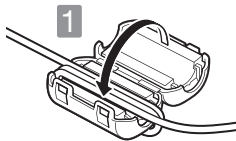

1 Attach the ferrite core to the compact power adapter cable.

- ① Attach the ferrite core about 6 cm (2.4 in.) from the plug end (the plug to be connected to the camcorder).
- ② Pass the cable through the center of the core and wrap it around the core, then close the unit until it clicks shut.
 - Attaching the ferrite core to the compact power adapter cable is necessary to suppress RF interference.

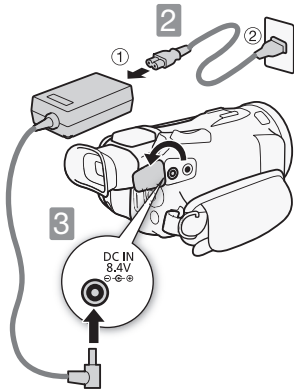

2 Connect the compact power adapter.

- ① Connect to the adapter.
- ② Plug into a power outlet.

3 Connect the camcorder.
Plug into the DC IN terminal.

4 Insert the battery pack.

- ① Press softly into the battery attachment unit.
- ② Slide up until it clicks in place.



Charging will start when the camcorder is turned off.

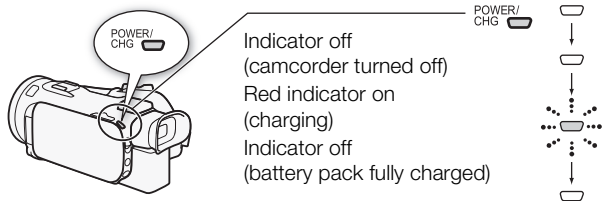

Charging times

Charging the supplied BP-820 Battery Pack will take approximately 4 hours 35 minutes. A fully charged battery pack will allow for 1 hour 40 minutes of recording under typical conditions or 4 hours 35 minutes of playback.*

* For movies recorded at 17 Mbps. Given times are approximate and vary according to recording mode and charging, recording or playback conditions.

See *Charging, Recording and Playback Times* (PDF 177) for details.

! IMPORTANT

- The battery pack will be charged only when the camcorder is off.
- Do not connect to the camcorder's DC IN terminal or to the compact power adapter any electrical equipment that is not expressly recommended for use with this camcorder.
- Do not connect the supplied compact power adapter to voltage converters or special power sources such as those on aircraft, DC-AC inverters, etc.

i NOTES

- We recommend charging the battery pack in temperatures between 10 °C and 30 °C (50 °F and 86 °F). If either the ambient temperature or the battery pack's temperature is outside the range of approx. 0 °C to 40 °C (32 °F to 104 °F), charging will not start.
- If remaining battery time is an issue, you can power the camcorder using the compact power adapter so the battery pack will not be consumed.
- Charged battery packs continue to discharge naturally. Therefore, charge them on the day of use, or the day before, to ensure a full charge.
- We recommend that you prepare battery packs to last 2 to 3 times longer than you think you might need.
- **USA and Canada only:** The Lithium ion/polymer battery that powers the product is recyclable. Please call 1-800-8-BATTERY for information on how to recycle this battery.



step 2

Basic Preparations

Before you begin, make basic adjustments and learn about a few of the frequently-used parts. See *Preparing the Camcorder* (PDF 24) for details. See *Handling Precautions* (PDF 169), *Cleaning* (PDF 173) for important information about how to take care of the touch screen.

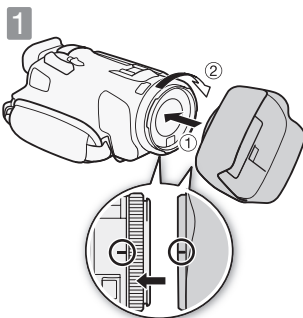

1 Attach the lens hood.

Place the lens hood on the front of the lens so that the groove on the lens hood is aligned with the bottom of the lens (①), and then turn the lens hood clockwise (②).

- Be careful not to deform the lens hood.
- Make sure that the lens hood is aligned with the thread.

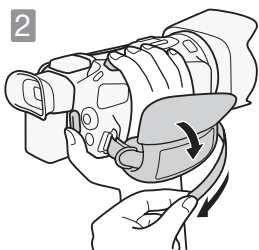

- 2** Fasten the grip belt.
Adjust it so you can reach the zoom rocker with your index finger, and **START/STOP** with your thumb.

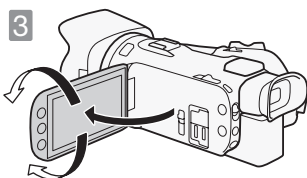



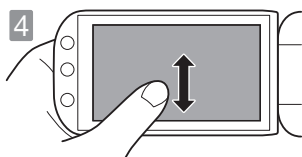

- 3** Open the OLED panel and adjust the angle.
- ① Rotate it up to 90 degrees down (for example, to record with your hand extended above a crowd).
 - ② Rotate it up to 180 degrees toward the lens (for example, to record video of yourself).
 - ③ If it is difficult to use the OLED screen, you can use the viewfinder, which can be tilted 45 degrees upward.



- 4** Become familiar with the touch screen.
- In addition to touching buttons to select items, you can also drag your finger across the screen for operations such as scrolling menus. While touching the screen, swipe your finger across the screen.
- Alternatively, you can use the joystick to navigate the menus.

step 3

Using a Memory Card

Use commercially available  SD,  SDHC (SD High Capacity) or  SDXC (SD eXtended Capacity) memory cards. Make sure you use a compatible memory card. See *Memory Cards Compatible for Use with the Camcorder* ( PDF) 35) for memory cards that can be used.

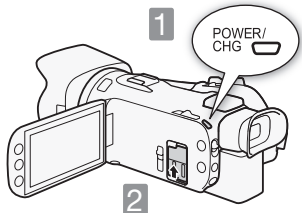

- 1** Turn off the camcorder.
Set to OFF. Make sure the indicator is off.
- 2** Open the double memory card slot cover.

3 Insert the memory card into one of the memory card slots and close the double memory card slot cover.

- ① Push the memory card into the memory card slot.
- ② Securely close the cover. Do not force it closed if the memory card is not correctly inserted.

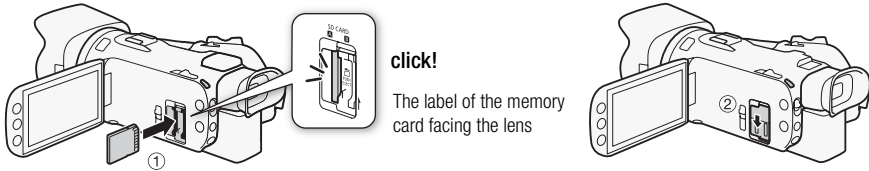

! IMPORTANT

- Memory cards have front and back sides that are not interchangeable. Inserting a memory card facing the wrong direction can cause a malfunction of the camcorder.
- For important information regarding the use of SDXC memory cards be sure to refer to *SDXC Memory Cards* (PDF 35).
- Initialize memory cards when you use them with this camcorder for the first time.
See *Initializing a Memory Card* (PDF 36) for details.

i NOTES

- **To remove the memory card:** Push the memory card once to release it. When the memory card springs out, pull it all the way out.

step 4

Setting the Date/Time and Language

When you turn on the camcorder for the first time, you will need to set the date and time before using the camcorder. You can also change the date format and time zone. (For your convenience, you can do so after changing the language to your preference.)

See *Changing the Time Zone* (PDF 34) for details.

1 Set to CAMERA.

When the internal clock is not set, the [Date/Time] screen will appear.

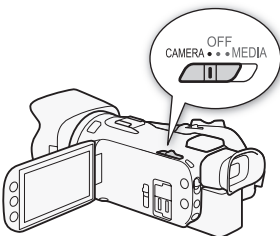

Setting the Date/Time and Language

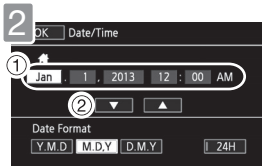

2 Change the date/time.

- 1 Touch a field you want to change.
- 2 Touch [▼] or [▲] to change the field.

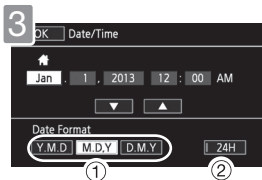

3 Select your preferred date/time format.

- 1 Touch one of the control buttons.
- 2 Touch to use 24-hour clock.

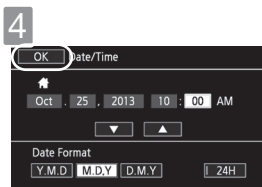

4 Touch [OK].

5 Select the language used for menus and onscreen displays.

You can select one of 27 languages to display the camcorder's menus and onscreen displays. Select the language of your preference using the menu.

See *Using the Menus* (PDF 31) for details.

[FUNC.]* > [MENU] > [Language] > [Language] > Desired language > [X]

* Only when performing the procedure in [CINEMA] mode.



English is the default language



NOTES

- If you changed the language by mistake, look for the menu option with the [Language] mark.

basic recording

Shooting Video and Taking Photos

In **AUTO** mode you can easily record movies and photos. You do not need to worry about any settings or menu options - the camcorder will select the most appropriate settings automatically.

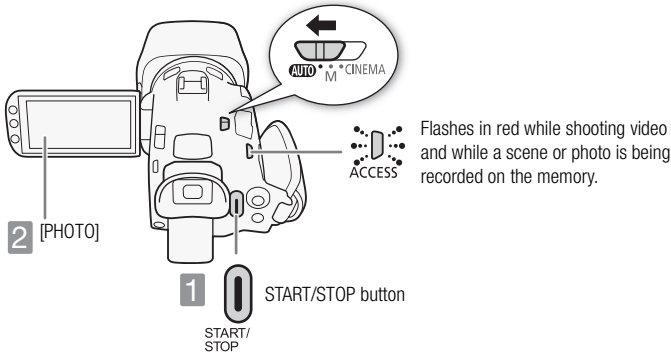

- 1 **Start recording movies.**
Press to start recording. Press again to pause the recording and record the video on the memory card as one scene.
- 2 **Take a photo.**
Touch [PHOTO] on the screen.

Using the Zoom to Frame the Subject

Use the zoom rocker or the onscreen zoom controls. To zoom out, zoom toward the **W** (wide angle) end. To zoom in, zoom toward the **T** (telephoto) end.

Touch [FUNC.] ➤ [ZOOM] to display the onscreen zoom controls

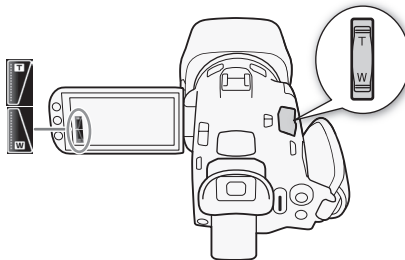
**Selecting Video Recording Options**

You can record movies in either AVCHD or MP4 format. Select AVCHD when you want to play back your movies with fantastic picture quality. Select MP4 when you want the versatility of uploading your movies to the Web or playing them back on devices such as smartphones and tablets.

[FUNC.] ➤ [MENU] ➤  ➤ [Movie Format] ➤ Desired movie format

You can also set the recording mode (video and audio quality). For AVCHD movies, you can select up to 28 Mbps, with two recording modes featuring linear PCM audio. For MP4 movies, you can record up to 35 Mbps.

[FUNC.] ➤ [MENU] ➤  ➤ [Recording Mode] ➤ Desired recording mode

See *Selecting the Movie Format (AVCHD/MP4)* ([PDF](#) 37) for details. See *Selecting the Video Quality* ([PDF](#) 45) for approximate recording times.

Using Wi-Fi to Record Movies with Your Smartphone or Tablet

You can use devices such as smartphones and tablets to remotely control the camcorder. While you view the camcorder's image on the device's screen, you can record movies.

See *Remote Operation Via the Wi-Fi Remote Application* ([PDF](#) 120) for details.

NOTES

- **Smart AUTO:** In **AUTO** mode, just point the camcorder and Smart AUTO will automatically select the best settings for your subject and the scene you want to use. One of 38 icons will appear depending on the characteristics of the subject, background, lighting conditions, etc.
See *Smart AUTO* ([PDF](#) 40) for details.
- **Intelligent IS:** In **AUTO** mode, the camcorder will automatically select the best IS setting for the situation.
See *Intelligent IS* ([PDF](#) 41) for details.
- Use **M** or **CINEMA** mode to access advanced functions and to change various settings up to your preferences.
See *Recording in M (Manual) Mode* ([PDF](#) 43), *CINEMA Mode and Cinema-Look Filters* ([PDF](#) 50) and all through the rest of the *Recording* chapter ([PDF](#) 38) for details.
- **About the zoom:** The camcorder features 20x optical zoom. When recording movies, you can also use the 400x digital zoom.
See *Digital Zoom* ([PDF](#) 145) for details.
- **About the zoom speed:**
 - Onscreen zoom controls: depends on where you touch within the zoom control.
 - Zoom rocker: variable speed. That is, the zoom speed depends on how you press the rocker: press gently for slower zooms; press harder for faster zooms. You can also change the zoom speed to one of three constant speeds.
 See *Zooming* ([PDF](#) 57) for details.
- In most situations, keep at least 60 cm (2 ft.) away from the subject. The minimum focusing distance at full wide angle is 1 cm (0.39 in.).

When you have finished recording

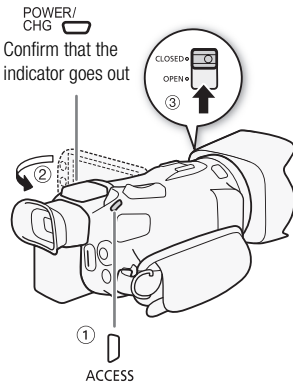

Make sure the camcorder has finished writing the scenes or photos on the memory before turning it off.

- ① Check that the indicator is off.
- ② Close the OLE panel.
- ③ Close the lens barrier.

basic playback

Playing Back Movies and Viewing Photos

Your recordings are conveniently organized in different index screens for AVCHD movies, MP4 movies and photos. You can change the index screen and easily find the recording you want to play back.

See *Playing Back Video* (📄PDF 95) and *Viewing Photos* (📄PDF 105) for details.

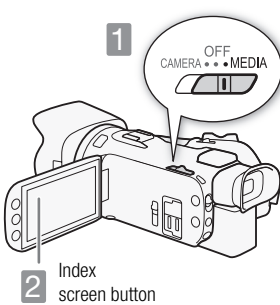

- 1 Set to MEDIA.

- 2 Change the index screen, if necessary.

Movies: Touch the index screen button ([A] AVCHD) to open the index selection screen. Next, touch the tab that indicates the memory card with the desired scene ([A] or [B]) and then touch the control button of the desired index screen.



3 Look for the scene or photo you want to play back. Drag your finger left or right for the next/previous index page.

4 Touch the desired scene or photo to play back.

Movies: The selected scene is played back. Playback continues until the end of the last scene in the index screen. Touch the screen during playback to display the playback controls.

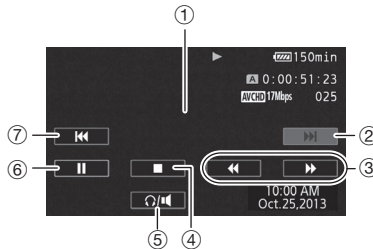

- ① Touch anywhere else to hide the playback controls
- ② Next scene
- ③ Fast playback* (touch again to increase the speed)
- ④ Stop
- ⑤ Volume controls
- ⑥ Pause (touch again to resume playback)
- ⑦ Beginning of the scene (double-tap to jump to the previous scene)

* In playback pause, these controls are replaced by the slow playback controls.

Photos: The selected photo is displayed in single photo view. Drag your finger left/right to browse through the photos one by one. Touch the screen to display the playback controls.

Using Wi-Fi to View Recordings

You can wirelessly upload recordings to an iOS device, view recordings from the Web browser of your smartphone or tablet, and more.

See *Wi-Fi Functions* (📄 PDF 117) for details.

! IMPORTANT

- You may not be able to play back with another device the movies you recorded on the memory card with this camcorder. In such case, play back the movies on the memory card using this camcorder.

i NOTES

- When playing back movies, depending on the recording conditions, you may notice brief stops in video or sound playback between scenes.

basic playback

Playback on a TV Screen

Connect your camcorder to a TV to enjoy your recordings with family and friends. Make sure the camcorder and TV are turned off before you start.

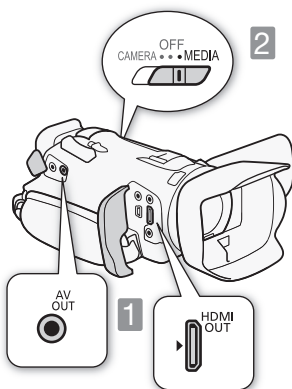

- 1** Connect the camcorder to the TV.
Select the appropriate connection according to the input terminals on your TV. The HDMI connection has higher picture quality (HD) than the composite video connection (SD).
- 2** Turn on the TV and then the camcorder.
Set to MEDIA.
- 3** Play back your movies or photos as described in the previous pages.

1 HDMI connection: All digital, high-definition connection; output only.

See *Connection Diagram* (PDF 102) for details about additional settings.

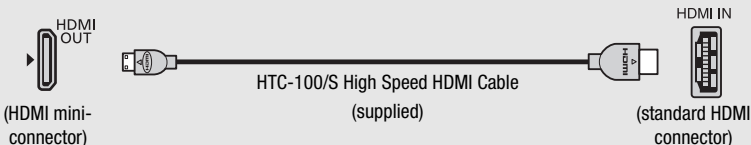

2 Composite video connection: Analog, standard-definition connection; output only.

See *Connection Diagram* ([PDF](#)) 102 for details about additional settings.

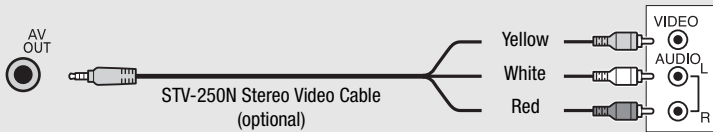

i NOTES

- The illustrations are for reference only. The layout of terminals on your TV may be different.
- We recommend powering the camcorder using the compact power adapter.
- Adjust the volume using the TV.
- When you play back 16:9 movies on standard TV sets with a 4:3 aspect ratio, the TV set will switch automatically to widescreen mode if it is compatible with the Video ID-1 system. Otherwise, change the aspect ratio of the TV manually.
See *[TV Type]* ([PDF](#)) 147 for details.

external connections

Saving Your Recordings

It is recommended that you periodically save your recordings.

Data Import Utility

- For AVCHD movies. Refer to the Software Guide (PDF file) of the supplied software for details about installing and using the software.

ImageBrowser EX

- For MP4 movies and photos. This software allows you to save and manage MP4 movies and photos. Refer to *Saving MP4 Movies and Photos Using ImageBrowser EX* ([PDF](#)) 109 for details about installing the software.

specifications

Abridged Specifications

The specifications given here are an **abridged version** of the full specifications of the camcorder. Be sure to read the full version of the instruction manual for the complete information.

See *Specifications* ( PDF) 181) for details.

Power supply (rated)

7.4 V DC (battery pack), 8.4 V DC (compact power adapter)

Power consumption

4.3 W (17 Mbps, AF on, OLED normal brightness)

Optional Accessories

Canon offers a wide range of optional accessories for your camcorder.

See *Optional Accessories* ( PDF) 175) for details.

 NOTES

- When using the optional GP-E2 GPS Receiver, GPS information added to AVCHD movies cannot be deleted with the camcorder or supplied software.

Use of genuine Canon accessories is recommended.

This product is designed to achieve excellent performance when used with genuine Canon accessories. Canon shall not be liable for any damage to this product and/or accidents such as fire, etc., caused by the malfunction of non-genuine Canon accessories (e.g., a leakage and/or explosion of a battery pack). Please note that this warranty does not apply to repairs arising out of the malfunction of non-genuine Canon accessories, although you may request such repairs on a chargeable basis.

This mark identifies genuine Canon video accessories. When you use Canon video equipment, we recommend Canon-brand accessories or products bearing the same mark.



USA

CANON CONSUMER DIGITAL VIDEO EQUIPMENT LIMITED WARRANTY FOR THE UNITED STATES

The limited warranty set forth below is given by Canon U.S.A., Inc. ("Canon USA") with respect to Canon Consumer Digital Video Equipment (the "Equipment") purchased in the United States. This limited warranty is only effective upon presentation of your Bill of Sale or other proof of purchase.

The Equipment is warranted under normal, non-commercial, personal use, against defective materials or workmanship as follows:

Parts: Defective parts will be exchanged for new parts or comparable rebuilt parts for a period of ONE YEAR from the date of original purchase, except for a defective Video Head, which will be exchanged for a period of three months from the date of purchase.

Labor: For a period of ONE YEAR from the date of original purchase, labor will be provided free of charge by our factory service centers or designated service facilities located in the United States.

When returning Equipment under this warranty, you must pre-pay the shipping charges, and you must enclose the Bill of Sale or other proof of purchase with a complete explanation of the problem. During the ONE-YEAR warranty period, repairs will be made and the Equipment will be return-shipped to you free of charge. For repairs after the warranty period is over, you will be given an estimate of the cost of repair and an opportunity to approve or disapprove of the repair expense before it is incurred. If you approve, repairs will be made and the Equipment will be return-shipped to you. (Shipping charges apply). If you disapprove, we will return-ship the equipment at no charge to you.

Non-Canon brand peripheral equipment and software which may be distributed with, or factory loaded on, the Equipment, are sold "AS IS" without warranty of any kind by Canon USA, including any implied warranty regarding merchantability or fitness for a particular purpose. The sole warranty with respect to such non-Canon brand items is given by the manufacturer or producer thereof. If the Equipment contains a hard disk drive, Canon USA recommends that data stored on that drive be duplicated or backed up to prevent its loss in the event of failure or other malfunction of such drive.

Canon USA shall have no responsibility under this limited warranty for use of the Equipment in conjunction with incompatible peripheral equipment and incompatible software.

In order to obtain warranty service, contact the authorized Canon retail dealer from whom you purchased the Equipment or call the CANON INFORMATION CENTER AT 1-800-OK-CANON). You will be directed to the nearest service facility for your Equipment.

This Limited Warranty covers all defects encountered in normal use of the Equipment and does not apply in the following cases:

- A) Loss or damage to the Equipment due to abuse, mishandling, accident, improper maintenance, or failure to follow operating instructions;
- B) If the Equipment is defective as a result of leaking batteries, sand, dirt or water damage;
- C) If defects or damages are caused by the use of unauthorized parts or by service other than by Canon USA's factory service centers or authorized service facilities;
- D) If the Equipment is used for commercial or industrial use.

This Limited Warranty does not cover cabinet (exterior finish), video cassette tape, head cleanings, nor does it apply to Equipment purchased outside the United States. This warranty does not cover units sold to rental firms, military operations, hotels, schools, hospitals or for other commercial, industrial, or institutional applications. These uses are covered only by such specific warranty as Canon may issue with such sales.

This Limited Warranty does not apply to accessories or consumables for the Equipment, which are sold "AS IS", without warranty of any kind by Canon USA. Please retain this warranty card and your Bill of Sale as a permanent record of your purchase. This card is most important in order to be sure you are contacted right away should there be a safety inspection, modification or product recall under applicable laws or regulations.

NO IMPLIED WARRANTY, INCLUDING MERCHANTABILITY AND FITNESS FOR A PARTICULAR PURPOSE APPLIES TO THIS EQUIPMENT AFTER THE APPLICABLE PERIOD OF EXPRESS WARRANTY OR GUARANTY, EXCEPT AS MENTIONED ABOVE, GIVEN BY ANY PERSON, FIRM OR CORPORATION WITH RESPECT TO THIS EQUIPMENT SHALL BIND THE UNDERSIGNED (SOME STATES DO NOT ALLOW LIMITATIONS ON HOW LONG AN IMPLIED WARRANTY LASTS, SO THE ABOVE LIMITATION OR EXCLUSION MAY NOT APPLY TO YOU). CANON USA SHALL NOT BE LIABLE FOR LOSS OF REVENUES OR PROFITS, EXPENSE FOR SUBSTITUTE EQUIPMENT OR SERVICE, STORAGE CHARGES, LOSS OR CORRUPTION OF DATA, INCLUDING WITHOUT LIMITATION, LOSS OR CORRUPTION OF DATA STORED ON THE EQUIPMENT'S HARD DRIVE, OR ANY OTHER SPECIAL, INCIDENTAL OR CONSEQUENTIAL DAMAGES CAUSED BY THE USE, MISUSE OR INABILITY TO USE THE EQUIPMENT, REGARDLESS OF THE LEGAL THEORY ON WHICH THE CLAIM IS BASED, AND EVEN IF CANON USA HAS BEEN ADVISED OF THE POSSIBILITY OF SUCH DAMAGES. NOR SHALL RECOVERY OF ANY KIND AGAINST CANON USA BE GREATER THAN THE PURCHASE PRICE OF THE EQUIPMENT SOLD BY CANON USA AND CAUSING THE ALLEGED DAMAGE. WITHOUT LIMITING THE FOREGOING, YOU ASSUME ALL RISK AND LIABILITY FOR LOSS, DAMAGE OR INJURY TO YOU AND YOUR PROPERTY AND TO OTHERS AND THEIR PROPERTY ARISING OUT OF USE, MISUSE OR INABILITY TO USE THE EQUIPMENT NOT CAUSED DIRECTLY BY THE NEGLIGENCE OF CANON USA. (SOME STATES DO NOT ALLOW THE EXCLUSION OR LIMITATION OF INCIDENTAL OR CONSEQUENTIAL DAMAGES, SO THE ABOVE LIMITATION MAY NOT APPLY TO YOU). THIS WARRANTY SHALL NOT EXTEND TO ANYONE OTHER THAN THE ORIGINAL PURCHASER OF THIS EQUIPMENT OR THE PERSON FOR WHOM IT WAS PURCHASED AS A GIFT.

This warranty gives you specific legal rights, and you may also have other rights which vary from state to state.
CANON U.S.A., INC.

CANADA

CANON CONSUMER DIGITAL VIDEO EQUIPMENT LIMITED WARRANTY

The limited warranty set forth below is given by Canon Canada Inc. ("Canon Canada") with respect to Canon Consumer Digital Video Equipment (the "Equipment") purchased in Canada. This limited warranty is only effective upon presentation of a bill of sale or other proof of purchase for this Equipment to a Canon Service Facility when repairs are required.

The Equipment is warranted under normal, non-commercial, personal use, against defective materials or workmanship as follows:

Parts: Defective parts will be exchanged for new parts or, at Canon Canada's option, comparable rebuilt parts for a period of one year from the date of original purchase, except Video Heads which will be exchanged for a period of 3 months from the date of purchase.

Labour: For a period of one year from the date of original purchase, labour will be provided free of charge by our Canon Service Facilities in Canada.

This limited warranty covers all defects except where:

(a) The loss or damage to the product results from:

- i) accident, natural disaster, mishandling, abuse, neglect, unauthorized product modification or failure to follow instructions contained in the instruction manual;
- ii) the use of accessories, attachments, products, supplies, parts or devices with the Equipment that do not conform to Canon specifications or that cause abnormally frequent service problems;
- iii) repairs or services performed by any party other than a Canon Service Facility;
- iv) defective batteries or any exposure to water, sand or dirt;
- v) shipping (claim must be presented to the shipper);

(b) Any serial number on the video equipment is altered or removed.

(c) The Equipment is used for commercial, professional or industrial purposes.

This limited warranty does not cover the cabinet (exterior finish) of the Equipment, media, nor does it apply to Equipment purchased outside Canada.

If the Equipment contains a hard disk drive, Canon Canada recommends that data stored on that drive be duplicated or backed up to prevent its loss in the event of a failure or other malfunction of such drive.

TO OBTAIN WARRANTY SERVICE

Ship your Equipment in its original carton, box or equivalent, properly packed, fully insured with shipping charges prepaid, together with a copy of your bill of sale or other proof of purchase and a description of the problem to any of the Canon Service Facilities in Canada.

LIMITATIONS

Except as otherwise required by applicable legislation, this warranty is in lieu of all other warranties, conditions, guarantees or representations, express or implied, statutory or otherwise, relative to the Equipment, including implied warranties or conditions of merchantability or fitness for a particular purpose.

Canon Canada assumes no liability for special, consequential or incidental damages, loss or corruption of data including, without limitation, data stored on the hard disk drive of the Equipment or loss that may arise, whether on account of negligence or otherwise, from the use, misuse or inability to use the Equipment (including loss of profit, revenue, media or enjoyment) or from failure to conform to any express or implied warranties, conditions, guarantees or representations. Any recovery under this limited warranty shall not exceed the purchase price of the equipment. Canon Canada does not assume or authorize any other person to assume for Canon Canada any other liability with respect to this equipment.

This warranty does not extend to any person other than the original purchaser of the Equipment or the person for whom it was purchased as a gift and states your exclusive remedy.

NOTICE TO CONSUMER

If you plan to take important videos or if the product has not been used for some time, please check all functions with the instruction book before using it.



USA**CANON U.S.A., INC. NEW JERSEY OFFICE**

100 Jamesburg Road, Jamesburg, NJ 08831 USA

CANON U.S.A., INC. CHICAGO OFFICE

100 Park Blvd., Itasca, IL 60143 USA

CANON U.S.A., INC. LOS ANGELES OFFICE

15955 Alton Parkway, Irvine, CA 92618 USA

CANON U.S.A., INC. HONOLULU OFFICE

210 Ward Avenue, Suite 200, Honolulu, HI 96814 USA

- ❖ If you have any questions, call the Canon U.S.A. Information Center toll-free at 1-800-828-4040 (USA only).

CANADA**CANON CANADA INC.**

6390 Dixie Road, Mississauga, ON L5T 1P7

- ❖ If you have any questions, call the Canon Canada Information Center toll free (in Canada only) at 1-800-OK-CANON (1-800-652-2666).
- ❖ Si vous avez des questions, veuillez téléphoner 1-800-OK-CANON (1-800-652-2666, sans frais au Canada seulement).

MÉXICO**CANON MEXICANA, S DE RL DE CV**

Bldv. Manuel Ávila Camacho No. 138, Piso 17

Col. Lomas de Chapultepec, C.P. 11000 México, D.F., México

CANON U.S.A., INC. NEW JERSEY OFFICE

100 Jamesburg Road, Jamesburg, NJ 08831 USA

**CENTRO Y
SURAMÉRICA****CANON LATIN AMERICA, INC.**

One Canon Park, Melville, NY 11747 USA

ASIA**CANON HONGKONG COMPANY LTD.**

19/F, The Metropolis Tower, 10 Metropolis Drive,

Hunghom, Kowloon, Hong Kong

Tel: +852 3191 2333, Fax: +852 2428 3963

-
- Visit your local Canon Web site to download the latest version of this Quick Guide. For support concerning the supplied software, contact your local Canon Service Center.
 - Consultez le site Web Canon de votre pays pour télécharger la version la plus récente de ce guide rapide. Pour toute assistance concernant le logiciel fourni, contactez votre centre de service Canon local.
 - Para descargar la última versión de este guía breve visite nuestro sitio web local de Canon. Para obtener asistencia técnica relacionada con el suministrado, constante con su Centro de Servicio Canon.