

Canon EF LENS

EF70-300mm f/4.5-5.6 DO IS USM



DIFFRACTIVE OPTICS
IMAGE STABILIZER
ULTRASONIC

ENG
Instruction

Thank you for purchasing a Canon product.

The Canon EF70-300mm f/4.5-5.6 DO IS USM is a high-performance, compact telephoto zoom lens for Canon EOS cameras, equipped with DO (diffractive optics) lens elements and an Image Stabilizer.

Innovative DO optical elements combine the benefits of fluoride elements and aspheric elements, and contribute to achieving high quality and compactness.

- "DO" stands for Diffractive Optics.
- "IS" stands for Image Stabilizer.
- "USM" stands for Ultrasonic Motor.

Conventions used in this instruction



Warning to prevent lens or camera malfunction or damage.



Supplementary notes on using the lens and taking pictures.

Features

1. DO elements adjust for chromatic aberrations that tend to occur with telephoto zoom lenses, and contribute to achieving an innovative compactness with outstanding image quality.
2. The Image Stabilizer gives the equivalent effect of a shutter speed three stops faster*.
3. The zoom ring can be fixed to keep the lens at the shortest point.
4. Ultrasonic motor (USM) for quick and quiet autofocus.
5. Manual focusing is available after the subject comes into focus in autofocus mode (ONE SHOT AF).
6. A truly round aperture hole results in a nicer background blur.

* Based on $[1/\text{focal length}]$ second. Generally, it requires a shutter speed $[1/\text{focal length}]$ second or faster to prevent camera shake.

Safety Precautions

Safety Precautions

- **Do not look at the sun or a bright light source through the lens or camera.** Doing so could result in loss of vision. Looking at the sun directly through the lens is especially hazardous.
- **Whether it is attached to the camera or not, do not leave the lens under the sun without the lens cap attached.** This is to prevent the lens from concentrating the sun's rays, which could cause a fire.

Handling Cautions

- **If the lens is taken from a cold environment into a warm one, condensation may develop on the lens surface and internal parts.** To prevent condensation in this case, first put the lens into an airtight plastic bag before taking it from a cold to warm environment. Then take out the lens after it has warmed gradually. Do the same when taking the lens from a warm environment into a cold one.
- Do not leave the lens in excessive heat such as in a car in direct sunlight. **High temperatures can cause the lens to malfunction.**

This device complies with Part 15 of the FCC Rules. Operation is subject to the following two conditions: (1) This device may not cause harmful interference, and (2) this device must accept any interference received, including interference that may cause undesired operation.

Do not make any changes or modifications to the equipment unless otherwise specified in the instructions. If such changes or modifications should be made, you could be required to stop operation of the equipment.

This equipment has been tested and found to comply with the limits for a class B digital device, pursuant to part 15 of the FCC Rules. These limits are designed to provide reasonable protection against harmful interference in a residential installation. This equipment generates, uses and can radiate radio frequency energy and, if not installed and used in accordance with the instructions, may cause harmful interference to radio communications.

However, there is no guarantee that interference will not occur in a particular installation. If this equipment does cause harmful interference to radio or television reception, which can be determined by turning the equipment off and on, the user is encouraged to try to correct the interference by one or more of the following measures:

- Reorient or relocate the receiving antenna.
- Increase the separation between the equipment and receiver.
- Consult the dealer or an experienced radio/TV technician for help.

This Class B digital apparatus complies with Canadian ICES-003.

Shooting Precautions

If a very bright spotlight like a mercury lamp is photographed in a dark place with this lens, a halo of light may occasionally appear around the light source because of the DO elements.

Nomenclature

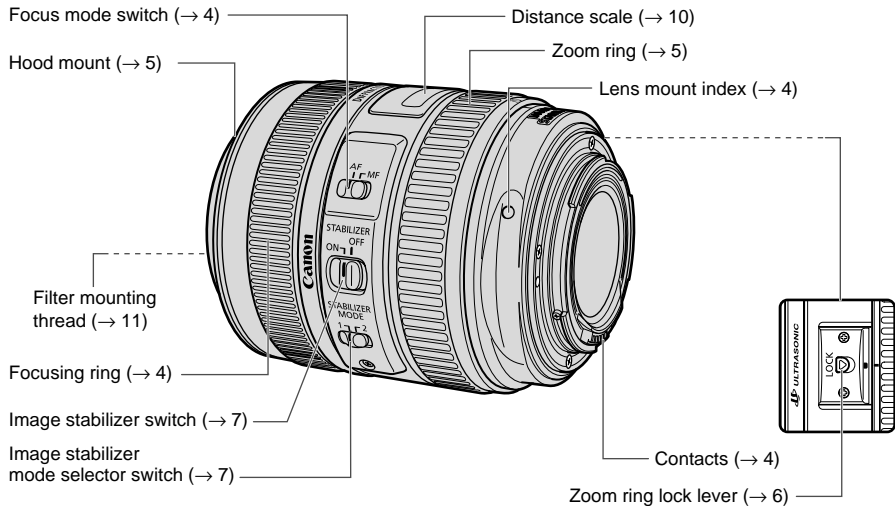

For detailed information, reference page numbers are provided in parentheses (→ **).

1. Mounting and Detaching the Lens

See your camera's instructions for details on mounting and detaching the lens.

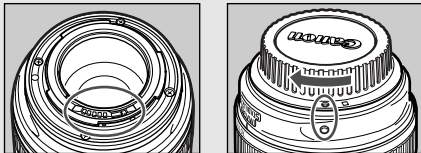

- After detaching the lens, place the lens with the rear end up to prevent the lens surface and electrical contacts from getting scratched.
- If the contacts get soiled, scratched, or have fingerprints on them, corrosion or faulty connections can result. The camera and lens may not operate properly.
- If the contacts get soiled or have fingerprints on them, clean them with a soft cloth.
- If you remove the lens, cover it with the dust cap. To attach it properly, align the lens mount index and the ○ index of the dust cap as shown in the diagram, and turn clockwise. To remove it, reverse the order.

2. Setting the Focus Mode

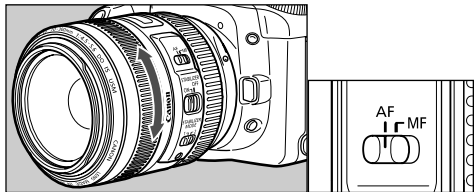

To shoot in autofocus (AF) mode, set the focus mode switch to AF.

To use only manual focusing (MF), set the focus mode switch to MF, and focus by turning the focusing ring. The focusing ring always works, regardless of the focus mode.



After autofocus in ONE SHOT AF mode, focus manually by pressing the shutter button halfway and turning the focusing ring. (Full-time manual focus)

3. Zooming

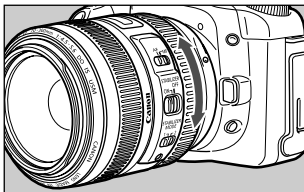

To zoom, turn the zoom ring.

- ⚠ Be sure to finish zooming before focusing. Zooming after focusing can affect the focus.

4. Hood

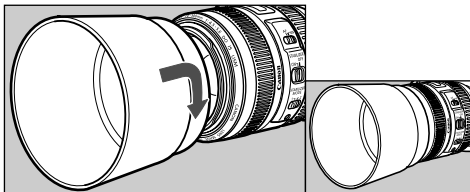

The ET-65B hood can keep unwanted light out of the lens, and also protects the front of the lens from rain, snow, and dust.

Attach and align the hood to the hood mount on the front of the lens, and turn the hood as shown by the arrow to secure it.

The hood can be reverse-mounted on the lens for storage.

- ⚠ • Part of the picture may be blocked if the hood is not attached properly.
- When attaching or detaching the hood, grasp the base of the hood to turn it. To prevent deformation, do not grasp the rim of the hood to turn it.

5. Fixing the Zoom Ring

The zoom ring can be fixed to keep the lens at the shortest point. This function is convenient for carrying a camera on a strap because it prevents the lens from extending.

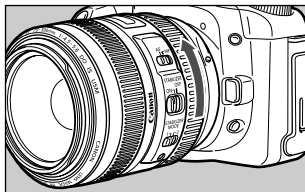
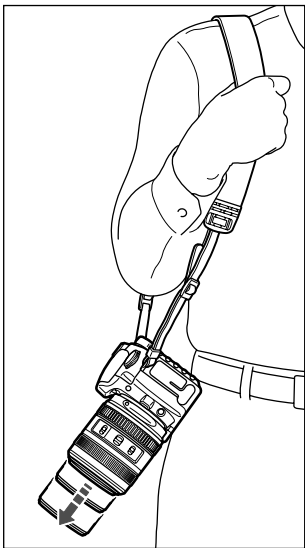

1 Turn the zoom ring to the widest position (70mm).

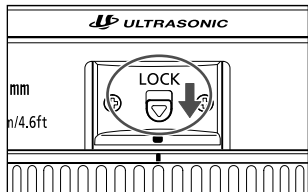

2 Slide the zoom ring lock lever in the direction indicated by the arrow.

- To release the zoom ring, slide the zoom ring lock lever in the direction opposite to the arrow.



The zoom ring can only be locked at maximum wide angle.

6. Image Stabilizer Settings

You can use the image stabilizer in AF or MF mode.

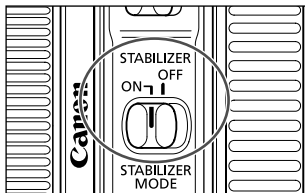

1 Set the STABILIZER switch to ON.

- If you are not going to use the image stabilizer function, set the switch to OFF.

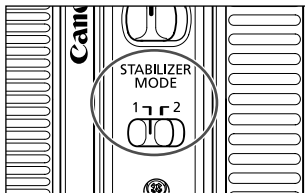

2 Select the stabilizer mode.

- MODE 1: Corrects vibrations in all directions. It is mainly effective for shooting still subjects.
- MODE 2: It compensates for vertical camera shake during following shots in a horizontal direction, and compensates for horizontal camera shake during following shots in a vertical direction.

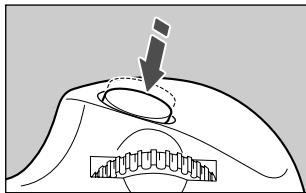

3 When you press the shutter button halfway, the Image Stabilizer will start operating.

- Make sure the image in the viewfinder is stable, then press the shutter button the rest of the way down to take the picture.

7. Tips on Using the Image Stabilizer

The image stabilizer in this lens is effective for hand-held shots under the following conditions.

● MODE 1



ON

OFF

- In semi-darkened areas such as indoors or outdoors at night.
- In locations where flash photography is prohibited, such as art museums and theater stages.
- In situations where your footing is uncertain.
- In situations where fast shutter settings cannot be used.

● MODE 2



ON

OFF

- When panning subjects in motion.

Tips on Using the Image Stabilizer



- The Image Stabilizer cannot compensate for a blurred shot caused by a subject that moved.
- Set the STABILIZER switch to OFF when you are taking pictures using the Bulb setting (long exposures). If the STABILIZER switch is set to ON, the image stabilizer function may introduce errors.
- The Image Stabilizer might not be fully effective in the following cases:
 - You shoot while riding on a bumpy road.
 - You move the camera dramatically for a panning shot in Mode 1.
 - You shoot using techniques other than following shots in Mode 2.
- The Image Stabilizer consumes more power than normal shooting, so fewer shots can be taken if you use the function.
- The image stabilizer operates for about two seconds even when your finger is off the shutter button. Do not remove the lens while the stabilizer is in operation. This will cause a malfunction.
- With the EOS-1V/HS, 3, ELAN 7E/ELAN 7/30/33, ELAN 7NE/ELAN 7N/30V/33V, ELAN II/ELAN IIE/50/50E, REBEL 2000/300, IX, and D30, the Image Stabilizer will not work during self-timer operation.



- When you use a tripod, the Image Stabilizer should be turned off to save battery power.
- The stabilizer is equally effective for hand-held photography and photography with a monopod.
- The image stabilizer function also operates when the lens is used with an Extension Tube EF12 II or EF25 II.
- Pictures may look distorted after being taken depending on the camera, but this doesn't affect shooting.
- If you set the camera's Custom Function to change the assigned button to operate the AF, the Image Stabilizer will operate when you press the newly assigned AF button.

8. Infinity Compensation Mark

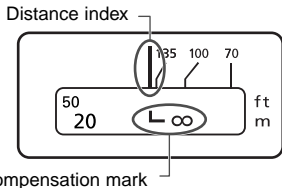

To compensate for shifting of the infinity focus point that results from changes in temperature. The infinity position at normal temperature is the point at which the vertical line of the L mark is aligned with the distance indicator on the distance scale.

- For accurate manual focusing on subjects at infinity distance, look through the viewfinder while rotating the focusing ring.

9. Infrared Index

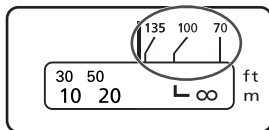

The infrared index corrects the focus setting when using monochrome infrared film. Focus on the subject manually, then adjust the distance setting by moving the focusing ring to the corresponding infrared index mark.

- Some EOS cameras cannot use infrared film. See the instructions for your EOS camera.

- The infrared index position is based on a wavelength of 800 nm.
- The compensation amount differs depending on the focal length. Use the indicated focal length as a guide when setting the compensation amount.
- Be sure to observe the manufacturer's instructions when using infrared film.
- Use a red filter when you take the picture.

10. Filters (Sold separately)

You can attach filters to the filter mounting thread on the front of the lens.



- If you need a polarizing filter, use the Canon Circular Polarizing Filter (58mm).
- To adjust the polarizing filter, first remove the lens hood.

11. Extension Tubes (Sold separately)

You can attach Extension Tube EF12 II or EF25 II for magnified shots. The shooting distance and magnification are shown below.

| | | Camera-to-Subject Distance (mm) | | Magnification | |
|---------|-------|---------------------------------|------|---------------|-------|
| | | Near | Far | Near | Far |
| EF12 II | 70mm | 478 | 616 | 0.23× | 0.17× |
| | 300mm | 1170 | 7626 | 0.26× | 0.04× |
| EF25 II | 70mm | 354 | 398 | 0.46× | 0.38× |
| | 300mm | 1024 | 3890 | 0.35× | 0.09× |



Manual focusing is recommended for accurate focusing.

12. Close-up Lenses (Sold separately)

Attaching a 250D or 500D (58mm) Close-up Lens enables close-up photography.

Compatibility with Close-up Lenses is as follows.

- Close-up Lens 250D:
Can be used at the 70mm end (magnification 0.29x - 1.18x)
- Close-up Lens 500D:
Can be used (magnification 0.14x - 0.65x)



Manual focusing is recommended for accurate focusing.

Specifications

| | |
|---|--|
| Focal Length & Max. Aperture | 70 – 300 mm, f/4.5 – 5.6 |
| Lens Construction | 18 elements in 12 groups |
| Min. Aperture | f/32 – 40* |
| Angle of View | Diagonal: 34° – 8°15' Vertical: 19°30' – 4°35' Horizontal: 29° – 6°50' |
| Min. Focusing Distance | 1.4 m / 4.6 ft. |
| Max. Magnification & Field of view | 0.19 × (at 300 mm), 432 × 650 – 123 × 183 mm / 16.8 × 25.4 – 4.8 × 7.1 inch (at 1.4 m) |
| Filter Diameter | 58 mm |
| Max. Diameter & Length | 82.4 × 99.9 mm / 3.2 × 3.9 inch |
| Weight | 720 g / 25.2 oz |
| Lens Hood | ET-65B |
| Lens Cap | E-58U/E-58 II |
| Case | LP1116 |

* This figure is for models that display apertures by 1/3 increment. For models that display apertures by 1/2 increment, it is f/32-38.

- The lens length is measured from the mount surface to the front end of the lens. Add 21.5 mm to include the E-58U lens cap and dust cap, and 24.2 mm for the E-58 II.
- The size and weight listed are for the lens only, except as indicated.
- The EF1.4X II/EF2X II extenders cannot be used with this lens.
- Aperture settings are specified on the camera. The camera automatically compensates for variations in the aperture setting when the camera is zoomed in or out.
- All data listed is measured according to Canon standards.
- Product specifications and appearance are subject to change without notice.

Canon