

Canon EF LENS

EF11-24mm f/4L USM



 **ULTRASONIC**

ENG
Instructions

Thank you for purchasing a Canon product.

Canon's EF11-24mm f/4L USM is a high-performance ultra-wide angle zoom lens, for use with EOS cameras.

- "USM" stands for Ultrasonic Motor.

Features

1. Use of super UD lens elements, UD lens elements, and two types of aspherical lens elements giving superior definition.
2. SWC (Subwavelength Structure Coating) and ASC (Air Sphere Coating) are utilized to significantly reduce occurrences of flare and ghost created by quite large incident angles of light.
3. Using a fluorine coating on the foremost and rearmost lens surfaces allows adhered dirt to be removed more easily than before.
4. Ultrasonic motor (USM) for fast, quiet autofocus.
5. Manual focusing is available after the subject comes into focus in autofocus mode (ONE SHOT AF).
6. Circular aperture for producing beautiful softfocus images.
7. Tight seal structure provides excellent dustproof and drip-proof performance. However, it is unable to provide complete protection from dust and moisture.

Safety Precautions

Handling Cautions

- If the lens is taken from a cold environment into a warm one, condensation may develop on the lens surface and internal parts. To prevent condensation in this case, first put the lens into an airtight plastic bag before taking it from a cold to warm environment. Then take out the lens after it has warmed gradually. Do the same when taking the lens from a warm environment into a cold one.
- Do not leave the lens in excessive heat such as in a car in direct sunlight. **High temperatures can cause the lens to malfunction.**

Usage Precautions

- When using this lens, please check the Canon website for the latest camera firmware. If the camera's firmware is not the latest version, be sure to update to the latest firmware.
- For details on updating firmware, please check the Canon website.

Safety Precautions

- **Do not look at the sun or a bright light source through the lens or camera.** Doing so could result in loss of vision. Looking at the sun directly through the lens is especially hazardous.
- **Whether it is attached to the camera or not, do not leave the lens under the sun without the lens cap attached.** This is to prevent the lens from concentrating the sun's rays, which could cause a fire.
- The EF11-24mm f/4L USM features a large diameter front lens element. Please be careful because this large front section will extend past the bottom of some cameras.

Conventions used in this instruction



Warning to prevent lens or camera malfunction or damage.



Supplementary notes on using the lens and taking pictures.

Precautions for Shooting

- If dirt or dust adheres to the surface of the front lens element, it can easily appear in images due to the lens's short focal length. In order to avoid this, please remove dirt or dust from the surface of the front lens element by using a commercially available air dust blower.
- Since this lens has a wide angle of view, light from bright light sources, such as the sun, can easily enter the image area. Please do not look at bright light sources using the camera's viewfinder.
- Similarly, flare and ghost will occur when bright light sources appear in the image area, depending on shooting conditions. In order to prevent flare and ghost, we suggest shooting places such as shaded areas so that bright light does not enter the lens.

Safety Precautions

This device complies with Part 15 of the FCC Rules.

Operation is subject to the following two conditions: (1) This device may not cause harmful interference, and (2) this device must accept any interference received, including interference that may cause undesired operation.

Do not make any changes or modifications to the equipment unless otherwise specified in the instructions. If such changes or modifications should be made, you could be required to stop operation of the equipment.

This equipment has been tested and found to comply with the limits for a class B digital device, pursuant to part 15 of the FCC Rules. These limits are designed to provide reasonable protection against harmful interference in a residential installation. This equipment generates, uses and can radiate radio frequency energy and, if not installed and used in accordance with the instructions, may cause harmful interference to radio communications.

However, there is no guarantee that interference will not occur in a particular installation. If this equipment does cause harmful interference to radio or television reception, which can be determined by turning the equipment off and on, the user is encouraged to try to correct the interference by one or more of the following measures:

- Reorient or relocate the receiving antenna.
- Increase the separation between the equipment and receiver.
- Connect the equipment into an outlet on a circuit different from that to which the receiver is connected.
- Consult the dealer or an experienced radio/TV technician for help.

CAN ICES-3 (B) / NMB-3 (B)

Nomenclature

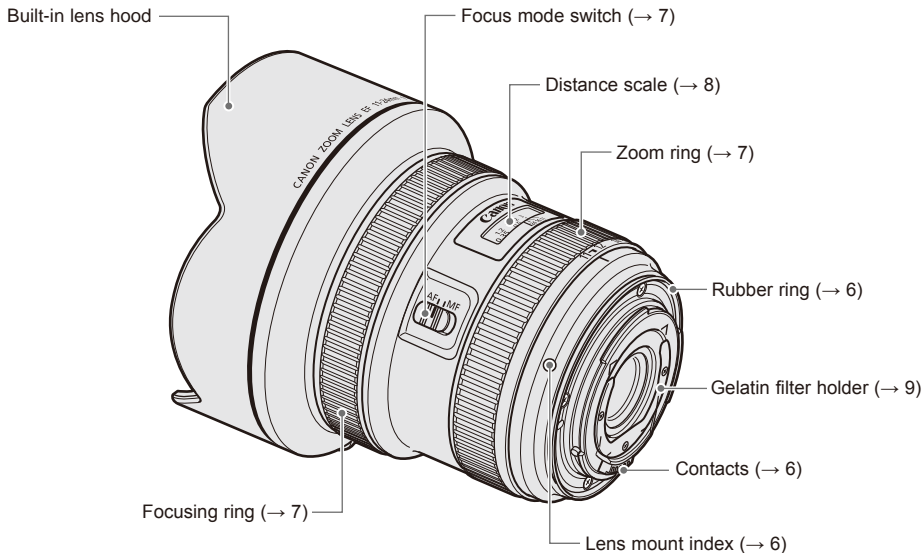



- For detailed information, reference page numbers are provided in parentheses (→ **).

1. Mounting and Detaching the Lens

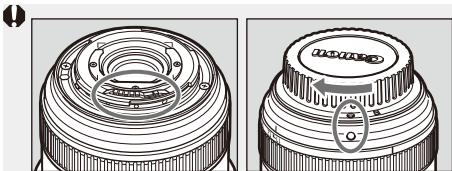
See your camera's instructions for details on mounting and detaching the lens.



- After detaching the lens, place the lens with the rear end up to prevent the lens surface and contacts from getting scratched.
- If the contacts get soiled, scratched, or have fingerprints on them, corrosion or faulty connections can result. The camera and lens may not operate properly.
- If the contacts get soiled or have fingerprints on them, clean them with a soft cloth.
- If you remove the lens, cover it with the dust cap. To attach it properly, align the lens mount index and the  index of the dust cap as shown in the diagram, and turn clockwise. To remove it, reverse the order.

 The lens mount has a rubber ring for enhanced dust- and water-resistance. The rubber ring may cause slight abrasions around the camera's lens mount, but this will not cause any problems. If the rubber ring becomes worn, it is replaceable by a Canon Service Center at cost.

 Please be careful when laying the lens sideways. The lens may roll and fall, resulting in injury.

2. Setting the Focus Mode

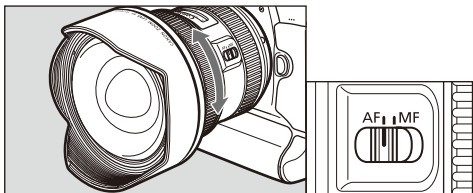

To shoot in autofocus (AF) mode, set the focus mode switch to AF.

To shoot in manual focus (MF) mode, set the focus mode switch to MF, and focus by turning the focusing ring.

The focusing ring always works, regardless of the focus mode.

 After autofocus in ONE SHOT AF mode, focus manually by pressing the shutter button halfway and turning the focusing ring. (Full-time manual focus)

3. Zooming

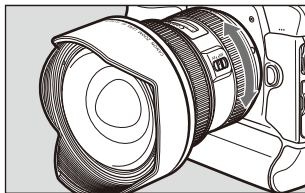

To zoom, rotate the zoom ring.

Also, the minimum focusing distance of the lens changes depending on focal length.

Focal Length (mm)	Min. Focusing Distance (m/ft)	Magnification (×)
11	0.32 / 1.05	0.06
16	0.29 / 0.95	0.10
24	0.28 / 0.92	0.16

-  Be sure to finish zooming before focusing. Zooming after focusing can affect the focus.
- Zooming in causes the front lens assembly to extend along the lens's optical axis. This adds to the weight of the lens assembly, so pointing it up or down when zooming in may increase or decrease the torque felt in the zoom ring.

4. Infinity Compensation Mark

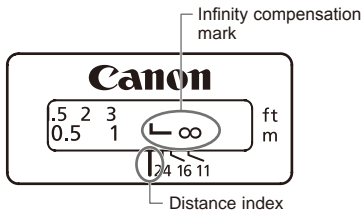

To compensate for shifting of the infinity focus point that results from changes in temperature, there is a margin at the infinity (∞) position. The infinity position at normal temperature is the point at which the vertical line of the distance scale L mark is aligned with the distance index.

I For accurate manual focusing of subjects at infinity, look through the viewfinder or look at the magnified image* on the LCD screen while rotating the focusing ring.

* For cameras with Live View shooting capability.

5. Infrared Index

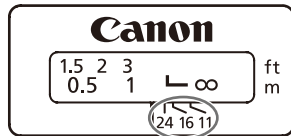

The infrared index corrects the focus setting when using monochrome infrared film. Focus on the subject manually, then adjust the distance setting by moving the focusing ring to the corresponding infrared index mark.

I Some EOS cameras cannot use infrared film. See the instructions for your EOS camera.

- I**
- The infrared index position is based on a wavelength of 800 nm.
 - The compensation amount differs depending on the focal length. Use the indicated focal length as a guide when setting the compensation amount.
 - Be sure to observe the manufacturer's instructions when using infrared film.
 - Use a red filter when you take the picture.

6. Lens Cap

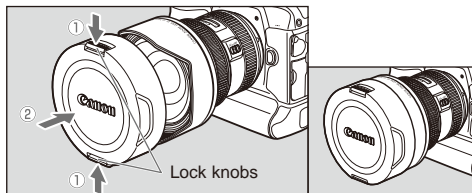

The lens cap can be attached by pinching the lock knobs and vertically aligning the lens cap with the lens hood as shown in the diagram.

 The recessed sections of the lens hood that the cap locks on to are located at the front inside edge of the top and bottom petals.

7. Filter (Sold separately)

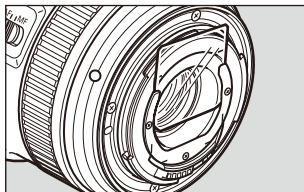

There is a gelatin filter holder at the rear of the lens. Cut the gelatin filter to fit within the white frames. Then insert the gelatin filter into the filter holder.

 The lens's rear lens group moves back toward the rear of the lens (camera side) the most when the lens is set to the wide end. Therefore, in order to prevent the rear lens element from making contact with a filter (when installed), we recommend using a filter only if the zoom ring is not set to the wide end.

8. Extension Tubes (Sold separately)

You can attach extension tube EF12 II for magnified shots. The shooting distance and magnification are shown below.

		Focusing Distance Range (mm)		Magnification (×)	
		Close distance	Long distance	Close distance	Long distance
EF12 II	11mm	Incompatible			
	24mm	188	203	0.73	0.53



MF mode is recommended for accurate focusing.

Specifications

Focal Length/Aperture	11-24mm f/4
Lens Construction	11 groups, 16 elements
Minimum Aperture	f/22
Angle of View	Diagonal: 126°05' - 84°, Vertical: 95° - 53°, Horizontal: 117°10' - 74°
Min. Focusing Distance	0.28 m/0.92 ft. (at 24 mm) 0.32 m/1.05 ft. (at 11 mm)
Max. Magnification	0.16x (at 24 mm)
Field of View	Approx. 196 x 307 mm/7.72 x 12.09 inch (at 0.32 m/1.05 ft.) - 74 x 112 mm/2.91 x 4.41 inch (at 0.28 m/0.92 ft.)
Filter	Gelatin filter holder (located at the rear of the lens)
Max. Diameter and Length	108.0 x 132.0 mm/4.25 x 5.20 inch
Weight	Approx. 1180 g/41.6 oz
Hood	Built-in
Lens Cap	Lens Cap 11-24
Case	LP1424

- The lens length is measured from the mount surface to the front end of the hood. Add 23.5 mm when including the lens cap and dust cap.
- The size and weight listed are for the lens only, except as indicated.
- The EF1.4X II, III/EF2X II, III extender and 250D/500D close-up lenses cannot be used with this lens.
- Aperture settings are specified on the camera.
- All data listed is measured according to Canon standards.
- Product specifications and appearance are subject to change without notice.

Canon