



Wireless
Communication

FreeSpeak II[®] (1.9GHz & 2.4GHz)

DX Series (2.4GHz)

WBS670/680 (518-686MHz UHF)

Wireless IFB (486.4-691.1MHz UHF)

About Intercom Technology

An intercom (intercommunication system) is a standalone, closed-circuit system for one-way “simplex” and/or two-way “duplex” communication. The general purpose of a professional intercom system is to facilitate simple to complex communication setups for a few to thousands of users who need to be continuously on talk and/or listen mode. Two-way communication systems can operate in half-duplex or full-duplex. With half-duplex systems, one party talks while the other party listens. With full-duplex systems, both parties can talk and listen at the same time as if they are in a natural conversation in person.

Users, who have different roles in a particular operation, can be in a conference or partyline together. Or they can be sub-divided into a matrix of independent groups in any one or many private intercom channels. In addition to establishing communication points, intercom can also interface with third-party devices such as 2-way radios, 4-wire audios, telephone, TV cameras, AES3 digital audio, relay control (for signal light activation or door control), etc. Coordinating activities via voice or through third-party devices such as relay controls require low-latency (delays measured in milliseconds).

The core technology of an intercom system could be based on one of the following platforms: 2-wire/analog, 4-wire/digital, wireless, and IP networks. The decision to deploy one platform over the other will greatly depend on requirements, environment and budget. These intercom platforms operate independently or can be integrated to form a larger system in order to address specific unique communication workflow needs. Moreover, intercom systems can be bridged together with different communication systems as part of a multi-platform solution.

In certain applications, intercom systems need to be geographically distributed to support the various communication positions in a given workflow. Therefore, they can be connected over 2-wire or 4-wire; MAD1 for close-distance connections such as floor-to-floor; optical fiber for short to long distances within a building; E1/T1 for inner-city connections; and IP networks (LAN, WAN, or Internet) for connections across a wide area, across town, and across the country.

Table of Contents

Wireless intercom systems offer the convenience of untethered communication for mobile users, while providing the power, flexibility and audio quality of wired systems.

Clear-Com provides the broadest range of wireless intercom systems for professional users who require a standalone wireless system or an integrated wireless solution to meet virtually any technical requirement, budget, and/or environments.

pg 4

BASIC SYSTEMS: Simple, Portable, Affordable

Wireless IFB (486.4-691.1MHz UHF)

DX100 (2.4GHz)

DX121 (2.4GHz)

DX200 (2.4GHz)

pg 6

ADVANCED SYSTEMS: Connectivity, Performance, Intuitive

DX210 (2.4GHz)

DX300ES (2.4GHz)

DX410 (2.4GHz)

WBS Series (518-608MHz, 614-686MHz UHF)

pg 10

HIGH PERFORMANCE SYSTEMS: Comprehensive, High Capacity, Extensible, Scalable

FreeSpeak II® (1.9GHz and 2.4GHz)

BASIC WIRELESS INTERCOM SYSTEMS

Clear-Com’s basic wireless intercom systems deliver full-duplex (simultaneous talk and listen) capabilities. These simple systems are typically deployed as standalone units that do not integrate or interface with any wired intercom systems. They offer high quality audio, interference-free communication at great value.

- > Wireless IFB
- > DX100
- > DX121
- > DX200

Wireless IFB

Wireless IFB (interruptible fold back) systems operate between 486.4 and 691.1MHz. Wireless IFBs are used for one-directional communication. Directors and other management can use this to monitor program audio, or for talent cueing and crew communications during a production.

The PRC-2 receiver provides simplicity and flexibility in a package that is intuitive for untrained users to operate.

Wireless IFB uses +/-20 kHz FM deviation for efficient use of the bandwidth, with compandor noise

reduction circuitry for an excellent signal to noise ratio.

**Operating Frequencies:
486.4 to 691.1 MHz**

- Block 19: 486.4 to 511.9 MHz
- Block 20: 512.0 to 537.5 MHz
- Block 21: 537.6 to 563.1 MHz
- Block 24*: 614.4 to 639.9 MHz
- Block 25*: 640.0 to 665.5 MHz
- Block 26*: 665.6 to 691.1 MHz

NOTE: This product is not approved for sale in Europe.

***These blocks are targeted to be banned by the FCC for use within the US by 2018.**



PTX-3



PRC-2

DX100 2.4GHz Digital Wireless Intercom

The portable, compact design makes the DX100 system ideal for mobile field applications. The DX100 system enables two-way communications in a compact, portable base station.

Up to 15 wireless belt packs can be assigned to each base station, four of which can be used in hands-free, full-duplex mode.

Digital Frequency-Hopping Spread Spectrum (FHSS) with encryption secures communication to prevent eavesdropping.

Remotely “unlatch” belt packs from transmitting at the base to stop a rogue belt pack that’s been left transmitting without having to locate the belt pack.

Triple diversity – space, time and frequency diversity provide redundant communication to make it the most dependable system available.

Flexible, battery-powered operation allows the base to be powered in four different ways:

- Six 1.5V “AA” batteries
- Optional rechargeable BAT850 battery
- 12 VDC automotive adapter
- 100-240 VAC power adapter (provided)

Power outage backup feature enables uninterrupted communication in the event of power loss.



MB100

DX121 2.4GHz Digital Wireless Intercom

The DX121 is a versatile, cost-effective system for adding wireless beltpacks to wired intercom systems. Up to 4 wireless beltpacks can be assigned to each base station, one of which can be used in hands-free, full-duplex mode.

2.4GHz Digital Frequency-Hopping Spread Spectrum (FHSS) 64-bit encryption ensures confidential communication.

Assignable relay closure provides advanced functionality when used with matrix intercoms or radio based communication systems.

Built-in one-port battery charger charges a remote beltpack or All-in-One headset battery.

Connects to headset jack of beltpacks and intercom panels.



DX200 2.4GHz Digital Wireless Intercom

The easy-to-use DX200 System comes complete with synthesized voice prompts, wireless isolated channel, simultaneous 2-wire and 4-wire operation, ISO+ mode, internal beltpack antennas, and more. Up to 15 beltpacks can be assigned to each base station. Any four beltpacks can be used in

hands-free, full-duplex mode, and a 5th can be added when the base station headset is used. The DX200 is expandable to a four base station system, supporting a total of 60 beltpacks with 16 in full-duplex, single-channel mode.



Compatible Beltpack (For use with the DX100, DX121 and DX200)

BP200 Features:

- Separate IC and ISO buttons
- Beltpack mic gain and side tone control
- Selectable PTT or latching button modes
- ISO restrict mode
- Internal antennas
- Lithium-Ion rechargeable batteries with up to 20 hours of operation
- User voice prompts
- Rugged construction



BP200 Beltpack

DX Series Technology

All DX Series wireless intercom systems feature Spectrum-Friendly™ technology for interference-free operation in the increasingly

crowded 2.4GHz frequency band. This technology prevents emerging frequency conflicts by designating the 2.4GHz operating frequency

range: low- (2.4019- 2.4399GHz), high- (2.4434-2.4814GHz), or full-band.

ADVANCED WIRELESS INTERCOM SYSTEMS

Clear-Com's advanced wireless intercom systems are full-duplex communication systems. These intuitive systems are easy to deploy and configure. Every advanced system was designed with facilities that could seamlessly interface with any wired intercom system, allowing mobile users to stay connected to fixed user positions in the covered area. Superb audio quality and system reliability make these systems the preferred wireless intercom of choice for many users.

- > DX210
- > DX300ES
- > DX410
- > WBS Series

DX210 2.4GHz Digital Wireless Intercom

The DX210 is a two-channel system that delivers a perfect blend in performance, connectivity with wired systems, and ease of use. The two separate 2-wire and 4-wire connections make it highly compatible with any industry-standard

2-wire intercom systems or 4-wire intercom/audio devices.

Each BS210 base station can support up to 4 full-duplex beltpacks and/or WH220 all-in-one wireless headsets for talk and listen capabilities or 11

half-duplex beltpacks for listen-only purposes. By linking four base stations together, up to 16 full-duplex or 44 half-duplex beltpack users can be in communication.

System Highlights:

- Wireless ISO Talk-around
- Digital Auto Nulling (Front Panel Access)
- Two separate 2-wire/4-wire connections
- Triple diversity – space, time and frequency – supporting extreme multi-path environments
- Spectrum Friendly technology
- Relay (GPIO) actuation with ISO function
- Feedback protection for un-terminated 2-wire channels



BS210



WH220 All-in-One Headset



BP210 Beltpack

DX300ES 2.4GHz Digital Wireless Intercom

The flexible DX300ES offers a two-channel mobile intercom system that is easy to set up and use, as well as expandable to accommodate larger operations. Its compact design makes it highly portable and convenient to deploy instantly where full-duplex communication is required.

Each base can support up to 4 full-duplex or 12 half-duplex wireless beltpack and/or WH301 wireless all-in-one headset users. By linking four base stations together, up to 16 full-duplex or 44 half-duplex beltpack users can be in communication.

Special features include dedicated channel relays and four-wire audio interfaces for ease of connectivity to third-party systems.

System Highlights:

- Fast, easy setup for strategic relocation
- Secure, 64-bit encryption
- Digital Frequency Hopping Spread Spectrum (FHSS)
- Convenient all-call button allows transmit on both channels
- Triple diversity – space, time and frequency diversity – supporting extreme multi-path environments
- Flexible power options: 100-240 VAC, 12-14 VDC, 1.5V “AA” batteries or an optional rechargeable BAT850 battery
- Portable size and weight
- Auxiliary Input and Output 10-pin terminal strip connector
- Dedicated channel relays



MB300ES



BP300 Beltpack



WH301 All-in-One Headset

DX410 2.4GHz Digital Wireless Intercom

The DX410 is a two-channel digital wireless system, delivering an overall better experience in performance, range and sound.

The system features 7kHz wideband audio, the same audio quality level as high-end wireless intercoms. Its expanded audio range and increased intelligibility enables even soft whispers to be heard clearly, even in high RF interference environments.

System Highlights:

- Two channels
- 7kHz wide bandwidth audio
- 2-wire and 4-wire bridging
- 2-wire auto-nulling
- Lost packet concealment
- Upgraded radio
- Supports up to 15 wireless beltpacks and/or wireless headsets



BS410 Base Station

DX410 also features 2-wire and 4-wire bridging and 2-wire auto-nulling. The bridging capability allows the option for combining the 2-wire and 4-wire ports together on either channel A or B, allowing operators to use a 4-wire out to send all the audio to a mixer, matrix intercom or other audio source. 2-wire auto-nulling enables fast and accurate integration with Clear-Com or TW wired partyline systems.

Each DX410 base station can support up to 15 registered BP410 wireless beltpacks and/or WH410 all-in-one wireless headsets. In a single-channel operation, any four beltpack users can engage in simultaneous, full-duplex (talk-listen) communication, while only three users may be in full-duplex mode in a dual-channel operation.

DX410 is simple to set up and configure, taking less time to deploy. No software programming is necessary.



BP410 Beltpack



WH410 All-in-One Headset

WBS Series UHF Analog Wireless Intercom

WBS comes in a single-channel (WBS-670) or dual-channel (WBS-680) option, with each base station supporting up to four full-duplex wireless beltpacks. The WBS-680 base station provides two separate channels for 2-wire or 4-wire connectivity.



WBS670 Single channel

The WBS-670 and WBS-680 operate in select frequency bands between 470- 686MHz. Both wireless systems are supplied with 24 factory-selected, intermodulation-free frequencies. Select from factory presets or any suitable frequency in 25kHz increments. 720 Tx and 720 Rx frequencies can be selected, each from independent 18 MHz operational bands.

System Features:

- Full talk/listen headset at the base
- Rear panel connections allow system expansion
- Input and output level adjustment controls for both the connected wired intercom and auxiliary audio connection
- WTA (Wireless-Talk-Around) button momentarily routes audio to only the wireless beltpacks monitoring the current channel, serving as isolation (ISO) channel
- Stage Announce (SA) button allows a (dry) relay signal
- RJ-45 connector for direct connection to a digital 4-wire intercom port, and a pair of auxiliary connectors
- A pair of efficient, half-wave co-linear antennas is supplied with system.



WBS680 Two-channel

HIGH PERFORMANCE WIRELESS INTERCOM SYSTEMS

When it comes to communication requirements for specialized applications, high performance wireless intercom systems are the right solutions. These systems provide exceptional RF performance and reliable connections, giving users the peace of mind even in the most demanding circumstances. They offer high capacity and scalability in order to meet the needs of complex configurations, greater number of talk groups or users, and expansive coverage areas. Moreover, they work even in challenging environments that exist indoors and outdoors.

> [FreeSpeak II®](#)

FreeSpeak II® 1.9GHz and 2.4GHz Digital Wireless Intercom Systems

FreeSpeak II is a powerful and reliable distributed wireless intercom platform for sophisticated and expansive communication needs. FreeSpeak II comes in a 1.9GHz version for operations in the 1.897-1.933GHz band and 2.4GHz for environments or geographies where either or both frequencies are available for use. The system can freely use a mix of both bands.

The FreeSpeak II system comprises of the base station, beltpacks, Transceiver Antennas, and splitter. FreeSpeak II can be implemented as a standalone base station system or as an integrated wireless solution within Eclipse HX matrices. The splitter can connect to base stations and/or Eclipse HX matrices via fiber to extend the Transceiver Antenna coverage out over long distances.

Flexible cellular roaming technologies allow users to move freely about in large, multi-site environments without the worry of fading or losing connection. The system provides point-to-point and group communication capabilities.



FreeSpeak II Base Station

Wireless Beltpack

The all-new five-channel, full-duplex FreeSpeak II digital beltpack was uniquely designed for the rigorous demands of large-scale operations and continuous communication use. Ergonomic form factor, intuitive operation, and a rugged housing make the beltpack ideal for extended use.

Full-duplex 7kHz bandwidth offers high audio quality and reduces the strain on the user's ears after extended usage.

Four push-to-talk one reply key and two rotary encoders allow up to five

communication routes to be assigned to each beltpack. These can be any desired combination of group and point-to-point communication assignments.

Large OLED display provides extensive information, including the names of beltpacks, assigned users and groups of each beltpack, battery level, and signal strength.

A variety of beltpack menus are accessible via the OLED display including headset levels, microphone levels, audible alert at low battery level, and adjustable local sidetone.



FreeSpeak II 1.9GHz



FreeSpeak II 2.4GHz

Beltpack Feature Highlights

- Up to five communication routes per beltpack, with selective access to more than 24 channels
- Four programmable pushbuttons, two rotary encoders and a reply button
- Menu driven display, which can be partially or completely restricted
- Secure system – beltpacks are registered to a particular base station or Matrix or can have secure access to multiple control functions
- Internal antennas – no antenna breakage or damage
- Long battery usage – typically 18 hours of continuous talk time
- Two battery options – rechargeable Li-Ion cells or disposable Alkaline AA Batteries
- Drop-in charging port with built-in USB battery and beltpack charging capability
- Strong metallic beltclip and shoulder strap points
- Over-the-air beltpack registration and regionalization
- Real-time monitoring of battery per beltpack
- “Listen Again” audio memory to replay last 15 seconds of audio
- Technician’s flash light



Drop-in battery and beltpack charger



USB Port for local DC powering



18+ hours of battery operation (door shown open)



Ergonomic design for beltpack controls

Transceiver Antennas

FreeSpeak II users can roam thousands of feet from the base station while staying connected. This is achieved through the Cellular Roaming capability between distributed Transceiver Antennas. The antenna splitter extends the base station to create an expansive coverage area with multiple antennas, which provide connections to the wireless beltacks.

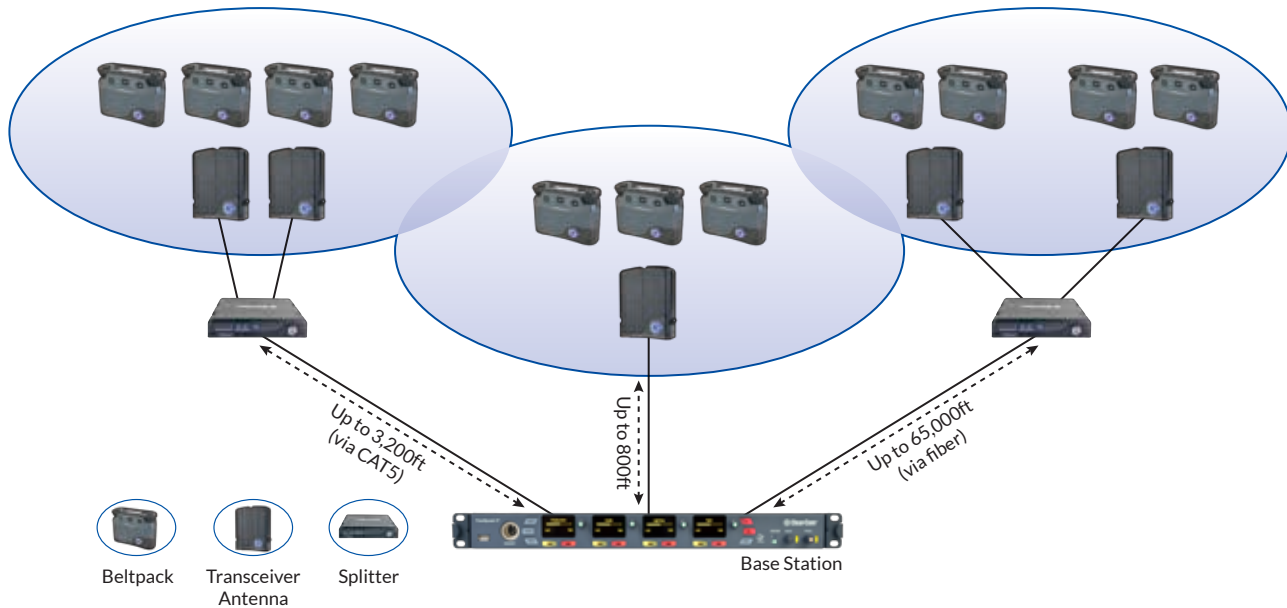

Expansive wireless coverage can be achieved by strategically placing up to 10 remote antennas across a wide coverage area. Each Transceiver Antenna can be positioned away from the base station or matrix up to 3,280 feet using a CAT5 connection or as far as 65,000 feet using a fiber connection. Each powered Antenna can create a coverage zone of up to 300 ft (indoor) or up to 800 feet (outdoor).

Unique to FreeSpeak II is the ability for 1.9GHz and 2.4GHz beltpacks and active Transceiver Antennas to co-operate in the same system (either the base station or integrated matrix solution), thus increasing both the quantity of wireless users and cell roaming area.

When using the base station, up to 25 full-duplex wireless beltpacks using either or both 1.9GHz and 2.4GHz bands can be connected.

In an integrated Eclipse HX matrix setup, as many as 50 1.9GHz and 40 2.4GHz (or 25 1.9GHz in North America plus 40 2.4GHz) full-duplex wireless beltpacks can be used at the same time by positioning up to 20 or more distributed remote antennas at strategic locations. These beltpack users are then able to directly communicate with any other remote or local matrix panel or other wireless or wired beltpack user who is on the Eclipse HX Matrix System network.

Key Features:

- IP rated for water and dust resistance
- LED power indicator light
- Microphone stand mounting
- Ethercon rugged connection
- SFP slot on splitter for single- or multi-mode fiber connectivity



2.4GHz Transceiver



1.9GHz Transceiver



Antenna Splitter

Integrated Wireless

FreeSpeak II is the only wireless system on the market that can seamlessly integrate its wireless beltpacks with Clear-Com’s Eclipse HX Digital Matrix Intercom Systems.

With FreeSpeak II, wireless beltpack users can communicate with any Eclipse HX panel users on a one-to-one or group basis. This unique capability is achieved with the E-Que-HX cellular controller card which fits directly in the matrix frames.

Each E-Que-HX card connects up to 10 Antennas (with splitter) to provide beltpack connections to any number of ports within the Matrix System.

Up to 50 wireless beltpacks per Matrix (depending on environment) can roam between 40 Transceiver Antennas and communicate on a Matrix System. Up to four E-Que-HX cards can be used in one Matrix frame.

Integrated FreeSpeak II has the ability to individually address each beltpack and then connect that beltpack to one or many users on the Matrix. Up to 800ft (245m) can be achieved under good radio frequency conditions –

adding more Transceiver Antennas can extend the range.

Patented Dynamic Port Allocation technology allows the beltpacks to roam between Transceiver Antennas without breaking connections.

Standard CAT5 cabling connects the Matrix via a network of Transceiver Antennas and antenna splitter. Simply add additional Transceiver Antenna splitters to expand the number of users.

FreeSpeak II 1.9 GHz Beltpacks	
Part #	Countries Approved For Use
FSII-BP19-X4-US FSII-BP19-X5-US FSII-BP19-X7-US	United States, Canada
FSII-BP19-X4-EU FSII-BP19-X5-EU FSII-BP19-X7-EU	Europe Union Countries (CE), Australia, New Zealand, Hong Kong, Singapore
FSII-BP19-X4-J FSII-BP19-X5-J FSII-BP19-X7-J	Japan
FSII-BP19-X4-LA FSII-BP19-X5-LA FSII-BP19-X7-LA	Argentina
FSII-BP19-X4-B FSII-BP19-X5-B FSII-BP19-X7-B	Brazil

FreeSpeak II 2.4 GHz Beltpacks	
Part #	Countries Approved For Use
FSII-BP24-X4 FSII-BP24-X5 FSII-BP24-X7	United States, Argentina, Canada, Brazil, Mexico, China, Japan, New Zealand, S. Korea, Australia, Singapore
FSII-BP24-X4-EU FSII-BP24-X5-EU FSII-BP24-X7-EU	Europe Union Countries (CE)

FreeSpeak II 1.9 GHz Transceivers	
Part #	Countries Approved For Use
FSII-TCVR-19	United States, Canada
FSII-TCVR-19-EU	Europe Union Countries (CE), Australia, New Zealand, Hong Kong, Singapore
FSII-TCVR-19-J	Japan
FSII-TCVR-19-LA	Argentina
FSII-TCVR-19-B	Brazil

FreeSpeak II 2.4 GHz Transceivers	
Part #	Countries Approved For Use
FSII-TCVR-24-US	United States, Argentina, Canada, Brazil, Mexico, China, Japan, New Zealand, S. Korea, Australia, Singapore
FSII-TCVR-24-EU	Europe Union Countries (CE)

Wireless Accessories

DX Series (DX100, 121, 200, 210, 300ES, 410)

Batteries and Chargers



BAT41



BAT50



BAT850



AC40A Battery Charger



AC50 Battery Charger



AC850A Battery Charger

Power Supplies



For AC40A and all DX base stations



For AC50 US/Canada



For AC50 Worldwide

Miscellaneous Accessories



DX Base Antenna



DX Antenna Splitter/Combiner



1RU Antenna Mounting Kit



SP10 Monitor Speaker



DX Beltpack Pouch



CAT-5 Cable

Wireless Accessories

FreeSpeak II



AC60 Battery Charger



BAT60



Battery Charger Wall-mount Bracket



FSII-SPL Antenna Splitter

WBS Series



WTR4C Battery Charger

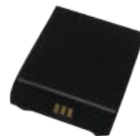











WTR-BAT

DX Wireless Battery and Charger Compatibility Chart

	Beltpack				All-in-One Wireless Headset			Base Stations	
	BP200	BP210	BP300	BP410	WH220	WH301	WH410	MB100	MB300ES
Battery	BAT41	BAT41	BAT41	BAT50	BAT50	BAT50	BAT50	BAT850	BAT850
Charger	AC40A	AC40A	AC40A	AC50	AC50	AC50	AC50	AC850	AC850

DX Base Station Compatibility

MB100	•	•			•				
MB121	•	•			•				
BS200	•	•			•				
BS210	•	•			•				
BS410				•			•		
MB300			•			•			
MB300ES			•			•			
EB300			•			•			

Compatible Headsets	Description	DX Series (MD4 connector)	FreeSpeak II (XLR connector)	WBS (XLR connector)	Wireless IFB (mini-jack connector)
CC-110-X4 	Single- or double-ear premium light-weight headsets. Superior comfort Dynamic mic rotates 300-degrees. Mic boom acts as an On/Off switch for quick muting. 4-pin female XLR connector		●	●	
CC-220-X4 			●	●	
CC-300-X4 	Single- or double-ear headsets. Excellent noise attenuation. Superior comfort Dynamic mic rotates 300-degrees. Mic boom acts as an On/Off switch for quick muting. 4-pin female XLR connector		●	●	
CC-400-X4 			●	●	
CC-40 	Single- or double-ear headsets. 200/400 Ohms and excellent noise attenuation with a dynamic mic. 4-pin female XLR connector		●	●	
CC-60 			●	●	
CC-15-MD4 CC-15-X4 	Ultra comfortable, single- or dual-ear, light-weight headsets Electret noise-canceling microphone mounted on a flexible boom which rotates for left or right side use. 4-pin female XLR or mini-din connector options	●	●	●	
CC-30-MD4 CC-30-X4 		●	●	●	
CC-26K 	Single-ear, 300-Ohm Ultra light-weight (1.3oz) headset with dynamic, noise-canceling mic element on a flexible boom. 4-pin female XLR connector		●	●	
CC-010A 	IFB ear set includes audio driver, coiled acoustic eartube with clothing clip, and 5ft (1.5m) cable with 1/8" (3.5mm) straight mini-jack connector				●

Compatible Headsets Accessories	Description	DX Series	FreeSpeak II	WBS	Wireless IFB
MD-XLR Headset Adapter	These adapters enable headsets with dynamic mics and XLR connectors to interface with all the DX Series headset jacks. An active built-in circuit provides impedance matching and DC isolation. XLR adapters interface with 4P male, 4P female or 5P male headset connectors	●			
Headset Extension Cable	Six-foot headset extension cable for all mini-DIN DX Series headset connectors	●			
HSI6000 Headset Interface Adapter	The HSI6000 allows a standard 2.5mm cell phone headset to be connected to the DX Series beltpacks	●			

	Radio Frequency	# of Channels on the Beltpack	Number of Beltpack per Base	Number of Stacked Bases	Max Distance: Antenna to Base	Max Distance: Beltpack to Antenna
BASIC						
DX100	2.4GHz	1	4 Full-Duplex & 11 Half-Duplex Listen	1	Up to 65ft (20m) using Coax	1000ft (300m)
DX121	2.4GHz	1	1 Full-Duplex & 3 Half-Duplex Listen	4	Up to 65ft (20m) using Coax	1000ft (300m)
DX200	2.4GHz	1	4 Full-Duplex & 11 or 12 Half-Duplex Listen	4	Up to 65ft (20m) using Coax	1000ft (300m)
ADVANCED						
DX210	2.4GHz	1 or 2	3 or 4 Full-Duplex & 11 or 12 Half-Duplex Listen	4	Up to 65ft (20m) using Coax	1000ft (300m)
DX300ES	2.4GHz	1 or 2	3 or 4 Full-Duplex & 11 or 12 Half-Duplex Listen	4	Up to 65ft (20m) using Coax	1000ft (300m)
DX410	2.4GHz	2	3 or 4 Full-Duplex & 11 or 12 Half-Duplex Listen	4	Up to 65ft (20m) using Coax	1000ft (300m)
WBS670 WBS680	518-608MHz, 614-686MHz	1/2 (one at a time)	4 Full-Duplex; Unlimited Half-Duplex Listen	4	Coax cable length to be provided by others	1640ft (500m)
HIGH PERFORMANCE						
FreeSpeak II 1.9	1.8-1.93GHz	4 plus reply	25 (Base) 50 (Matrix EU) 25 (Matrix USA)	Subject to max beltpacks in radio space	3,280ft (1km) (with CAT5) 65,000ft (20,000m) (with fiber)	300ft (90m) (indoor) 800ft (245m) (outdoor)
FreeSpeak II 2.4	2.4GHz	4 plus reply	25 (Base) 40 (Matrix)	Subject to max beltpacks in radio space	3,280ft (1km) (with CAT5) 65,000ft (20,000m) (with fiber)	300ft (90m) (indoor) 800ft (245m) (outdoor)

Other Clear-Com® Intercom Products

Partyline Wired Intercom

Clear-Com Encore

Analog 2-wire, group communication systems with intuitive plug-and-play design and superior audio clarity best known as the “Clear-Com Sound”.



Digital Network Intercom

HelixNet

Flexible, scalable, and intelligent digital network partyline system platform for dynamic group communication.

Integrated Matrix and IP Communication Solutions

Eclipse HX

Eclipse HX Digital Matrix Platform is the latest advancement in digital intercom technology for enabling critical inter-communications among teams who need direct (point-to-point) and one-to-many (group and partyline or conference) connections. Eclipse HX can scale up to a large communication solution by networking multiple systems together. The system can connect over 4-wire, MAD1, optical fiber, E1/T1 and IP networks. Eclipse HX system frames and the panels have native IP capabilities built in for integrating with IP-based communication solutions.



Connectivity Solutions

Clear-Com offers connectivity solutions designed for linking multiple intercom systems together over IP networks, routing and distributing audio and video signals over optical fiber networks, and interfacing communication solutions with SIP telephony protocols and 2-way radios.

Intercom Connectivity

ICON is a collection of communications products that link local or geographically distributed intercom terminals and end-points together. ICON Solutions operate over Ethernet/IP networks and/or optical fiber links.

ICON: LQ Series

LQ Series devices provide intercom connectivity for linking multiple intercom systems together and/or extending the capabilities and intercom channels of a single system to one or more remote locations over IP networks. LQ eliminates the need for time-consuming and costly audio cable runs.

With either the 2, 4, or 8 channel option, LQ can interface with and route audio and call signals between any industry-standard partyline intercom and 4-wire devices over LAN, WAN or Internet. LQ devices can also connect to Eclipse HX matrix frames via an IVC-32-HX card to remote intercom or audio sources over IP networks.



ICON: ProGrid™ Signal Transport Solutions

Based on the open AES3 and AES10 (MADI) standards, ProGrid is designed for ultra-fast transport, distribution, and routing of audio, intercom, video signals and control data over the OPTOCORE® (Optical Fiber) and SANE (Synchronous Audio Network + Ethernet) platforms.

ProGrid offers redundancy, robustness and reliability for small to very large infrastructural requirements. ProGrid is capable of matrixing up to 1024 channels across short or long distances.

Any incoming signal is capable of being routed to any output or multiple outputs as a continuous stream of data, without buffering, packaging or compression.



Interoperability Solutions

Clear-Com Gateway

Interoperability is the ability to communicate across multiple different systems in order to facilitate coordination of actions at an event at every level. Clear-Com's Interoperability Solutions address the communication challenges

with gateway solutions that link and bridge a myriad of communication systems such as radios, intercoms, telephones and IP networks.

Clear-Com® Gateway is an interoperability platform for linking and bridging disparate communication systems to deliver advanced radio bridging, radio interfacing and IP connectivity on a single platform.



Corporate Description

Clear-Com, an HME company, is a trusted global provider of professional real-time communications solutions and services since 1968. We innovate market proven technologies that link people together through wired and wireless systems.

Clear-Com was first to market portable wired and wireless intercom systems for live performances. Since then, our history of technological advancements and innovations has delivered significant improvements to the way people collaborate in professional settings where real-time communication matters.

For the markets we serve – broadcast, live performance, live events, sports, military, aerospace and government – our communication products have consistently met the demands for high quality audio, reliability, scalability and low latency, while addressing communication requirements of varying size and complexity.

Our reputation in the industry is not only based on our product achievements, but also on our consistent level of customer engagement and dedication to delivering the right solutions for specialized applications, with the expertise to make it work. Around the globe and across markets, Clear-Com's innovations and solutions have received numerous awards and recognitions for ingenuity and impact to customers.

Americas and Asia-Pacific Headquarters

California, United States

Tel: +1.510.337.6600

Email: SalesSupportUS@clearcom.com

Email: SalesSupportAPAC@clearcom.com

Europe, Middle East, and Africa Headquarters

Cambridge, United Kingdom

Tel: +44 1223 815000

Email: SalesSupportEMEA@clearcom.com

China Representative Office

Beijing, P.R.China

Sales/Marketing Tel: +86 10 59002608

Service Tel: +86 10 59000198

Email: SalesSupportAPAC@clearcom.com

www.clearcom.com