

SPECIFICATIONS

| | |
|---------------------------------------|---|
| Loudspeaker Type: | 2-way, coaxial, weather-resistant, full-range |
| Operating Range: | 80 Hz to 18 kHz 90 Hz to 12.5 kHz (± 3.5 dB) |
| Max Input Ratings: | 200W continuous, 500W program 40 volts RMS, 89 volts momentary peak |
| Recommended Power Amplifier: | 420W to 600W @ 8 ohms |
| Sensitivity (1W/1m): | 98 dB SPL (100 Hz to 13 kHz 1/3 octave bands) 97 dB SPL (250 Hz to 4 kHz speech range) |
| Maximum Output: | 121 dB SPL / 128 dB SPL (peak) |
| Nominal Impedance: | 8 ohms |
| Minimum Impedance: | 4.2 ohms @ 9.9 kHz |
| Nominal -6dB Beamwidth: | 60°H (+20° / -6°, 1.6 kHz to 12.5 kHz) 60°V (+20° / -3°, 1.6 kHz to 12.5 kHz) |
| Axial Q / DI: | 15.2 / 11.8, 1.6 kHz to 12.5 kHz |
| Crossover Frequency: | 2 kHz |
| Recommended Signal Processing: | 60 Hz high pass filter |
| Drivers: | LF 1 x 12" HF 1 x 1" exit titanium free, Ferrofluid-cooled |
| Driver Protection: | DYNA-TECH protection circuitry |
| Input Connection: | 12 foot (4 m) SJOW #16 gauge |
| Controls: | None |
| Enclosure: | Rotomolded LLDPE, light grey |
| Mounting/Rigging Provisions: | (5) 3/8-16 rigging points |
| Grille: | 3-layer WeatherStop™, light grey (Zinc-rich epoxy dual-layer powder coated perforated steel grille, foam, woven poly mesh) |
| Environmental Performance: | IEC529 IP54W rating with a minimum 5-degree downward aiming angle |
| Required Accessories: | 24 dB/Oct high pass filter |
| Supplied Accessories: | (1) Yoke bracket, light grey (1) Aiming strap |
| Optional Accessories: | PMB Series pole mount brackets |
| Dimensions—Height: | 16 inches (406.4 mm) |
| Width: | 16 inches (406.4 mm) |
| Depth: | 15.94 inches (404.88 mm) |
| Weight: | 35 lbs (15.9 kg) |
| Shipping Weight: | 42 lbs (19.1 kg) |

NOTES:

1. Sensitivity: Free field pink noise measurement at 20 ft (6.1 m) at 50% power; extrapolated to 1 meter and an input of 2.83 volts RMS.
2. Watts: All wattage figures are calculated using the rated nominal impedance.



APPLICATIONS

- Convention centers
- Fill speaker for stadia, athletic fields, arenas and race tracks
- Outdoor background music / paging systems
- Theme and amusement parks
- Fairgrounds, rodeos, air shows
- Malls, cruise ships, skating rinks
- Swimming pools
- Portable sound systems

FEATURES

- Weather-resistant, rotomolded UV enclosure
- Weather-treated drivers and crossovers
- Corrosion-resistant zinc-rich epoxy dual-layer powder coated steel grille and yoke
- High fidelity
- High efficiency
- Integral mounting points
- High power passive crossover
- Optional 200W, 70V autoformer
- Five-year product warranty / Fifteen-year enclosure warranty

DESCRIPTION

The R.5COAX66 high fidelity, two-way, full-range loudspeaker system is engineered to provide quality full-range sound in a variety of outdoor and indoor applications. Its wide range, smooth frequency response and high efficiency ensure both high fidelity music reproduction and superb projection of clear intelligible speech with very low distortion. Five-year limited product warranty; fifteen-year enclosure warranty.

FREQUENCY RESPONSE

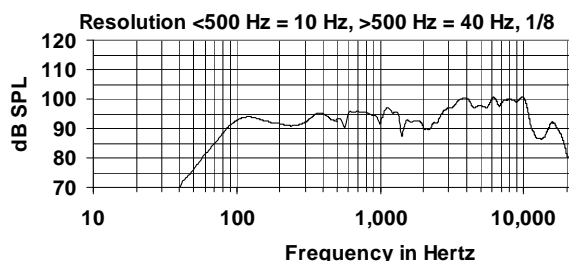

IMPEDANCE

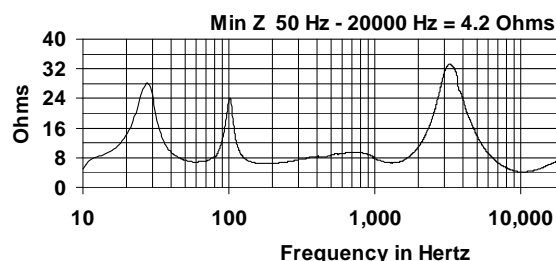

BEAMWIDTH

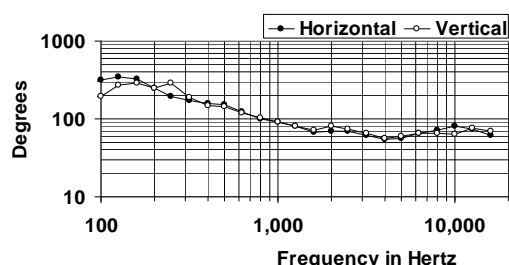

AXIAL Q

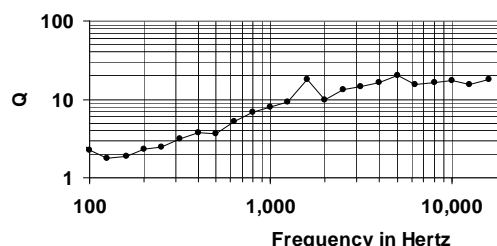

DIMENSIONS

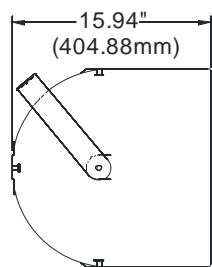

SIDE VIEW

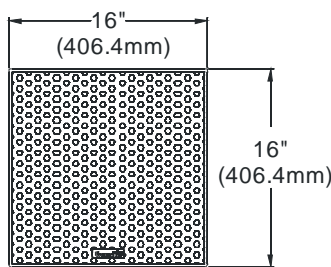

FRONT VIEW

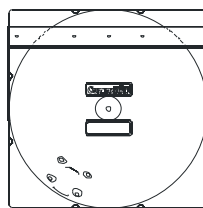

REAR VIEW

R.5 YOKE

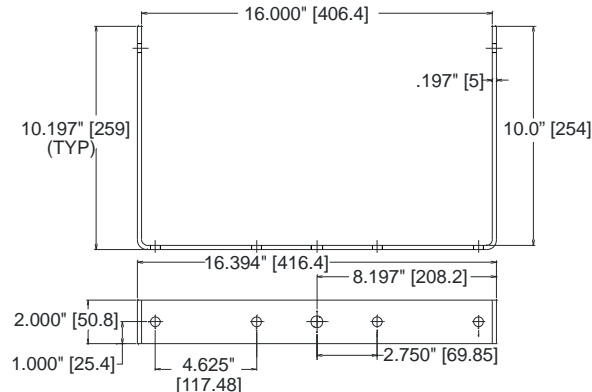

ARCHITECTURAL SPECIFICATIONS

The loudspeaker system shall be a two-way, full-range bass reflex design with a single cast 12" and one 1" exit HF driver coaxially mounted on a 60° x 60° horn. Drivers shall be connected to an integral crossover with a crossover frequency of 2 kHz and integral over-current protection circuitry. The cabinet shall be a roto-molded linear low density polyethylene enclosure providing weather and UV resistance with a three-layer weather resistant grille. The steel grille shall be powder coated with a proprietary zinc-rich epoxy dual-layer powder coating process in light grey to color match the enclosure. The system shall have an IEC529 IP rating of IP54W with a minimum 5-degree downward aiming angle. The input connection shall be one 12' (4m) SJOW #16-gauge cable with stripped ends. The enclosure shall incorporate five 3/8-16 rigging points for multiple mounting options. In addition, the loudspeaker will be supplied with one zinc-rich epoxy dual-layer powder coated steel yoke bracket. The system shall have an amplitude response of 90 Hz to 12.5 kHz (+/-3.5dB), input capability of 40 V RMS, 98 dB Sensitivity at one meter and 2.83 V, 8 Ohm nominal impedance. The nominal dispersion shall be 60° H x 60° V from 1.6 kHz to 12.5 kHz. The dimensions of the enclosure are defined as 16" x 16" x 16" (HWD) at a weight of 35 lbs. (38.5 lbs for the optional 70V version).

Community strives to improve its products on a continual basis. Specifications are therefore subject to change without notice.