



BrightEye™

BrightEye and BrightEye NXT Rack Mount Assembly Kit Installation Guide

Models BERKMT-FULL and BERKMT-RR
Revision 1.3



ENSEMBLE

D E S I G N S

Contents

Overview	3
List of what is included in your BrightEye Rack Mount Kit (BERKMT-FULL or BERKMT-RR)	4
Illustrations and associated letters for components in the BrightEye Rack Mount Kit	4
Installing a BrightEye NXT in the Rack Mount, Overview	7
Installing a BrightEye NXT in the Rack Mount, Details	8
Installing a BrightEye in the Rack Mount	10
Using Blank Filler Panels in the Rack Mount	12
Additional Parts Order Info	13
<i>BrightEye Rack Mount Retainer Kit – BERK-RET</i>	13
<i>BrightEye Rack Mount Filler Panel Kit – BERK-BPKit</i>	13
<i>BrightEye Single-High Blank Panel – BEBP</i>	13
Troubleshooting	14
<i>There's a gap between the blank filler panel and the side of rack mount</i>	14
<i>My BrightEye NXT won't complete its power up cycle</i>	14
Factory Service	14

Overview

The BrightEye Rack Mount Kit is designed to accommodate any mixture of BrightEyes and BrightEye NXTs. The rack tray occupies 1RU and can hold 3 BrightEye NXTs, or any combination of BrightEye NXTs, single-high BrightEyes and double-high BrightEyes. Retainers fasten to the rack tray's right angle mounting block to hold the units securely in place. All installation can be done from the front, so it's easy to mount the BrightEye Rack Mount into your rack and then populate it. Blank filler panels may be installed in unused spaces, if desired. See the illustrations below for a few examples of how the rack can be populated.

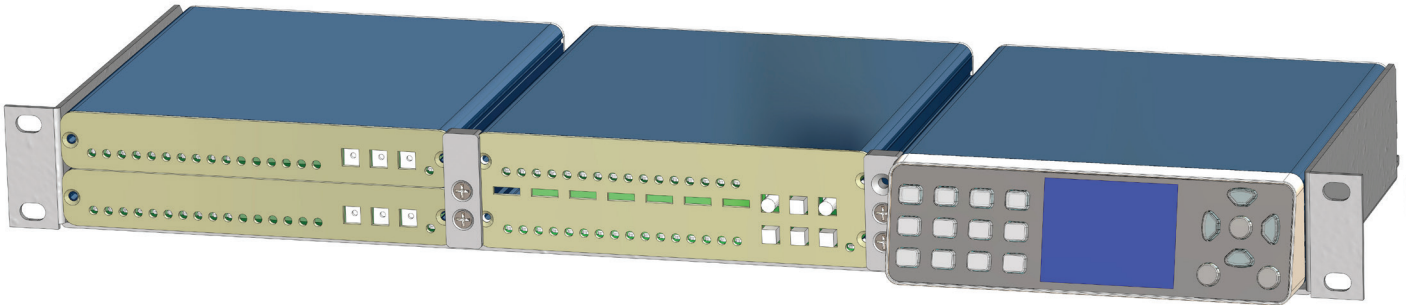

BrightEye Rack Tray populated with 2 single-high BrightEyes (left), 1 double-high BrightEye (center), and 1 BrightEye NXT (right).

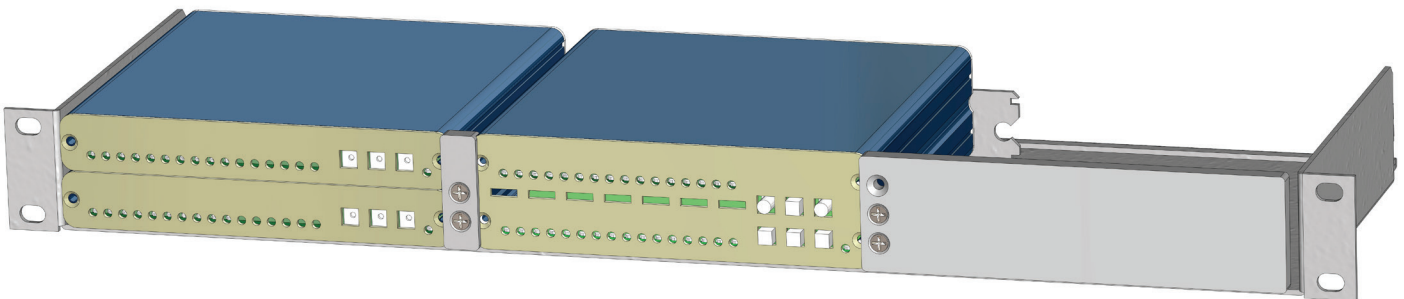

BrightEye Rack Tray populated with 2 single-high BrightEyes (left), 1 double-high BrightEye (center), and 1 BrightEye Blank Filler Panel (right).

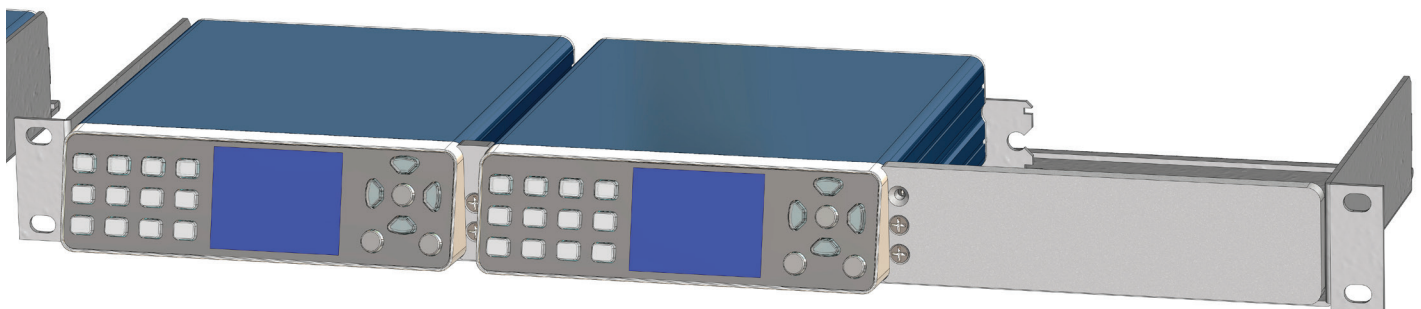

BrightEye Rack Tray populated with 2 BrightEye NXTs (left and center) and 1 NXT Blank Filler Panel (right).

List of what is included in your BrightEye Rack Mount Kit (BERKMT-FULL or BERKMT-RR)

Quantity	Description	Reference Letter	Ensemble Designs Part Number
1	BrightEye Rack Tray, Black	A	52002231
2	BrightEye to NXT Rack Mount Retainer	B	52002232
2	BrightEye to BrightEye Rack Mount Retainer	C	52002233
2	NXT to NXT Rack Mount Retainer	D	52002234
4	NXT Retainer Washer	E	52002236
4	6-32 x 1/2" Phillips Flat Black Z/P Machine Screw w/Nylock		30001147
4	4-40 x 7/16" Phillips Flat Machine Screw, Black Oxide		30001148
2	NXT Blank Filler Panel for the BrightEye Rack Tray (BERKMT-FULL only)	F	52002238
2	BrightEye Blank Filler Panel for the BrightEye Rack Tray (BERKMT-FULL only)	G	52002239

Note: Two BrightEye rack mount kits are available to meet your needs. The BERKMT-FULL kit includes blank filler panels and the BERKMT-RR does not.

Illustrations and associated letters for components in the BrightEye Rack Mount Kit

The following pages show detailed illustrations of the components in the BrightEye Rack Mount Kit, and reference the letter associated with each part. This document generally uses the letter as the reference for simplicity.

BrightEye Rack Tray, empty. Accepts any combination of BrightEye NXTs, single-high BrightEyes and double-high BrightEyes.

Referred to in this document as part **A**

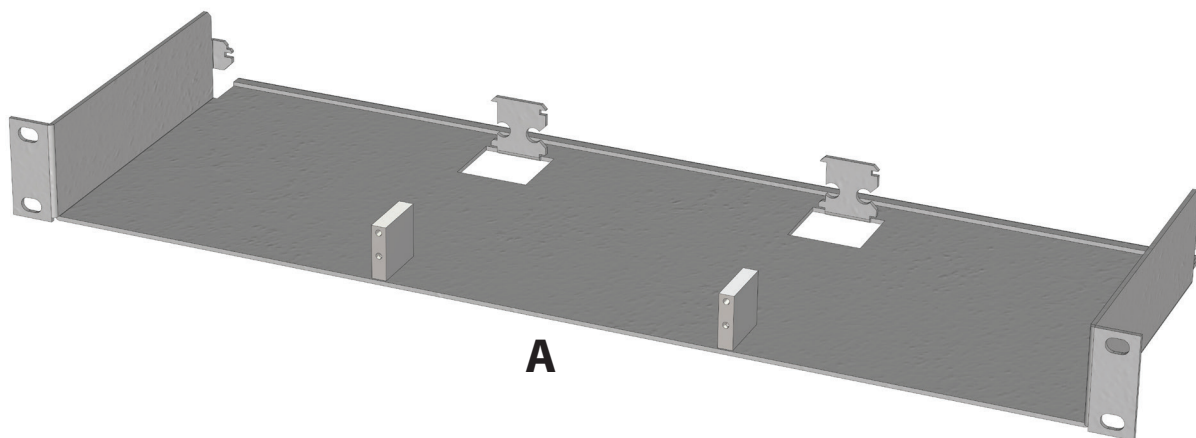

BrightEye to NXT Retainer, front and rear views

Referred to in this document as part **B**

Note: This asymmetrical part intentionally has three holes so that it can be flipped 180 degrees to accommodate retaining a BrightEye/NXT combination in any position. Only the bottom two holes will be used to attach to the rack's right angle mounting block.



B front

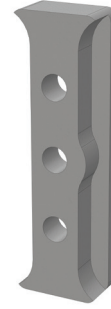

B rear

BrightEye to BrightEye Retainer, front and rear views

Referred to in this document as part **C**



C front



C rear

NXT to NXT Retainer, front and rear views

Referred to in this document as part **D**



D front



D rear

NXT Retainer Washer

Referred to in this document as part **E**

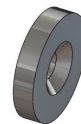

E

NXT Blank Filler Panel, front and rear views
(Two included in BERKMT-FULL kit)

Referred to in this document as part **F**

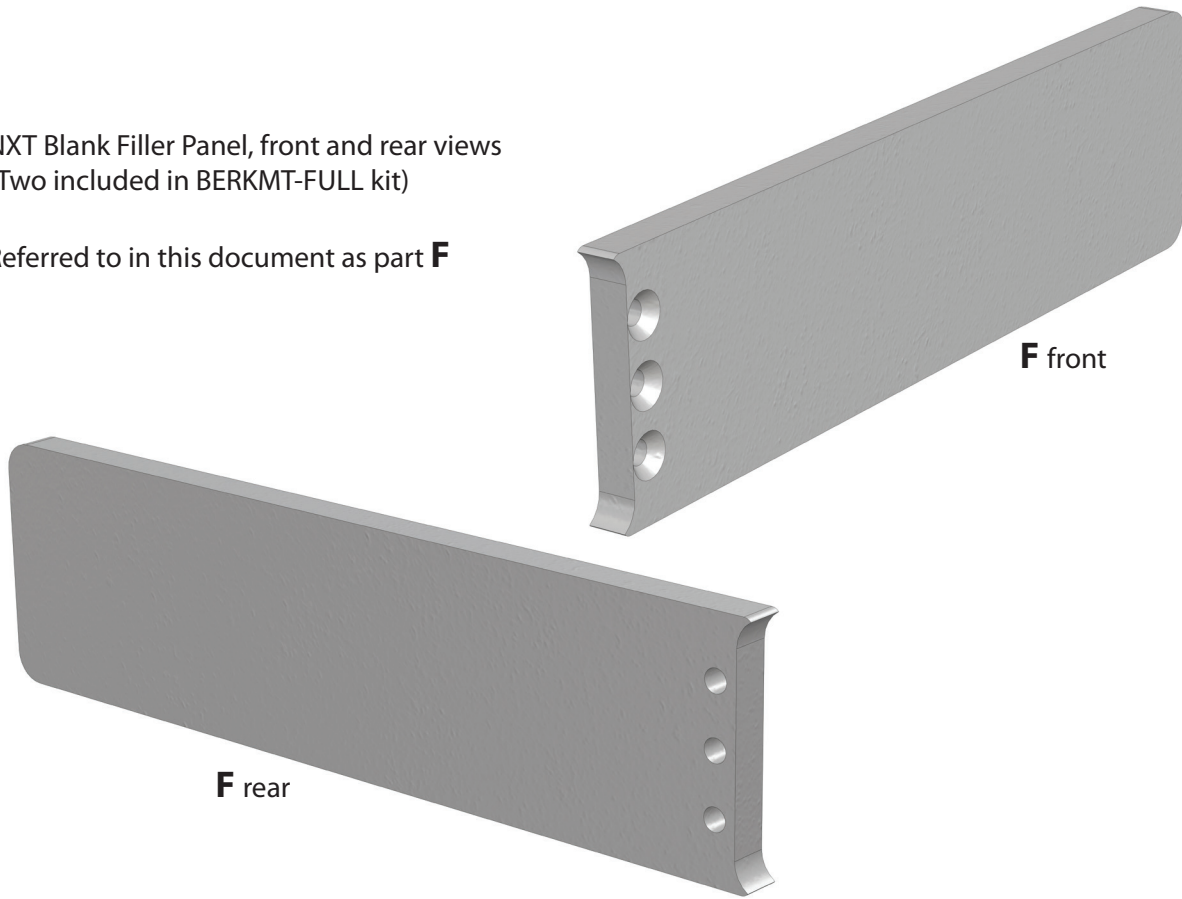

BrightEye Blank Filler Panel, front and rear views
(Two included in BERKMT-FULL kit)

Referred to in this document as part **G**

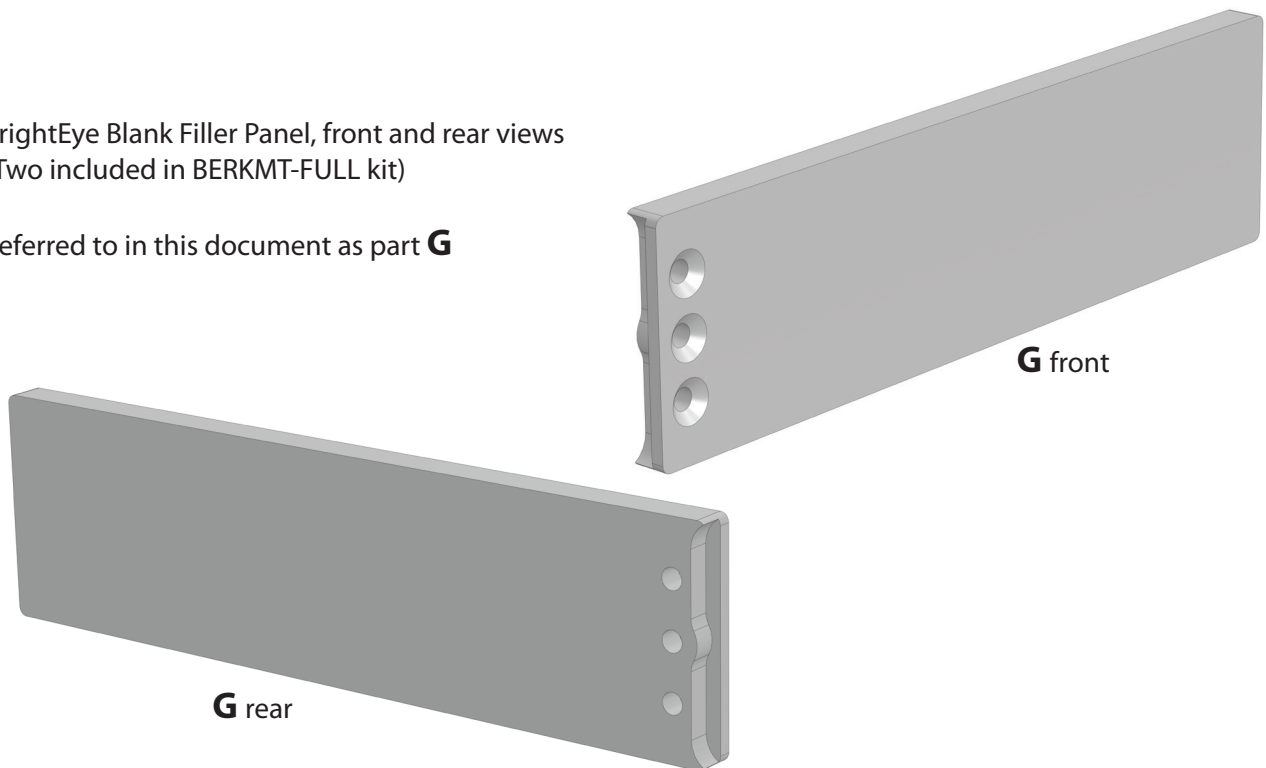

Installing a BrightEye NXT in the Rack Mount, Overview

To install a BrightEye NXT into the rack mount:

- Remove the rubber feet from the bottom of the BrightEye NXT
- Choose the position in the rack for installation
- Install the appropriate NXT Retainer Washer(s)
- Install the appropriate front retainer

See the below illustration for an overview, and the detailed instructions on the following pages.

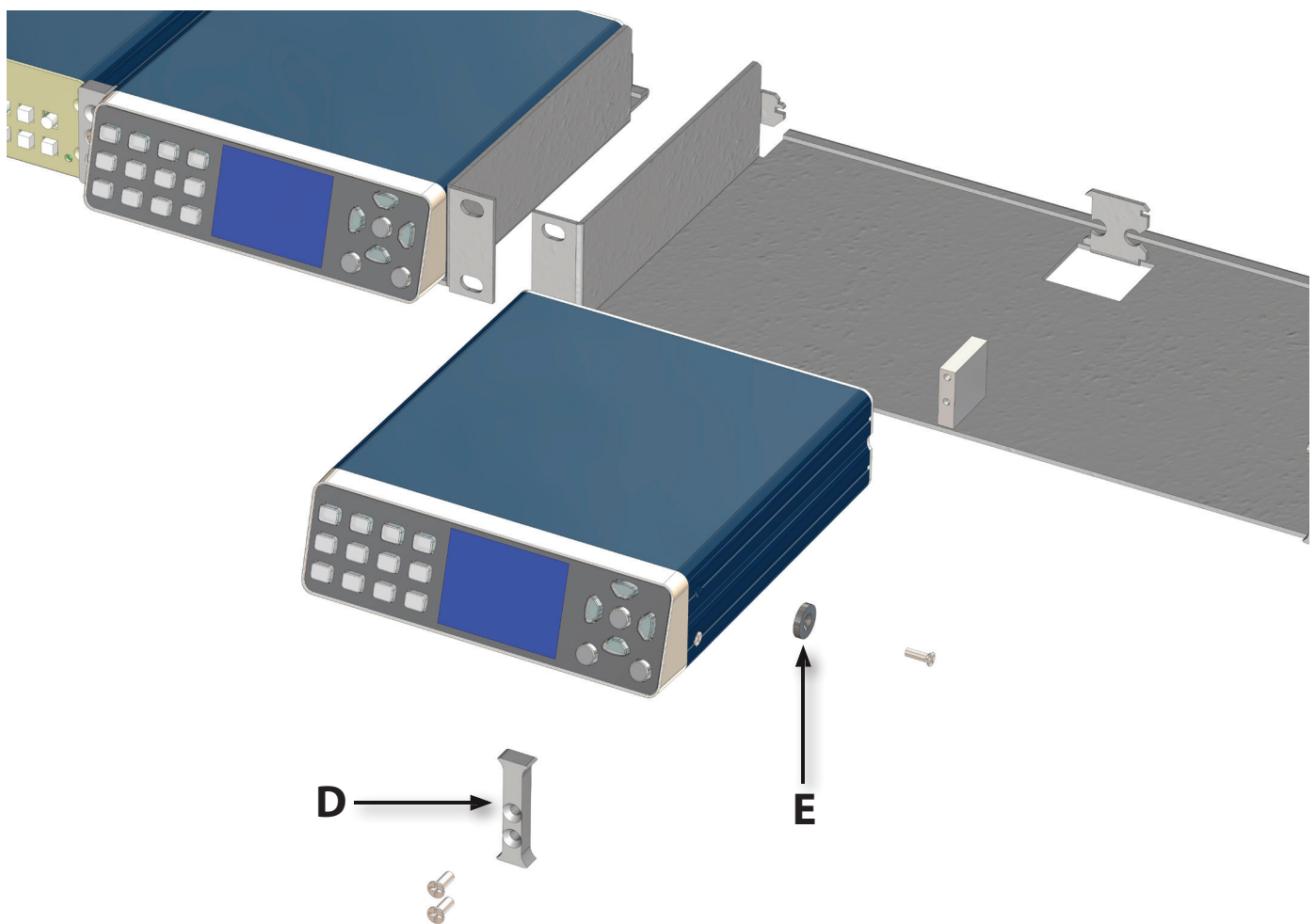

Illustration for installing a BrightEye NXT, using a NXT to NXT front retainer (**D**), and a NXT Retainer Washer (**E**), exploded view

Installing a BrightEye NXT in the Rack Mount, Details

- Remove the four rubber feet from the bottom of the BrightEye NXT. To remove, apply side pressure with your thumb, the feet are held on with adhesive and will pop off.
- Choose the position in the rack for installation of the BrightEye NXT. Depending on the position, one or two NXT Retainer Washer(s) are needed to ensure proper retention in the rack.

To install a NXT in one of the end slots, remove the upper side screw on the side of the NXT that will face the center of the rack. Install the NXT Retainer Washer (E) in its place using a 4-40 x 7/16" screw provided in the rack mount kit.

To install a NXT in the center position, remove the upper side screws on both sides of the NXT and install NXT Retainer Washers (E) in both positions using the 4-40 x 7/16" screws provided in the rack mount kit.

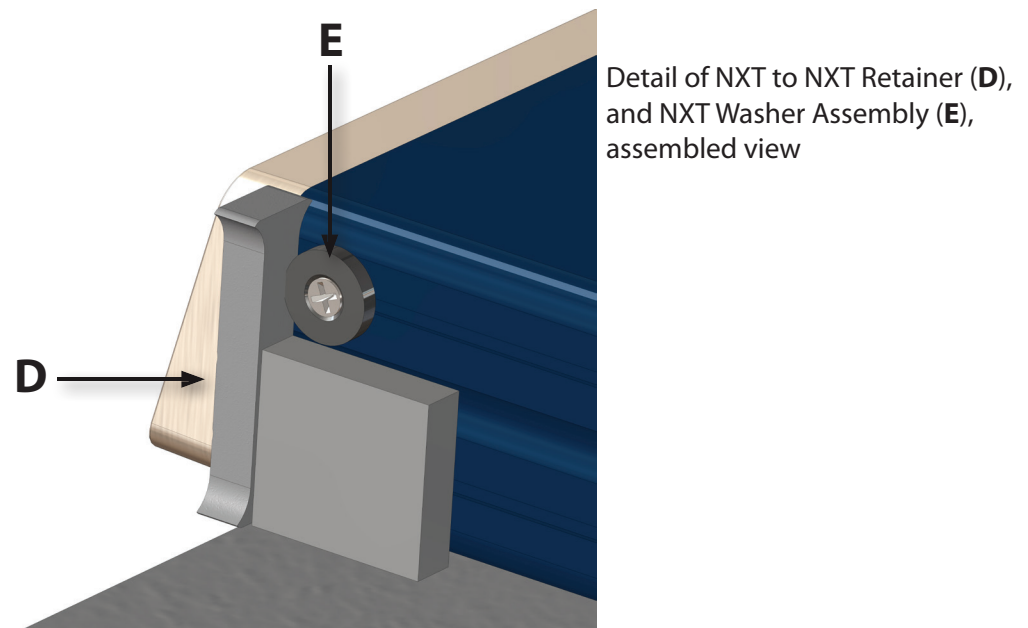
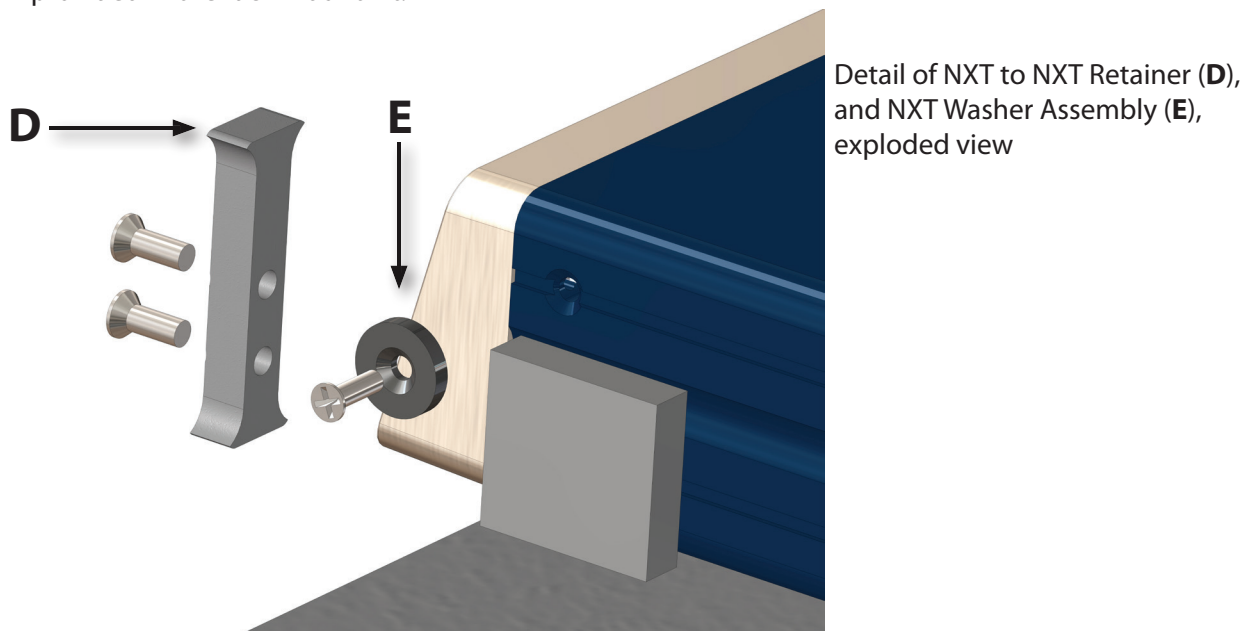

Installing a BrightEye NXT in the Rack Mount Details (continued)

- From the front, slide the NXT into position. The rear flange of the NXT will slide into the slots in the back of the rack mount.
- Choose the appropriate front retainer piece, and screw it into position with the 6-32 x 1/2" screws provided.

Note: Two each of three different front retainers are included in your rack kit in order to accommodate any combination of BrightEyes and NXTs. They are referred to by their associated letter in this document for simplicity, and are listed below. Close up illustrations are on page 5.

BrightEye to NXT Retainer (**B**)
BrightEye to BrightEye Retainer (**C**)
NXT to NXT Retainer (**D**), shown in below illustration

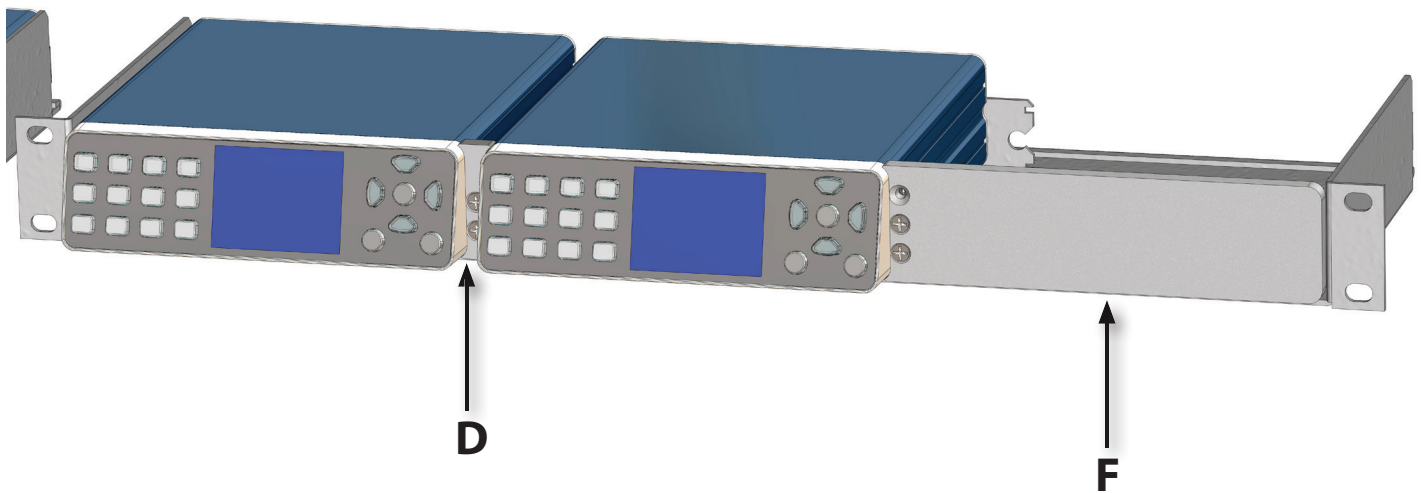

Illustration of two BrightEye NXTs installed in the rack mount, using a NXT to NXT front retainer (**D**), and a NXT Blank Filler Panel (**F**), assembled view

Installing a BrightEye in the Rack Mount

- From the front, slide the BrightEye into position. The rear flange of the BrightEye will slide into the slots in the back of the rack mount.

Note: Some models of BrightEyes are single-high and some are double-high. The 1RU height of the BrightEye Rack Mount accommodates double-high BrightEyes, or two single-high BrightEyes stacked as shown in the far left position of the illustration below. If you are installing just one single-high BrightEye in one of the positions and a fully dressed out rack is desired, a BrightEye single-high blank panel (BEBP) may be ordered to fill the open space.

- Choose the appropriate front retainer piece, and screw it into position with the 6-32 x 1/2" screws provided.

Note: Two each of three different front retainers are included in your rack kit in order to accommodate any combination of BrightEyes and NXTs. They are referred to by their associated letter in this document for simplicity, and are listed below. Close up illustrations are on page 5.

BrightEye to NXT Retainer (**B**)

BrightEye to BrightEye Retainer (**C**), shown in below illustration

NXT to NXT Retainer (**D**)

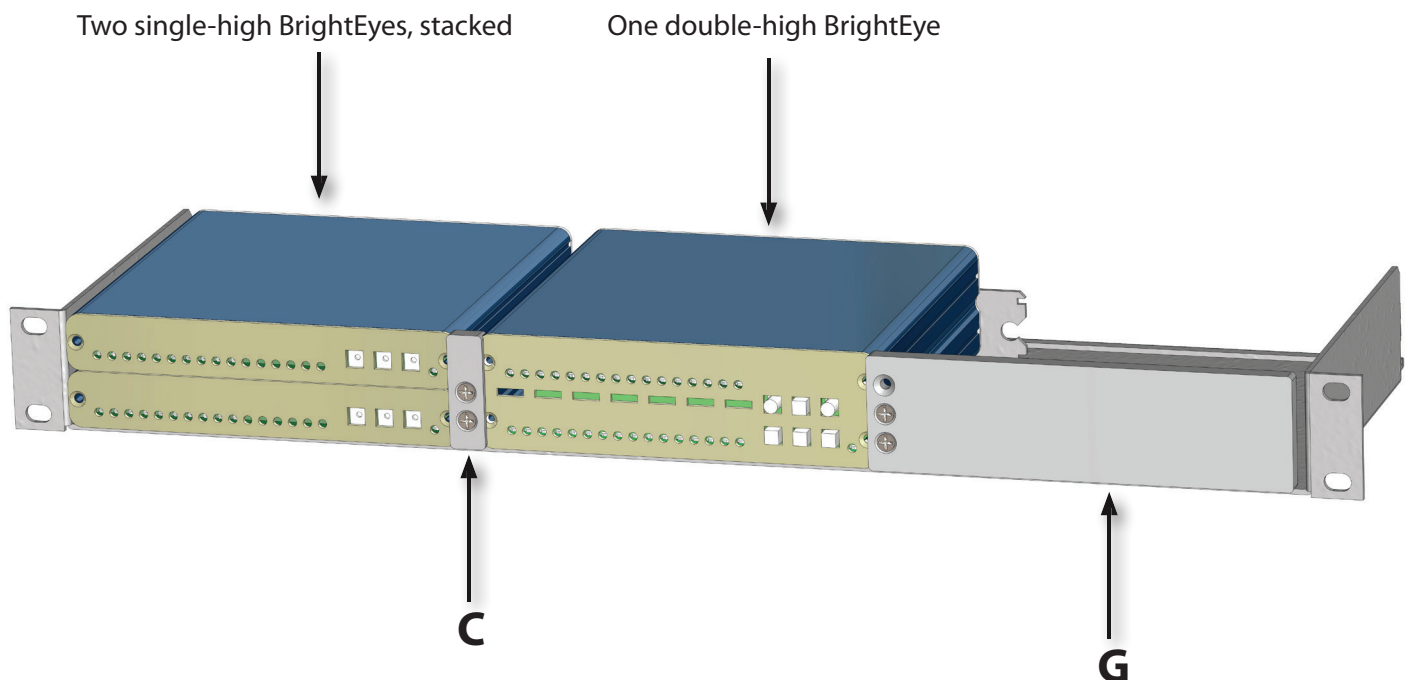

Illustration of BrightEyes installed in the rack mount, using a BrightEye to BrightEye front retainer (**C**), and a BrightEye Blank Filler Panel (**G**), assembled view

The below illustration is an example for installing a combination of BrightEyes and a BrightEye NXT in a rack mount.

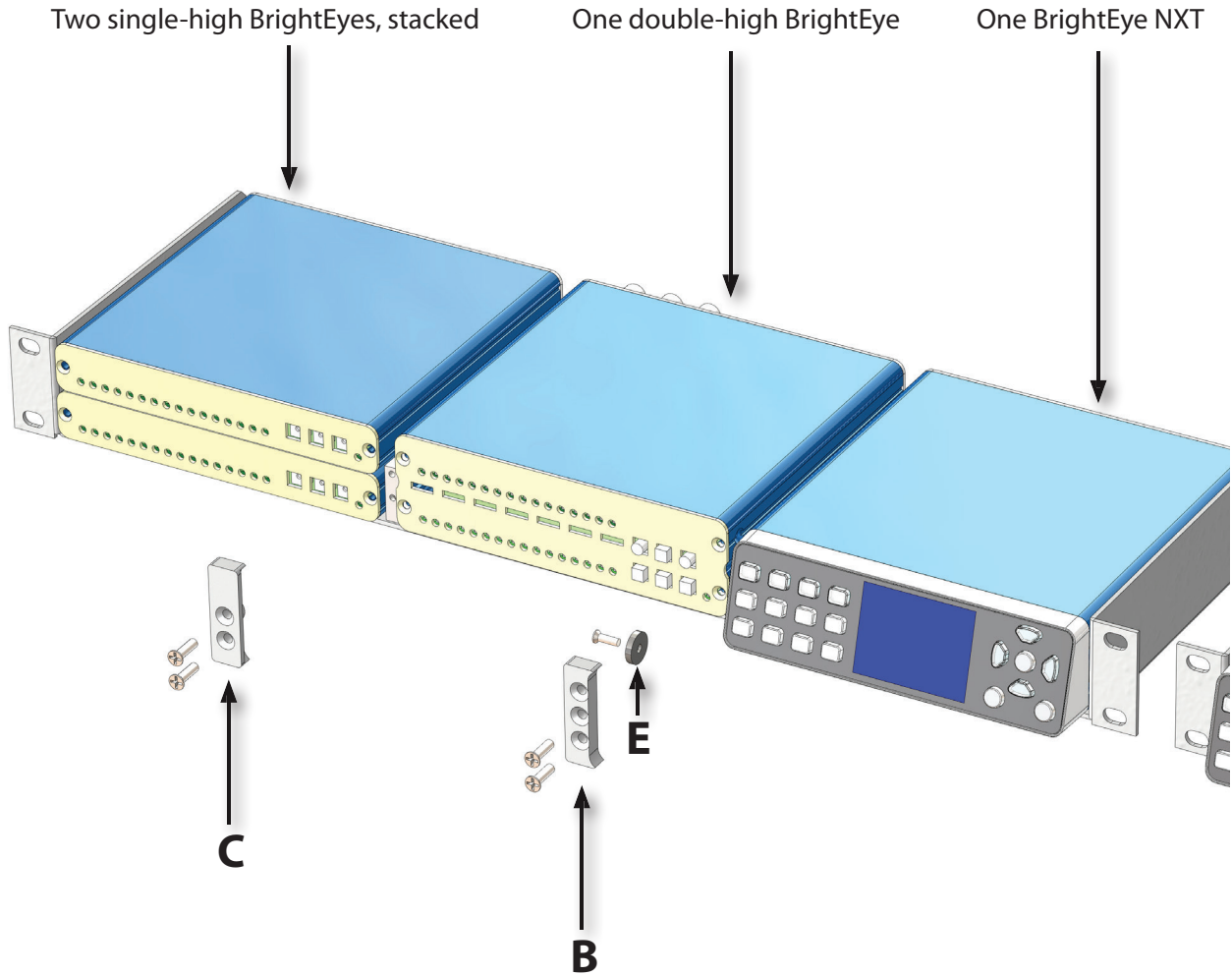
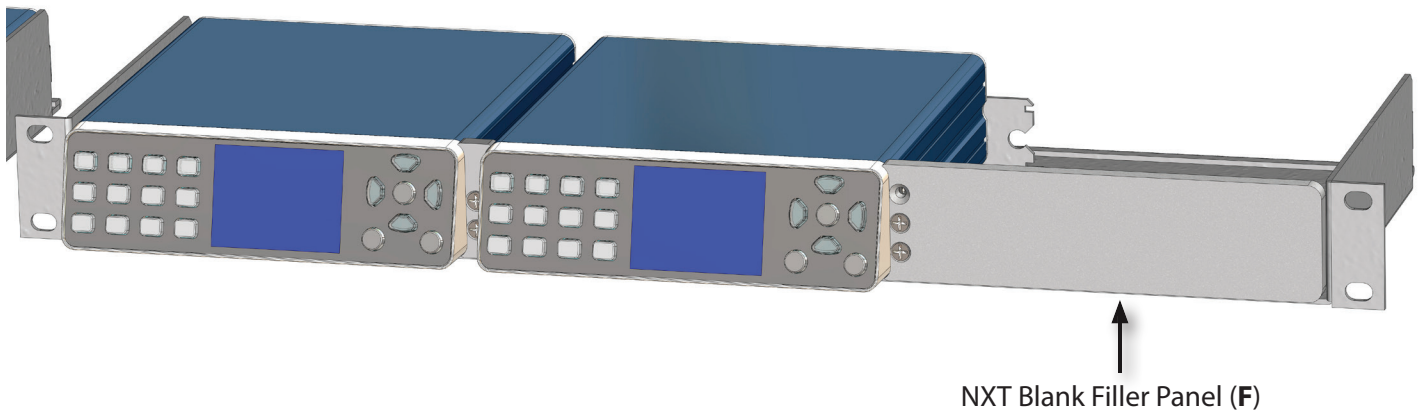

Illustration of BrightEyes and a BrightEye NXT installed in the rack mount, using a BrightEye to BrightEye front retainer (C), a BrightEye to NXT front retainer (B) and an NXT Retainer Washer (E), exploded view

Using Blank Filler Panels in the Rack Mount

For a complete, dressed out look, blank filler panels may be installed to fill unused space in the rack mount. Filler panels are purely cosmetic and are not required for rack stability or for proper retention of the units in the rack. Each BERKMT-FULL kit comes with two NXT blank filler panels and two BrightEye blank filler panels. BERKMT-RR kits do not include any blank filler panels.

The NXT blank filler panel and the BrightEye blank filler panel (both shown below) can be installed in any of the three positions in the rack mount. If you are installing just one single-high BrightEye in a position, a BrightEye single-high blank panel (BEBP) may be used to fill the remaining space (not shown and not included in BrightEye Rack Mount Kits). Details for ordering blank panels are on the following page.



Additional Parts Order Info

BrightEye Rack Mount Retainer Kit – BERK-RET

Quantity	Description	Reference Letter	Ensemble Designs Part Number
2	BrightEye to NXT Rack Mount Retainer	B	52002232
2	BrightEye to BrightEye Rack Mount Retainer	C	52002233
2	NXT to NXT Rack Mount Retainer	D	52002234
4	NXT Retainer Washer	E	52002236
4	6-32 x 1/2" Phillips Flat Black Z/P Machine Screw w/Nylock		30001147
4	4-40 x 7/16" Phillips Flat Machine Screw, Black Oxide		30001148

BrightEye Rack Mount Filler Panel Kit – BERK-BPKit

Quantity	Description	Reference Letter	Ensemble Designs Part Number
2	NXT Blank Filler Panel for the BrightEye Rack Tray	F	52002238
2	BrightEye Blank Filler Panel for the BrightEye Rack Tray	G	52002239
4	6-32 x 1/2" Phillips Flat Black Z/P Machine Screw w/Nylock		30001147

BrightEye Single-High Blank Panel – BEBP

BrightEye single-high blank panel – Ensemble Designs order info: BEBP

Troubleshooting

There's a gap between the blank filler panel and the side of rack mount

When the BrightEye Blank Filler Panel is installed in either the left or right position, there is an intentional gap between the Blank Filler Panel and the side of the rack mount.

My BrightEye NXT won't complete its power up cycle

BrightEye NXTs must be powered by their own product specific power supply that comes with each unit. This is a 5 amp single power supply, Ensemble Designs part number 23600106, order info: BEPS-NXT. DO NOT use a BrightEye Spider power supply (BEPS6) or a BrightEye Individual power supply (BEPS, ED part number 23118900) to power BrightEye NXTs.

Factory Service

If you return equipment for repair, please get a Return Material Authorization Number (RMA) from the factory first.

Ship the product and a written description of the problem to:

Ensemble Designs, Inc.
Attention: Customer Service RMA #####
870 Gold Flat Rd.
Nevada City, CA 95959 USA

tel +1 530.478.1830
fax +1 530.478.1832

service@ensembledesigns.com

www.ensembledesigns.com

Be sure to put your RMA number on the outside of the box.