

# iTrack Solo

## User Guide

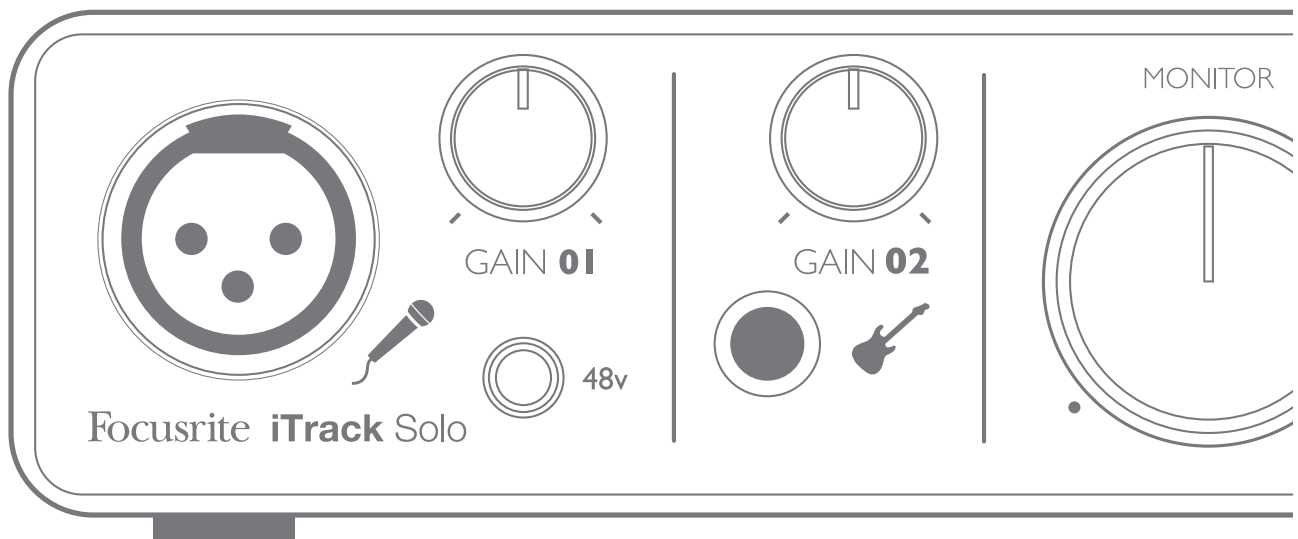

**Focusrite**<sup>®</sup>  
[www.focusrite.com](http://www.focusrite.com)

# IMPORTANT SAFETY INSTRUCTIONS

1. Read these instructions.
2. Keep these instructions.
3. Heed all warnings.
4. Follow all instructions.
5. Do not use this apparatus with water.
6. Clean only with dry cloth.
7. Do not install near any heat sources such as radiators, heat registers, stoves, or other apparatus (including amplifiers) that produce heat.
8. Protect the power cord from being walked on or pinched particularly at plugs, convenience receptacles, and the point where they exit from the apparatus.
9. Only use attachments/accessories specified by the manufacturer.
10. Use only with the cart, stand, tripod, bracket, or table specified by the manufacturer, or sold with the apparatus. When a cart is used, use caution when moving the cart/apparatus combination to avoid injury from tip-over.



11. Unplug this apparatus during lightning storms or when unused for long periods of time.
12. Refer all servicing to qualified service personnel. Servicing is required when the apparatus has been damaged in any way, such as power-supply cord or plug is damaged, liquid has been spilled or objects have fallen into the apparatus, the apparatus has been exposed to rain or moisture, does not operate normally, or has been dropped.
13. No naked flames, such as lighted candles, should be placed on the apparatus.

**WARNING:** Excessive sound pressure levels from earphones and headphones can cause hearing loss.

**WARNING:** This equipment must only be connected to USB 2.0 type ports.



**CAUTION:** TO REDUCE THE RISK OF ELECTRIC SHOCK, DO NOT REMOVE COVER (OR BACK). NO USER-SERVICEABLE PARTS INSIDE. REFER SERVICING TO QUALIFIED SERVICE PERSONNEL.



The lightning flash with arrowhead symbol, within equilateral triangle, is intended to alert the user to the presence of uninsulated “dangerous voltage” within the product’s enclosure that may be of sufficient magnitude to constitute a risk of electric shock to persons.



The exclamation point within an equilateral triangle is intended to alert the user to the presence of important operating and maintenance (servicing) instructions in the literature accompanying the appliance.

# ENVIRONMENTAL DECLARATION

## Compliance Information Statement: Declaration of Compliance procedure

Product Identification: Focusrite iTrack Solo  
Responsible party: American Music and Sound  
Address: 5304 Derry Avenue #C  
Agoura Hills,  
CA 91301  
Telephone: 800-994-4984

This device complies with part 15 of the FCC Rules. Operation is subject to the following two conditions: (1) This device may not cause harmful interference, and (2) this device must accept any interference received, including interference that may cause undesired operation.

### For USA

#### To the User:

1. **Do not modify this unit!** This product, when installed as indicated in the instructions contained in this manual, meets FCC requirements. Modifications not expressly approved by Novation may void your authority, granted by the FCC, to use this product.
2. **Important:** This product satisfies FCC regulations when high quality shielded cables are used to connect with other equipment. Failure to use high quality shielded cables or to follow the installation instructions within this manual may cause magnetic interference with appliances such as radios and televisions and void your FCC authorization to use this product in the USA.
3. **Note:** This equipment has been tested and found to comply with the limits for a Class B digital device, pursuant to part 15 of the FCC Rules. These limits are designed to provide reasonable protection against harmful interference in a residential installation. This equipment generates, uses and can radiate radio frequency energy and, if not installed and used in accordance with the instructions, may cause harmful interference to radio communications. However, there is no guarantee that interference will not occur in a particular installation. If this equipment does cause harmful interference to radio or television reception, which can be determined by turning the equipment off and on, the user is encouraged to try to correct the interference by one or more of the following measures:
  - Reorient or relocate the receiving antenna.
  - Increase the separation between the equipment and receiver.
  - Connect the equipment into an outlet on a circuit different from that to which the receiver is connected.
  - Consult the dealer or an experienced radio/TV technician for help.

### For Canada

#### To the User:

This Class B digital apparatus complies with Canadian ICES-003.

Cet appareil numérique de la classe B est conforme à la norme NMB-003 du Canada.

#### RoHS Notice

Focusrite Audio Engineering Limited has conformed and [its/this] product[s] conform[s], where applicable, to the European Union's Directive 2002/95/EC on Restrictions of Hazardous Substances (RoHS) as well as the following sections of California law which refer to RoHS, namely sections 25214.10, 25214.10.2, and 58012, Health and Safety Code; Section 42475.2, Public Resources Code.

# TABLE OF CONTENTS

<b>IMPORTANT SAFETY INSTRUCTIONS</b> .....	<b>2</b>
<b>TABLE OF CONTENTS</b> .....	<b>4</b>
<b>OVERVIEW</b> .....	<b>5</b>
Introduction .....	5
Features .....	5
Box Contents .....	5
System Requirements .....	6
Compatible iOS devices .....	6
Mac OS .....	6
Windows .....	6
<b>GETTING STARTED</b> .....	<b>7</b>
Using the iTrack Solo with an iOS device .....	7
Powering the iTrack Solo .....	7
Connections to your iOS device .....	7
Using the iTrack Solo with GarageBand .....	8
Using the iTrack Solo with a Mac or PC .....	9
Software Installation .....	9
Mac OS .....	9
Windows .....	10
Connecting your iTrack Solo .....	10
Audio setup in your DAW .....	10
Example of use .....	12
Connecting a microphone / instrument .....	12
Using Direct Monitoring .....	13
Headphone monitoring .....	13
Connecting iTrack Solo to loudspeakers .....	13
<b>HARDWARE FEATURES</b> .....	<b>14</b>
Front Panel .....	14
Back Panel .....	15
<b>PERFORMANCE SPECIFICATIONS</b> .....	<b>16</b>
Physical and Electrical Characteristics .....	17
<b>TROUBLESHOOTING</b> .....	<b>17</b>
<b>COPYRIGHT AND LEGAL NOTICES</b> .....	<b>17</b>

# OVERVIEW

## Introduction

Thank you for purchasing this iTrack Solo, one of the family of Focusrite professional computer audio interfaces incorporating high quality Focusrite analogue pre-amplifiers. You now have a simple and compact solution for routing high quality audio to and from your iPad, iPad 2, iPad (3rd Generation) or computer.

This User Guide provides a detailed explanation of the hardware to help you achieve a thorough understanding of the product's operational features. We recommend that both users who are new to computer-based recording, as well as more experienced users, take the time to read through the user guide so that you are fully aware of all the possibilities that the iTrack Solo has to offer. If the main User Guide sections do not provide the information you need, be sure to consult <http://www.focusrite.com/answerbase>, which contains a comprehensive collection of common technical support queries.

## Features

The iTrack Solo audio interface allows you to connect a microphone and/or guitar to an iPad, iPad 2 or iPad (3rd Generation). The signals connected to the physical inputs of the iTrack Solo can then be routed to your audio recording app - for example, GarageBand. It can also be used to route audio to a digital audio workstation (referred to throughout this user guide as a "DAW") running on a laptop (or desktop) using either Mac OS or Windows. In either case, the monitoring output from the recording app or DAW will appear at the iTrack Solo's physical outputs.

This lets you record "real-world" instruments into GarageBand (or whichever recording app or DAW you use) along with - or instead of - any "native" sounds already available within your iOS device or computer. The instruments may be "electric", i.e., a guitar, or acoustic - anything you can put a microphone in front of. The iTrack Solo also lets you route the tracks of your DAW to its physical outputs, which can be connected to an amplifier and speakers, powered monitors, headphones, or any other audio equipment with analogue inputs that you wish to use. Although all inputs and outputs on the iTrack Solo are routed directly to and from your DAW for recording and playback, you can configure the routing within your DAW in order to meet your needs.

## Box Contents

Along with your iTrack Solo you should have:

- Software activation card providing activation codes for:
  - Focusrite Scarlett Plug-in Suite
  - Ableton Live Lite
- Device Link cable (iTrack Solo to iPad)
- USB cable (Type 'A' to Type 'B')
- Getting Started Guide

## **System Requirements**

### **Compatible iOS devices:**

iPad, iPad 2, iPad (3rd generation)

### **Mac OS**

Apple Macintosh with a high-speed USB 2.0-compliant USB port  
OS: Mac OS X 10.7 or later (Lion or Mountain Lion)

### **Windows**

Windows compatible computer with a USB 2.0-compliant USB port  
OS: Windows 7

# GETTING STARTED

## Using the iTrack Solo with an iOS device

### Powering the iTrack Solo

The iTrack Solo is an active device, and needs a DC power source to operate. It is important to remember that when you use the iTrack Solo with an iPad, it will not be powered from the iOS device via the interface cable.

Use the supplied USB cable to connect the iTrack Solo to a standard Apple USB Power Supply (or other standard USB power supply). One of these is supplied with every iOS device, or can be obtained separately. The front panel USB LED (7) will illuminate when the iTrack Solo is powered and connected.

It is also important to note that when connected in this way, the iTrack Solo will not charge the iOS device's internal battery.

### Connections to your iOS device

The supplied iOS interface cable should be connected between the DEVICE LINK port on the rear of the iTrack Solo and your iPad. This cable will carry the audio between the recording app on your iOS device and the iTrack Solo in both directions, but does **not** carry DC power in either direction (see above).

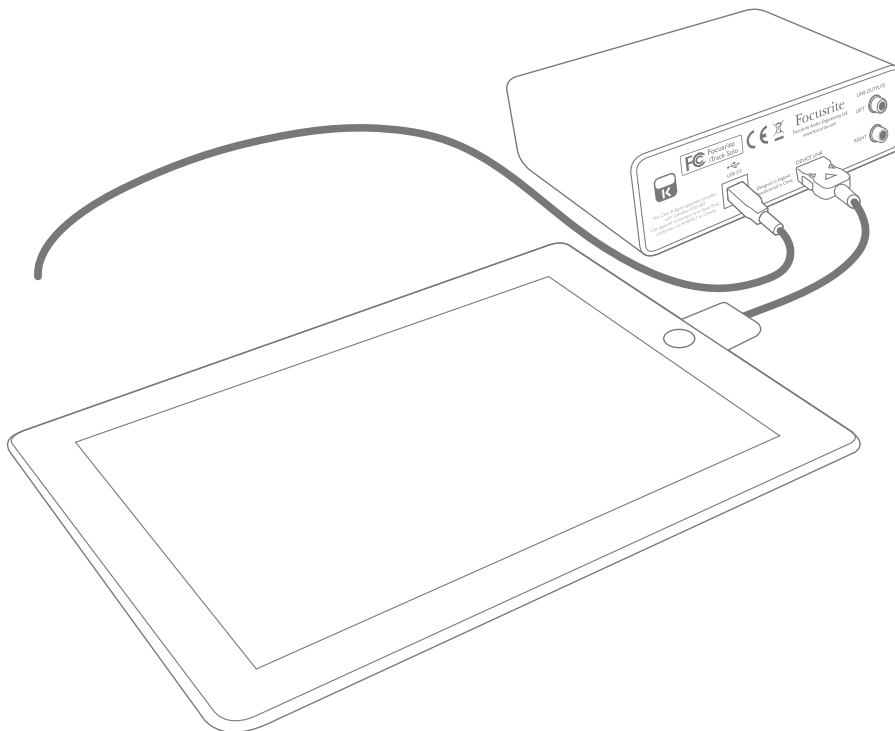

See “Example of use” on page 12 for details of how to connect audio sources and monitoring systems to the iTrack Solo.

NOTE: When using the iTrack Solo with an iPad, please enable “Airplane Mode” in the settings menu to avoid experiencing any interference during recording and playback.

## Using the iTrack Solo with GarageBand

GarageBand is one of the most popular recording apps for iOS devices. It is a useful compositional tool and used on its own, allows you to create music from the range of virtual instruments it provides. With iTrack Solo, you can add vocals and real-world instruments as well.

To route the iTrack Solo mic input into GarageBand follow the procedure below (operating instructions for GarageBand are beyond the scope of this User Guide, but the application includes a full set of Help files):

1. Open the GarageBand song you are working on.
2. Create a vocal track by tapping the '+' button on the bottom left-hand corner of the screen and select Audio Recorder.
3. Tap the jack plug icon  to open the Input Settings controls.
4. Select **Left Channel** to route the mic input to the vocal track.
5. Switch Monitor **OFF** and enable Direct Monitor (8) on the iTrack Solo. See "Using Direct Monitoring" on page 13 for further details on the benefits of using iTrack's Direct Monitor feature.



To record a guitar, follow the procedure below:

1. Open the GarageBand song you are working on.
2. Create a guitar track by tapping the '+' button on the bottom left-hand corner of the screen, select Guitar Amp Track and scroll to select the desired Amp model to be used.
3. Tap the jack plug icon to open the Input Settings controls.
4. Select **Right Channel** to route the instrument input to the guitar track.
5. You can use either the internal monitor within GarageBand or the Direct Monitor feature on the iTrack Solo.



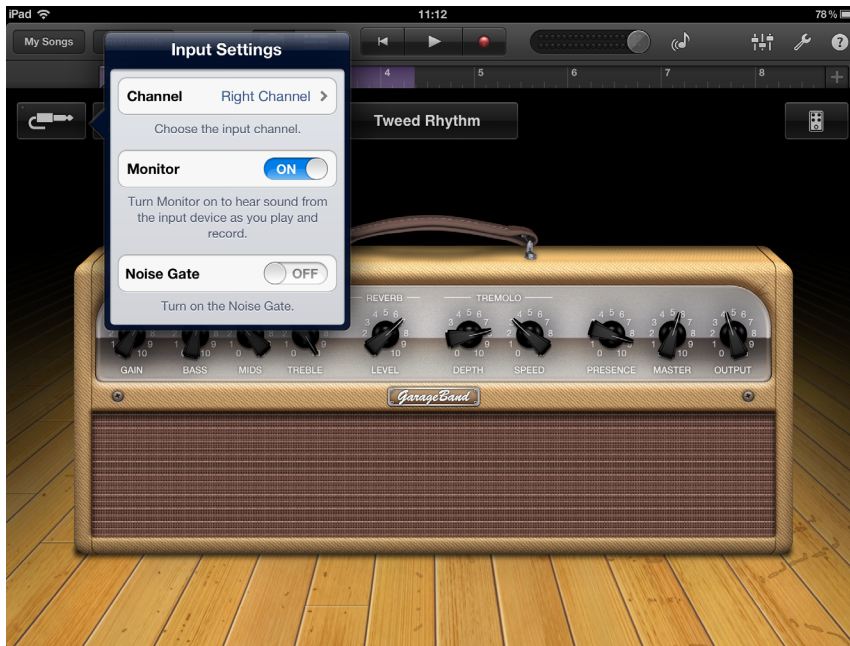

If you are using a different recording app, a similar procedure will be necessary; check the App's Help files for information.

## Using the iTrack Solo with a Mac or PC

You can also use your iTrack Solo as an analogue audio I/O (Input-Output) interface to a laptop (or other computer). This will let you record tracks on your DAW from a microphone, guitar, etc., and also let you connect loudspeaker or headphone monitoring, so you can hear your work in progress through an external audio system.

### Software Installation

You will need to install the appropriate drivers onto your laptop/computer before you can use the iTrack Solo with it. (Drivers are small software applications which ensure that your laptop/computer communicates correctly and efficiently with the iTrack Solo).

The drivers can be downloaded from [www.focusrite.com/downloads](http://www.focusrite.com/downloads). Navigate to the iTrack Solo download area.

### Mac OS

Select the Mac disk image (\*.dmg) version of the driver to start the download. Double-click the file from the Downloads folder and then run the installation package (\*.pkg). Follow all on-screen instructions; a confirmation will be given when the driver has been installed successfully.

Your OS should automatically switch the computer's default audio outputs to be the USB port to which the iTrack Solo is connected. To verify this, go to System Preferences > Sound, and set the input and output to iTrack Solo. For more detailed setup options on a Mac, open Applications > Utilities > Audio MIDI Setup.

## Windows

Double-click the Windows (\*.exe) version to start the download. Save the file to a convenient location, and when the download has completed, double-click it. Follow all on-screen instructions; a confirmation will be given when the driver has been installed successfully.

Restart your laptop/computer, and then connect the iTrack Solo to a USB port using the supplied cable.

Your OS should automatically switch the computer's default audio outputs to be the USB port to which the iTrack Solo is connected. To verify this:

on Windows 7 - go to Start > Control Panel > Hardware and Sound > Sound > Manage Audio Devices and set 'Default Playback' and 'Recording' to 'iTrack Solo'.

## Connecting your iTrack Solo

**IMPORTANT:** Before you connect the iTrack Solo to your computer, please complete the software installation according to the instructions above. This will ensure that the hardware uses the correct drivers, and will prevent unexpected behaviour.

The iTrack Solo has a single USB 2.0 port (on the rear panel). Once the software installation is complete, simply connect the iTrack Solo to your computer using the USB cable provided. (Note that iTrack Solo is a USB 2.0 device, and thus the USB connection requires a USB 2.0+ compliant port on your computer. It will not operate correctly with USB 1.0/1.1 ports.) The iTrack Solo will be powered from the computer via the USB connection.

The iTrack Solo cannot be used with an iOS device and a computer at the same time. If this is attempted, the iOS device will assume priority, and the iTrack Solo will no longer be available as the I/O device for the computer DAW application.

## Audio setup in your DAW

The iTrack Solo is compatible with any Windows-based DAW that supports ASIO or WDM and any Mac-based DAW that uses Core Audio. After installing the driver and connecting the hardware, you can start using the iTrack Solo with the DAW of your choice. Ableton Live Lite may easily be downloaded from [www.ableton.com/live-lite](http://www.ableton.com/live-lite) if you do not already have a DAW application installed on your computer. A card with an activation code is included in the box.

Operating instructions for Ableton Live Lite are beyond the scope of this User Guide, but the application includes a full set of Help files.

Please note - your DAW may not automatically select the iTrack Solo as its default I/O device. In this case, you must manually select 'iTrack Solo' (or 'Focusrite USB 2.0 driver') as the driver on your DAW's **Audio Setup**\* page. Please refer to your DAW's documentation (or Help files) if you are unsure where to select the ASIO/ Core Audio driver. The following example shows the correct configuration in the Ableton Live Lite **Preferences** panel (Mac version shown).



Once the iTrack Solo is set as the preferred Audio Device\* in your DAW, Inputs 1 & 2 and Outputs 1 & 2 will appear in your DAW's Audio I/O preferences. Depending on your DAW, you may need to enable certain inputs or outputs before use. The two examples below show Inputs 1 & 2 and Outputs 1 & 2 enabled in the Ableton Lite Audio Preferences.

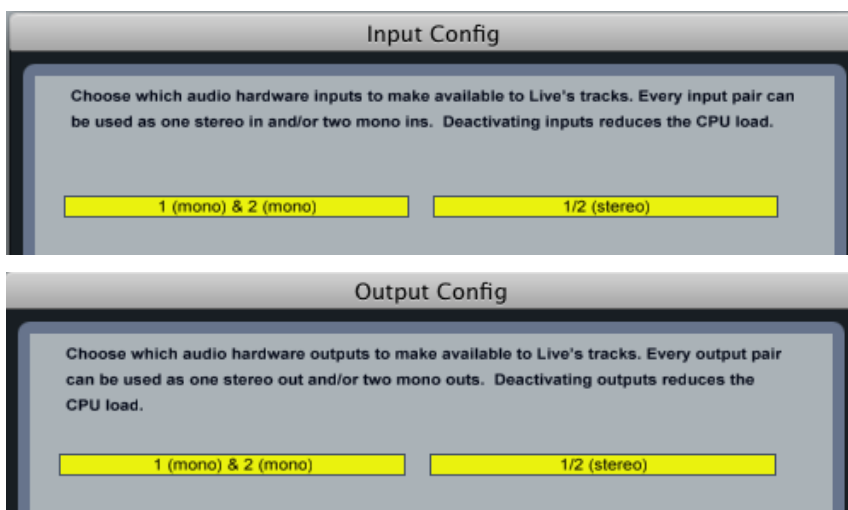

\*Typical name. Terminology may differ slightly between DAWs.

## Example of use

The iTrack Solo is the ideal interface for an iPad or a DAW application on a laptop or other computer.

A typical set of connections is illustrated below:

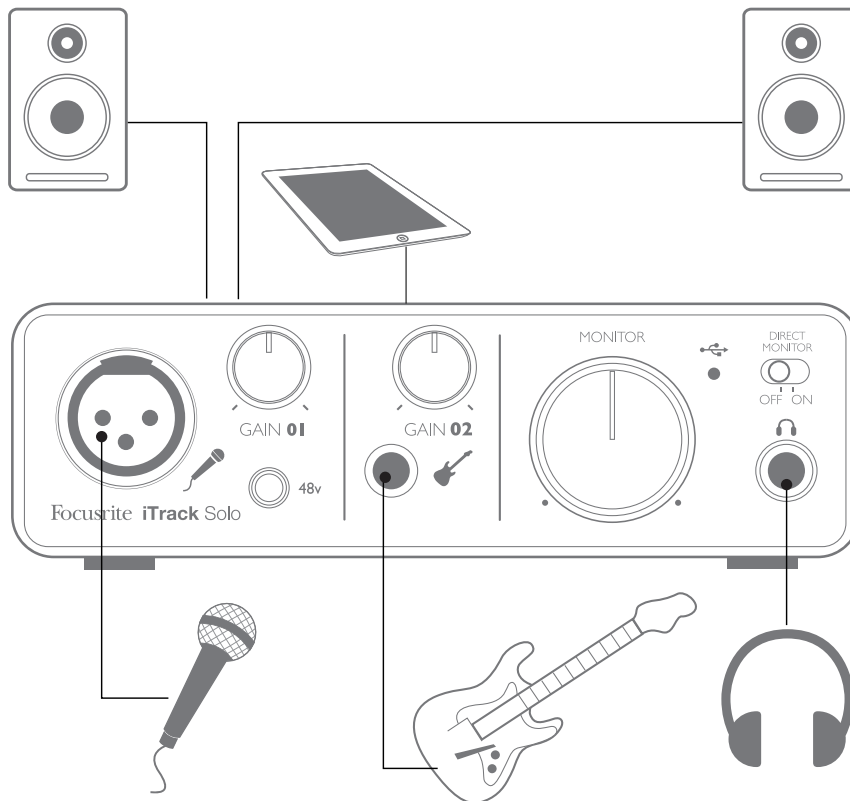

### Connecting a microphone / instrument

This setup illustrates a typical configuration for recording – either into your iOS device, or by using DAW software on your Mac or PC. In this case, you might record vocals through Input 1 and guitar through Input 2 into your recording application, while monitoring the playback via headphones or loudspeakers.

The iTrack Solo's inputs are on the front panel; Input 1 uses a standard 3-pin XLR socket, and is configured to work with microphones of most types; you will probably have a mating XLR male connector on the end of your mic cable. Input 2 uses a 2-pole 1/4" (6.35 mm) jack socket, and is intended to accept signals from a guitar or bass.

If you are using a "studio" condenser (capacitor) microphone designed to operate on 48 V phantom power, press the **48V** button. Other types of microphone (including the common dynamic type) do not require phantom power, and may suffer damage if phantom power is applied. Some cheaper condenser microphones are able to operate from a lower phantom power voltage – typically 15 V. You should check the mic spec to see if it is safe to operate it from 48 V; if not, obtain a suitable external phantom power supply.

## Using Direct Monitoring

You will frequently hear the term “latency” used in connection with digital audio systems. In the case of the simple recording application described above, latency will be the time it takes for your input signals to pass through your recording device (laptop or iPad, etc.) and the associated software. Latency can be a problem for a performer who wishes to record while monitoring their input signals.

The iTrack Solo is fitted with a “Direct Monitoring” option, which overcomes this problem. Setting the front panel **DIRECT MONITOR** switch to ON will route your input signals directly to the iTrack Solo’s headphone and main monitor outputs. This enables you to hear yourself with zero latency – i.e., in “real time” – along with the computer playback. The input signals to your computer are not affected in any way by this setting.

When “Direct Monitoring” is set to ON, ensure that your recording software is not set to route its input (what you are currently recording) to its output. If it is, you will hear yourself “twice”, with one signal audibly delayed as an echo.

## Headphone monitoring

Connect a pair of stereo headphones to the front panel headphones socket to hear both what you are recording (your current input signal(s)) and any tracks you’ve already recorded in your laptop or iOS device. The pre-recorded tracks will be heard in stereo, and the current input signals in mono – central in the stereo image. If you are using both the mic and instrument inputs, the two inputs will be summed in mono.

## Connecting iTrack Solo to loudspeakers

The phono (RCA) outputs on the rear panel can be used to connect monitoring speakers. Self-powered monitors (i.e., typical computer speakers) incorporate internal amplifiers, and may be connected directly. Larger, passive loudspeakers will require a separate stereo amplifier; in this case, the rear panel outputs should be connected to the amplifier’s inputs.

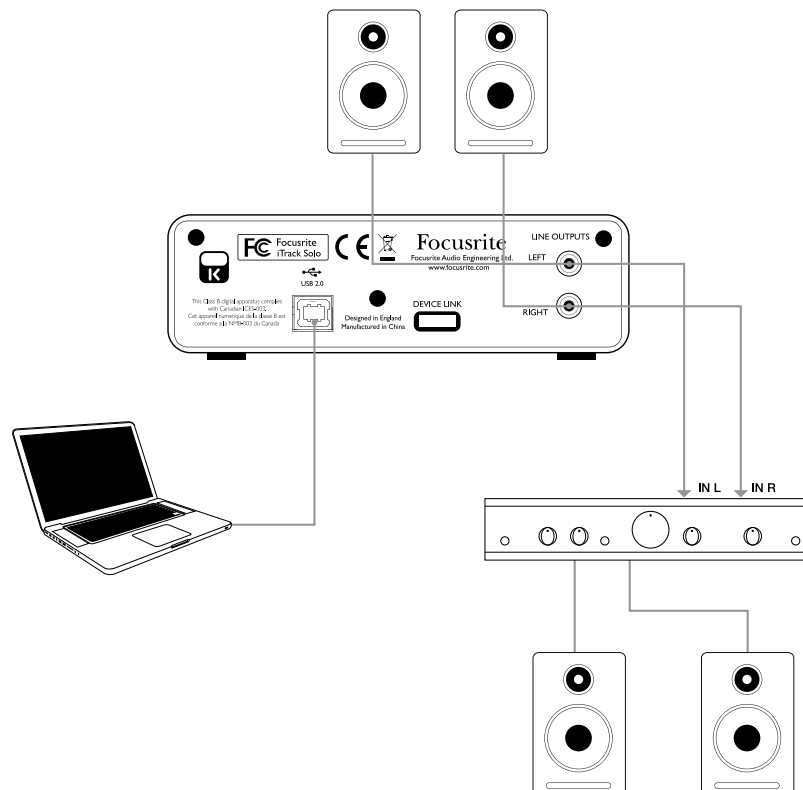

The line output connectors are standard phono (RCA) sockets. Typical consumer (hi-fi) amplifiers and small powered monitors will have inputs on phono (RCA) sockets or a single 3.5 mm 3-pole jack plug (intended for direct connection to a computer). In either case, use a suitable connecting cable with phono plugs (RCA jacks) at one end.

NOTE: You run the risk of creating an audio feedback loop if loudspeakers are active at the same time as a microphone! We recommend that you always turn off (or turn down) monitoring loudspeakers while recording, and use headphones when overdubbing.

## HARDWARE FEATURES

### Front Panel

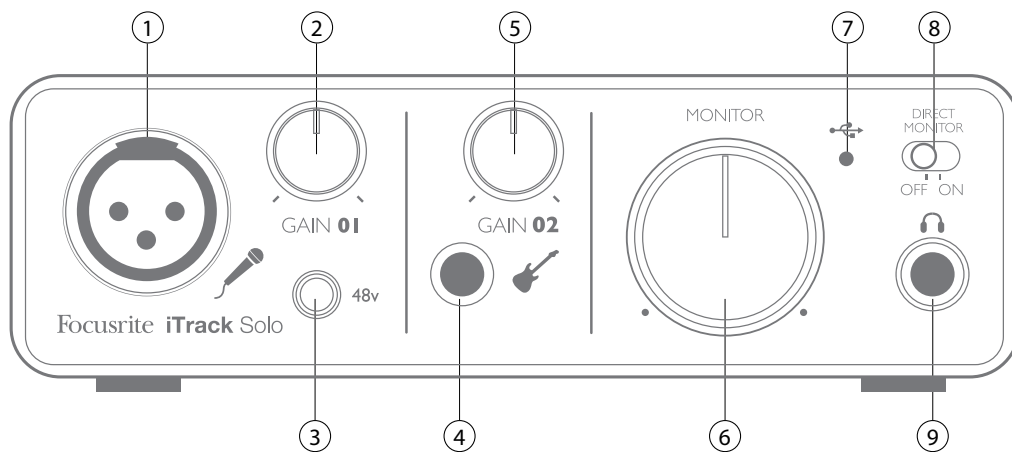

The front panel includes the input connectors for mic and instrument signals, and the input gain and monitoring controls.

1. **Input 1** - electronically balanced input via 3-pin XLR socket for microphones.
2. **GAIN 01** - adjust the gain for the microphone signal on input 1. The gain control has a concentric bi-colour LED 'ring' to confirm signal level: green indicates an input level of at least -24 dBFS (i.e., 'signal present'), the ring then turns red when signal level reaches 0 dBFS.
3. **48V** - phantom power switch for mic input - enables 48 V phantom power at the XLR socket.
4. **Input 2** - unbalanced input for connecting instruments; 1/4" TS jack socket.
5. **GAIN 02** - adjust the gain for the instrument signal on input 2.
6. **MONITOR** - main monitor output level control - sets the output level at the main (rear panel) outputs 1 & 2 and the front panel headphone output.
7. **USB LED** - illuminates when the unit is connected and receives power via the USB connection.
8. **DIRECT MONITOR** - selects monitoring of input signals to be directly from inputs (On) or via DAW (Off).
9. **Headphone socket** - 1/4" TRS output jack - connect your stereo headphones here.

## Back Panel

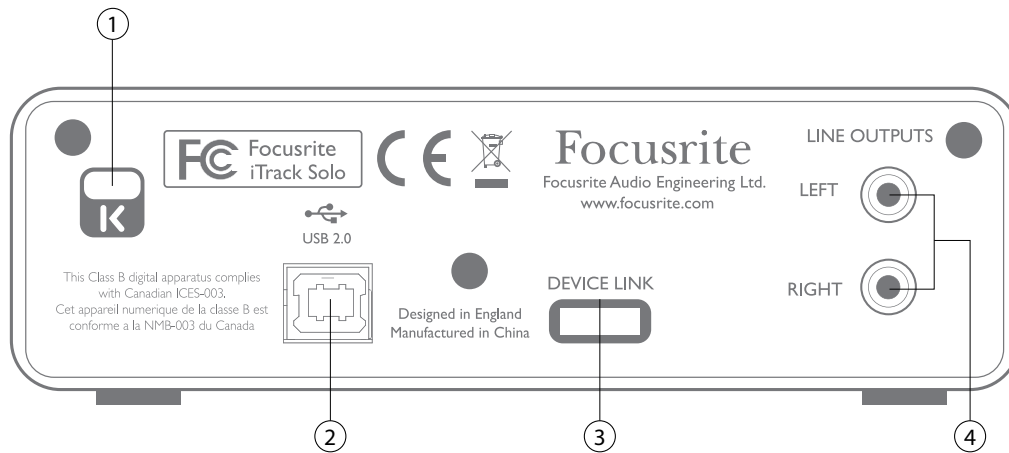

1. **Kensington security lock** - secure your iTrack Solo to a suitable structure if desired.
2. **USB 2.0 port** - Type B connector; connect to your laptop or desktop with cable supplied. You will need to connect this port to an Apple USB Power Supply when using the iTrack Solo with an iOS device.
3. **DEVICE LINK** - proprietary connector; use the cable supplied to connect this port to your iPad.
4. **LINE OUTPUTS** - 2 x phono (RCA) sockets; +8 dBV max. output level.

## PERFORMANCE SPECIFICATIONS

Clock source:	Internal
ADC Dynamic Range	105 dB 'A-weighted' (all inputs). Converter chipset A/D dynamic range 114 dB
DAC Dynamic Range	Range 105 dB 'A-weighted' (all outputs). Converter chipset D/A dynamic range 114 dB
Supported Sample Rates	44.1 kHz, 48 kHz, 88.2 kHz, 96 kHz / 24 bit – for Mac and PC 44.1 kHz, 48 kHz / 16 bit – operation with iPad. 24 bit audio available on playback only with iPad.
<b>Microphone Input 1</b>	
Frequency Response	20 Hz – 20 kHz +/- 0.2 dB
Gain Range	+ 10 dB to + 55 dB
THD+N	<0.002% (minimum gain, -1 dBFS input with 20 Hz – 22 kHz bandpass filter)
Noise EIN	<-120 dBu (measured at 55 dB gain with 150 ohm termination and 20 Hz – 22 kHz bandpass filter)
Input Impedance	3 kohms
<b>Instrument Input 2</b>	
Frequency Response	20 Hz – 20 kHz +/- 0.2dB
Gain Range	+10 dB to +55 dB
THD+N	0.003% (measured with -1 dBFS input and 20 Hz – 22 kHz bandpass filter)
Noise	-87 dBu (20 Hz – 22 kHz bandpass filter)
Input Impedance	>500 kohms
<b>Line Outputs 1 &amp; 2</b>	
Maximum Output Level (0 dBFS)	+9 dBu, unbalanced
THD+N	<0.001% (measured with 0 dBFS input and 20 Hz – 22 kHz bandpass filter, un-weighted).



## Physical and Electrical Characteristics

<b>Analogue Input 1</b>	
Connector	Balanced, via female 3-pin XLR on front panel
Phantom power	48 V phantom power switch
<b>Analogue Input 2</b>	
Connector	Unbalanced, via ¼" (6.35 mm) 2-pole jack socket on front panel
<b>Analogue Outputs</b>	
Main outputs	Unbalanced, via 2 x phono (RCA) sockets on rear panel
Stereo headphone output	¼" TRS jack on front panel
Headphone output power	16 mW into 50 ohms
Output level control (main and headphone)	On front panel
Direct Monitoring	Front panel switch; allows zero-latency monitoring of inputs
<b>Other I/O</b>	
USB	1 x USB 2.0 Type B connector
Device Link	10-pin (proprietary)
<b>Front Panel Indicators</b>	
USB	LED (green); indicates active USB connection
Gain controls	Colour-coded LED rings: green (-24 dBFS) and red (0 dBFS)
<b>Weight and Dimensions</b>	
W x H x D	150mm x 45mm x 100mm
Weight	0.5 Kg

## TROUBLESHOOTING

For all troubleshooting queries, please visit the Focusrite Answerbase at [www.focusrite.com/answerbase](http://www.focusrite.com/answerbase), where you will find articles covering numerous troubleshooting examples.

## COPYRIGHT AND LEGAL NOTICES

Focusrite iTrack Solo is a trademark of Focusrite Audio Engineering Limited registered in the UK and other countries.

iPad, iPhone and iPod touch are trademarks of Apple Inc., registered in the U.S. and other countries.

All other trademarks and trade names are the property of their respective owners.

2012 © Focusrite Audio Engineering Limited. All rights reserved.