

WB-X Wall Box

Large Capacity Wall Boxes

FSR

Metal Products Group

WB-X Wall Box

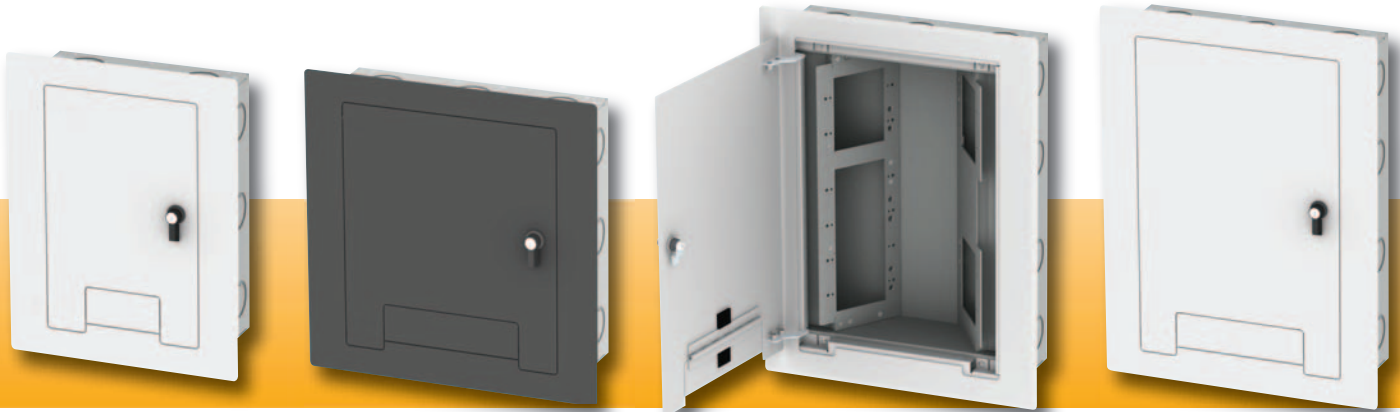

DESCRIPTION

The new WB-X wall box series is the latest addition to FSR's metal product line. These rugged all steel housings are available with either black or white locking covers. Two different style locksets are included to cover a variety of installation possibilities. The stylish covers have "flip up" cable entry doors so the door can be closed and locked once the cables are connected. Two door styles are available that will allow for either flush "in wall" or surface "on wall" mounting. The door hinges and mounting screws are hidden to provide security and for a sleek look.

There are four back box styles that are currently available in three different connector capacities for a total of twelve possible configurations. The internal connector mounting plate styles handle either standard gang plates, FSR's huge assortment IPS inserts or "XLR" type connectors. The mounting plates are height adjustable.

The WB-X "gang" style back boxes include factory mounted moveable high voltage dividers so that compartments containing AC line power can be isolated from low voltage and signal areas. Multiple gang arrangements are accomplished with a combination of supplied moveable dividers and spacer/filler panels. The WB-X IPS and XLR style back boxes have tapped holes on the connector mounting plates for easy connector mounting and are painted black.

All back boxes include installation brackets for mounting in old or new construction.

Ordering is simple: Specify the back box size and type. Then choose the cover color and matching size. (See the drawings and charts on the following pages for specific details and configurations.)

FEATURES

- Safe, secure cable, connector, and control management
- Low profile cover with locking door
- Locking cover door
- Back boxes can be ordered with or without knockouts
- New and old work compatible
- Fits within standard wall dimensions
- Tapped connector mounting holes ease installation
- Large 1", 1 1/4" Knockouts for conduit
- Choice of black or white covers
- IPS and XLR style connector plates are painted black and have room for customer provided ID name plate
- Support wings are included with back boxes for old and new work installation.
- Large selection of models and sizes
- Two lockset styles included:



Lock with handle

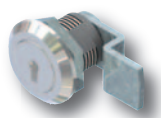

Flush lock without handle

APPLICATIONS

Schools, Hotels, Conference Centers, Airports, Arenas, Houses of Worship.

FSR

244 Bergen Boulevard, Woodland Park, NJ 07424
Phone: 973.785.4347 · Fax: 973.785.4207
Web: www.fsrinc.com · E-mail: sales@fsrinc.com

LIT1227C

WB-X1

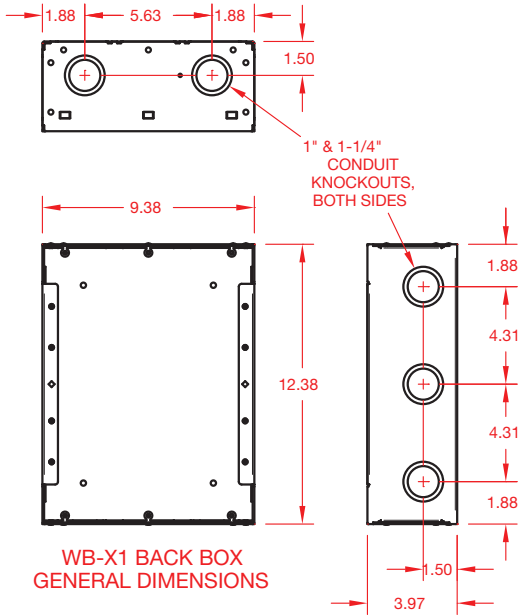

WB-X1 BACK BOX
GENERAL DIMENSIONS

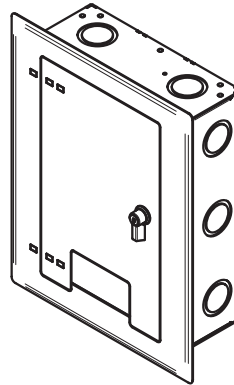

WB-X1-CVR
FLUSH-MOUNTED COVER
(SHOWN WITH BACK BOX)

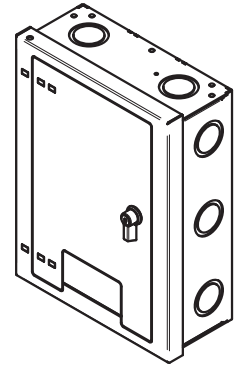

WB-X1-SMCVR
SURFACE MOUNTED COVER
(SHOWN WITH BACK BOX)

MODEL	FEATURES
WB-X1-GNG	BACK BOX, (1) 4 GANG OPENING w/KO'S
WB-X1-IPS	BACK BOX, (16) IPS SLOTS, 2 ROWS OF 8 IPS SLOTS w/KO's
WB-X1-PLT	BACK BOX ONLY w/KO's
WB-X1-XLR	BACK BOX, (15) XLR HOLES, 3 ROWS OF 5 XLR HOLES w/KO's
WB-X1NK-GNG	BACK BOX, (1) 4 GANG OPENING w/o KO'S
WB-X1NK-IPS	BACK BOX, (16) IPS SLOTS, 2 ROWS OF 8 IPS SLOTS w/o KO's
WB-X1NK-PLT	BACK BOX ONLY w/o KO's
WB-X1NK-XLR	BACK BOX, (15) XLR HOLES, 3 ROWS OF 5 XLR HOLES w/o KO's
WB-X1-CVR-BLK	LOCKING COVER, BLACK
WB-X1-CVR-WHT	LOCKING COVER, WHITE
WB-X1-SMCVR-BLK	LOCKING COVER, BLACK (SURFACE MOUNT)
WB-X1-SMCVR-WHT	LOCKING COVER, WHITE (SURFACE MOUNT)

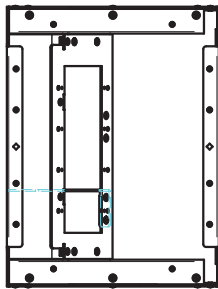

WB-X1-GNG
BACK BOX

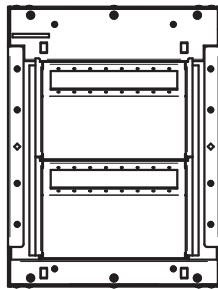

WB-X1-IPS
BACK BOX

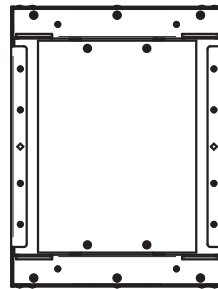

WB-X1-PLT
BACK BOX

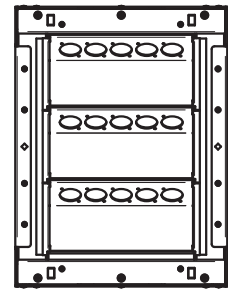

WB-X1-XLR
BACK BOX

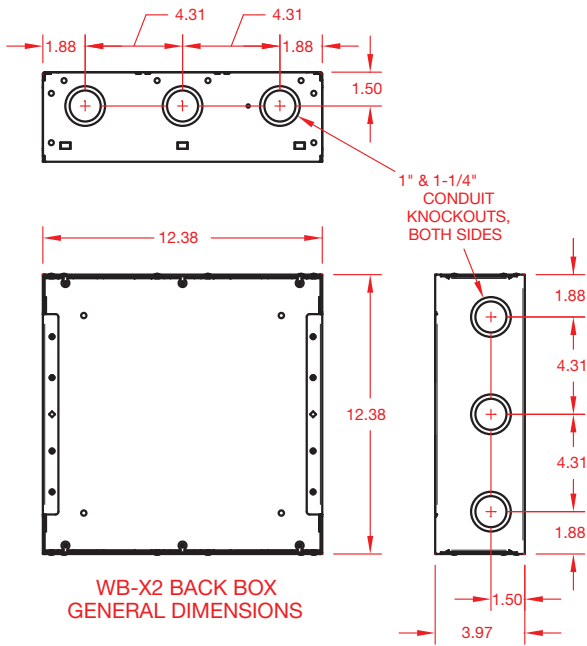

**WB-X2 BACK BOX
GENERAL DIMENSIONS**

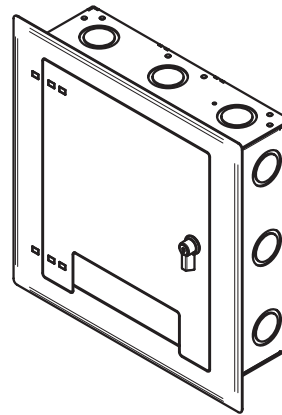

**WB-X2-CVR
FLUSH-MOUNTED COVER
(SHOWN WITH BACK BOX)**

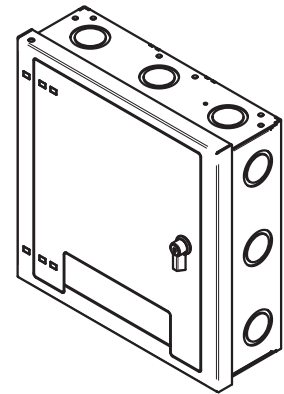

**WB-X2-SMCVR
SURFACE MOUNTED COVER
(SHOWN WITH BACK BOX)**

MODEL	FEATURES
WB-X2-GNG	BACK BOX, (2) 1 GANG AND (1) 4 GANG OPENINGS IN 2 ROWS w/KO's
WB-X2-IPS	BACK BOX, (24) IPS SLOTS, 2 ROWS OF 12 IPS SLOTS w/KO's
WB-X2-PLT	BACK BOX ONLY w/KO's
WB-X2-XLR	BACK BOX, (24) XLR HOLES, 3 ROWS OF 8 XLR HOLES w/KO's
WB-X2NK-GNG	BACK BOX, (2) 1 GANG AND (1) 4 GANG OPENINGS IN 2 ROWS w/o KO's
WB-X2NK-IPS	BACK BOX, (24) IPS SLOTS, 2 ROWS OF 12 IPS SLOTS w/o KO's
WB-X2NK-PLT	BACK BOX ONLY w/o KO's
WB-X2NK-XLR	BACK BOX, (24) XLR HOLES, 3 ROWS OF 8 XLR HOLES w/o KO's
WB-X2-CVR-BLK	LOCKING COVER, BLACK
WB-X2-CVR-WHT	LOCKING COVER, WHITE
WB-X2-SMCVR-BLK	LOCKING COVER, BLACK (SURFACE MOUNT)
WB-X2-SMCVR-WHT	LOCKING COVER, WHITE (SURFACE MOUNT)

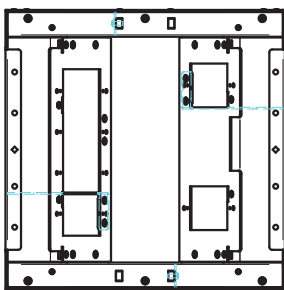

**WB-X2-GNG
BACK BOX**

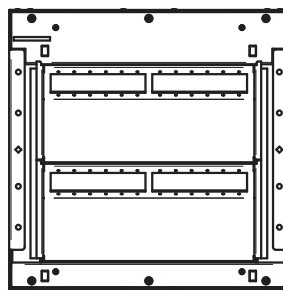

**WB-X2-IPS
BACK BOX**

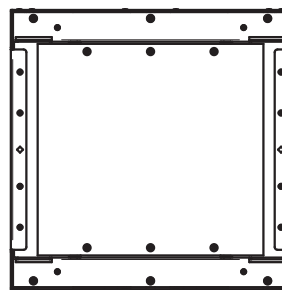

**WB-X2-PLT
BACK BOX**

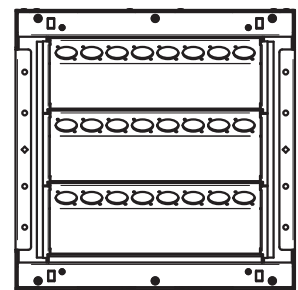

**WB-X2-XLR
BACK BOX**

WB-X3

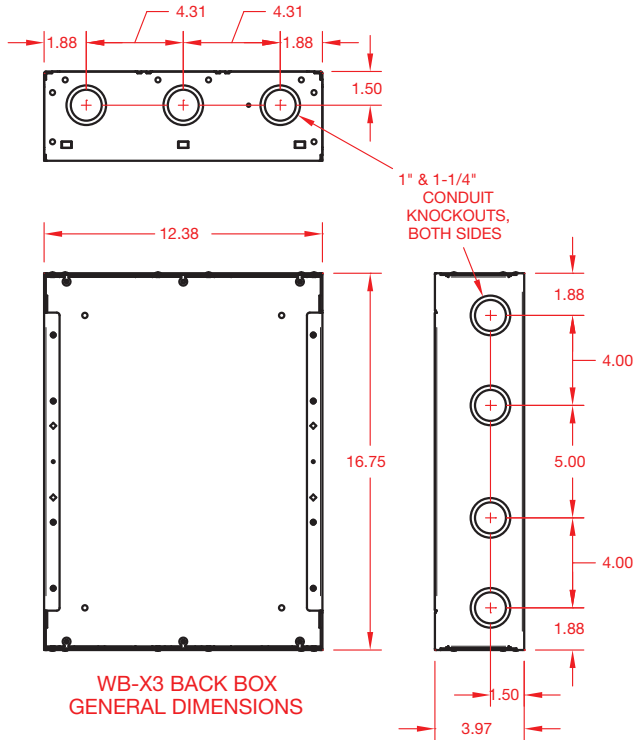

**WB-X3 BACK BOX
GENERAL DIMENSIONS**

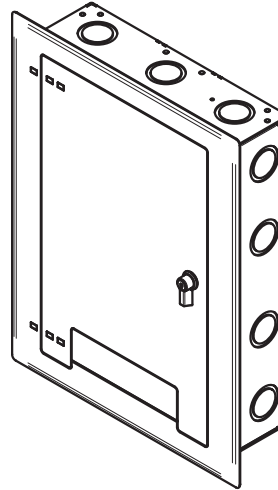

**WB-X3-CVR
FLUSH-MOUNTED COVER
(SHOWN WITH BACK BOX)**

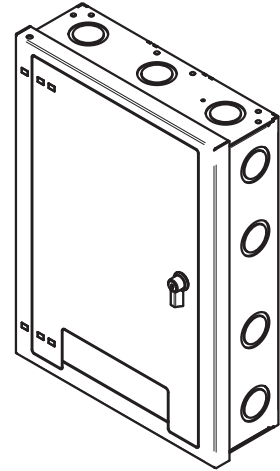

**WB-X3-SMCVR
SURFACE MOUNTED COVER
(SHOWN WITH BACK BOX)**

MODEL	FEATURES
WB-X3-GNG	BACK BOX, (3) 2 GANG AND (1) 4 GANG OPENINGS IN 2 ROWS w/KO's
WB-X3-IPS	BACK BOX, (36) IPS SLOTS, 3 ROWS OF 12 IPS SLOTS w/KO's
WB-X3-PLT	BACK BOX ONLY w/KO's
WB-X3-XLR	BACK BOX, (32) XLR HOLES, 4 ROWS OF 8 XLR HOLES w/KO's
WB-X3NK-GNG	BACK BOX, (3) 2 GANG AND (1) 4 GANG OPENINGS IN 2 ROWS w/o KO's
WB-X3NK-IPS	BACK BOX, (36) IPS SLOTS, 3 ROWS OF 12 IPS SLOTS w/o KO's
WB-X3NK-PLT	BACK BOX ONLY w/o KO's
WB-X3NK-XLR	BACK BOX, (32) XLR HOLES, 4 ROWS OF 8 XLR HOLES w/o KO's
WB-X3-CVR-BLK	LOCKING COVER, BLACK
WB-X3-CVR-WHT	LOCKING COVER, WHITE
WB-X3-SMCVR-BLK	LOCKING COVER, BLACK (SURFACE MOUNT)
WB-X3-SMCVR-WHT	LOCKING COVER, WHITE (SURFACE MOUNT)

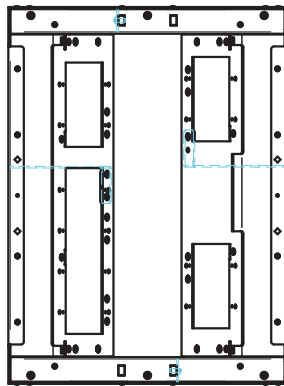

**WB-X3-GNG
BACK BOX**

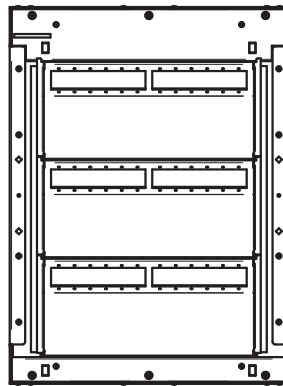

**WB-X3-IPS
BACK BOX**

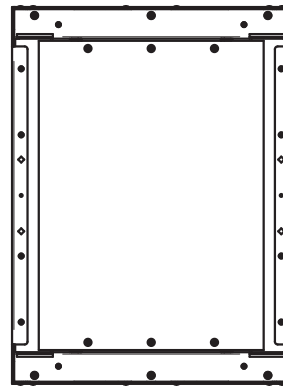

**WB-X3-PLT
BACK BOX**

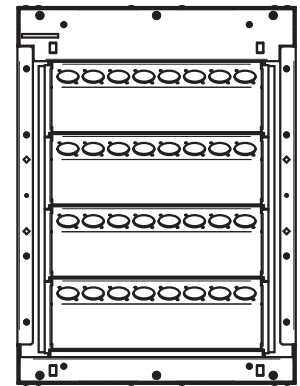

**WB-X3-XLR
BACK BOX**

Specifications are subject to change without notice.



244 Bergen Boulevard, West Paterson, NJ 07424
 Phone: 973.785.4347 · Fax: 973.785.4207
 Web: www.fsrinc.com · E-mail: sales@fsrinc.com