

JVC

8.2" Multi-format LCD Monitor

DT-V9L5

DT-F9L5

Compact and robust multi-format high-resolution LCD monitors for professional applications. Studio-use DT-V9L5 model and field-use DT-F9L5 model

DT-V9L5



HDMI™
HIGH-DEFINITION MULTIMEDIA INTERFACE

DT-F9L5



HDMI™
HIGH-DEFINITION MULTIMEDIA INTERFACE

* Monitor mounting arm, tripod and camcorder are not included

Features (DT-V9L5 and DT-F9L5)

- HD SDI input/output (1.5G) with embedded audio (16ch support)
- 16ch audio level indicator for embedded audio
- HDMI™ input × 1
- Mercury-free LED backlight
- IMD (In Monitor Display) function based on TSL's UMD protocol ver. 4.0
- Vector scope, waveform, histogram, and marker functions
- Remote function RS-232C in and MAKE/TRIGGER
- LTC, VITC, and D-VITC time code support
- Durable metal cabinet
- WXGA (1280 × 800) display
- Front-panel headphone jack

Features (DT-V9L5 only)

- AC/DC operation
- Tally lamp with separate/alternate mode
- Built-in speakers (1W mono)
- Desktop stand with tilt function

Features (DT-F9L5 only)

- Compact and lightweight with DC operation for field use
- Front tally lamp with separate/alternate mode
- Zebra, focus assist functions and rear tally lamp for location monitor usage

Specifications	DT-V9L5	DT-F9L5	
Display	Type	8.2" LCD Display	
	Drive system	ADS	
	Backlighting	LED (white LED)	
	Resolution	1280 (Horizontal) x 800 (Vertical) WXGA	
	Surface treatment	Glare	
	Panel brightness	360cd/m ²	450cd/m ²
	Contrast ratio	800:1	
	Aspect ratio	16:10	
	Viewing angle	160° (Horizontally) 160° (Vertically)	
	Display color	16.7million	
Latency	Less than 1 frame		
Response time	24 msec		
General	Weight	3.2kg (with stand), 2.3kg (without stand)	1.7Kg for Europe/Asia model 1.6Kg for US model
	Dimensions (WxHxD)	217mm x 176mm x 116mm (without stand) 8-5/8" x 7" x 4-5/8" (without stand) 217mm x 218mm x 185mm (with stand) 8-5/8" x 8-5/8" x 7-3/8" (with stand)	217mm x 176mm x 83.5mm 8-5/8" x 7" x 3-3/8"
	Power requirements	AC: 120V, 220V-240V 50/60Hz DC: 12V-17V	DC: 12V-17V
	Rated input current	0.5A (AC 120V), 0.25A (AC220V-240V), 1.3A (DC12V-17V)	1.3A (DC 12V-17V)
	Battery adaptor		IDX V-Mount for Europe/Asia model Anton Bauer QR Mount for US model
	Audio output	Internal speaker 1W (mono)	
Input terminals	VESA standard	100mm & 75mm M4x4	
	Composite (CVBS) IN	BNC x 1	
	Component IN	BNC x 3 (Y/Pb/Pr)	
	HDMI INPUT	HDMI connector x 1	
	HD/SD SDI INPUT	BNC x 2	
	AUDIO INPUT	RCA x 1 (mono)	
	Composite (CVBS) OUT	BNC x 1 with loop through	
	HD/SD SDI OUTPUT	BNC x 1 (Switched and rec-locked), (Embedded audio 16ch)	
	AUDIO OUTPUT	RCA x 2 (Monitor out)	
	Headphone OUT	Mini jack x 1 (Front)	
Output terminals	External control (Remote)	RS-232C: D-SUB 9pin x 1 RJ-45: 8pin x 1 (MAKE/TRIGGER)	
	Provided accessories	AC Power Cord, Power cord holder, Protect filter	Tripod Base (1/4-20UNC, 3/8 - 16UNC), Protect filter

Optional accessories: Rack mount adaptor for DT-V9L5 (RAK92LCD2), AC power adapter for DT-F9L5U (ADPV16)
Anton Bauer Battery Package for DT-F9L5U (AB-DIONIC-PKG)

Signal Name*1	Input Terminal			
	VIDEO	Analog COMPO.	E.AUDIO*2 HD/SD SDI	HDMI
NTSC NTSC 4.43	✓	—	—	—
PAL-M PAL60	✓	—	—	—
PAL PAL-N	✓	—	—	—
SECAM	✓	—	—	—
B/W50 B/W60	✓	—	—	—
480/60i	—	✓	—	✓
480/59.94i	—	✓	✓	✓
576/50i	—	✓	✓	✓
480/60p	—	✓	—	✓
480/59.94p	—	✓	—	✓
576/50p	—	✓	—	✓
640x480/60p	—	—	—	✓
640x480/59.94p	—	—	—	✓
720/60p	—	✓	—	✓
720/59.94p	—	✓	—	✓
720/50p	—	✓	—	✓
720/30p	—	—	—	—
720/29.97p	—	—	✓	—
720/25p	—	—	✓	—
720/24p	—	—	✓	—
720/23.98p	—	—	✓	—
1080/60i	—	✓	✓	✓
1080/59.94i	—	✓	✓	✓
1035/60i	—	—	✓	✓
1035/59.94i	—	—	✓	✓
1080/50i	—	✓	—	✓
1080/60p	—	✓	—	✓
1080/59.94p	—	✓	—	✓
1080/50p	—	✓	—	✓
1080/30p	—	—	—	✓
1080/29.97p	—	—	✓	✓
1080/25p	—	—	✓	✓
1080/24p	—	—	✓	✓
1080/23.98p	—	—	✓	✓
1080/30PsF	—	—	✓ ³	—
1080/29.97PsF	—	—	✓ ¹⁴	—
1080/25PsF	—	—	✓ ¹⁵	—
1080/24PsF	—	—	✓	—
1080/23.98PsF	—	—	✓	—

✓ : Compatible — : Not compatible

*1 For signal format other than E.AUDIO HD/SD SDI input "-/59.94", "-/29.97", and "-/23.98" will be displayed as "-/60", "-/30" and "-/24" respectively.

*2 Compatible with EMBEDDED AUDIO signals.

*3 The signal is recognised as 1080/60i, and the status is displayed as "1080/60i"

*4 The signal is recognised as 1080/59.94i, and the status is displayed as "1080/59.94i"

*5 The signal is recognised as 1080/50i, and the status is displayed as "1080/50i"

Terminals

DT-V9L5

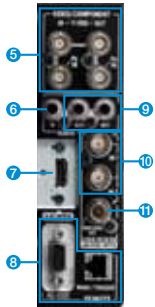

- Power switch
- AC IN
- DC switch
- DC IN
- VIDEO/COMPONENT terminal (BNC)
- AUDIO IN
- HDMI INPUT
- REMOTE terminal
- AUDIO OUT
- E.AUDIO HD/SD SDI (IN 1, IN 2) terminal (BNC)
- E.AUDIO HD/SD SDI (SWITCHED OUT) terminal (BNC)

DT-F9L5

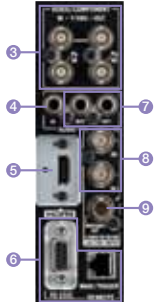

- Power switch
- DC IN
- VIDEO/COMPONENT terminal (BNC)
- AUDIO IN
- HDMI INPUT
- REMOTE terminal
- AUDIO OUT
- E.AUDIO HD/SD SDI (IN 1, IN 2) terminal (BNC)
- E.AUDIO HD/SD SDI (SWITCHED OUT) terminal (BNC)

External Dimensions

Unit: mm (inches)

DT-V9L5

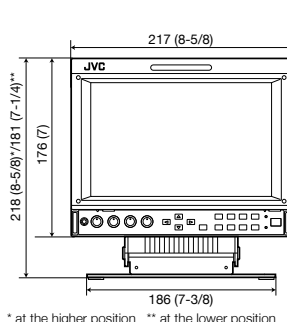

* at the higher position ** at the lower position

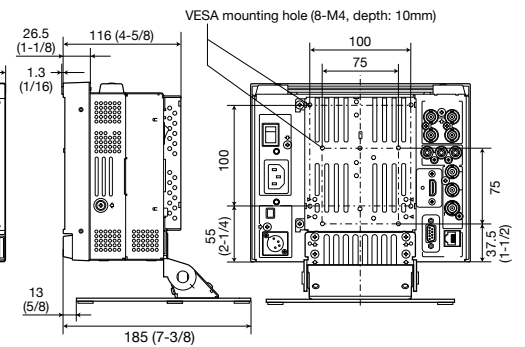

DT-F9L5

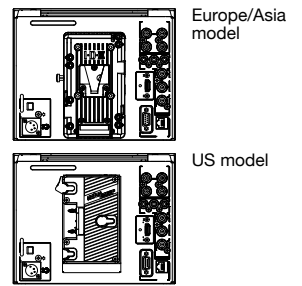
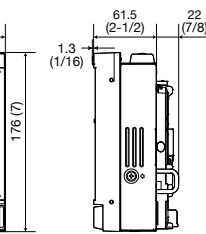
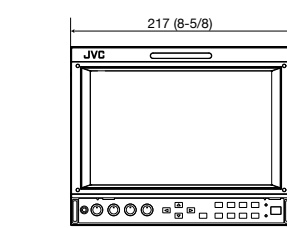

Europe/Asia model

US model

HDMI, the HDMI logo and High-Definition Multimedia Interface are trademarks or registered trademarks of HDMI Licensing LLC. All other brand or product names may be trademarks and/or registered trademarks of their respective owners. Any rights not expressly granted herein are reserved. All information in this document is subject to change without notice. Copyright © 2013, JVCENWOOD Corporation. All Rights Reserved.

Simulated pictures.
The values for weight and dimensions are approximate.
E.&O.E. Design and specifications subject to change without notice.

JVC

DISTRIBUTED BY