

## VBH-1BB/RR 75 Ω composite video isolator

- Eliminates hum bars caused by ground loops
- Exceptional performance, will not deteriorate picture quality
- Very high ground isolation: 120 dB CMMR typ at 60 Hz
- Precise impedance matching ensures minimal reflection



The Iso•Max VBH-1BB is a one channel 75 Ω video isolator for component video that is used to prevent 60 cycle 'hum bars' even where ground voltage differences can be very large such as in ceiling mounted projectors in house of worship, conferences centers and night clubs.

Designed for use with standard RG59 type coaxial cable, the VBH-1BB combines true 75 Ω BNC or RCA connectors with a unique humbucking circuit to deliver an exceptionally linear bandwidth with virtually zero insertion loss, contamination or artifact. One simply connects the passive device in series and problems such as ground loops are eliminated, reducing noise by as much as 56 dB at 60 Hz.

The VBH-1BB is a tremendous time saver as it eliminates excessive troubleshooting when hunting down sporadic problems. Once installed, it often eliminates future service calls that can be attributed to non-related voltage fluctuations caused by cycling refrigeration systems, power transformers or nearby industrial facilities that may be causing power disruptions.

## Applications

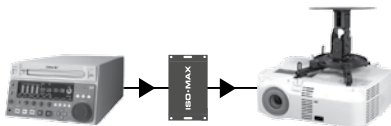

### VBH-1BB/RR with a projector

Often the projector is mounted in the ceiling, where separate circuits supply the projector and the source video player. Isolating the transmission line with the VBH-1BB/RR helps eliminate hum bars and improves the picture quality.

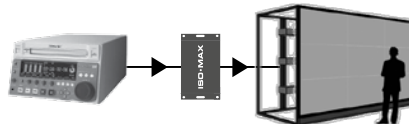

### VBH-1BB/RR in a live show

Today, live shows often combine video backdrops and screen projections to the action on stage. The challenge is keeping the video feed clean when the various equipment that surrounds it may be 'polluted' by motors, dimmers, and power transformers. Isolating the video system with the VBH-1BB/RR solves the problem.

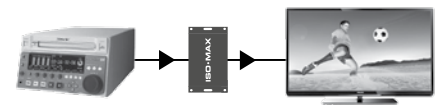

### VBH-1BB/RR with composite video

There are still many installed systems that employ composite video to distribute the signal. In these installations, hum bars can often appear when certain equipment is activated such as refrigeration systems, air conditioning, motors, or dimmers. One merely inserts the VBH-1BB/RR into the signal path to prevent signal degradation.

## Dimensions

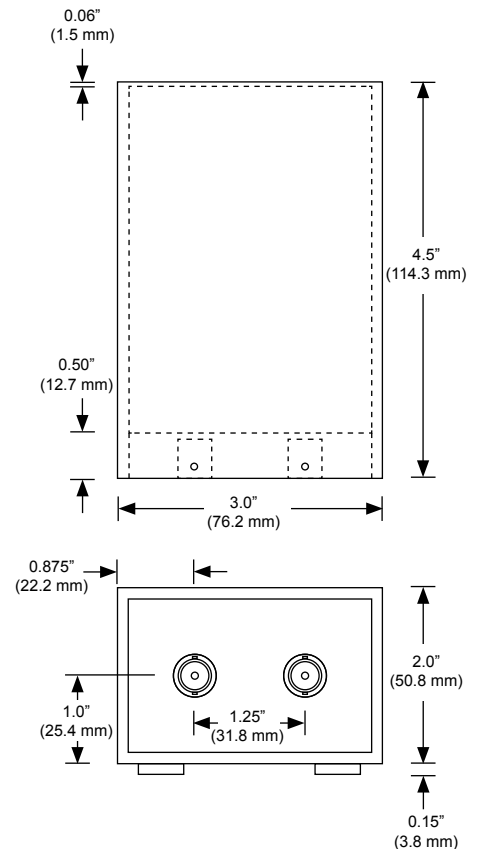

## Connector options

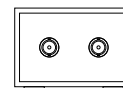

**VBH-1BB**  
Connectors: BNC  
Bandwidth: DC to 900 Mhz

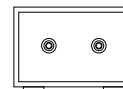

**VBH-1RR**  
Connectors: RCA  
Bandwidth: DC to 600 Mhz

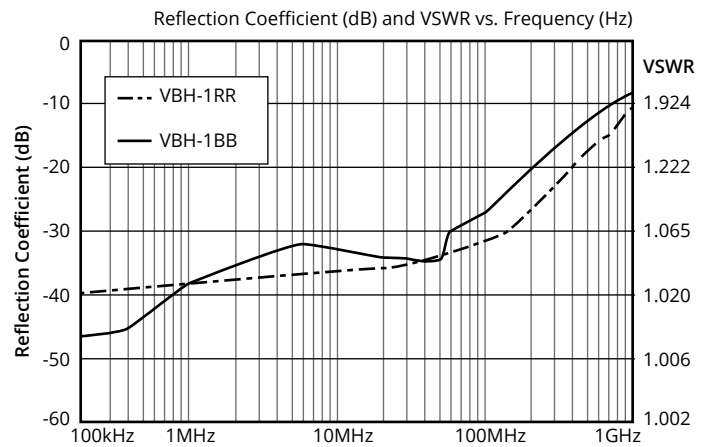
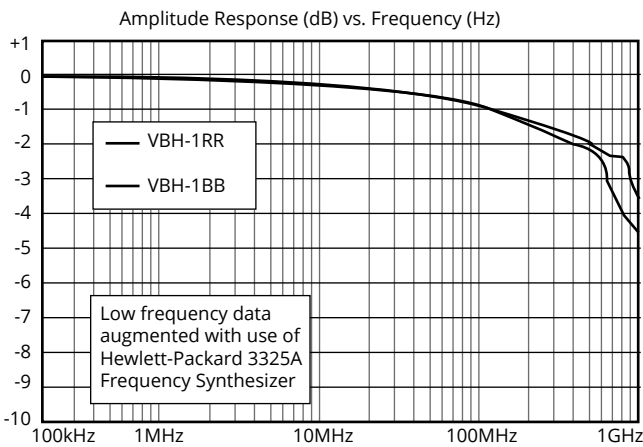
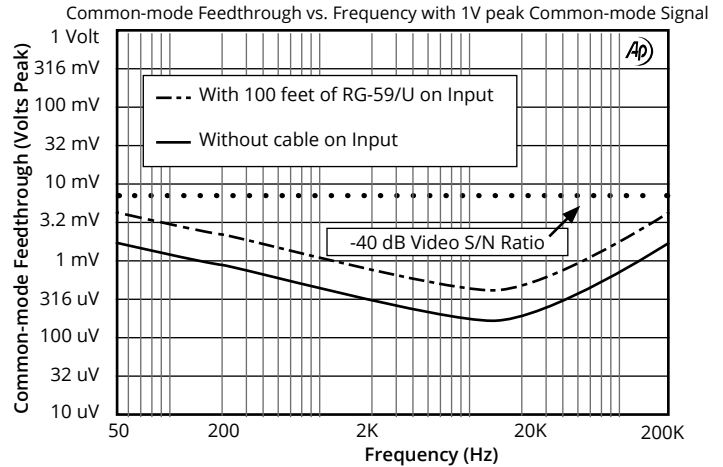
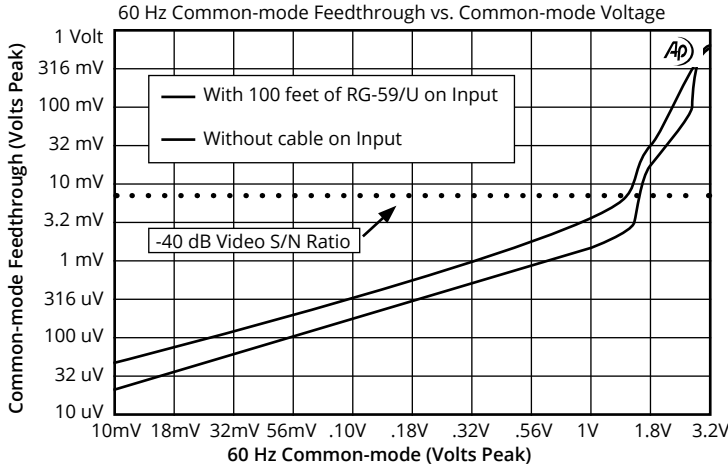

PARAMETER	CONDITIONS	MINIMUM	TYPICAL	MAXIMUM
Input impedance, Z <sub>i</sub>	10 kHz, test circuit 1		75 Ω	
Insertion loss	10 kHz, test circuit 1 (referred to -6.02 dB)		-0.05 dB	-0.10 dB
High Frequency Response, ref 10 kHz	100 kHz, test circuit 1 (referred to -6.02 dB)		-0.005 dB	
High Frequency Response, ref 10 kHz	1 MHz, test circuit 1 (referred to -6.02 dB)		-0.005 dB	
High Frequency Response, ref 10 kHz	3.58 MHz, test circuit 1 (referred to -6.02 dB)		-0.10 dB	
High Frequency Response, ref 10 kHz	10 MHz, test circuit 1 (referred to -6.02 dB)		-0.20 dB	
High Frequency Response, ref 10 kHz	100 MHz, test circuit 1 (referred to -6.02 dB)	-1.00 dB	-0.80 dB	
Low Frequency Response Ratio	test circuit 1		DC	
Common - mode rejection ratio	60 Hz, test circuit 2, no cable	50 dB	56 dB	
Common - mode rejection ratio	60 Hz, test circuit 2, with 100 feet (30.5 m) of RG-59/U cable at input		48 dB	
Maximum common-mode voltage	60 Hz, test circuit 3, 3% THD	1.4 V <sub>peak</sub>	1.7 V <sub>peak</sub>	
Inductance	60 Hz, 500mVrms, shield, input to output		200 mH	
DC resistances	center conductor, input to output		0.70 Ω	
DC resistances	shield, input to output		0.20 Ω	
Capacitances	center conductor to shield		200 pF	
Time Delay Skew between channels			0.1 nS	0.5nS
Weight			4 lbs. (0.45 kg)	
Temperature range	operation or storage	0°C		70°C

(source Z - load Z - 75 Ohms, signal level = 1Vpp unless otherwise noted, specifications apply to all 3 independent channels)

IMPORTANT NOTE: THIS PRODUCT IS NOT INTENDED FOR USE IN CIRCUMSTANCES WHERE THE DC OR PEAK AC VOLTAGE BETWEEN INPUT AND OUTPUT CONNECTIONS EXCEEDS 34 VOLTS OR WHERE ITS FAILURE COULD CAUSE INJURY OR DEATH.

Test Circuit 1:

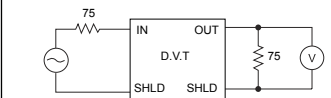

Test Circuit 2:

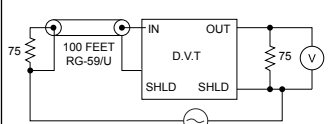

Test Circuit 3:

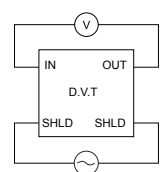

All minimum and maximum specifications are guaranteed. Unless noted otherwise, all specifications apply at 25°C. Specifications subject to change without notice. All information herein is believed to be accurate and reliable, however no responsibility is assumed for its use nor for any infringements of patents which may result from its use. No license is granted by implication or otherwise under any patent or patent rights of Jensen Transformers, Inc.