

SKELETOOL® CX    154CM

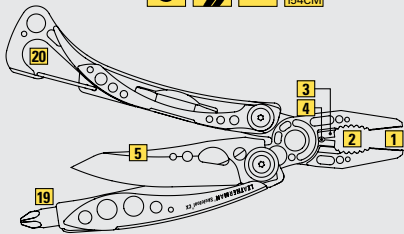

SKELETOOL®    420HC

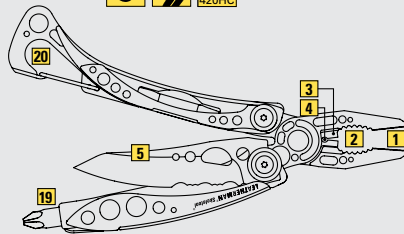

FREESTYLE®    420HC

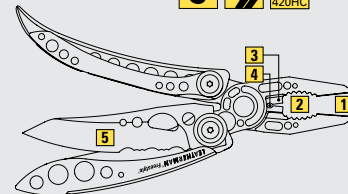

JUICE® XE6    420HC

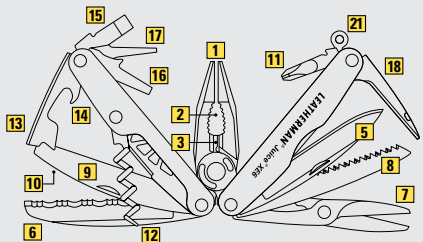

JUICE® CS4    420HC

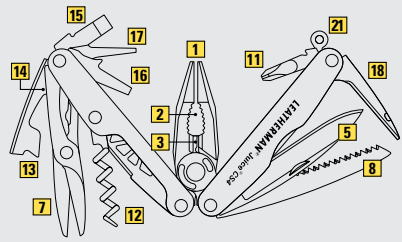



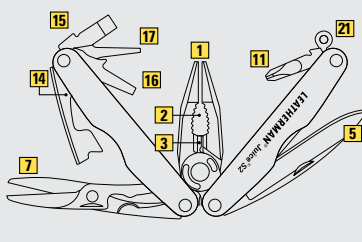



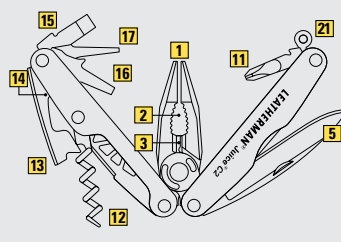

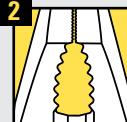

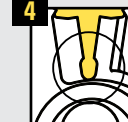
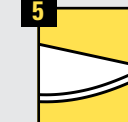

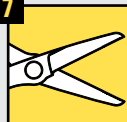
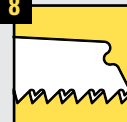

JUICE® S2    420HC

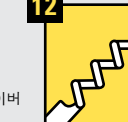

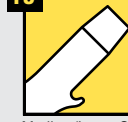
JUICE® C2    420HC

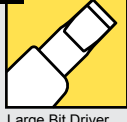
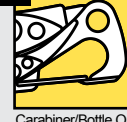
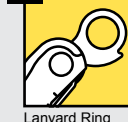

<p>1 </p> <p>Nebbetang Punttang Острогубцы 니플노즈 플라이어 ラジオペンチ 尖嘴鉗</p> <p>Needlenose Pliers Pincas à bec effilé Spitzzange Pinzas de punta Pinza a becchi piatti</p>	<p>2 </p> <p>Pinza regolare Vanlig tang Nijptang Обычные плоскогубцы 잠금 플라이어 標準型ペンチ 普通鉗</p> <p>Regular Pliers Pincas régulières Normale Zange Alicates de punta delgada</p>	<p>3 </p> <p>Avbitertang (hardwire) Draad/ijszerdraad-kniptang Кусачки для проволоки / жесткого провода 와이어/하드 와이어 커터 ワイヤー/ハードワイヤーカッター 剪线钳/硬线钳</p> <p>Wire Cutters Cisailles / Coupe fils (Hart-)Drahtschneider Cortadores de alambre y de alambre duro Pinza tagliafili/tagliacavi</p>	<p>4 </p> <p>gliacavi Avbitertang (hardwire) Draad/ijszerdraad-kniptang Кусачки для проволоки / жесткого провода 와이어/하드 와이어 커터 ワイヤー/ハードワイヤーカッター 剪线钳/硬线钳</p> <p>Hard-wire Cutters Cisailles / Coupe fils (Hart-)Drahtschneider Cortadores de alambre y de alambre duro Pinza tagliafili/ta-</p>	<p>5 </p> <p>Kniv Mes Hож ナイフ ナイフ 刀 刀</p> <p>Knife Couteau Messer Hoja Coltello</p>	<p>6 </p> <p>Gekarted mes Hож зубчатости 톱니 모양을 가진 칼 波刃ナイフ 鋸齒刀 鋸齒刀</p> <p>Serrated Knife Couteau cranté Wellenschliffmesser Hoja de fijo serrada Coltello seghettato Griepflater kniv</p>
<p>7 </p> <p>Saks Schaar Ножницы 가위 ハサミ 剪刀</p> <p>Scissors Ciseaux Schere Tijeras Forbici</p>	<p>8 </p> <p>Sag Zaag Пила 톱 のこぎり 鋸</p> <p>Saw Scie Säge Sierra Sega</p>	<p>9 </p> <p>Lima diamante Diamantbelagt fil Diamantvijl Напильник с алмазным покрытием 다이아몬드 코팅 줄 ダイヤモンドコーティングヤスリ 金剛石鍍層銼 金剛石鍍層銼</p> <p>Diamond-coated File Lime diamantée Diamantbeschichtete Feile Lima de diamante</p>	<p>10 </p> <p>Lima per legno/ metallo Tre-/metalfil Hout/metaalvijl Напильник по дереву / металлу 목재/ 금속 줄 木/金屬用ヤスリ 木/金屬銼</p> <p>Wood/Metal File Lime à bois/métal Holz-/Metalfeile Lima de madera/ metal</p>	<p>11 </p> <p>Cacciavite Phillips Stjerneskrutrekker Kruiskopschroevendraaier Напильник по дереву / металлу 필립스 스크루드라이버 プラスドライバー 十字螺丝刀</p> <p>Phillips Screwdriver Tournevis cruciforme Kreuzschlitzschraubendreher Destornillador Phillips</p>	<p>12 </p> <p>Korktrekker Kurkentrekker Шронор 코르크 병따개 コルク抜き 开塞钻 開塞鑽</p> <p>Corkscrew Tire-bouchon Korkenzieher Sacacorchos Cavatappi</p>
<p>13 </p> <p>Cavatappi con supporto Korktrekker med assistanse Kurkentrekker met steun Шронор со вспомогательным механизмом 보조장치가 있는 코르크 병따개 アシスト付きコルク抜き 带助力开塞钻 带助力開塞鑽</p> <p>Corkscrew Assist Tire-bouchon avec levier Korkenzieher mit Hebel Sacacorchos con accesorio</p>	<p>14 </p> <p>Flaskeåpner Flessenopener Открывалка для бутылок 병따개 栓抜き 開瓶器</p> <p>Bottle Opener Ouvre-bouteilles Kapselheber Abrebotellas Apribottiglie</p>	<p>15 </p> <p>Destornillador mediano/grande cacciavite medio/grande Melleinstor/stor skrutetrækker Medium/Stor Skrutrekker Средняя/ Большая отвертка 중/대 스크루드라이버 中/大型スクルードライバー 中号/大号螺丝刀 中号/大号螺丝刀</p> <p>Medium/Large Screwdriver Tournevis de moyenne/ grande taille Mittlerer/großer Schraubendreher</p>	<p>16 </p> <p>Cacciavite piccolo Liten skrutrekker Klein schroevendraaier Малая отвертка 소형 스크루드라이버 カーボンファイバー 小號螺丝刀 小號螺丝刀</p> <p>Small Screwdriver Tournevis petit Kleiner Schraubendreher Destornillador pequeño</p>	<p>17 </p> <p>pequeño cacciavite mini Ekstra lille skrutetrækker Ekstra liten Skrutrekker Маленькая отвертка 특소형 스크루드라이버 特小スクルードライバー 超小螺丝刀 超小螺丝刀</p> <p>Extra-small Screwdriver Tournevis de très petite taille Extraleiner Schraubendreher Destornillador extra-</p>	<p>18 </p> <p>Syl Priem Шило с ушком 송곳 키리 尖锥 尖锥</p> <p>Awl Poinçon Ahle Punzón Punteruolo</p>
<p>19 </p> <p>Portapunta grande Stor bitstrekker Grote bit houder Держатель для больших бит 넓은 드라이버 大型ビットドライバー 大号可换头螺丝刀 大號可換頭螺絲刀</p> <p>Large Bit Driver Adaptateur pour grand embout Großer Bithalter Soporte grande para puntas</p>	<p>20 </p> <p>botellas Moschettone/apribottiglie Karabinkrok/ flaskeåpner Carabijnhaak/Flessenopener Карабин / открывалка для бутылок 카라비너/병따개 カラビナ/栓抜き 登山勾/开瓶器 登山鉤/開瓶器</p> <p>Carabiner/Bottle Opener Mousqueton / Ouvrebouteilles Kapselheber Abrebotellas Apribottiglie</p>	<p>21 </p> <p>Festering Koordoog Кольцо для ремня 다용도 고리 ランヤードリング 收緊索環 收緊索環</p> <p>Lanyard Ring Anneau portedragonne Anhängöse Anillo de sujeción Anello a rilascio rapido</p>			

<p></p> <p>Dispositivo di blocco completo delle lame Heltlåsede blader Vergrendelmessen Лезвия с полной блокировкой 모든 잠금 칼날 ロックングブレード 全鎖刀片 全鎖刀片</p> <p>All-locking Features Lames entièrement verrouillables Arretierung für alle Werkzeuge Hojas de bloqueo de seguridad</p>	<p></p> <p>una sola mano Lame a sgancio rapido Enhåndspåning av blader Met een hand te openen messen Лезвия, открываемые одной рукой 한손 오픈 칼날 ワンハンドオープンブレード 可单手打开的刀 可单手打開的刀</p> <p>One-hand Opening Blades Lames ouvrables d'une seule main Einhandöffnung Hojas de apertura con</p>	<p></p> <p>cesible Lama a scatto esterna Blader tilgjengelig utvendig Buitenaf benaderbaar mes Лезвия с наружным открыванием 외부에서 이용할 수 있는 칼날 外部アクセシブルレード 可外开的刀 可外開的刀</p> <p>Outside-accessible Blades Lame accessible de l'extérieur Außen liegende Werkzeuge Hojas externa ac-</p>	<p></p> <p>Scale graduate di alluminio Aluminiumbelegg Aluminium grip Алюминиевые накладки 알루미늄 표면 알루미늄 우물 ケール 鉛握把 鉛握把</p> <p>Aluminum Scales Plaques des manches en aluminium Griffschalen aus Aluminium Cachas de aluminio</p>	<p></p> <p>Karbonfiber Koolstofvezel Углеволокно 탄소 섬유 カーボンファイバー 碳纤维 碳纤维</p> <p>Carbon-fiber Fibre de carbone Carbonfaser Fibra de carbono</p>	<p></p> <p>420HC 420HC acciaio inossidabile 420HC Rustfritt stål 420HC roestvrij staal Нержавеющая сталь 420HC 420HC 스테인레스 스틸 420HC 스텐레스 420HC不銹鋼 420HC不銹鋼</p> <p>420HC Stainless Steel Acier inoxydable 420HC 420HC Edelstahl De acero inoxidable</p>	<p></p> <p>De acero inoxidable 145CM 154CM acciaio inossidabile 154CM Rustfritt stål 154CM roestvrij staal Нержавеющая сталь 154CM 154CM 스테인레스 스틸 154CM 스텐레스 154CM不銹鋼 154CM不銹鋼</p> <p>154CM Stainless Steel Acier inoxydable 154CM 154CM Edelstahl</p>
--	---	---	---	---	---	--

POCKET-SIZE TOOL USER GUIDE

© 2011 LEATHERMAN TOOL GROUP, INC. 939764 1011

Caution: This product contains one or more sharp blades or pinch points. Warranty: Limited liability 25-year warranty. See leatherman.com for more information.

Attention : ce produit contient une ou plusieurs lames aiguisées ou points de pincement. Garantie : garantie limitée de 25 ans. Pour en savoir plus, visitez le site leatherman.com.

Achtung: Dieses Produkt weist eine oder mehrere scharfe Klingen auf. Vorsicht vor Quetschungen

beim Öffnen und Schließen. Garantie: 25 Jahren Garantie mit beschränkter Haftung. Weitere Informationen auf leatherman.com.

Precaución: Este producto contiene una o varias cuchillas afiladas o piezas punzantes. Garantía: Período de garantía de 25 años de responsabilidad limitada. Consulte leatherman.com para obtener más información.

Attenzione: il prodotto contiene lame affilate e strumenti che comportano rischio di schiacciamento. Garanzia: garanzia di 25 anni a responsabilità

limitata. Per ulteriori informazioni, consultare il sito web leatherman.com.

Advarsel: Dette produktet inneholder et eller flere skarpe blader eller klempunkter. Garanti: Begrenset 25-års garanti. Se leatherman.com for mer informasjon.

Let op: dit product bevat een of meer scherpe messen of punten. Garantie: 25 jaar beperkte garantie. Ga naar leatherman.com voor meer informatie.

предупреждение: данное изделие имеет одно или несколько острых лезвий или колющих наконечников. Гарантия: ограниченная гарантия в течение 25 лет. Более подробная информация представлена на сайте leatherman.com.

주의: 이 제품은 하나 이상의 다용도 칼날과 공구들이 포함되어 있습니다. 보증: 25년간 품질 보증. 자세한 내용은 leatherman.com을 참조하십시오.

注意: この製品には、鋭い刃先やパーツで怪我をしない様に注意。保証: 25年間の保証が付いています。詳しくは、ウェブサイト leatherman.com をご覧ください。

注意: 此产品包含一个或多个锋利刀片或者夹伤点。保修: 25 年有限担保。浏览 leatherman.com 获取更多信息。

注意: 此產品包含一個或多個鋒利刀片或者夾傷點。保固: 25 年有限擔保。流覽 leatherman.com 獲取更多資訊。

USING THE WIRE CUTTERS

UTILISATION DES PINCES COUPE FILS
 VERWENDEN DES DRAHTSCHNEIDERS
 USO DE CORTADORES DE ALAMBRE
 UTILIZZO DELLA PINZA TAGLIAFILFI
 BRUKE AVBITERTENGER
 GEBRUIK VAN DE DRAADKNIPTANGEN
 ИСПОЛЬЗОВАНИЕ КУСАЧЕК ДЛЯ ПРОВОЛОКИ

와이어 커터 사용
 ワイヤークッターの使用方法
 使用切线钳
 使用切線鉗

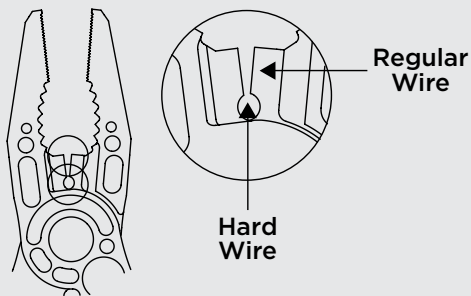

OPENING THE BLADES
 OUVERTURE DES LAMES
 ÖFFNEN DER WERKZEUGE
 APERTURA DE LAS HOJAS
 APERTURA DELLE LAME
 ÅPNE BLADER
 MESSEN OPENEN
 ОТКРЫВАНИЕ ЛЕЗВИЙ

칼날 오픈
 ブレードの開閉
 打开刀片
 打開刀

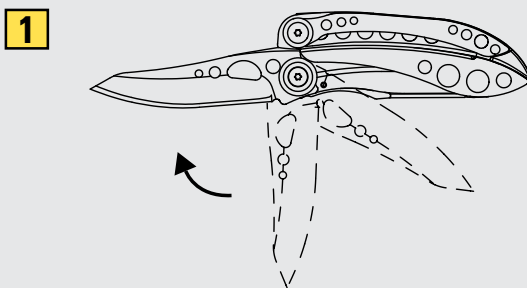

USING THE CORKSCREW
 UTILISATION DES TIRE-BOUCHON
 VERWENDEN KORKENZIEHER
 USO DE SACACORCHOS
 UTILIZZO DELLA CAVATAPPI
 BRUKE KORKETREKKER
 GEBRUIK VAN DE KURKENTREKKER
 ИСПОЛЬЗОВАНИЕ ДЛЯ ШТОПОР

코르크 병따개 사용
 を使用して コルク抜き
 使用开塞钻
 使用開塞鑽

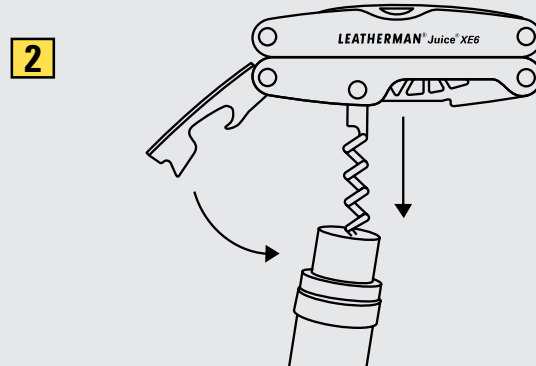
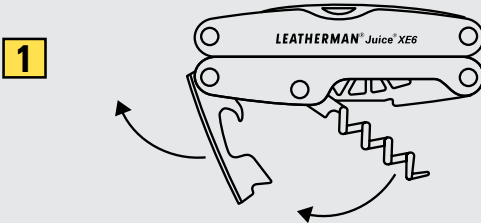

Check us out on Facebook (www.facebook.com/leathermanusa) for giveaways, tool tales and multi-faceted conversation!



Check us out on You Tube (www.youtube.com/leathermanmedia) for great product demos



WWW.LEATHERMAN.COM
 Leatherman Tool Group, Inc. P.O. Box 20595, Portland, Oregon 97294