

General Warnings

The Lowel DP Light is a professional lighting fixture. Read these instructions and lamp manufacturer's warnings before operating.

- **Not for house hold use**, use only for film, video or imaging purposes.
- **Do not leave fixture unattended**
- **Make certain that lamp voltage matches power source voltage.** The units use lamps of different voltages. Example: never connect a 120 volt lamp to a 220 volt source.
- **Units such as these emit considerable light and heat**, and if not properly used, could be dangerous.
- **Open faced lights should not be** positioned extremely close to people. Ultraviolet light ray emissions can cause damage to the eyes and reddening of the skin. The likelihood of either occurring is increased with length of exposure, focus intensity and proximity. Therefore, lights should be kept away from people or a dichroic, frosted glass, clear glass or UV gel filter should be used. Bounce illumination also reduces this problem.
- **When using fixture with umbrella** accessory, do not focus to spot or half-spot. Scorching / damage to umbrella could occur.
- **The protective screen must be used** to protect people and property in the unlikely event of a defective lamp exploding.
- **Avoid aiming the light at** or placing close to people, delicate objects or flammable materials.
- **Do not interfere with ventilation** by covering the lights in any way.
- **Unplug fixture when unattended** or when relamping.
- **Never touch hot parts.**
- **Do not use near standing water.**
- **Avoid mounting lights directly** over people unless secured with a safety cord or cable.
- **Lights should not be operated while** tipped on side.

Yes

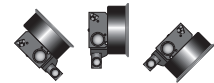

No



■ **DP Lights** are supplied with a Protective screen that will help protect people and property in the unlikely event of a defective lamp exploding which may scatter particles of extremely hot glass and filament about a distance of several feet causing possible injury, damage or fire.

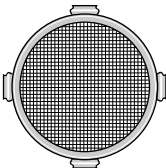

Warning: Never operate light without protective screen installed.

DP Light

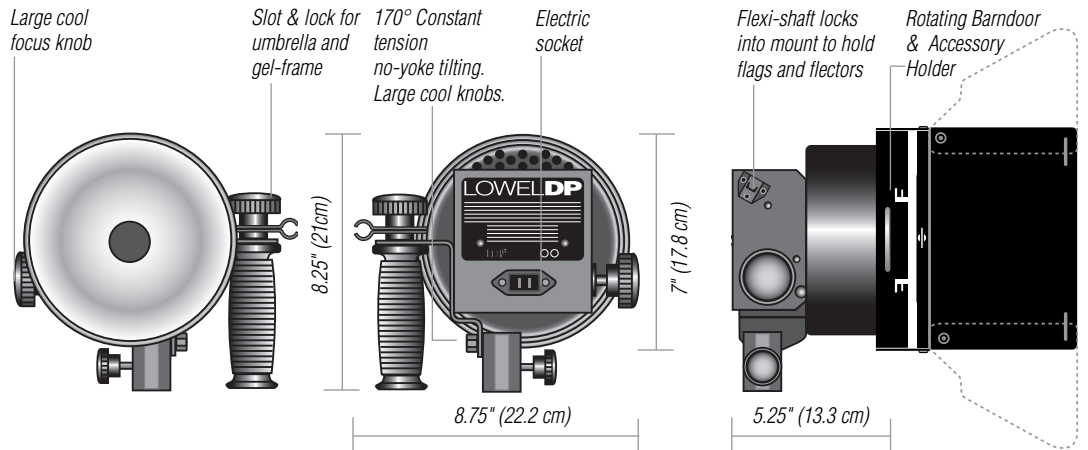

Weight with 16' cable: 3.6 lbs (1.6 kg)
Weight less 16' cable: 2.8 lbs (1.3 kg)
Max. wattage: 1000
Max. amperage: 8.3 at 120v
Beam control: continuously variable

Fits on: 5/8" (1.59 cm) studs
Materials: primarily aluminum alloy
Cable: 16' (4.88 m) #16/3
Switch: in-line, heavy-duty
U.S. Patent: D 210972

Technical Data



Lamp/Beam Data

Lamp Code	Volts	Watts	°K	Avg Life	Foot Candles (lux) at 10' (3 m), w/prot. screen			Super Spot
					Flood	Spot	Focus Range	
EHC	120	500	3200	300hr	43 (465)	390 (4200)	9:1	678 (7300)
EHD	120	500	3000	2000hr	35 (375)	339 (3650)	10:1	743 (8000)
EHF	120	750	3200	300hr	73 (780)	554 (5960)	8:1	892 (9600)
EHG	120	750	3000	2000hr	70 (750)	390 (4200)	6:1	827 (8900)
FEL	120	1000	3200	300hr	88 (950)	711 (7650)	8:1	1161 (12500)
JCV220V-								
500WBM	220	500	3000	2000hr	43 (465)	242 (2600)	6:1	505 (5450)
FEP/220	220	1000	3200	150hr	74 (795)	604 (6500)	8:1	1133 (12200)
JCV240V-								
500WBM	240	500	3000	2000hr	45 (490)	218 (2350)	5:1	449 (4850)
FKR/230	230	650	3100	300hr	61 (660)	381 (4100)	6:1	734 (7900)
FEP/240	240	1000	3200	150hr	77 (825)	627 (6750)	8:1	1074 (11560)

Performance

With 120v, 1000w, 3200°K, FEL lamp

Foot Candles (Lux = foot candles x 10.8)					
Flood	297	88	40	23	16
Spot	3066	711	307	166	109
Super Spot with high intensity reflector	5667	1161	604	334	209

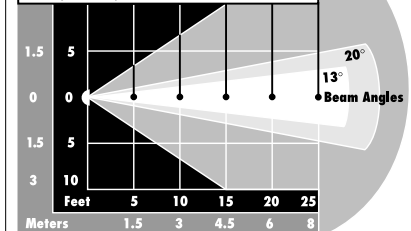

To Store DP

When fixture is cool to the touch. Disconnect plug on rear of light, swing in extending flaps on large doors and "square" barn-door with unit. It is not necessary to remove barndoor or flaps.

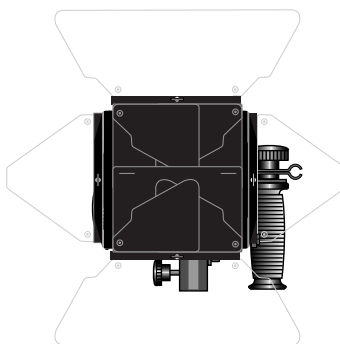

DP Lamps Replacement

Warning: Always unplug unit before relamping.
 Lamps must be operated at their rated voltage. Avoid touching "glass" with bare fingers. Insert lamp carefully, to avoid breaking. Due to inconsistencies in lamp (bulb) production, an individual lamp may function for less than average rated life. Some lamp manufacturer's are of better quality than others and may provide longer life and better performance.

Lamps may be changed with reflectors installed or removed.

Set focus knob in flood position; rock lamp gently from side to side while lifting from socket. The electrical contacts of the DP lamp socket are very "stiff" and require considerable lamp insertion pressure to properly seat the lamp. If the lamp is not fully inserted,

it can cause arcing and pitting of both the socket and lamp pins reducing both lamp and socket life. We suggest that you do not remove the lamp from the fixture when transporting the light, locally.

DP Adjustment

The DP Light constant-tension (torque) tilt can be adjusted with the bolt located on the stand fitting using a 3/8" wrench.

Do not over tighten!

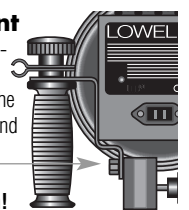

Lowel DP Light Instructions

Light Controls

Reflectors

The DP light has a standard, general purpose reflector and two special purpose reflectors. Reflectors are embossed for identification



#1 Reflector

Code: D2-15

Standard, full focusing reflector with Lowel's peened, parabolic, non-crossover configuration.



#3 Reflector

Code: D2-17

Super-spot, fixed-focus, reflector has a narrow, high intensity beam for extremely long throws.

Changing DP Reflectors

When fixture is cool to the touch. Disconnect plug on rear of light. Remove protective screen then remove reflector retaining spring by first pulling either end of spring inward Tilt fixture down slightly until reflector falls forward. Tilt fixture up and install new reflector, replace reflector ring and protective screen.

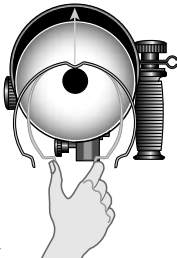

Warning: Never operate light without protective screen installed.

Complete DP Barndoor

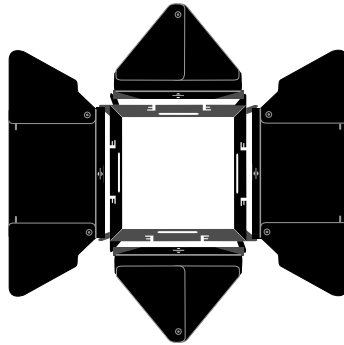

Code: D2-20

Barndoor Frame with two rectangular and two triangular leaves, all expandable. Rotates 360° and holds 2 accessories (dichroic, snoot, etc.).

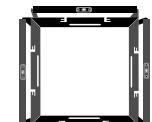

Barndoor frame

Code: D2-21

Snaps onto rim on front of light. It can be removed by pushing out on two adjacent sides while pulling that corner forward. If barndoor frame fails to maintain proper tension on light, the frame should be removed and squeezed inward, very slightly.

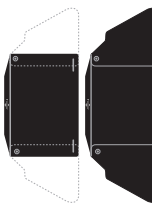
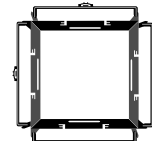

Rectangular Leaf

Code: D2-22

Has two extending wings which stop in open position, this stop may be bypassed. The Locking Fastener requires 1/4 turn to remove or install doors



The Triangular Leaf

Code: D2-23

Has two extending wings to increase their area or create special shadowing effects. The Locking Fastener requires 1/4 turn to remove or install doors.

DP Barndoor Accessories

Each barndoor frame can hold any two barndoor accessories. Bottom handles on the accessories are sprung together to insert or remove accessory. First accessory used should be positioned in rear slots. Second accessory or snoot can then be used in forward slots.

When a wire scrim and glass accessory are used simultaneously, the wire scrim should be placed closest to the lamp, to reduce the possibility of glass breakage.

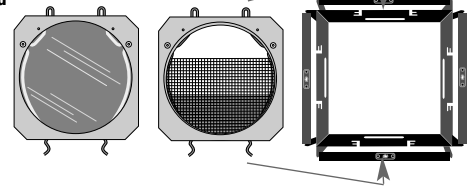

Accessory Front Glass Instructions & Warnings

These Glass Accessories:

- act as safety shields in the event of a violent lamp failure
- reduce the harmful effects of UV rays
- are made of Pyrex® and will break if dropped or mishandled, care should be taken to avoid chipping and deep scratching of the glass as this will weaken it
- should be allowed to cool before being stored or shipped
- should be wrapped for protection when stored or shipped
- should be used in the forward barn door frame position (further from the lamp), if a second accessory (such as a scrim) is used, place that accessory in the rear position of the frame (closer to the lamp)
- require care when cleaning the surface of the dichroic filter to avoid damaging the coated surface

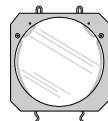

Dichroic Filter

Code: D2-51

Converts 3200 K lamps to average daylight; absorbs some U.V. light rays. Light loss approximately 50%.

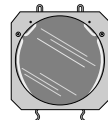

Clear Glass

Code: D2-52

Absorbs some U.V. light rays. Light loss approximately 5%.

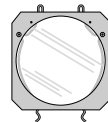

Diffused Glass

Code: D2-50

Softens highlights and shadows. Absorbs some U.V. light rays. Light loss approximately 40%.

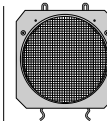

Full Scrim

Code: D2-54

Reduces light intensity by approximately 50%.

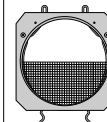

Half Scrim

Code: D2-55

Covers half of reflector and rotates 360° darkens washed out foregrounds, compensates for actors "burning up" as they approach a light.

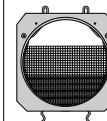

Graduated Scrim

Code: D2-56

Same principle as half scrim but effect is more gradual and more extreme.

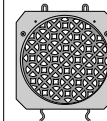

Cookaloris

Code: D2-57

Produces an overall, soft shadow pattern, can be used to "breakup" a plain background.

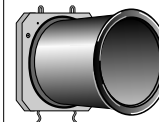

Snoot

Code: D2-53

Produces a reduced circle of light; Two Snoots may be joined with an additional barndoor frame to produce a smaller and sharper circle of light. Barndoors and barndoor accessories may also be added to the end of the Snoot.

DP Narrow Snoot

Code: D2-532

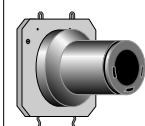

With smaller diameter circular cutoff (2.25" diameter), accepts Fren-L patterns as well as Pro-light barndoors & swing-in accessories.

Problems, info, repairs, etc.

Lowel equipment and kits are sold through authorized Lowel Dealers and, in some countries, Authorized Lowel Distributors. Repairs, problems, suggestions, and requests for brochures, instructions, parts lists may be handled by your authorized Lowel Dealer (Distributor) or directly with Lowel. Electrical repairs should be made only by Lowel or a qualified electrician. Lowel DP Light is a trademark of Lowel-Light Manufacturing, Inc. Lowel Patent: D210927

Light Controls

Umbrellas



Photographic umbrellas convert relatively hard light sources, such as spotlights, into relatively soft sources that provide soft shadows and highlights. Although not appropriate for every subject or mood, the quality of light can be very beautiful. There are two umbrellas designed for use with the DP Light, a woven, silver reflective umbrella (D2-25) and a softer white nylon umbrella (D2-26) that produces a softer light and also may be used as a large diffuser (by focusing the light to flood and shooting thru the umbrella).

Warning: To prevent damage to umbrella, do not focus to spot or half-spot position as scorching of the umbrella may occur. Since the gel frame cannot be attached when the umbrella is inserted, the dichroic filter should be used for daylight correction.

Gel-brella Bracket

- A Gel frame position
- B Brella position

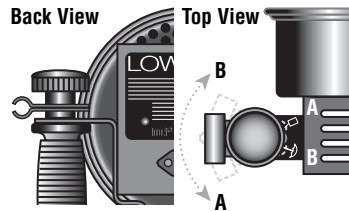

Remove entire barndoor (or just the four flaps if an accessory such as a dichroic filter is used). Set gel-brella bracket to umbrella position. Insert umbrella into bracket. Do not position umbrella further into the fixture than the automatic stop (clip) allows, or scorching may occur. Lock with knob. For best soft light effect, focus DP to full flood position.

Warning: When lights with umbrellas are extended very high, or used on undersized stands or in areas of heavy "traffic", it is advisable to add weight (such as the Lowel weight) to the base of the stand to reduce the chance of lights falling over which could damage the umbrella, the lamp and possibly cause personal injury.

DP Frame

Code: D2-24

Set Gel-brella bracket in gel frame position. Extend frame mounting bar and insert into gel-brella holder until shaft appears through opposite side. Lock with knob.

DP Gels: Gels are secured to the frame with corner spring clips. Gels should not be doubled up. Precut, tough, fade resistant Lowel gels are available in daylight blue, frost diffusion, and neutral density. When gels are used, the DP should not be spotted-down excessively. Gels can be cut into various shapes to cover only part of the frame and subject.



Tota-flag
Code: T1-52



Tota-flector
Code: T1-54



Tota flags can be used singly or snapped together end to end or side to side. Flags can be attached to the light with a flexi-



shaft. Flags block or "feather" light off background, subject, or camera lens. Tota-flectors can be attached in the same way and used to redirect some of the light. It can also provide close-up fill illumination from the sun or other source over a small area. Slight convex bowing of the surface will reduce the intensity and increase the area illumination. Avoid mounting flags or reflectors directly over people unless secured with a safety cord or cable.

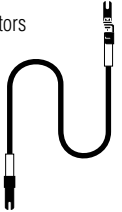

Flexi-shaft
Code: T1-50

A flexible arm positions Tota-flags and Tota-flectors. The fixed end of the Flexi-shaft snaps into a female connector on the Tota and Omni Lights, Tota-clamp and a few other Tota components the rotating end snaps on to the flag, flector etc. Avoid overstressing connectors while bending and twisting.



Tota-tatch
Code: T1-34

Spring clamp attaches Tota-flags and Tota-flectors with or without Flexi-shafts, to stands, pipes, and flat surfaces. The snap-in fitting rotates to help position flags. Tota-tatch may also be used to hold and position black & white cards, cue cards, gels, etc.

Mounts

Stands

The DP light will lock onto stands with top studs up to 5/8" (16mm). We recommend the either the Lowel KS or KS Jr. stands, provided in DP kits. Where elevation greater than nine feet is required, we recommend Lowel KS or GS Stands with Lowel Poles or Half Poles. DP lights can be positioned low on any stand with a Tota-clamp. Lowel-weights add to stand stability and should be used Tota-clamp.

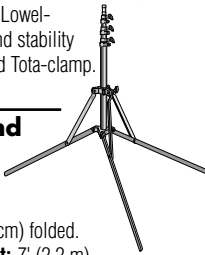

Uni Sr. Stand

Code: UN-66

Weight: 3.3 lbs (1.5 kg)

Size: 22.5" (57.2 cm) folded.

Maximum height: 7" (2.2 m)

Base diameter: 46"

Based on design of Uni-stand & KS Jr. Stand. Collapses smaller than KS Jr. Collar clamping.

KS Jr. Stand

Code: DT-33

Maximum height: 7'7" (2.3 m),

Collapsed length: 2'4" (65 cm)

Weight: 3.5 lbs (1.6 kg)

Wide based, sturdy, lightweight stand with 5/8" (1.59 cm) stud, 3 sections and solid bar legs.

KS Stand

Code: KS

Maximum height:

9' (2.74 m),

Collapsed length:

3' (91 cm)

Weight: 4 lbs (1.8 kg)

Wide based, sturdier, lightweight stand with 5/8" (1.59 cm) stud, 2 sections and tubular legs.

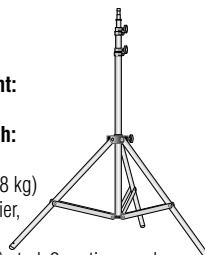

KSA Stand

Code: KSA

Same as above but black-anodized, air-cushioned stand.

Full Pole

Code: KP

Max. Ht.: 6.6' (2 m)

Folded Length: 34" (89 cm)

Weight: 1.75 lbs (.8 kg)

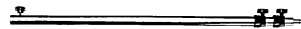

Half Pole

Code: KPH

Max. Ht.: 3' (91 cm)

Folded Length: 18" (46 cm)

Weight: 1.1 lbs (.5 kg)



Tota-clamp

Code: T1-30

Supports most lights that fit standard 5/8" studs. Tota-clamp can be attached to pipes, stands, or flat surfaces. When clamping on furniture, use thin wood or cardboard to avoid marring. To rotate stud, turn wing nut counterclockwise several turns. The stud can be locked in any of four positions; two for the 5/8" stud and two for the end with the 1/4-20 tapped hole. A 1/4-20 screw can be used to lock on some microphone yokes and various accessories. Tota-clamp has two snap-in fittings for Flexi-shafts.



Safety Cable (3)

Code: CM-50

Recommended for extra security when attaching DP lights overhead. (Set of 3).



AC Cables

16' Tota/Omni Cable

Code: T1-80

Standard #18/3; with switch.

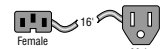

16' (5 m) Tota Eurocord

Code: T1-801

#18/3 (.75 mm/3) with double pole switch and male CEE-7 plug.

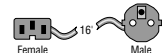

16' (5 m) Tota UK Cord

Code: T1-802

#18/3 (.75 mm/3) with double pole switch and Male fused BS 1363A plug.

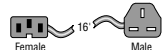

10' Unswitched Cable

Code: T1-808

For portable stage lighting use. "Hard service" #18/3 cable.

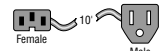

Lowel DP Light Instructions

An Introduction to DP Light for the New Pro

The wide focusing range of the DP Light makes it a flexible key, fill or back-light. Adding accessories will extend its creative possibilities.

Use the focusing knob to move from Spot (narrow beam) to Flood (wide beam). Its 8:1 focus ratio (when used with supplied #1 reflector & an FEL lamp) means that the spot setting will be approximately 8 times as bright as the flood setting.

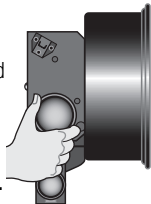

DP is an open face (lensless) fixture.

It is capable of throwing sharp shadows.

Add a diffusion glass accessory, diffusion gel with a DP Frame, or attach an umbrella to create a softer source. Use one DP without diffusion and another with diffusion, to create the classic "hard key & soft fill" lighting setup common in many interview & still life settings.

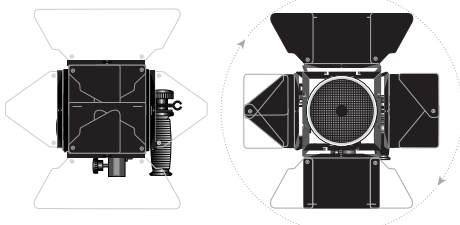

Use the rotating barndoors to trim unwanted output spill, (for example: to reduce risk of shadow in your shot caused by use of overhead boom microphones). Flexi-shafts & Tota-flags can also be attached for increased light control options.

Because the DP Light is a tungsten-halogen source, its color temperature will be in the 3000–3200°K range, depending on lamp choice. To use DP in locations where

its output will mix with daylight (5600–6500°K), its color temperature can be converted by attaching a Dichroic Filter accessory, or adding day blue gels to the DP Frame. Both will give more realistic daylight white-balancing in video or film.

To simply raise the ambient level of light in a room, point the DP Light at a white wall or ceiling (from a safe distance of several feet or more), and focus to flood setting. Position the light so it won't be in your shot.

The DP Light can use different wattage lamps, from 500–1000W @ 120V. This increases its versatility, especially when mixing with other fixtures of different max. wattages. See the lamp chart for more information.

For special use applications:



Swap to the #3 reflector for non-focusing higher output Super-Spot. This can be useful when lighting a smaller area from a greater distance when higher output is needed.

For more reduced spill, consider adding either the DP Snoot or the DP Narrow Snoot which allows front accessories, for further control options.

Other front accessories can help vary the quality of the light output. For example, the rotating half-scrim can allow you to reduce light output on a close subject while still illuminating subjects further away with full output. The full scrim reduces output without the use of a dimmer which can shift the color temperature warmer as the lamp is dimmed.

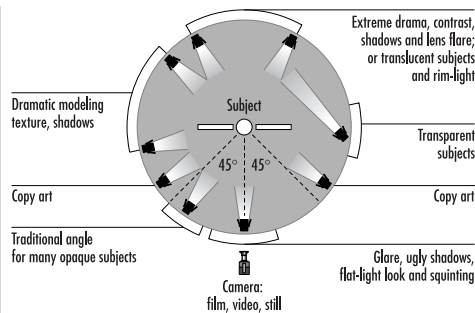

The oversimplified diagram above shows some of the ramifications of positioning lights for different subject types & lighting effects. This diagram is only useful as a starting point for new pros. All subjects & scenes are different and make different demands upon lighting. The height of the lights & camera, and the subjects angles & reflectivity must be considered.

When finished setting multiple lights, it's a good idea to check the effect of each light by powering them all down & looking at your set with one light on at a time. This will help you better understand the components of lighting and how each fixture contributes to the final image.

These are just some starting suggestions. For additional introductory information, see the Resources section of the complete Lowel catalog. For an in-depth understanding of the creative decisions involved in the art of lighting, we suggest Ross Lowell's acclaimed book, *Matters of Light & Depth*, available from many of our dealers.

Also see the evolving educational resource section of www.lowel.com

Basic Starter Setups using DP Light

These 3 setups show some ways the DP Light can be used; alone, with DP Brella, or with diffusion, in a conventional interview lighting setup. Position of the lights and distance to the subject can be varied for different creative results. Varying the distance of either light from the subject will vary the contrast ratio between Key & Fill lights. **Tip:** position your subject away from walls to avoid shadows and give a sense of more depth.

Setup Keys

- A** Key light DP with barndoors
- B** Fill light DP with umbrella

- C** Background Tota-light
- D** High back light Omni with Tota-frame & diffusion

Setup 1

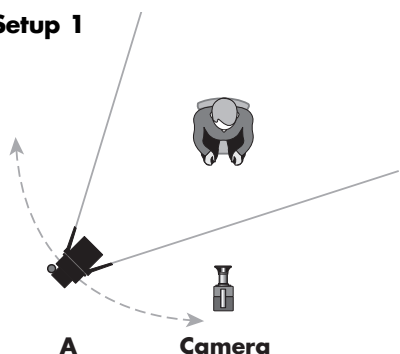

Setup #1 shows single fixture use, and can be set on either side of the camera. Varying the position of the light will increase shadow & contrast on the subject. This will give the most dramatic result.

Setup 2

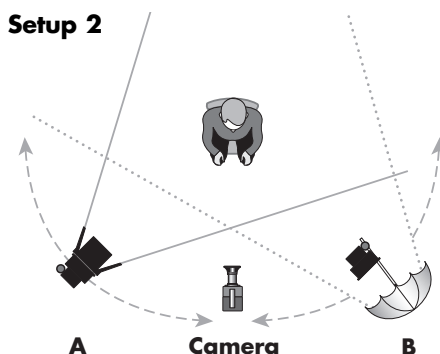

Setup #2 uses 2 DP's, one with only barn doors, as hard key, and the other with a DP Brella as soft fill. Vary the position of the lights, as shown, for a more balanced result. Beware of reflection in eyeglasses or reflective surfaces.

Setup 3

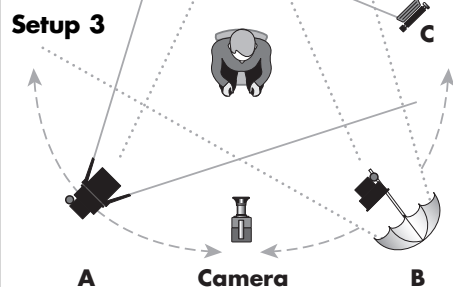

Setup #3 uses 2 DP's as hard key/soft fill, with a Tota to evenly light the background. An additional smaller light (such as the lowel Omni) from high up behind the subject as a back hair-light, lighting the back of the head & shoulders, will create a sense of separation from the background. This is a "fully lit" set. Be careful to keep the light output of the back light from spilling into the camera lens which will cause lens flare.

Lowel-Light Manufacturing, Inc.



90 Oser Avenue, Hauppauge, N.Y. 11788
 Call: 800 645-2522 or 631 273-2500
 e-mail: info@lowel.com
www.lowel.com

Version: 2.4 © Lowel-Light Mfg., Inc. 2009

430

