

## General Warnings

Lowel light stands and mounts are professional lighting tools. Read both stand and light fixture instructions & warnings before using.

- **Not for household use.** Use only for mounting of film and video lighting fixtures.
- **Do not mount** equipment that is too heavy.
- **Extend stand sections** equally.
- **Do not overextend** stands. At least 3" of each stand section should remain unextended.
- **Extend stand base** legs fully.
- **Make sure all stand** locking knobs are tight.
- **Make sure all fixture** and accessory locking screws fit into safety undercut and rotate tight.
- **Do not rig or hang** equipment directly over people.
- **Weights** should be used to increase stand stability.
- **Use a safety cable or** cord for equipment mounted overhead.

## Stand Features

All Lowel Stands and Poles are constructed with thick-wall, anodized gun-metal gray aluminum alloy tubing to deliver an exceptionally high strength-to-weight ratio.

All have a standard 5/8" (1.59 cm) top stud with safety undercut, adjustable base spread and, except for Grand Stand, collar-clamping for each segment.

All have wall thickness of .049" and are finished in gun-metal gray with yellow stand collars, except for air-cushioned stands (KSA & Grand Stand) which have black stand collars & knobs.

## Lowel-Light Manufacturing, Inc.

90 Oser Avenue,  
Hauppauge, NY 11788  
Call: 800 645-2522  
or 631 273-2500  
e-mail: info@lowel.com

www.lowel.com



## Lowel Stands

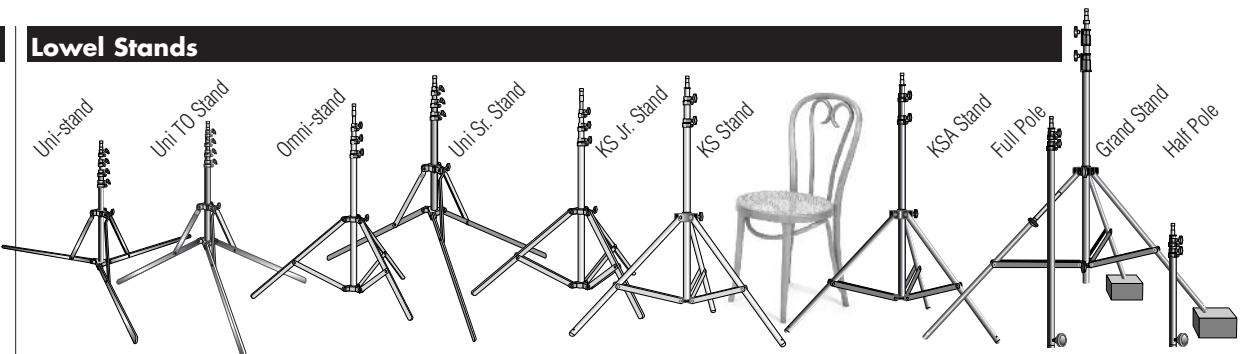

Name	Code	Max. Height	Folded Length	Max. Base Diameter	Min. Tube Diameter	Max. Tube Diameter	Weight	Legs / Number of Risers	Recommended Uses & Notes
Uni-stand	UN-33	7'11" (2.4 m)	21.5" (54.6 cm)	3'7" (1.1 m)	3/8" (.95 cm)	7/8" (2.2 cm)	2.4 lbs (1.1 kg)	Single-strut leg brace, solid bar legs. 4 Risers.	ViP & other small lights. Wide base for more stability, large locking knobs. Legs lie flat to floor or in tripod arrangement, and fold up for more compact packing. Stud has 1/4 20 thread. Smallest folding Lowel stand.
Uni TO Stand	UN-55	7'11" (2.4 m)	21.5" (54.6 cm)	3'7" (1.1 m)	1/2" (1.27 cm)	1" (2.54 cm)	2.6 lbs (1.2 kg)	Single-strut leg brace, solid bar legs. 4 Risers.	ViP, Tota/Omni, Rifa-lite 44 & other small lights. Sturdier than Uni-stand, ideal for use with Tota/Omni in GO-85 Case. Stud has 1/4 20 screw thread.
Omni-stand	O1-33	9' (2.74 m)	27" (69 cm)	3'1" (94 cm)	1/2" (1.27 cm)	7/8" (2.2 cm)	2.6 lbs (1.2 kg)	Single-strut leg brace, solid bar legs. 3 Risers.	Tota & Omni lights, Rifa-lite 44 & small flags. Sturdy & lightweight, an industry standard.
Uni Sr. Stand	UN-66	7' (2.2 m)	22.5" (57.2 cm)	3'10" (1.2 m)	3/4" (1.9 cm)	1 1/8" (2.9 cm)	3.3 lbs (1.5 kg)	Single-strut leg brace, solid bar legs. 3 Risers.	Tota/Omni, DP Light, Rifa-lite 55 & 66, Fren-L 650, Caselite, Scandles. Legs can lie flat to floor or in standard tripod arrangement, and fold up for more compact packing. Designed to fit into lid of Caselite.
KS Jr. Stand	DT-33	7'7" (2.3 m)	28" (65 cm)	3'1" (99 cm)	3/4" (1.9 cm)	1 1/8" (2.9 cm)	3.5 lbs (1.6 kg)	Single-strut leg brace, solid bar legs. 3 Risers.	Tota/Omni, DP Light, Rifa-lite 55 & 66, Fren-L 650, Caselite, Scandles. Smaller closed than KS (for more compact packing).
KS Stand	KS	9' (2.7 m)	36" (91 cm)	3'5" (1 m)	7/8" (2.2 cm)	1 1/8" (2.9 cm)	4 lbs (1.8 kg)	Double-strut leg brace, tubular legs with holes for casters or anchors. 2 Risers.	DP Light, Rifa-lite 88, Fren-L 650, Basic Boom. Industry standard medium sized stand, taller & more stable than KS Jr. KSA is same as KS but with air-cushioned riser sections, black castings & knobs.
KSA Stand	KSA								
Grand Stand	GS	10.5' (3.1 m)	43" (1.1 m)	4'5" (1.35 m)	1" (2.54 cm)	1 3/8" (3.51 cm)	6.75 lbs (3 kg)	Double-strut leg brace, tubular legs with holes for casters or anchors. 2 Risers.	Variflector, larger/heavier lights, Big Boom. Extra wide base, one leg extends longer for use on uneven ground, gray anodized stand with air-cushioned sections & direct screw clamping.
Full Pole	KP	6.6' (2 m)	34" (89 cm)		7/8" (2.2 cm)	1 1/8" (2.9 cm)	1.75 lbs (.8 kg)	2 Risers (3 sections).	Extend KS, Grand Stand. Forms: boom, background support, rigs. Updated with extra section & additional length for added security when used at original length.
Half Pole	KPH	3' (91 cm)	18" (46 cm)		7/8" (2.2 cm)	1 1/8" (2.9 cm)	1.1 lbs (.5 kg)	2 Risers (3 sections).	Same as Full Pole.

## Stand Use Notes

### Uni, Uni TO & Uni Sr. Stands

Extend stand legs fully as shown for maximum stability. When extending stand sections to desired height, begin with lowest section first. Don't fully extend any section unless necessary. When using with Tota/Omni, extending top section of stand may result in some loss of stability. With Tota-light mounted, rotate light head so it lines up in parallel with one of the legs for most stable balance. **Fig. A** The 3 Uni-stands can be set up with its legs extended in tripod fashion or **Fig. B**, set flat on the floor depending on the users need for stability vs. height.

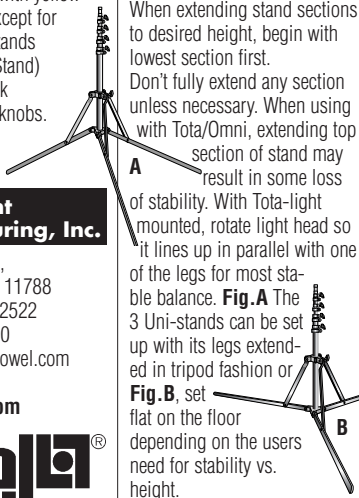

### Packing up

When collapsing the Uni-stands, line up all rotating stand locking collars (collars are marked A, B, & C) with the lowest locking collar in the center shaft (collar is non-rotating & marked D). Slide stand legs into notched slots. Tighten all knobs.

This will allow proper fit of Uni-stand leg as it folds in against center shaft & locking collars.

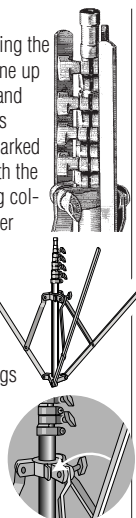

### Omni-stand, KS & KS Jr. Stands

When extending stand sections to desired height, begin with lowest section first. Don't fully extend any section unless necessary. See chart above for maximum heights. When heights greater than 9 feet are required, use the KS or KSA Stand with a Lowel Full or Half Pole.

### Grand Stand & KSA Stand

The Grand Stand and KSA Stand both feature air cushioning which allows the stand section to descend gently, preventing lamp damage. All Lowel air-cushioned stands have collars & locking knobs that are black-finished. Both stands have two holes in the bottom of their legs that

accept Lowel Anchors and Casters.

The Grand Stand has an extendible leg that can be used to keep the stand vertical on uneven surfaces (steps, hills, etc.). The Grand Stand can also be nailed to platforms when necessary.

When extending stand sections to desired height, begin with lowest section first. Don't fully extend any section unless necessary.

### Full Pole & Half Pole

Lowel Poles can be used to extend Lowel Grand Stands, KS and KSA Stands, to hand-hold a light above crowds, to extend lights down from overhead clamps,

and to form booms, rigs and various mounting and adjusting devices.

## Problems, info, etc.

Lowel equipment and kits are sold through authorized Lowel Dealers and, in some countries, Authorized Lowel Distributors. Repairs, problems, suggestions, and requests for brochures, instructions, parts lists may be handled by your authorized Lowel Dealer (Distributor) or directly with Lowel. Electrical repairs should be made only by Lowel or a qualified electrician.

ver: 5.1 © 2006 Lowel-Light Mfg., Inc.

984



# Lowel Stand Accessories Instructions

## Stand Accessories

### Lowel Weight

**Code:**  
**LW**

**Weight:** 4.25 lbs (1.93 kg)  
Modular counterweight. A 5/8" (1.59 cm) stud locks on female end of Lowel poles to counterbalance booms. Two or three weights fit together. For additional ballast, tighten knob securely to hold weights together. Slots in bottom fit on stand leg struts to increase stability.



### Lowel Casters (3)

**Code:** LC  
**Weight:**

2.4 lbs (1.09 kg)  
Lockable wheels fit leg holes on

KS, KSA and Grand Stands. Especially helpful for booms and studio lighting. (Set of 3). Unscrew wing-nut bolt, place stud thru leg hole, attach wing-nut & tighten.



### Lowel Anchors

**Code:** LA (Set of 4)

Ground spikes fit through leg holes in KS, KSA and Grand stands to increase stability when used on grass, sand etc. and are recommended especially when reflectors are used. A hand, foot or rock can be used to force the Anchor through the holes in the legs and into the ground.



### Ceiling Link

**Code:** KCL

Set includes one male **A**, one female **B**.

Holds one or more lights with Lowel Clamps and Grips.

The female half of the set can be attached to a stand to secure it against a ceiling.

Rubber and aluminum components lock onto ends of Lowel poles. Compression secures rig in place to make floor to ceiling poles.

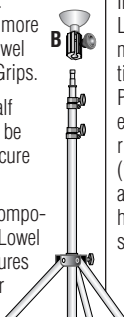
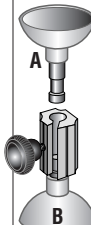

## Interlink System

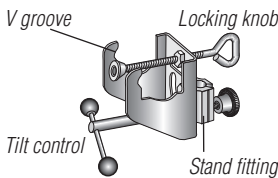

### Lowel Grip

**Code:** KG

This versatile clamp attaches to stands, poles, pipes, 2" x 4"s etc. to support lights with Interlink; makes a boom out of Stand and Pole; works with Space-clamp, Maxa-mount, Frame-up. Tilts 180°; pans 360° and locks securely.

### Lowel Interlink

**Code:** K1-10

Interconnects various Lowel components. Adds multiple mounting positions; joins two Lowel Poles (male or female ends) in a straight line or at right angles (90°). Both 5/8" (16mm) studs are removable and have a 1/4-20 threaded hole to simplify mounting accessories with 1/4-20 bolts.

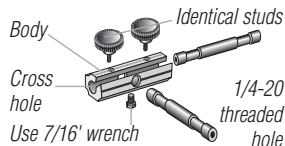
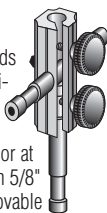

**The three main parts of the Interlink can be used together or separately.**

The following are a few of the various Interlink combinations.



**Stud** can connect the female ends of two Lowel Poles (or other components).



**Body** can interlock two male ends of Lowel Poles (or other components) such as clamps.



**Full Interlink** can connect the female ends of Lowel Poles (or other components) at 90° (right) angle.

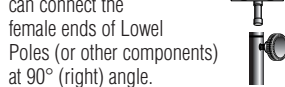

**Body** can connect the male end of Poles, or a Stand and Pole, to form a 90° (right) angle.

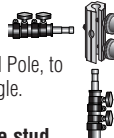

**Interlink or just the stud** can be locked into the 5/8" female connection on a Lowel Grip and the assembly can then be clamped onto any part of any stand, pipe, 2x4 etc. A light or another Grip can be attached to the stud.

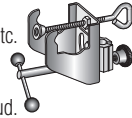

**Interlink** can be locked onto a Tota-clamp **A**, Lowel Grip **B**, or various accessories.

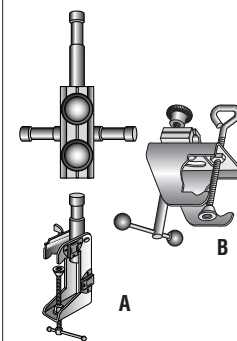

## Booms, Supports & Rigs

The following booms are assembled from components described on this sheet. The same components can be used individually and in other combinations, as required. The equipment may also be extended or adapted using additional Lowel components (see "Stands, Poles, Booms, Rigs" sections at lowel.com or in Lowel Catalog). Also, see "Warnings" on front page.

### Basic Boom

**Code:** SP-91

- 1 KSA Stand (KSA)
- 1 Grip (KG)
- 1 Full Pole (KP)
- 2 Lowel Weights (LW)
- 1 Set (3) Lowel Casters (LC)
- 1 Pkg (10) Cable Clips (K4CC)

### Big Boom

**Code:** SP-90

- 1 Grand Stand (GS)
- 1 Grip (KG)
- 1 Full Pole (KP)
- 2 Lowel Weights (LW)
- 1 Set (3) Lowel Casters (LC)
- 1 Pkg (10) Cable Clips (K4CC)

*Tighten all knobs adequately with hand leverage only. Never raise stand or adjust boom while people are under it.*

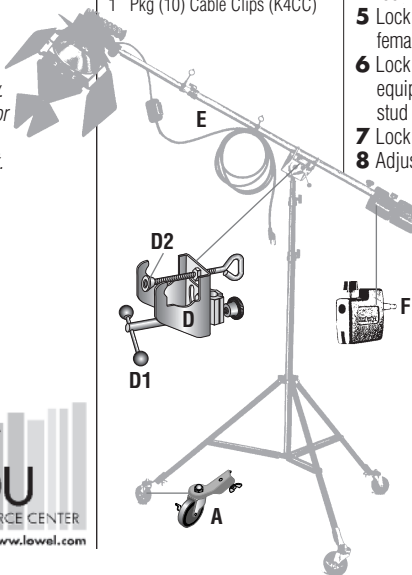

### Putting together a Boom

- 1 Assemble casters **A** to stand **B** through holes in end of legs and tighten wing nuts.
- 2 Lock Grip **D** onto stud and lock tilt control **D1**, at convenient angle, using knob with balls on ends.
- 3 Extend pole **E** half way; insert it into V portion of Grip **D2**; cradle and tighten lock knob.
- 4 Lock one weight **F** into female end of pole.
- 5 Lock light or other equipment onto 5/8" male stud on boom.
- 6 Lock in second weight.
- 7 Adjust for balance using extension on pole or move entire Pole within Grip.

### Background Support

**Code:** SP-93

- 2 KS Stands (KS)
- 2 Interlinks (K1-10)
- 2 Full Poles (KP)

This versatile rig supports seamless paper rolls, black velour, other material, adjusts from 32" (81.3 cm) to 10' (3.05 m) wide. Accepts two back lights without additional clamps; components can be used separately as well.

- 1 Attach Interlink **A** to one stand, Interlink **B** to other stand.
- 2 Remove cross stud from Interlink **B** by loosening retaining bolt with 7/16" wrench or Vise-grip.

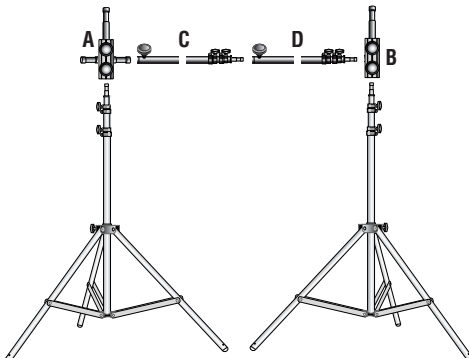

- 3 If seamless paper is to be used, insert pole or two interlocked poles **C** and **D** (or pipes if preferred) through roll. (*Some small diameter cardboard tubes may necessitate substituting 1/4-20 bolts for knobs on poles.*)
- 4 Lock poles to Interlinks. Elevate both stands simultaneously, if possible.

Other materials suitable for background or blocking or diffusing light may be clamped or taped to poles. Lights may be mounted to studs projecting from Interlinks and will be well positioned for backlight sources.

### Floor-to-Ceiling Pole

- 1 Assemble required number of poles **H** and/or half poles **I** to reach vertical span.
- 2 Lock on ceiling link **F** and **G** at opposite ends.
- 3 To hold securely, cups on ceiling link must be flattened completely against floor and ceiling. This is most easily done by pressing down with a foot while extending a pole section with one hand and locking collar clamp on pole with the other hand. Lights that are not too heavy can be attached with suitable clamps such as the Tota-clamp.
- 4 An Interlink **J** inserted between pole and top ceiling link can also support a light.

*Caution: Test for safety of installation and never use poles horizontally.*

