

Lowel PRO™ Power LED

Today's Run & Gun Lighting Solution

The Lowel PRO™ Power LED is the perfect solution to run & gun location lighting. Its powerful output and wide focus range fresnel lens allow you to light from greater distance, getting more of the location into your shot.



Features

- Light from close up or further away, the PRO Power LED's beautiful Fresnel output focuses wide & smooth, or tight & punchy, for creative versatility
- Powerful location LED in high quality Daylight or Tungsten, dimmable without color shift
- Flicker-free Slo-mo, 2350+ fps
- Powered by AC or Long Life DC Battery, for stand or run & gun handheld use
- Light Controls include: Barndoors, gel frame, softbox, screwthread filters
- Kit combinations available

LOWEL PRO™ Power LED

Lowel PRO Power LED (Daylight or Tungsten color)

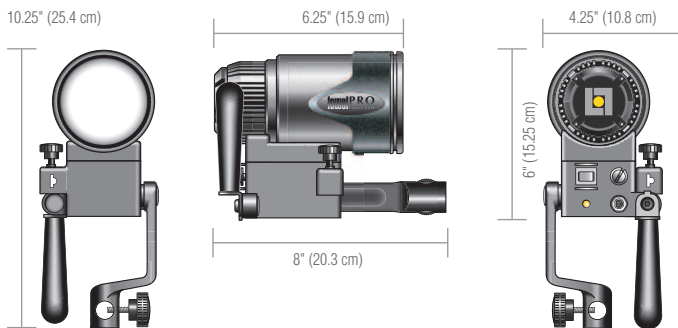

Lowel PRO Power LED

Tungsten Code: G5-10TU

Daylight Code: G5-10DA

Weight (w/barndoors): 3.3 lbs (1.5 kg); 1 Lowel PRO LED (Tungsten or Daylight) with auto-setting AC adaptor (G5-80), and 2 Way Barndoors (G5-25)

Voltage: 24 V **Wattage:** 22.4 W

Amperage: .7 A

Beam control: Continuously variable

Fits on: 5/8 stand studs, also 1/4-20

Pistol Grip mount

Materials: Primarily aluminum steel, & glass-filled nylon

Dimming Control & Switch: in-unit

Performance

Foot Candles (lux = foot candles x 10.8)

Flood 56 15 7 4 2

Spot 397 91 40 22 14

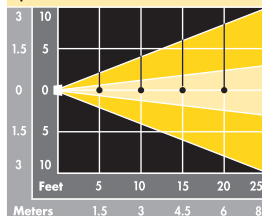

Tungsten Model output measured with Minlota T-200 meter
Output comparable to 100W tungsten halogen lamp at same focus range & beam angle

Color Rendering Index: 95 (measured w/ tungsten model)

Installed LED Lumen information:
2292 lumens (3000K Tungsten Model); 2500 lumens (5000K Daylight Model); at 700mA drive current (17.6W)

DC Power Accessory

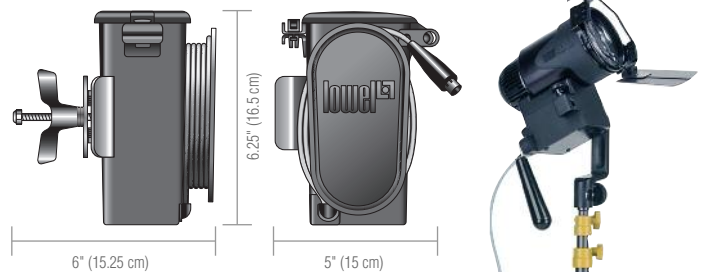

Lowel PRO Accessory Battery System

Code: G5-156

Weight: 3.6 lbs (1.6 kg)

Battery box with 7ft DC cord, attached stand mount clamp, air-cushioned shoulder strap, and removable GL-Pro Long Life Battery (G5-15). Supplied with Lowel Rapid Charger 100 (G5-18)

Lowel PRO Spare Battery

Code: G5-15

Weight: 1.5 lbs (.7 kg)

Lowel PRO Spare Battery Box

Code: G5-17

Weight: 1.3 lbs (.6kg)

Rapid Charger 100

Code: G1-18

Weight: .8 lbs (.4 kg)



Light Control Accessories

PRO Power LED Softbox

Code: G5-30

Weight: 1.2 lbs (.6 kg)

Collapsible softbox attaches easily to PRO Power LED Accessory slot and sets up quickly, to give soft flattering output.



PRO LED 2 Way Expanding Barndoors

Code: G5-25

Weight: 6 oz (170 g)

Barndoor Frame with two expandable clip-on doors (G5-24). Rotates 360°.

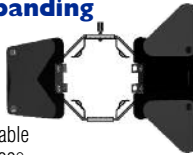

PRO Expandable Barndoor Leaf

Code: G5-24

PRO Power LED Gel Frame

Code: G5-40

Attaches to PRO LED accessory slot. Holds 5 x 6" gels. Collapses for storage.

PRO LED Correction Gel Sets

Code: G5-78

1 ea. - Full, 1/2, & 1/4 Day Blue, 2 Frost For correcting tungsten to daylight color

Code: G5-79

1 ea. - Full, 1/2, & 1/4 CTO (orange), 2 Frost For correcting daylight to tungsten color

Tota-brellas, Reflective Silver & White Nylon

Codes: T1-25 (silver), T1-26 (white)

Weight: 8 oz (227 g)

Size: 27" (68.6 cm) open, 19" (48.3 cm) closed.

Attaches easily to Lowel PRO LED accessory slot.

82mm Screw-thread Color Conversion Filters

Fits screw-thread in front of light

Tiffen 82B Daylight Conversion Filter 8280B

Tiffen 85B Tungsten Conversion Filter 8285

Mounting Accessories

Uni TO Stand

Code: UN-55

Weight: 2.6 lbs (1.2 kg)

Size: 21.5" (54.6 cm) folded.

Maximum height:

7'11" (2.4 m)

Base diameter: 43"

Single-strut leg brace, solid bar legs. 4 Risers.



Tota-clamp

Code: T1-30

Weight: 4 oz (113 g)

Clamps onto pipes and objects up to 1 7/8" (4.8 cm) thick.

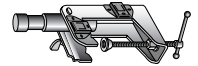

Lowel PRO Handle

Code: G5-41

For hand holding Lowel PRO Power LED. Handle with 1/4-20 screw-threaded post, attaches to underside of light.



2 Light AC Kit

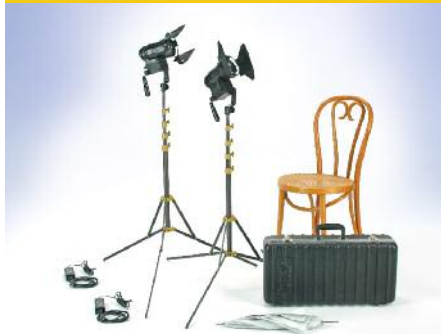

With GO-85 Hard Case

Tungsten Color Kit
Code: G5-92TU

Daylight Color Kit
Code: G5-92DA

Size: 23.8 x 12.8 x 7.9"
(60.5 x 32.5 x 20.1 cm)

Contains:

- 2 Lowel PRO Power LED fixtures, complete (G5-10TU or G5-10DA)
- 2 Uni TO Stands (UN-55)
- 1 Tota-brella (T1-25)
- 1 GO-85 Hard Case (GO-85)

With LB-30 Soft Case

Tungsten Color Kit
Code: G5-92TULB

Daylight Color Kit
Code: G5-92DALB

Size: 23 x 10.5 x 6.75"
(58.4 x 26.7 x 17.2 cm)

3 Light AC Kit



Tungsten Color Kit
Code: G5-93TU

Daylight Color Kit
Code: G5-93DA

Size: 29.5 x 17 x 7"
(74.9 x 43.2 x 17.8 cm)

Contains:

- 3 Lowel PRO Power LED fixtures, complete (G5-10TU or G5-10DA)
- 3 Uni TO Stands (UN-55)
- 1 PRO Power LED Softbox (G5-30)
- 1 Accessory Gel Set (IP-78 - tungsten kits, or G5-79 - daylight kits)
- 1 PRO Power LED Gel Frame (G5-40)
- 1 Tota-brella (T1-25)
- 1 TO-84Z Hard Case (TO-84Z)

2 Light AC / DC Kit



Tungsten Color Kit
Code: G5-92DCTU

Daylight Color Kit
Code: G5-92DCDA

Size: 29.5 x 17 x 7"
(74.9 x 43.2 x 17.8 cm)

Contains:

- 2 Lowel PRO Power LED fixtures, complete (G5-10TU or G5-10DA)
- 2 Uni TO Stands (UN-55)
- 2 Lowel PRO Accessory Battery Systems (G2-156)
- 1 TO-84Z Hard Case (TO-84Z)

Accessory DC Power Kits

The perfect accessory companions to the 2 or 3 light AC kits, for times when you need DC power. Each DC kit has room for additional batteries

Lowel PRO LED 2 Battery Kit

Code: G5-98DC

Size: 29.5 x 17 x 7"
(74.9 x 43.2 x 17.8 cm)

Contains:

- 2 Lowel PRO Accessory Battery Systems, complete (G5-156)
- 1 Slim Litebag Soft Case (LB-24)

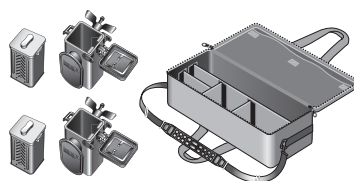

Lowel PRO LED 3 Battery Kit

Code: G5-99DC

Size: 29.5 x 17 x 7"
(74.9 x 43.2 x 17.8 cm)

Contains:

- 3 Lowel PRO Accessory Battery Systems, complete (G5-156)
- 1 Slim Litebag Soft Case (LB-24)

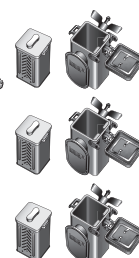

Lowel-Light Manufacturing, Inc.

90 Oser Avenue, Hauppauge, NY, 11788

Call: 800 645-2522 • 631 273-2500

www.lowel.com

Technology From Tiffen

lowel