

Lowel i & id-light Instructions

Warnings

The Lowel i & id-lights are professional DC powered lighting fixtures. Read these instructions and lamp manufacturer's warnings before operating.

- **Not for house hold use, use only** for film, video or imaging purposes.
- **The units use lamps of several different voltages.** Make certain that power source voltage matches lamp voltage. Example: never connect a 12 volt lamp to a 30 volt source.
- **Do not use near standing water,** or in rain.
- **Units such as this emit** considerable light and heat, and if not properly used, could be dangerous.
- **Lights should not be positioned** extremely close to people. Ultraviolet light ray emissions can cause damage to the eyes and reddening of the skin. The likelihood of either occurring is increased with length of exposure, focus intensity and proximity. Therefore, lights should be kept away from people.
- **Avoid aiming the light at, or placing** too close to, people, delicate objects or flammable materials.
- **Do not interfere with ventilation** by covering the lights in any way.
- **For proper ventilation, do not tilt** down beyond 45 degrees or operate sideways.

Yes

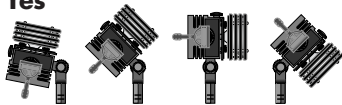

No

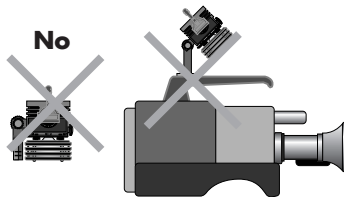

- **Do not tilt light down** if mounted on top of a camera, while illuminated. Camera damage could result.
- **Do not leave fixtures unattended.**
- **Unplug fixtures when not in use.**
- **Never touch hot parts only touch** handles & knobs for light adjustments.
- **Do not touch i or id-light upper front** end knob while operating the light, high temperature is present.
- **Lights should be operated with lamp** filament horizontal.
- **Avoid mounting lights directly over** people unless secured with a safety cord or cable.
- **Keep light power cable away** from front housing when hot, to avoid damage.
- **Never store i or id-light** without first removing the power cable from the power source.

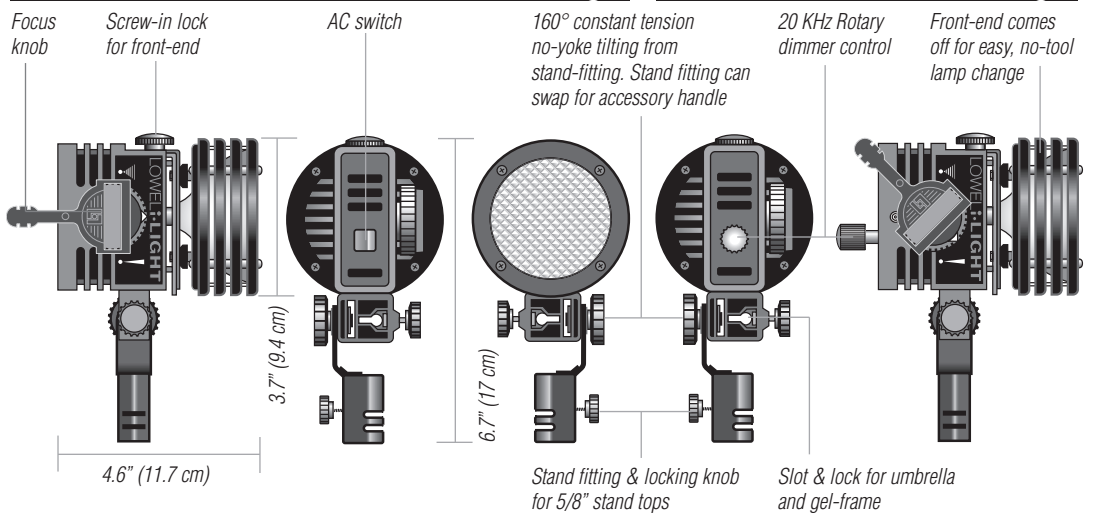

i-light Technical Data

Weight:

i-light with 4' cable:

1.2 lbs (544 g)

id-light with 4' cable:

1.5 lbs (635 g)

Max wattage: 100

Max amperage: 8.3

Beam control:

continuously variable
Fits on: stands, studs, camera tops, etc.

Materials: primarily aluminum and Ryton

Cable: 4' (1.25 m) #16/2 with cigarette lighter connector CE Model with #18/2 cable
Switch: in-head
U.S. Patent: 4777566



Lamp/Beam Data

Lamp Code	Volts	Watts	°K	Avg Life	Flood	F. C. (lux) at 10' (3 m)		
						Spot	Focus Range	Super Spot
i-100	12/14	100	3200	500 hr*	9 (99)	40 (430)	5:1	167 (1800)
i-55	12/14	55	3200	500 hr*	4 (40)	29 (315)	8:1	120 (1300)

*At 12v.

i & id Lamp Replacement

- 1 Turn focusing knob **A** to spot position.
- 2 Unscrew the small knob **B** located on top of the front reflector assembly. Remove front assembly by tilting "downward".
- 3 Holding the focus knob in spot position grasp the rear metal portion of the lamp **C** and push in.
- 4 This will release the two "dimple" studs **D** which seat the lamp in its socket.
- 5 While continuing to push the lamp assembly **E** in, gently slide it upwards and out of the socket. Slowly pull the lamp forward slightly. This will expose a single-wire connector **F**.
- 6 Separate the lamp from the single-wire connector. Make sure single-wire connector does not fall back into the lamp housing.
- 7 Connect this wire to the replacement lamp. Align connected lamp with the flat side of the metal lamp base facing down (the 4 o'clock position).
- 8 While pushing in, gently slide the lamp downwards until the two "dimple" studs are seated in the socket.
- 9 Replace the front reflector assembly and tighten the top knob.

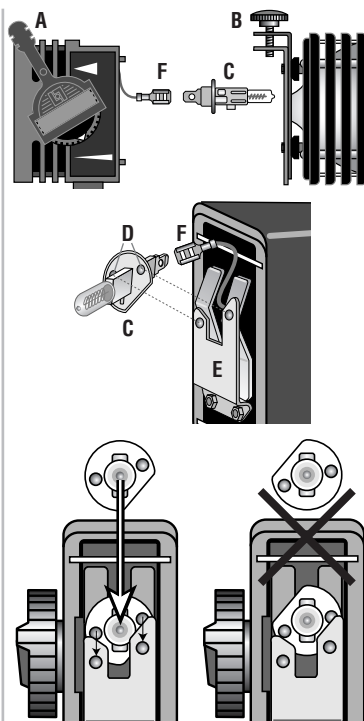

id-light

Performance

With 12v, 100w, 3200°K, i-100 lamp

Foot Candles (Lux = foot candles x 10.8)	31	9	4	2	1.5
Flood					
Spot	157	40	16	10	6
Super Spot with clear safety glass	648	167	65	39	26

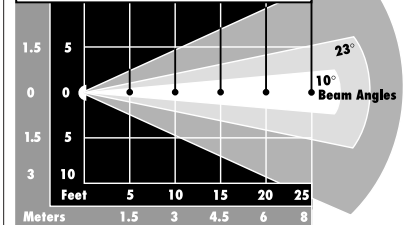

Beam angles-points at which intensity drops to 50% of maximum

i & id Power Cable & Connectors

The i-light standard power cable terminates in a standard cigarette lighter plug. Special i-lights are available with 4-pin XLR, or Anton Bauer (2 pin battery plate, camera) cable connectors.

i & id-light Connector

i-86 Anton Bauer Battery Tap

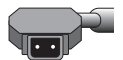

The Anton Bauer connector can be supplied by a Lowel Dealer or directly from Lowel for installation by a qualified electrician.

NOTE: If you connect a battery with reversed polarity (plus is minus / minus is plus) to the id-light, the fixture will not light, and a red warning LED will illuminate on the side of the fixture.



Lowel i & id-light Instructions

Light Controls

i & id- lights are supplied with the iP #2 Reflector

This computer designed, faceted high intensity reflector gives improved light output. It can be used with either the supplied Prismatic Glass (focusing) or Clear Safety Glass (high intensity non-focusing super-spot only). *Never operate Pro or i / id-lights without prismatic or safety glass installed.*

Changing Pro & i / id Front Housing Glass

(Prismatic or Clear Safety)

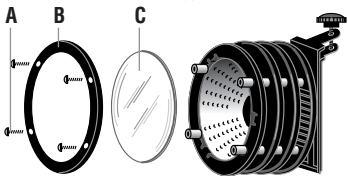

- 1 Remove the four screws **A** located on the front of the light and lift off the cover plate **B**, and the Prismatic Glass **C**
- 2 Replace the Prismatic glass with Clear Safety Glass. Reassemble in reverse.

Another option is to purchase the #2 Reflector with Front Housing & Safety Glass Code: iP2-19

Pro & i / id Focusing and Focus Knob Extension Code: iP-35

Turning focusing knob, located on the side of the housing, alters



the beam of light from flood to spot. A focus knob extension accessory snaps into focus knob for left-hand or on-camera focusing.

Compact filament lamps may fail if subjected to shock or vibration while on. Operating the focus smoothly will help prevent lamp failure.

Attaching gel frames & umbrellas

i & id-lights have a Universal Mounting Bracket (UMB) **A** located below the fixtures adjacent to the stand fitting **B**. It facilitates the mounting of i / id & other ViP Lights to stands and accepts several light control accessories.

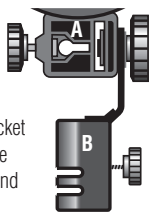

Pro-light & i-light Barndoors

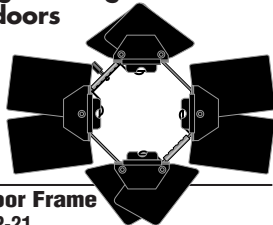

Barndoor Frame Code: iP-21

Accepts swing-in accessories, and/or leaves. Rotates 360°.

Attaching the Barndoor Frame

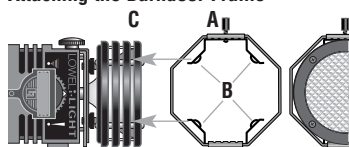

to the front of the light with and without barndoors.

- 1 Loosen the knob **A** on the Barndoor Frame.
- 2 Set the frame clamp retaining feet **B** into the first ventilation groove **C** of the light.
- 3 Tighten knob. Proper installation allows full 360-degree rotation of the complete barndoor assembly.

Attaching the leaves to the Barndoor

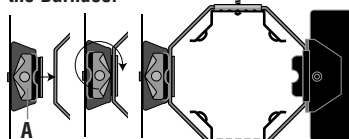

Expandable Leaves and Nonexpandable barndoors are attached to the frame by constant-tension lock fasteners **A** located on the rear of the doors. The lock fasteners require a 1/2 (180-degree) turn to remove or install the barndoors. Lock fasteners should be on the "inside" of the barndoor flap. It is possible to install a barndoor leaf backwards so that it will not close over the light. It is important to align the barndoor leaf to the frame.

2-way Barndoor Code: iP-25

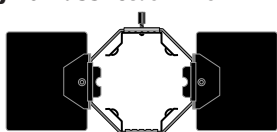

Barndoor Frame with two removable non-expandable leaves. Frame accepts swing-in accessories and additional leaves. Rotates 360°.

Expandable Rectangular Leaf Code: iP-22

Changes from small to large rectangle.



Expandable Triangular Leaf Code: iP-23

Changes from triangular to square shape.



Non-expandable Clip-on leaf Code: iP-24

Rectangular leaf. Can be attached to, or removed from, Barndoor Frame.



Gel-Jawz Code: CL-15

Attach to barndoor leaves to hold gels. Use two per light.

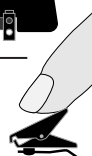

Swing-in Accessory Holder Code: iP-30

Accessories, attaches to the Barndoor Frame in a similar manner as the barndoor leaf. Align Accessory Holder on Barndoor Frame. The lock fastener requires a 1/2 (180-degree) turn to remove or install the Accessory Holder. When in use, Accessory Holder swings over the light and locks onto the other side of the frame. Three holders can be attached to the Barndoor Frame simultaneously, but only one can be used at a time. A full barndoor set and a single holder can be used at once. Quickly swinging one holder out of position and swinging in another is a valuable user convenience.

Changing Light Control Accessories



Simply release the captive retaining spring clip located inside the Holder and remove accessory. Insert new accessory and secure retaining spring clip. A scrim and glass accessory may be mounted together in a single Accessory Holder. Separate holders for each accessory are recommended for fast in-use changes.

Swing-in Accessories

Diffused Glass Code: iP-50
softens highlights and shadows. Absorbs U.V. light rays Light loss approximately 40%.

iP Prismatic Glass Code: iP-52
Supplied with all Pro & i-lights. Gives an evenly dispersed flood, produces a more uniform spot and a fresnel-like barndoor cut. When used in holder with Clear Safety Glass (iP-49) installed in front housing, allows focusing use when swung in & super spot use when swung out.

Dichroic Filter Code: iP-51
converts 3200 K lamps to average daylight; absorbs U.V. light rays Light loss approximately 65%.

Full Scrim Code: iP-54
reduces light by approximately one stop.

Half Scrim Code: iP-55
covers half of reflector and rotates 360° darkens washed out foregrounds, compensates for actors "burning up" as they approach a light.

Graduated Scrim Code: iP-56
same principle as half scrim but effect is more gradual and more extreme.

Snoot Code: iP-53
Produces a reduced circle of light; Barndoors and barndoor accessories may also be added to the end of the Snoot. A Snoot attaches to the light in the same manner as does a Barndoor Frame. iP Snoots can be "piggy-backed."

Pro & i Gel Frame Code: iP-40

Holds 5 x 6" gels. Unfold frame, extending frame bar and insert through front slot of UMB Lock with knob. Pans and tilts with the light, collapses for storage.

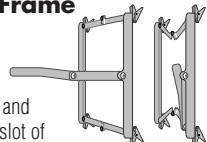

Pro & i Gels

Size: 5 x 6" (12.52 x 15.25 cm) sheets

Tota-brella



Photographic umbrellas convert relatively hard light sources, such as spotlights, into relatively soft sources that provide soft shadows and highlights. Although not appropriate for every subject or mood, the quality of light can be very beautiful. There are two umbrellas suitable for use with the i & id lights:

Silver (Code: T1-25), reflective umbrella.
White (Code: T1-26), a white nylon umbrella that produces a softer light and also may be used as a large diffuser. To mount umbrella insert umbrella shaft through round hole in UMB and lock with knob. Tota-brella and Tota-frame cannot be used simultaneously.

Warning - When lights with umbrellas are extended very high, or used on undersized stands or in areas of heavy "traffic", it is advisable to add weight (such as the Lowel weight) to the base of the stand to reduce the chance of lights falling over which could damage the umbrella, the lamp and possibly cause personal injury.

Warning - To prevent possible umbrella damage, avoid full or near-full spot reflector settings on the i or id-light and do not use with a Clear Glass as Super-spot.

Stands

The i & id-lights will lock onto stands with top studs up to 5/8" (16mm). We recommend the Uni-stand or Uni TO Stand, for most applications. Where elevation greater than 7' 9" is required, we recommend Lowel KS stands with Half or Full Poles. i or id-lights can be positioned low on any stand with a Tota-clamp. Lowel-weights add to stand stability and should be used when appropriate.

Uni-stand

Code: UN-33

Size: 21.5" (54.6 cm) folded. Extends to 7'11"

All aluminum stand, wide base, legs can lie flat to floor, large locking knobs. Folds compactly to fit in smaller kits.

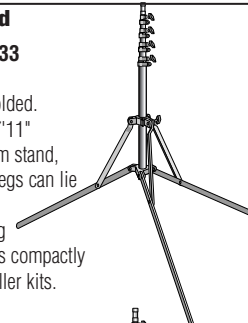

Uni TO Stand

Code: UN-55

Size: 21.5" (54.6 cm) folded.

Maximum height: 7'11" (2.4 m)

Base diameter: 43"

New stand, based on design combination of Uni-stand & Omni-stand. More stable than Uni-stand, more compact than Omni Stand.

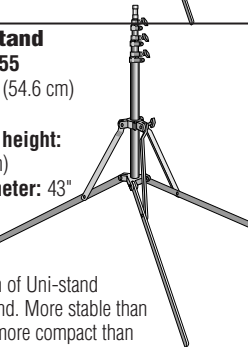

Vipod & Stud-link

Code: ViP-35S

Supports i / id or other ViP Lights on flat surfaces. Vipod can be screwed, Gaffer-taped or clamped to vertical surfaces. Stud-link is removable. The Low Link can also be mounted on the Vipod by attaching the Low link to the Vipod using the knob provided with the Lowel link.

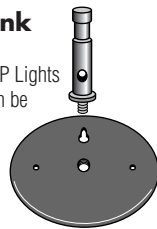

Tota-mount

Code: T1-32

Tota-mount supports any of the ViP fixtures atop doors and partitions. Doors can be open or closed. The light can be inside or outside room, since swinging arm extends past most door jambs. Tota-mount can be flipped over and nailed to studio set walls or Gaffer-taped to windows or tile, wood, metal and other wall surfaces.

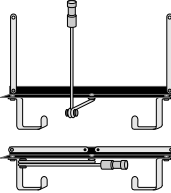

Mounting Tota-mount & Vipod with Gaffer Tape

Use 12" of Gaffer-tape on each bar on Tota Mount or side of Vipod and burnish down with a coin. Avoid wallpaper,



soft composition board or flaking paint. Never attach to the ceiling with tape. Use original Lowel Gaffer-tape. Many substitutes leave adhesive residue or lack sufficient strength. When properly attached, Tota-mount or Vipod will support the light for days. However, on dirty or poorly bonded surfaces, or with improper or poorly applied tape, there is the danger of the mount falling down and causing serious damage. Check adhesion periodically. Prevent direct light from overheating tape. Remove tape when cool, by peeling back diagonally. Tota-mount should not be used with lights heavier than 3 lbs. (1.33 kg)

Tota-clamp

Code: T1-30

Tota-clamp supports most lights that fit standard 5/8" studs. Tota-clamp can be attached to pipes, stands, or flat surfaces. When clamping on furniture, use thin wood or cardboard to avoid marring. To rotate stud, turn wing nut counterclockwise several turns. The stud can be locked in any of four positions; two for the 5/8" stud and two for the end with the 1/4-20 tapped hole. A 1/4-20 screw can be used to lock on some microphone yokes and various accessories. Tota-clamp has two snap-in fittings for Flexi-shafts.

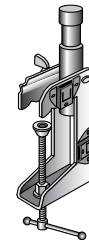

Scissor Mount

Code: CM-20

Attaches i or id-lights, and V-lights to dropped ceiling: Clamp X bars of grid lock to T-Bar of ceiling. Attach fixture to mount stud and tighten. Pro lights should use the Grid Lock for dropped ceiling mounting. Avoid mounting fixtures directly over people unless secured with a safety cord or cable.

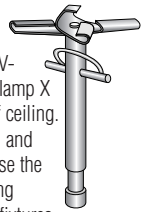

Professional Camera & Handheld Mount Options

Caution: Camera damage may result if light is pointed down while lamp is on.

L-link

Code: ViP-36

Can be used to extend i or id-lights from Cam-links and Vipods. To use, mount short leg of L-link on to Cam-link or Vipod using the knob provided. Remove Stand-link from fixture by loosening the large knob, attach light to upper part of slot with the large knob.

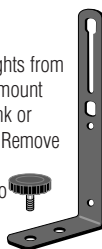

Low-link

Code: ViP-37

Enables i & id-lights to be mounted on Cam-links and Vipods.

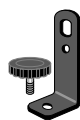

Stud-link

Code: ViP-38

5/8" (16mm) stud with 1/4-20 male screw, used to mount fixtures with Stand-link to cameras with proper female socket.



Cam-link

Code: ViP-41

Male "shoe" fitting locks into cameras with proper female shoe mount. Accepts Stud-link Low-link or L-link.



Cam & Stud-link

Code: ViP-41S

For mounting fixtures with Stand-link on cameras with proper female shoe mount. Slide Cam-link onto camera shoe, screw Stud-link into top of Cam-link to tighten. Do not over tighten! Mount light on stud and secure by tightening Stand-link lock knob.

Cam & Low-link

Code: ViP-41L

For mounting fixtures directly on cameras with proper female shoe mount. Remove Stand-link from fixture by undoing the large attaching knob located on the side of the fixture. Attach low link using the upper hole and with the "leg" facing "under" with the large knob. Mount the Fixture/ Low-link assembly to the Cam-link, using the knob provided. Slide the Cam-link/light assembly onto camera shoe, secure by tightening knob on Cam-link. Do not over tighten!



Handle & Stud

Code: ViP-431

Weight: 3 oz (85 g)

For hand-holding i / id & To use, attach stud to handle, mount fixture on stud securing with Stand-link knob.



For additional information

on the following products, consult product instruction sheets, relevant sections in the Lowel Catalog or visit the Stands & Mounts section of www.lowel.com: Space-clamp, Lobo, Lobo Arm, Grip, Inter-link, Screw-in Stud.



Lowel i & id-light Instructions

i & id-light for the New Professional

Use the i & id-light as a convenient, lightweight, DC powered source for a flexible key, fill or back-light that goes places that the AC cable can't. Adding accessories will extend your creative possibilities.

id-light notes:

When using the id-light, keep in mind that its lamp will shift its color temperature warmer as the light is dimmed. If you find a particular dimmer setting that you use most often, store a white balance in your camera with the light at that dimmer setting. Then use a grease pencil to place a mark on the body of the light that lines up with the white line on the dimming control. In the future, you can return to that dimmer setting quickly and have a prestored white balance for it in the camera.

Use the focusing knob to move from Spot (narrow beam) to Flood (wide beam). Its 5:1 focus ratio (when used with a i-100 lamp) means that the spot setting will be approximately 5 times as bright as the flood setting (at full brightness for id).

The i & id have a high intensity reflector & prismatic glass installed. This combination gives an even output with a fresnel like quality in the shadows, an evenly dispersed flood, and a uniform spot with significant barndoor cut. It is capable of throwing sharper shadows when used on its own. Add a diffusion glass swing-in accessory, diffusion gel with a gel-frame, or attach an umbrella to create a softer source.

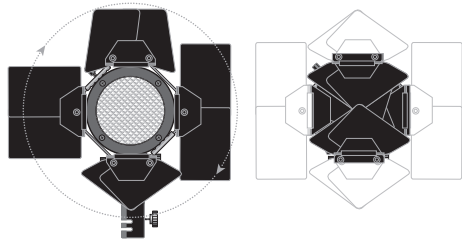

Use the rotating barndoors to trim unwanted output spill, (for example: to reduce risk of shadow in your shot caused by use of overhead boom microphones). Flexi-shafts & Tota-flags can also be attached for increased light control options.

Because the i & id-lights are tungsten-halogen sources, their color temperature will be approx 3200°K (at full brightness for id). To use the light in locations where its output will mix with daylight (5600–6500°K), its color temperature can be converted by attaching a Dichroic Filter swing-in accessory, or adding day blue gels to the Pro & i gel-frame. Both will give more realistic daylight white-balancing in video or film. Using gels will give more versatility since they are available in 1/2 & 1/4 strengths of full blue. *Note: adding day blue gels or dichroic filters will reduce output.*

Swap the Prismatic Glass to Clear Safety Glass for non-focusing higher output Super-Spot. This can be useful when lighting a small area from a greater distance, where higher output is needed. For faster switching on location, try using Clear Safety Glass in the front housing & placing the Prismatic Glass in a swing in accessory holder. Use the light for normal focusing with the accessory swung in, and then swing it out the way for quick switch to super spot.

For more reduced spill, consider adding a Snoot.

Other front accessories can help vary the quality of the light output. For example, the rotating half-scrim can allow you to reduce light output on a close subject while still illuminating subjects further away with full output. The full scrim reduces output without the use of a dimmer which can shift the color temperature warmer as the lamp is dimmed.

The oversimplified diagram below shows some of the ramifications of positioning lights for different subject types & lighting effects. This diagram is only useful as a starting point for new pros. All subjects & scenes are different and make different demands upon lighting. The height of the lights & camera, and the subjects angles & reflectivity must be considered.

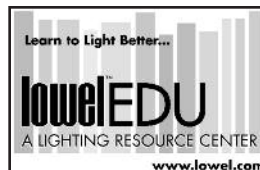

Note: in stationary use with battery belt, placing belt around stand bottom adds ballast to help prevent accidental tip-over.

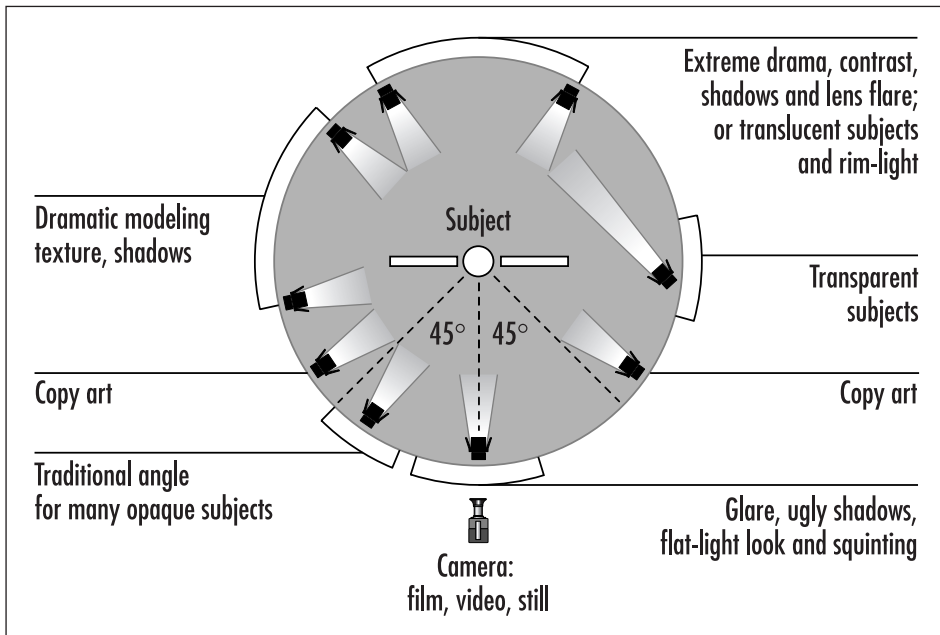

Dealers, Repairs, etc.

Lowel equipment and kits are sold through authorized Lowel Dealers and, in some countries, Authorized Lowel Distributors. Repairs, problems, suggestions, and requests for brochures, instructions, parts lists may be handled by your authorized Lowel Dealer (Distributor) or directly with Lowel. Electrical repairs should be made only by Lowel or a qualified electrician. Lowel VIP System, Lowel V-light, and Lowel Pro-light are trademarks of Lowel-Light Manufacturing, Inc. Patent Nos. 4777566, 4322779, 0011772 (Europe), 1292007 (Japan).

Ver. 2.2 © 2010 Lowel-Light Mfg, Inc. 910

Lowel-Light Manufacturing, Inc.

90 Oser Avenue, Hauppauge, NY 11788
Call: 800 645-2522 or 631 273-2500
e-mail: info@lowel.com
www.lowel.com

