

General Warnings

The Lowel Rifa-lite is a professional lighting instrument. Read these instructions and lamp manufacturer's warnings carefully before operating.

- **Do not pull power cable** to open fixture.
- **Always operate with diffuser safety panel in place.**
- **Not for household use,** use only for photographic lighting (film; video; imaging) purposes.
- **Do not leave Rifa-lite unattended.**
- **Allow unit to cool for 5 minutes** before storing.
- **Do not use more than one diffuser,** nor any diffuser other than the Lowel Rifa-lite diffuser supplied.
- **Make certain that lamp voltage matches power source voltage.** The units use lamps of different voltages (example: never connect a 120 volt lamp to a 230 volt source, or a Rifa-44 with 12 or 30 volt lamp to any higher voltage).

■ **Do not exceed maximum rated wattage for unit.**

■ **Make certain to attach appropriate approved power cable for voltage being used.**

■ **Do not interfere with unit's ventilation.**

■ **Never touch hot parts.**

■ **Units such as this emit considerable light and heat,** if not properly used could be dangerous.

■ **Avoid placing unit too close** to faces, delicate objects or flammable materials.

■ **Do not use near standing water or in damp locations.**

■ **When mounting light overhead** use Safety Cables.

■ **Unplug before cleaning** material. Handle reflector with care. Clean with a damp cloth only, as soap or chemical cleaners may damage material. Do not operate while fixture is damp.

Lamp Warnings

- **Always unplug unit before** lamping.
- **Avoid touching glass** with bare fingers. Insert lamps carefully to avoid breaking. Lamps must be pressed firmly and fully into socket. Not doing so will cause socket damage and shortened lamp life.
- **Never exceed maximum rated wattage of unit.**
- **LC-44 socket is designed** to accept lamps with 2 different pin configurations. use extra caution when installing & removing lamps.

Rifa-lite® 44

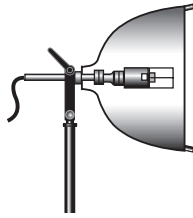

Code: LC-44
Front size: 16 x 16" (40 x 40 cm)
Collapsed length: 21" (53 cm)
Max. wattage: 300
Max. amperage: 2.5 at 120v
Weight: 2.1 lbs (1 kg)
 w/ 4' captive cable
U.S. Patent: 459645

Rifa-lite® 55

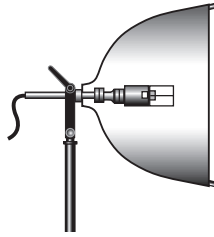

Code: LC-55
Front size: 21 x 21" (53 x 53 cm)
Collapsed length: 24" (61 cm)
Max. wattage: 500
Max. amperage: 4.2 at 120v
Weight: 2.5 lbs (1.1 kg)
 w/ 4' captive cable
U.S. Patent: 459645

Rifa-lite® 66

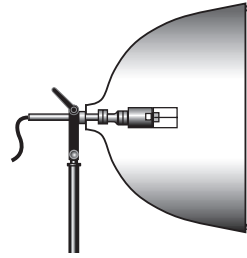

Code: LC-66
Front size: 25 x 25"
 (63.5 x 63.5 cm)
Collapsed length: 30" (76 cm)
Max. wattage: 750
Max. amperage: 6.25 at 120v
Weight: 3.5 lbs (1.6 kg)
 w/ 4' captive cable
U.S. Patent: 459645

Lowel Rifa-lite Models

Rifa-lite® 88

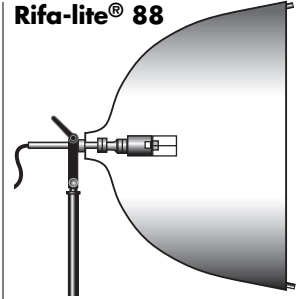

Code: LC-88
Front size: 32 x 32" (81 x 81 cm)
Collapsed length: 34" (86 cm)
Max. wattage: 1000
Max. amperage: 8.3 at 120v
Weight: 4.5 lbs (2 kg)
 w/ 4' capt. cable
U.S. Patent: 459645

Beam angles — points at which intensity drops to 50% of maximum

Performance with Recommended Lamps

LC-44

with 120v, 250w, 3200°K, GCA lamp

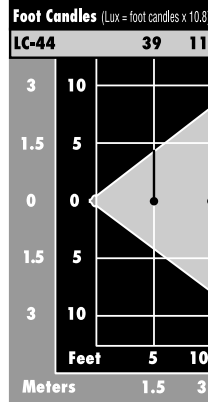

LC-55

with 120v, 500w, 3200°K, EHC lamp

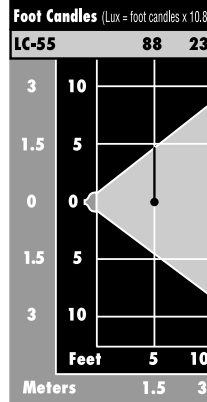

LC-66

with 120v, 750w, 3200°K, EHF lamp

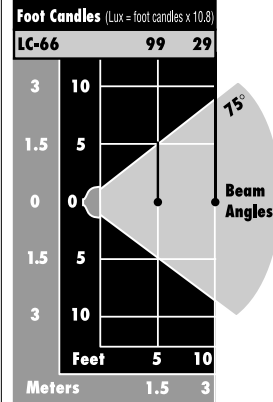

LC-88

with 120v, 1000w, 3200°K, FEL lamp

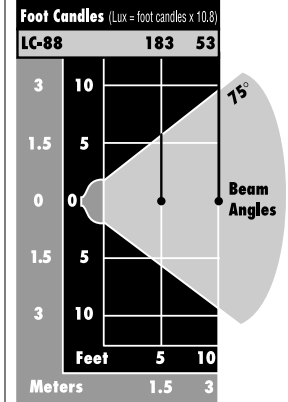

Lamp Code	Volts	Watts	°K	Avg Life	FC(lux)5'	FC(lux)10'
LC-44 – Maximum 300w						
JCV14.5-50WC	12/14	50	3200	100 hr	7 (78)	2 (21)
GCC	12	100	3200	100 hr	10 (103)	3 (28)
GCB	30	200	3200	100 hr	26 (280)	7 (74)
FSH	120	125	3200	100 hr	15 (162)	4 (44)
FVM	120	105	3200	250 hr	16 (170)	5 (48)
FVL	120	200	3200	200 hr	30 (320)	9 (92)
GCA	120	250	3200	100 hr	39 (420)	11 (120)
CP/96*	120	300	3400	75 hr	50 (540)	14 (147)
GLF/P44	230	235	3200	100 hr	32 (345)	9 (94)
CP/97*	230	300	3200	75 hr	46 (495)	12 (132)

*Different lamp base, Rifa-44 socket accepts this base.



Lamp/Beam Data

Lamp Code	Volts	Watts	°K	Avg Life	FC(lux)5'	FC(lux)10'
LC-55 – Maximum 500w						
EHC	120	500	3200	300 hr	88 (950)	23 (248)
EHD	120	500	3000	2000 hr	67 (724)	18 (194)
JCV 220V-500WBM	220	500	3000	2000 hr	68 (730)	18 (196)
JCV 240V-500WBM	240	500	3000	2000 hr	63 (680)	17 (185)
LC-66 – Maximum 750w (May also use lamps for LC-55)						
EHF	120	750	3200	300 hr	99 (1069)	29 (313)
EHG	120	750	3000	2000 hr	80 (864)	22 (238)
FKR/230	230	650	3200	300 hr	82 (886)	23 (248)
LC-88 – Maximum 1000w (May also use lamps for LC-66)						
FEL	120	1000	3200	300 hr	183 (1976)	53 (572)
FEP/220	220	1000	3200	150 hr	156 (1685)	46 (497)
FEP/240	240	1000	3200	150 hr	148 (1598)	40 (432)



Lowel Rifa-lite® Instructions

Setup Warning



Warning: Do not pull power cable to open light. Doing so may damage the cable & fixture. Make sure fixture is unplugged before assembly.

Rifa Mount

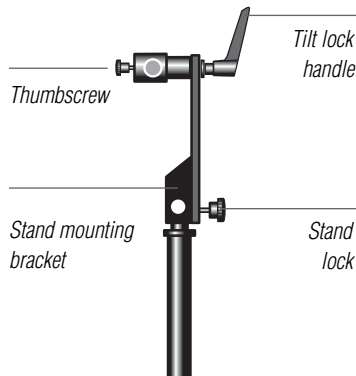

Opening Rifa

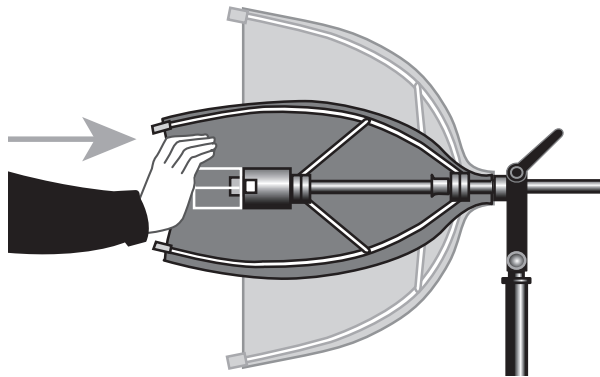

Setting Up Rifa-lite (all models)



- 1 ■ Remove the Rifa-lite unit from its sleeve and mount and lock on suitable stand.
- Release tilt lock handle, tilt light to horizontal, relock tilt handle, release the Velcro strap around the folded assembly.
- Reaffix the strap to itself. Unfurl Rifa-lite reflector material until assembly loosens.

- 2 ■ Loosen thumbscrew located on back end of fixture.
 - While holding the assembly base push the socket/lamp cage assembly (avoid touching lamp) inward until the assembly "click-locks" into position.
 - Tighten thumbscrew clockwise to lock fixture open.
- Warning:** The fixture must be locked open before using, failure to do so may cause the fixture to close during operation damaging the fixture.
- Place on stand with one leg extending straight out under Rifa for best balance.
 - For increased balance, use Rifa Balance Bar Accessory

- 4 ■ Attach diffuser panel by placing it over the front of the light inserting the corner pins of the reflector frame through the grommets of the diffuser, securing it with Velcro strips located around the reflector.
 - Never use more than one diffuser at a time.
- Always operate Rifa-lite with diffuser panel in place.**
- Attach 16' extending (switched) power cord to captive cable IEC connector.

Attaching Fabric Egg Crates

The Fabric Egg Crates are a valuable accessory for controlling the light spill of the Rifa. They can also help prevent a moving subject from becoming overlit as they approach the light. Egg Crates are available in 3 different dispersion angles (30, 40 & 50 degree) for each model of Rifa.

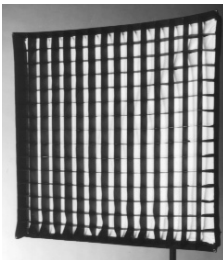

- Unfold Egg Crate accessory. With the diffuser already attached, place the Fabric Egg Crate over the front of the light, inserting the corner pins of the reflector frame into the metal tube sockets located in the egg crate corners.



- Secure the egg crate to the body of the Rifa with Velcro strips located around the edge of the reflector housing.

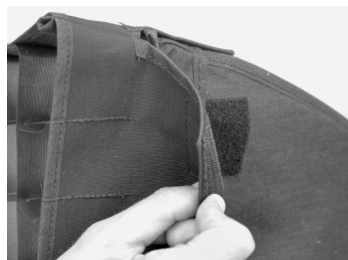

Storage

Unplug light and allow to cool for at least five minutes before disassembly.

- Detach fabric accessory (if used) and front diffuser. To prevent damage to the diffuser, wrap material around tube and place in pocket of light storage sleeve.
- Hold stand mounting bracket, loosen thumbscrew on mounting arm assembly and push shaft until frame has collapsed.
- Smooth reflector material and secure with Velcro strap, tilt light down, remove unit from light stand and place in sleeve.

Rifa-lite Beam Angles

Rifa-lite alone - 75°

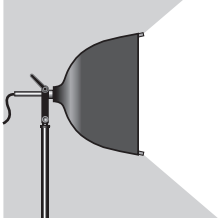

Rifa-lite with 50° Egg Crate

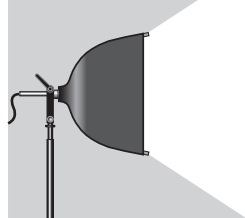

Rifa-lite with 40° Egg Crate

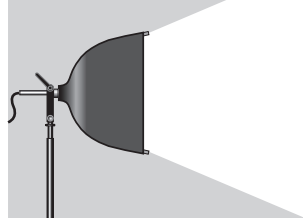

Rifa-lite with 30° Egg Crate

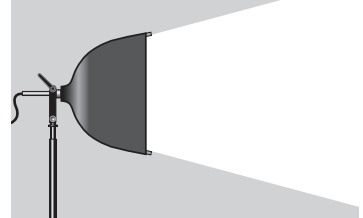

An Introduction to Rifa-lite for the New Pro

The Rifa is a dedicated soft light, with quick set-up and beautiful output. With a little practice, good results are easy to achieve.

First, a brief overview...

Soft light is soft because the size of its source is large when compared to the size of the subject being lit. The larger the ratio of light source size to subject size, the softer the light. If you stand outside on an overcast day, you will have very little shadow because the size of the source (the whole sky) is so much larger than you are.

Hard light is hard because the size of its source is small when compared to the subject being lit. In a fixture such as a Pro-light, the physical size of the source is much smaller. This makes the light very directional and as a result, the shadows it throws are sharper. A clear sunny day will result in sharper shadows because of the smaller (harder) source.

Distance from source to object becomes a factor in sharpness as well. The further away from the subject the source is, the smaller the source appears to be & therefore the harder its shadows.

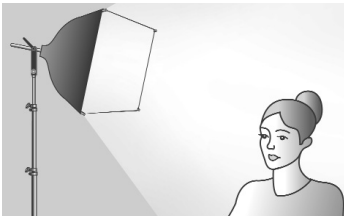

Soft source close = Softest shadow



Same soft source further back = Less soft shadow

Directional Sources have smaller surfaces



Direct (small) source = Hardest shadows

Rifa Models

There are 4 models of Rifa, with front diffusers in sizes of

- 16 x 16" (Rifa 44)
- 21 x 21" (Rifa 55)
- 25 x 25" (Rifa 66)
- 32 x 32" (Rifa 88)

So logically, at same distance, the 88 will be softest of all because its source (the lit diffuser) is the largest.

Rifa's 55, 66, & 88 all use the same socket.

And while you should never use higher wattage lamps than the maximum recommended for each model, you can use lower wattage lamps in the larger models for increased softness at the same wattage / output.

For example, using the 500 watt EHC lamp in the Rifa 55 at a distance of 5 feet will give you 88 foot candles of light with the amount of softness from a 24 square inch source, yet using the same 500 watt EHC lamp in the Rifa 88 from a distance of 5 feet, will give you the approx. the same 88 foot candles of light, yet a greater amount of softness because its now coming from a larger 32 square inch source.

Positioning the Rifa

Soft light falls off in output strength much more quickly than a hard source of identical wattage, because the soft source is so much larger in size (light is dispersed in a wider direction). As a result, soft sources, like Rifa are designed to be used fairly close to the subject. This can create problems of light spill on the areas behind the subject. The first step in

minimizing background spill is to move the subject away from walls, by 6 feet or so if possible. This will allow a light placed on a stand higher than the subject to fall off towards the floor, before hitting the wall.

Using Fabric Egg Crates

Another situation that can arise as a result of using soft sources close to the subject is fluctuation in exposure level that can occur if the subject moves back & forth in relation to the light source. With the source being so close, its effect can be noticeable in the camera. An easy solution to this, which can also help reduce the light spill described previously, is to add an accessory fabric egg crate to the front of the light. Fabric egg crates are available in different degrees of dispersion, so where the Rifas have an output that will cast light in almost 180 degrees (with the strongest portion of the output will being in the center 70- 75 degrees), the egg crates will trim this to either 30, 40 or 50 degrees, depending on the model of egg crate used. They do a great job of preventing the subject from "burning up" if they happen to get too close to the light source for your exposure.

Mixing with daylight

For setups when you are shooting in a room that also has windows, where the desire is to mix the output of the Rifa with daylight, some level of color correction gel will be needed. The goal is to match the warmer 3200k tungsten lamp in the Rifa, with the cooler daylight color (5000-6500k). Because daylight can vary in color, depending on whether its direct sun, overcast clouds, blue sky or any combination

of the above, you will need to choose either 1/4, 1/2 or full day blue to most closely match the Rifa to the daylight in the room. Rifa Day Blue Gels are custom cut to fit the Rifas. They are sized to cover the front diffuser with enough excess to allow them to be clipped to the velcro pockets on the side of the light. You can use clothespins, Lowel Gel-jawz, or any small spring loaded clip.



These are just some starting suggestions.

For additional introductory information, see the Resources section of the complete Lowel catalog. For an in-depth understanding of the creative decisions involved in the art of lighting, we suggest Ross Lowell's acclaimed book, Matters of Light & Depth, available from many of our dealers.

Also see the evolving educational resource section of www.lowel.com

Basic Starter Setups using Rifa-lite

Setup 1

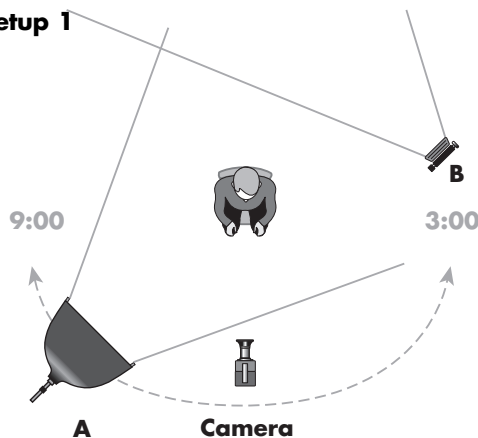

1 Rifa-lite, 1 Tota-light

To light an interview subject with the Rifa-lite alone, You can place the light at a 45° angle, 2-3 feet higher than the subject, with the light tilted down towards the subject. From there, you can arc the angle of the Rifa-lite out in either direction from 6:00 (at camera - this will give the most even lighting) to either 3:00 or 9:00, depending on how much dramatic contrast & fall off you want in your shot. Place the broad throw Tota to light the background without spilling onto the subject.

Setup 2

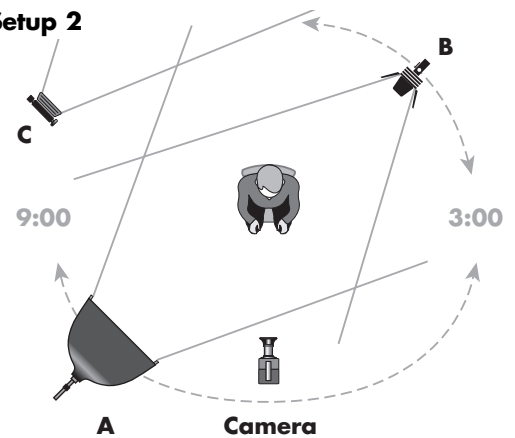

1 Rifa-lite, 1 Pro-light, 1 Tota-light

To light an interview subject with 1 Rifa-lite and 1 Pro-light (250w focusable hard source), try using the Pro-light as a back light to give the subject separation from the background. Vary the angle to the subject while keeping the 2 lights facing each other for increased dramatic results. As you approach a 9:00 / 3:00 placement, the Pro becomes a hard / dramatic key, as the Rifa becomes soft fill. Note: watch for lens flare from the back light (Pro). Place the broad throw Tota so it lights the background without spilling onto the subject.

Setup Keys: A Rifa with 250 - 500W lamp B Pro-light with 100 - 250W lamp C Tota-light with 300 - 500W lamp

Light Controls

Replacement Diffusers

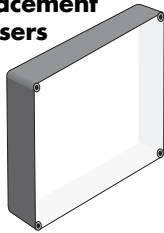

Standard light diffuser replacements for all 3 models of Rifa-lite. Diffuser must always be used to protect against lamp explosion.

For LC-44

Code: LC-44D

Size: 16 x 16" (40 x 40 cm)

For LC-55

Code: LC-55D

Size: 21 x 21" (53.3 x 53.3 cm)

For LC-66

Code: LC-66D

Size: 25 x 25" (66 x 66 cm)

For LC-88

Code: LC-88D

Size: 32 x 32" (81.3 x 81.3 cm)

Rifa Daylight Gel Sets

For correcting Rifas to mix with varying strengths of daylight, they attach to Rifa's velcro pockets with clothespins.

Each set contains 3 sheets: Day Blue; 1/2 Blue; & 1/4 Blue (1 sheet each).

For LC-44

Code: LC-47

Size: 23 x 16" (58.4 x 40.6 cm)

For LC-55

Code: LC-57

Size: 29 x 22" (73.7 x 56 cm)

For LC-66

Code: LC-67

Size: 33 x 26" (84 x 66 cm)

For LC-88

Code: LC-87

Size: 39 x 32" (99 x 81.3 cm)

Fabric Egg Crates

For better light control. Each Egg Crate attaches quickly and afterwards folds up to be stored in its own small light-weight bag.

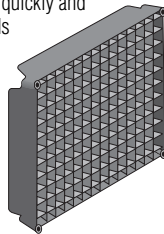

30° x 30° Egg Crate

Fabric Egg Crate with 30° dispersion angle.

30° Egg Crate for LC-44

Code: LC-44EC/30

Weight: 8 oz (228 g)

30° Egg Crate for LC-55

Code: LC-55EC/30

Weight: 9.5 oz (266 g)

30° Egg Crate for LC-66

Code: LC-66EC/30

Weight: 12.5 oz (345 g)

30° Egg Crate for LC-88

Code: LC-88EC/30

Weight: 1 lb (448 g)

40° x 40° Egg Crate

Fabric Egg Crate with 40° dispersion angle.

40° Egg Crate for LC-44

Code: LC-44EC/40

40° Egg Crate for LC-55

Code: LC-55EC/40

40° Egg Crate for LC-66

Code: LC-66EC/40

40° Egg Crate for LC-88

Code: LC-88EC/40

50° x 50° Egg Crate

Fabric Egg Crate with 50° dispersion angle.

50° Egg Crate for LC-44

Code: LC-44EC/50

50° Egg Crate for LC-55

Code: LC-55EC/50

50° Egg Crate for LC-66

Code: LC-66EC/50

50° Egg Crate for LC-88

Code: LC-88EC/50

Mounts

Uni TO Stand

Code: UN-55

Weight: 2.6 lbs (1.2 kg)

Size: 21.5" (55.2 cm) folded.

Maximum height: 7' (2.2 m)

Base diameter: 46"

New stand, based on design combination of Uni-stand & Omni-stand. More stable than Uni-stand, more compact than Omni-stand. For Rifa 44.

KS Jr. Stand

Code: DT-33

Size: Maximum height: 7'7" (2.3 m)

Collapsed length: 2'3" (65 cm)

Weight: 3.5 lbs (1.6 kg)

Wide based, sturdy, lightweight stand with 5/8" (1.59 cm) stud and solid bar legs. For Rifa 44, 55, 66.

KS Stand

Code: KS

Size: Maximum height:

9' (2.74 m),

Collapsed length:

3' (91 cm)

Weight:

4 lbs (1.8 kg)

Wide based, sturdier, lightweight stand with 5/8" (1.59 cm) stud. For all 4 Rifas.

KSA Stand

Code: KSA

Black-anodized, air-cushioned stand. Otherwise same as above.

Tota-clamp

Code: T1-30

Weight: 4 oz (113 g)

Clamps onto pipes, shelves, etc. up to 1 7/8" (4.78 cm) thick.

5/8" (1.59 cm) stud locks in two positions and accepts a light. Also accepts two Flexi-shafts with flags or flectors.

Safety Cable (3)

Code: CM-50

Weight: 2 oz (57 g)

Recommended for extra security when attaching Rifa-lites overhead. (Set of 3).

Balance Bar

Code: LC-30

Size: 12.5" (31.8 cm)

Weight: 6.5 oz (184 g)

The Rifa Balance Bar is an extension arm accessory that mounts between the Rifa-lite and its stand fitting. When installed, it can shift the Rifa's center of gravity to allow better stand balance. It can facilitate angling and tilting of the light when necessary, such as on a boom arm, without the need to overtighten stand fitting knob. Install Balance Bar as shown, orienting conical washers as shown (*).

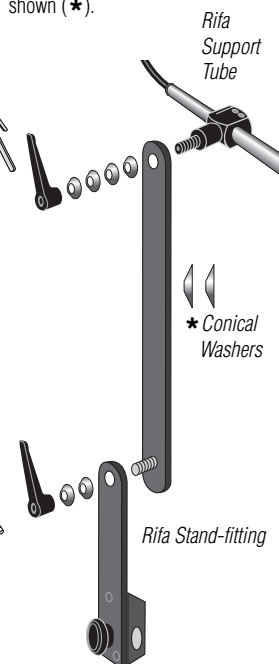

Cables

16' Switched AC Cable

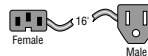

Code: T1-80

Weight: 13 oz (369 g)

Standard #18/3; with switch.

10' Unswitched Cable

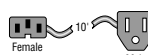

Code: T1-808

Weight: 1.1 lbs (.5 kg)

For portable stage lighting use. "Hard service" #18/3 cable.

16' (5 m) Eurocord

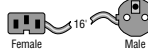

Code: T1-801

Weight: 13 oz (369 g)

#18/3 (.75 mm/3) with double pole switch and male CEE-7 plug.

16' (5 m) T/O UK Cord

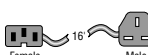

Code: T1-802

Weight: 13 oz (369 g)

#18/3 (.75 mm/3) with double pole switch and male fused BS 1363A plug.

5' Omni 30v Cable



Code: O1-81

Adapts Rifa-44 for use with 30 volt battery #18/3; with switch and 2 pin "Amphenol Type" connector for batteries.

4-pin XLR Switched Cable

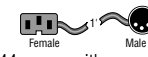

Code: R2-82

Adapts the Rifa-44 or use with appropriate 12 volt batteries. No wiring required.

1' 12v Switched Cigarette Lighter/Car Adaptor Cable



Code: R2-85

Adapts Rifa 44 IEC Connector for use with some 12 volt batteries and automobile cigarette lighter sockets. No wiring required.

12v Car Adaptor



Code: O1-82

Connects T1-80 Cable to cigarette lighter connector. For Rifa 44 only.

Lowel-Light Manufacturing, Inc.



140 58th Street Brooklyn, NY 11220
Call: 800 334-3426 or 718 921-0600
Fax: 718 921-0303
e-mail: info@lowel.com
www.lowel.com

Problems, info, repairs, etc.

Lowel equipment and kits are sold through authorized Lowel Dealers and, in some countries, Authorized Lowel Distributors. Repairs, problems, suggestions, and requests for brochures, instructions, parts lists may be handled by your authorized Lowel Dealer (Distributor) or directly with Lowel. Electrical repairs should be made only by Lowel or a qualified electrician. Rifa-lite® is a registered trademark of Lowel-Light Manufacturing, Inc. U.S. Patent No. 4594645, ver: 5.0 © Lowel-Light Mfg., Inc. 2005