

Warnings

The L-light is a professional lighting instrument. Read these instructions and lamp manufacturer's warnings carefully before operating.

- The unit uses lamps of different voltages. Make certain that lamp voltage matches power source voltage.
- Do not interfere with the unit's ventilation by covering it in any way.
- Always unplug unit before relamping. Never touch hot metal parts with bare hands. Avoid aiming the light at or placing it too close to faces, delicate objects or flammable materials.
- Do not use light near standing water.
- Turn the unit off after use and allow it to cool before storing.

Lamp Information

Do not exceed lamp wattages of 300. The L-light uses medium screw base (E26) reflector lamps of various sizes (R14, R20, R25, R30, R40) and wattages, as well as the recommended medium screw base 120v MR-16-type lamps. Other types of medium screw base lamps can also be accommodated, such as some self-ballasted compact fluorescents. If the lamp is too large to fit the housing, the unit's rotating baffle assembly can be removed by unscrewing the nut on the rear of the unit. However, this precludes the option of using many of the L-light's accessories, such as Clip-on Barndoors, accessory holders, etc.

MR-16 Halogen Lamps

Medium base, screw in, wide angle flood and narrow-angle spot lamps. 120v, 100w, 3000°K, 2000 hrs.

MR-16 lamps must always be used with an MR-16 glass accessory.

100w Flood

Code: L1-100F

F.C. at 10' = 25

Beam Angle = 40°

100w Spot

Code: L1-100S

F.C. at 10' = 28

Beam Angle = 13°

Cable

The L-light is supplied with a captive #18/3 cable with male IEC connector, and a 16' #18/3 switched AC cable. The AC cable should not be used with non-Lowel equipment.



L-light Mounting

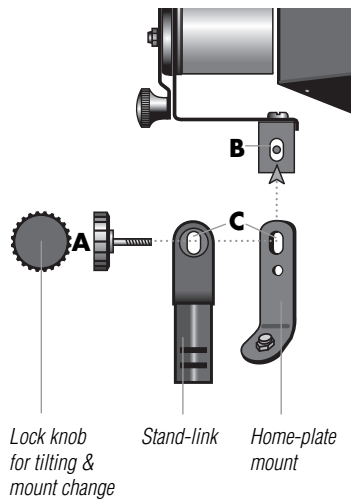

Lock knob for tilting & mount change

Stand-link

Home-plate mount

L-light with Stand-link

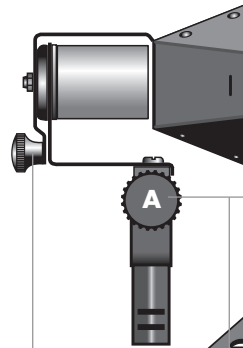

Rotating shield for clip-on barndoors

L-light with Home-plate™

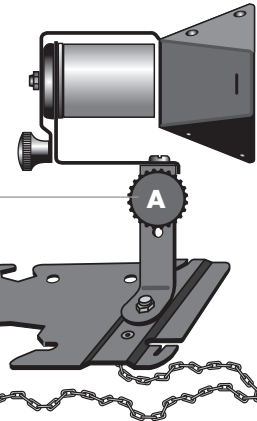

Lock knob for tilting & mount change

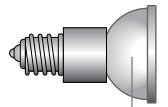

Screw-thread MR-16 lamp

Mounting L-light with Stand-link or Home-plate

- Remove the large Lock Knob **A** completely.
- Line straight sections **B** of screw carefully with cut-out **C** in Stand-link or Home-plate.
- Tighten knob securely.



L-light with Home-plate



The Home-plate allows the mounting of L-lights on floors and other horizontal surfaces, on pipes and stand shafts, behind moldings, and, with Lowel Gaffer-tape, to windows and some vertical surfaces. Always position Home-plate with the large & small mounting notches on top and chain lock slots on the bottom.

The mounting chain lock slot is for creating a spring tension with the attached chain, to hold the Home-plate firmly in place on pipe or stand shaft. For mounting on stands, pipes, etc., up to 1-3/4" in diameter: use large mounting notch and the chain slot (on the opposite side of the plate.) Place large notch around stand, bring end of chain behind the stand, and spring end of plate down 1/2" toward the stand. Pull chain taut and slip into chain lock slot, to maintain tension. For mounting on smaller stands, pipes, etc., up to 1/2" in diameter: follow directions above using smaller mounting notch.

For larger stands, 2x4's, or pipes up to 4" in diameter: invert Home-plate and press flat against surface of pipe. Pull chain taut behind pipe and slip into chain lock slot.

Mounting Home-plate with Gaffer-tape

Surfaces must be free of dust, grease and moisture. Always position Home-plate with large & small notches on top. Use two 12" strips of Lowel Gaffer-tape and burnish down firmly with coin or fingernail. Half of tape should extend above plate. For rough walls or when installing lights for long duration, longer strips of tape should be used. To reinforce, place one strip of tape horizontally across top of Home-plate and over the two vertical strips (as shown).

CAUTION: To avoid marring of mounting surfaces, do not tape to wallpaper, soft-composition board, or paint that is not well-bonded. Never tape to ceilings or aim lamp directly at tape. Remove Gaffer-tape by pulling it back diagonally. Never pull plate away from wall without first removing tape.

Other mounting methods

Either mounting notches alone can sometimes be used to attach the light onto the top of doors, on door knobs or hinges and air duct louvers and behind some moldings.

The plate supports and balances the L-light on horizontal surfaces, but will be more stable when secured with Gaffer-tape. The holes in the plate (see illus) can be used to mount the unit with nails or screws on appropriate surfaces. Four units can be bolted together through one of these holes on each plate to form a quad light.

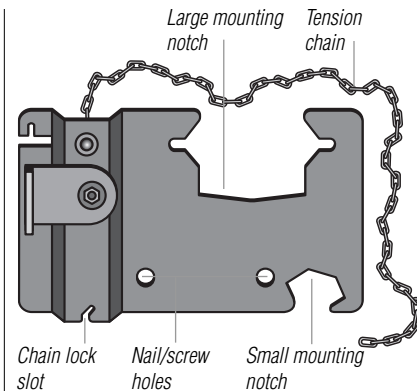

Chain lock slot

Nail/screw holes

Small mounting notch

Other Lowel mounting devices, such as the Screw-in Stud, Stud-link, Tota-clamp, Tota-mount, Space-clamp, Lobo with Lobo Arm, Scissor-mount and Grid-lock, can be used to mount the L-light when the Stand-link is attached. Consult individual product instruction sheets.

MOUNTING CAUTION: To ensure safety, always test for secure mounting by pulling downward on light or plate.

Storing

Except for screw-base MR-16 lamps, the L-light should not be stored with lamps in socket. When storing L-light with MR-16, remove Gel-jawz and close barndoors over lamp. If storing L-light attached to Home-plate, remove lamp and tilt socket down onto plate.

WARNING: Wait for lamp to cool before storage.



Lowel L-light Instructions

Light Control Accessories

Clip-on Barndoors

Attach Clip-on Barndoor Frame (with or without first attaching Clip-on Barndoor Leaves) to unit by snapping clips into notches on sides of L-light baffle assembly. Up to four Clip-on Barndoor Leaves can be attached by snapping dual clips of each Clip-leaf onto frame. Clip-on Barndoor assembly can be used with screw-base MR-16s and other reflector lamps no larger than R-20s.

4-way Clip-on Barndoor Code: L1-20

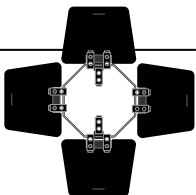

2-way Clip-on Barndoor Code: L1-25

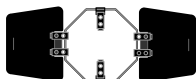

Clip-on Barndoor Frame (no leaves) Code: L1-21



Clip-leaf (only) Code: IP-24



MR-16 Clip-on Accessory Holder



Snap MR-16 Clip-on Accessory Holder with glass accessory directly onto the rim of screw-base MR-16 halogen lamp. Should the glass accessory require replacement, insert glass part behind snap-in springs of holder after depressing the springs.

Clear Glass in Holder Code: L1-52H

Attaches to rim of halogen MR-16 lamps. Absorbs some U.V. with 5% light loss.

Diffused Glass in Holder Code: L1-50H

Attaches to rim of halogen MR-16 lamps. Softens light; reduces intensity and contrast. Light loss: approx. 50%.

Dichroic Filter in Holder Code: L1-51H

Attaches to rim of halogen MR-16 lamps. Converts tungsten to approx. average daylight. Light loss: approx. one stop.



www.lowel.com



Swing-in Accessory Holder

For use with R-20 and smaller lamps, including screw-base MR-16s. Attach Clip-on Barndoor Frame to unit. Press both sides of captive retaining spring clip on Holder in toward center to release. Slide Swing-in Accessory (diffused glass or dichroic filter) into place. Resecure retaining spring to hold Accessory in place. Swivel the lock fastener on Accessory Holder 180°. Align Holder in center of one of the eight sides of the Frame and hold firmly in place while turning fastener 180° to lock. Swing Accessory Holder over lamp and snap into place on opposite Frame side. Swing out when not in use. Note: Only two Clip-on Barndoors can be accommodated on Frame when using Swing-in Accessory Holder.



Diffused Glass w/Swing-in Holder Code: iP-50H

Softens light, reduces intensity. Light loss: approx. 50%.

Dichroic Filter w/Swing-in Holder Code: iP-51H

Converts tungsten to approx. average daylight. Light loss: approx. one stop.

Mounts

Uni-stand

Code: UN-33
Size: 21.5" (54.6 cm) folded
Extends to 7'11".

All aluminum stand, wide base, legs can lie flat to floor, large locking knobs. Folds compactly to fit in smaller kits.

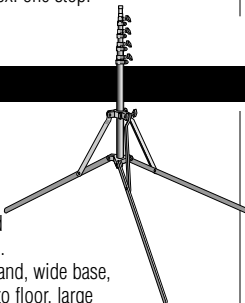

Stand-link

Code: ViP-39

Rugged metal Stand-link mounts L-light on 5/8" and smaller studs on stands, clamps, handles and Scissor-mounts. Supplied with L2-10.

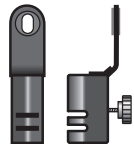

Gels and Gel-jawz

Pre-cut 6 x 6" gels are available for use with the L-light. They can be used with the Pro & i Gel Frame or clipped directly onto barndoor leaves with Gel-jawz.

WARNING: Do not double up gels, as heat build-up between them will be too great.

To attach gels, snap Gel-jawz into indents on barndoors. Make sure silver metal portion of Gel-jawz is on underside of barndoor or clip will not fasten properly. Fasten 6 x 6" gel with Gel-jawz clips.

IMPORTANT When using lamps larger than R-20s, use Tota-gels with Tota-frame or cut larger gels out of a gel sheet. Make sure to put a generous curve in the gel sheet to keep gel safely away from lamp.

Gel-jawz (8) Code: CL-15

Package of eight clips.

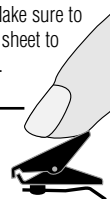

Pro & i Gel Frame

Code: iP-40

Holds 5 x 6" gels. Collapses for storage.

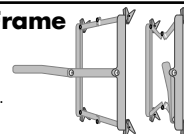

Pro & i Gels (5)

Size: 5 x 6" (12.52 x 15.25 cm) sheets
(Pkg of 5) Blue Frost (iP-69); Day Blue (iP-70); ND 3 (iP-71); Frost (iP-72); Assorted—3 Day Blue, 1 Frost, 1 ND 3 (iP-78).

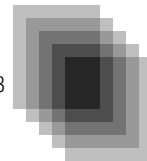

L-light with Tota-brella

(for fill and soft light)

Slide shaft of Tota-brella into L-light mounting block after loosening knob. Tighten knob to secure. Umbrella shaft may obstruct movement when the light is used with larger lamps, e.g. R-40s.

Tota-brella Standard/Silver

Code: T1-25

Size: 27" (68.6 cm) open, 19" (48.3 cm) closed. Slips into L-light mounting bracket to create a softlight.

Special/White

Code: T1-26

Same as above with extremely soft, white reflective surface.



MR-16 Clip-on Accessory Holder



Snap MR-16 Clip-on Accessory Holder with glass accessory directly onto the rim of screw-base MR-16 halogen lamp. Should the glass accessory require replacement, insert glass part behind snap-in springs of holder after depressing the springs.

Clear Glass in Holder Code: L1-52H

Attaches to rim of halogen MR-16 lamps. Absorbs some U.V. with 5% light loss.

Diffused Glass in Holder Code: L1-50H

Attaches to rim of halogen MR-16 lamps. Softens light; reduces intensity and contrast. Light loss: approx. 50%.

Dichroic Filter in Holder Code: L1-51H

Attaches to rim of halogen MR-16 lamps. Converts tungsten to approx. average daylight. Light loss: approx. one stop.



www.lowel.com



Mounts

Uni-stand

Code: UN-33
Size: 21.5" (54.6 cm) folded
Extends to 7'11".

All aluminum stand, wide base, legs can lie flat to floor, large locking knobs. Folds compactly to fit in smaller kits.

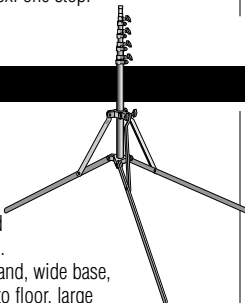

Stand-link

Code: ViP-39

Rugged metal Stand-link mounts L-light on 5/8" and smaller studs on stands, clamps, handles and Scissor-mounts. Supplied with L2-10.

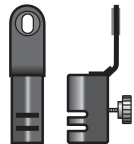

Home-plate™

Code: L1-32

Balances L-light (and ViP lights) on floors and other surfaces; mounts L-light on pipes and stands, behind moldings and, with Lowel Gaffer-tape, to windows and some walls. Supplied with L2-15.

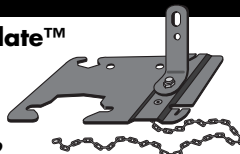

Tota-clamp

Code: T1-30

Clamps onto pipes and objects up to 1 7/8" (4.8 cm) thick. 5/8" (1.59 cm) stud locks in two positions and accepts a light. Two Flexi-shafts with Tota-flags can be attached.



Small Spring Clamp w/Stud

Code: ML-12

5/8" stud mounted versatile spring clamps.

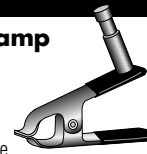

Large Spring Clamp w/Stud Code: ML-13

Repairs & Info

Repairs, problems, suggestions and requests for brochures/catalogs, instructions and parts lists can be handled through your Authorized Lowel Dealer/Distributor or directly through Lowel. Electrical repairs should be made only by Lowel or by a qualified electrician.

Using the L-light

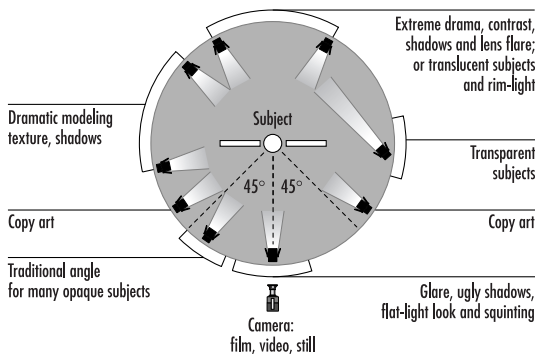

With a variety of mounting & accessory options the Lowel L-light is a versatile easy to hide accent light, a quick kicker, a discreet backlight or, with diffusion, a subtle fill. The chart below can be useful when considering placement options for the light.

Lowel-Light Mfg., Inc.

90 Oser Avenue, Hauppauge N.Y. 11788
Call: 800 645-2522 or 631 273-2500
Fax: 631-273-2557
e-mail: info@lowel.com
www.lowel.com

