

# MR10Smk3

*Powered Studio Subwoofer*

**OWNER'S MANUAL**



# Important Safety Instructions

1. Read these instructions.
2. Keep these instructions.
3. Heed all warnings.
4. Follow all instructions.
5. Do not use this apparatus near water.
6. Clean only with a dry cloth.
7. Do not block any ventilation openings. Install in accordance with the manufacturer's instructions.
8. Do not install near any heat sources such as radiators, heat registers, stoves, or other apparatus (including amplifiers) that produce heat.
9. Do not defeat the safety purpose of the polarized or grounding-type plug. A polarized plug has two blades with one wider than the other. A grounding-type plug has two blades and a third grounding prong. The wide blade or the third prong are provided for your safety. If the provided plug does not fit into your outlet, consult an electrician for replacement of the obsolete outlet.
10. Protect the power cord from being walked on or pinched particularly at plugs, convenience receptacles, and the point where they exit from the apparatus.
11. Only use attachments/accessories specified by the manufacturer.
12. Use only with a cart, stand, tripod, bracket, or table specified by the manufacturer, or sold with the apparatus. When a cart is used, use caution when moving the cart/apparatus combination to avoid injury from tip-over.
13. Unplug this apparatus during lightning storms or when unused for long periods of time.
14. Refer all servicing to qualified service personnel. Servicing is required when the apparatus has been damaged in any way, such as power-supply cord or plug is damaged, liquid has been spilled or objects have fallen into the apparatus, the apparatus has been exposed to rain or moisture, does not operate normally, or has been dropped.
15. This apparatus shall not be exposed to dripping or splashing, and no object filled with liquids, such as vases or beer glasses, shall be placed on the apparatus.
16. Do not overload wall outlets and extension cords as this can result in a risk of fire or electric shock.
17. This apparatus has been designed with Class-I construction and must be connected to a mains socket outlet with a protective earthing connection (the third grounding prong).
18. This apparatus has been equipped with a rocker-style AC mains power switch. This switch is located on the rear panel and should remain readily accessible to the user.
19. The MAINS plug or an appliance coupler is used as the disconnect device, so the disconnect device shall remain readily operable.



**20. NOTE:** This equipment has been tested and found to comply with the limits for a Class B digital device, pursuant to part 15 of the FCC Rules. These limits are designed to provide reasonable protection against harmful interference in a residential installation. This equipment generates, uses, and can radiate radio frequency energy and, if not installed and used in accordance with the instructions, may cause harmful interference to radio communications. However, there is no guarantee that interference will not occur in a particular installation. If this equipment does cause harmful interference to radio or television reception, which can be determined by turning the equipment off and on, the user is encouraged to try to correct the interference by one or more of the following measures:

- Reorient or relocate the receiving antenna.
- Increase the separation between the equipment and the receiver.
- Connect the equipment into an outlet on a circuit different from that to which the receiver is connected.
- Consult the dealer or an experienced radio/TV technician for help.

**CAUTION:** Changes or modifications to this device not expressly approved by LOUD Technologies Inc. could void the user's authority to operate the equipment under FCC rules.

**21.** This apparatus does not exceed the Class A/Class B (whichever is applicable) limits for radio noise emissions from digital apparatus as set out in the radio interference regulations of the Canadian Department of Communications.

**ATTENTION** — *Le présent appareil numérique n'émet pas de bruits radioélectriques dépassant les limites applicables aux appareils numériques de class A/de class B (selon le cas) prescrites dans le règlement sur le brouillage radioélectrique édicté par les ministere des communications du Canada.*

**22.** Exposure to extremely high noise levels may cause permanent hearing loss. Individuals vary considerably in susceptibility to noise-induced hearing loss, but nearly everyone will lose some hearing if exposed to sufficiently intense noise for a period of time. The U.S. Government's Occupational Safety and Health Administration (OSHA) has specified the permissible noise level exposures shown in the following chart.

According to OSHA, any exposure in excess of these permissible limits could result in some hearing loss. To ensure against potentially dangerous exposure to high sound pressure levels, it is recommended that all persons exposed to equipment capable of producing high sound pressure levels use hearing protectors while the equipment is in operation. Ear plugs or protectors in the ear canals or over the ears must be worn when operating the equipment in order to prevent permanent hearing loss if exposure is in excess of the limits set forth here:

Duration, per day in hours	Sound Level dBA, Slow Response	Typical Example
8	90	Duo in small club
6	92	
4	95	Subway Train
3	97	
2	100	Very loud classical music
1.5	102	
1	105	The Ballard Mallard screaming at desTROYer about deadlines
0.5	110	
0.25 or less	115	Loudest parts at a rock concert

**CAUTION**

RISK OF ELECTRIC SHOCK! DO NOT OPEN!

CAUTION: TO REDUCE THE RISK OF ELECTRIC SHOCK DO NOT REMOVE COVER (OR BACK). NO USER-SERVICEABLE PARTS INSIDE. REFER SERVICING TO QUALIFIED PERSONNEL.

The lightning flash with arrowhead symbol within an equilateral triangle is intended to alert the user to the presence of uninsulated "dangerous voltage" within the product's enclosure, that may be of significant magnitude to constitute a risk of electric shock to persons.

The exclamation point within an equilateral triangle is intended to alert the user of the presence of important operating and maintaining (servicing) instructions in the literature accompanying the appliance.

**WARNING** — To reduce the risk of fire or electric shock, do not expose this apparatus to rain or moisture.

**CAUTION** — To prevent electric shock hazard, do not connect to mains power supply while grille is removed.

Laite on liitettävä suojakoskettimilla varustettuun pistorasiaan.

Apparatet må tilkoples jordat stikkontakt.

Apparaten skall anslutas till jordat uttag.

# Contents

- IMPORTANT SAFETY INSTRUCTIONS .....2
- CONTENTS / FEATURES .....3
- INTRODUCTION .....4
- QUICK START.....5
- REAR PANEL DESCRIPTION .....6
  - 1. POWER CONNECTION AND FUSE .....6
  - 2. VOLTAGE SELECTOR SWITCH.....6
  - 3. POWER SWITCH .....6
  - 4. SIGNAL INPUTS.....6
  - 5. SIGNAL OUTPUTS .....7
  - 6. AUTO POWER SWITCH AND LED.....7
  - 7. POLARITY SWITCH.....7
  - 8. CROSSOVER LEVEL.....7
  - 9. INPUT LEVEL .....7
  - 10. CUSTOM-TUNED REAR SHELF PORT.....7
- PROTECTION CIRCUITS .....8
  - OVEREXCURSION PROTECTION .....8
  - THERMAL PROTECTION.....8
  - INTEGRATED MAGNETIC SHIELDING.....8
  - INPUT SIGNAL WIRING.....8
- CARE AND CLEANING .....8
- THE INS AND OUTS OF POLARITY.....9
- APPENDIX A: SERVICE INFO .....10
  - TROUBLESHOOTING.....10
  - REPAIR.....11
- APPENDIX B: CONNECTORS.....12
- APPENDIX C: TECHNICAL INFORMATION .....13
  - MR10Smk3 SPECIFICATIONS.....13
  - MR10Smk3 DIMENSIONS .....14
  - MR10Smk3 BLOCK DIAGRAM.....14
- MR10Smk3 LIMITED WARRANTY .....15

# MR10Smk3 Features

- Powerful, deep extended bass for your MRmk3 studio monitors
- Designed for high-output and superior low-frequency performance
  - 120 watts of Class A/B amplification
  - 10" glass aramid composite woofer
- Shelf-ported for satisfying, deep low end
- Stereo XLR and TRS connection offer input flexibility
- Stereo balanced TRS outputs for connection to mains
- Adjustable 40 Hz to 180 Hz crossover point
- Polarity switch (0° / 180°)
- Rugged all-wood cabinet design built to last
- Vibration-absorbing rubber feet minimize undesirable resonances
- Low-profile, soft-mesh grille cloth delivers a sleek studio look
- Allows your mains to focus on highs/mids for optimum studio performance

Please write your serial number here for future reference (i.e., insurance claims, tech support, return authorization, make dad proud, etc.)

Purchased at:

Date of purchase:



Like us



Follow us



Watch our dang videos

## Introduction

Delivering the powerful, deep bass your music deserves, the MR10Smk3 Powered Studio Subwoofer is designed for high-output low end performance.

The low-profile enclosure is rear-ported to provide smooth, even bass that adds to the character of your music and also features vibration-absorbing rubber feet to minimize unwanted resonances.

Optimizing features include an adjustable crossover to dial in the right amount of low end for your studio, plus a polarity switch to make sure your mix is always in phase.

Adding an MR10Smk3 studio subwoofer to your studio not only delivers the added bass your music demands, it is perfectly matched to MRmk3 studio monitors to enrich your full range mix.

### A Brief History Of Time...

We have been designing and re-designing studio monitors and subwoofers for over 15 years. Our talented engineering team has now designed monitors and subwoofers that love music as much as you do. Targeted at music lovers and post-production studios alike, the new MR10Smk3 Powered Studio Subwoofer has been re-voiced and re-kitted, offering unparalleled clarity and unbelievable depth for today's demanding home project or post-production studio requirements.

### Music Is All That Matters

When designing the MR10Smk3 Powered Studio Subwoofer, we didn't start on paper. Instead, we poured through countless hours of music from every possible genre and source. From perfectly optimized electronics to amps and a woofer custom-matched for performance, the MR10Smk3 Powered Studio Subwoofer is designed for your music.

### Designed To Enhance Your Sonic Experience

The ability to reveal the character of your music is the number one reason to get professional studio monitors and subwoofers. The MR10Smk3 Powered Studio Subwoofer is packed with design features to enhance this experience. From the added punch and bass extension provided by the custom-tuned ports to the rugged all-wood cabinet packed with sound-tightening acoustic absorption material, you can be confident that this subwoofer is revealing the natural, low-end character that your music deserves.

## As Versatile As Your Application

All studio spaces are different. As such, having the right connection types and customizable control over your acoustics is necessary.

Adding an MR10Smk3 studio subwoofer to your system only adds to the experience. It not only delivers the chest-pounding punch critical for genres like hip-hop and dance, but also lets your mains focus on what they do best for optimum studio performance.

What's more, two types of professional input connectors are provided [XLR and 1/4"] to interface with virtually any application you may have.

Also, the variable crossover allows you to dial in the perfect amount of low end for your studio.

Your studio deserves a professional monitoring system with the flexibility and performance to up the level of your music production.

### A Variety Of Applications...

An MR10Smk3 Powered Studio Subwoofer may be used in a variety of applications. Some examples include:

- Home and project studios – Music production for solo artists, small bands and DJs. Post-production edit/mix suites, recording, editing, mixdown, mastering of everything from spoken word performances to full music productions.
- A/V broadcast studios – Live broadcast/streaming of audio-only or AV content such as radio and TV. Production/Post-production focused on podcasts or other streaming audio. Voiceovers, too.
- Video post-production – Edit suites for small productions such as commercials, budget films or multimedia for internet broadcast, etc.
- Home theater and other multimedia – Music and movie playback, video game sound system, social function/party system, etc.

## Quick Start

We realize that you can't wait to hook up your MR10Smk3 Studio Subwoofer and try it out. Nevertheless, please take the time to read this page NOW, and the rest can wait until you're good and ready.

1. Turn the input level [9] control on the back of the cabinet down (fully counterclockwise) before turning on the subwoofer for the first time.
2. Set the power switch [3] on the back panel off. This will prevent you from accidentally connecting a hot signal source to the subwoofer and getting a rude surprise.
3. Connect the L/R line-level signal from your mixer, interface, or other signal source to the input [4] jacks on the MR10Smk3 Studio Subwoofer (XLR or 1/4").
4. Connect the line-level signal from the output [5] jacks on the MR10Smk3 Studio Subwoofer (1/4") to the studio monitors' input jacks.
5. Connect the supplied AC power cord to the IEC socket [1] on the back of the subwoofer. Plug the other end into an AC outlet properly configured with the voltage corresponding to the markings next to the IEC socket.
6. Start your signal source (8-track player, turntable, CD player, DAW, or whatever), but leave the master volume control on the mixer or preamp down.
7. Turn on the power switch [3] on the MR10Smk3.
8. Slowly turn up the input level [9] control on the back of the subwoofer to center position (12 o'clock, aka unity gain).
9. Adjust the master volume on the mixer or preamp to a comfortably loud listening level.
10. Balance the subwoofer to your desired low-frequency output level and adjust the crossover [8] to your desired setting.

Enjoy the authoritative, commanding lows of the MR10Smk3. Then read the rest of this manual.

## An Extremely Important Note on MR10Smk3 Bass Response and Your Control Room



MR10Smk3s achieve the best bass response in a room that's optimized for bass reproduction. A lot of factors can conspire to thwart the MR10Smk3s' extended low frequency – including room shape, room volume and acoustical treatment.

This is not a cop-out or an apology. It's plain old physics in action. Luckily we've armed you with some compensating controls that you can use to optimize the frequency response of the speakers in your particular room. Consider the following:

When you put your MR10Smk3s in a corner or up against walls, their bass characteristics change. The apparent loudness of the low frequencies increases when the subwoofers are placed close to a wall, and even more so when they are placed in a corner.

### Additional Tidbits of Wisdom

- Never listen to loud music for prolonged periods. Please see the Safety Instructions on page 2 for information on hearing protection.
- When you shut down your equipment, turn off the MR10Smk3 studio subwoofers first to prevent thumps and other noises generated by any upstream equipment from coming out the speakers. When powering up, turn on the subwoofers last.
- Save the shipping box! You may need it someday.
- Save your sales receipt in a safe place. It's your warranty!

# Rear Panel Description

This is where the signal is connected to the subwoofer and adjustments are made to the frequency response of the speakers to match the subwoofer's location and the room's environment.

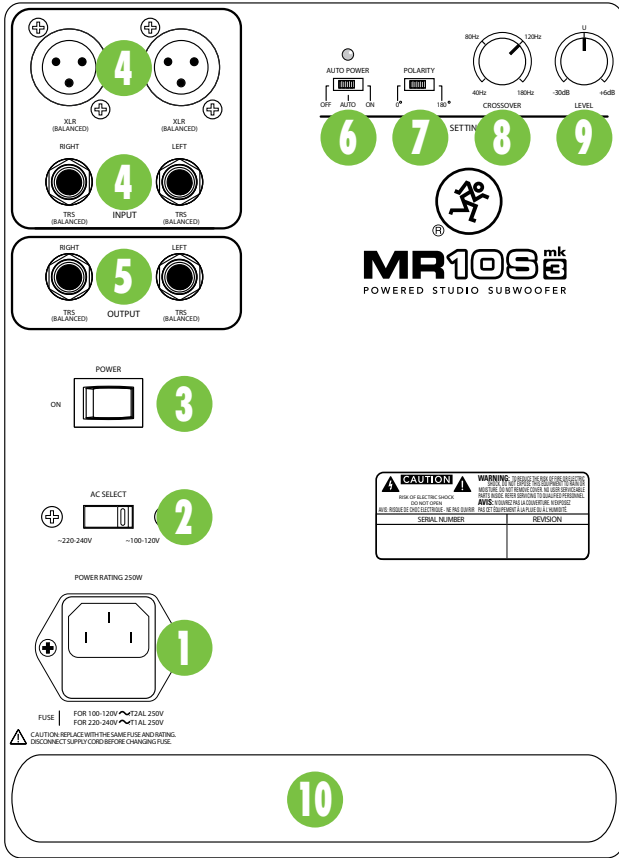

## 1. Power Connection and Fuse

Connect the power cord to this IEC socket securely, and plug the other end into a live AC outlet. Make sure the AC outlet has the correct voltage indicated below the IEC socket.



Disconnecting the plug's ground pin is dangerous. Don't do it!

The fuse is located behind the fuse cover, at the bottom of the IEC socket. See the "Troubleshooting" section on page 10 for information about replacing the fuse.

## 2. Voltage Selector Switch

Make sure the switch is in the correct position for your local AC mains voltage before connecting the AC power cord. Use a small flat screwdriver to slide the switch, if required.

## 3. Power Switch

Press this switch left to turn the MR10Smk3 studio subwoofer on. Make sure the level control [9] is down before you turn it on. When the power switch is turned on and the MR10Smk3 studio subwoofer is plugged into an AC outlet, the LED [6] illuminates to let you know that it's ready to go.

Press the right side of this switch down to put the subwoofer into standby mode. It will not function, but the circuits are still live. To remove AC power, either turn off the AC supply, or unplug the power cord from the speaker and the AC supply.

## 4. Signal Inputs

Connect the line-level signal from the mixer (or other signal source) to these input jacks. Balanced XLR and 1/4-inch female connectors are provided for the left and right inputs.

They are wired as follows, according to standards specified by the AES (Audio Engineering Society):

### Balanced XLR

Hot (+)	Pin 2
Cold (-)	Pin 3
Shield (Ground)	Pin 1

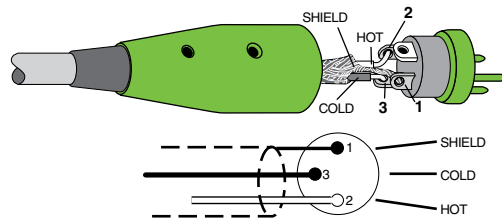

Balanced XLR Connectors

### Balanced 1/4" TRS

Hot (+)	Tip
Cold (-)	Ring
Shield (Ground)	Sleeve

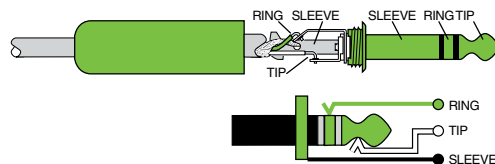

Balanced 1/4" Connectors

For more information on these connectors, see Appendix B on page 12.



## 5. Signal Outputs

Connect these output jacks to the input jacks of studio monitors. Balanced 1/4" female connectors are provided for the left and right outputs.

The frequency range depends on where the crossover level [8] is set.

These output jacks are wired as follows, according to standards specified by the AES (Audio Engineering Society):

### **Balanced 1/4" TRS**

Hot (+)	Tip
Cold (-)	Ring
Shield (Ground)	Sleeve

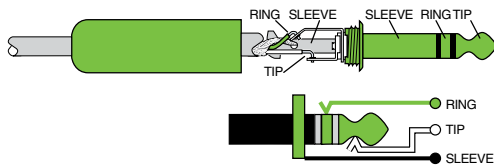

**Balanced 1/4" Connectors**

## 6. Auto Power Switch and LED

This 3-position switch turns the amplifiers on or off, or sets them to automatic mode. Use this switch to set the MR10Smk3 to your preferred mode of operation.

- In the OFF position, the power amplifiers are off and the MR10Smk3 subwoofer produces no sound. Low-level circuitry is still active, but the power consumption of the circuitry is minimal.
- Flip the switch to the ON position and the power amplifiers are live and operate normally.
- When this switch is in the AUTO position, the amplifiers turn on and off depending on the presence or absence of an input signal. An input signal of at least -40 dBu activates the auto-on function. A silent period greater than 13 minutes activates the auto-off function.

The LED above the switch will illuminate GREEN indicating that signal is present in the MR10Smk3 subwoofer.

The LED above the switch will illuminate RED indicating that the MR10Smk3 subwoofer is being pushed too hard. Turn down the main mix level on the mixer (or other input source) or input level [9] on the subwoofer.

## 7. Polarity Switch

This switch – when left – sends a normal (0°) polarity of the signal into the subwoofer amplifier. It has no effect on the signal at the outputs.

This switch – when right – reverses the polarity of the signal going into the subwoofer amplifier by 180°. It has no effect on the signal at the outputs.

There is no right or wrong setting for this switch. Listen to the overall blend of the subwoofer with the rest of the system and select the switch position that gives you the best sound for your audience. In fact, your system may vary when positioned differently and in alternate venues. Don't be afraid to experiment with the position of the polarity switch. See page 9 for more information.

## 8. Crossover Level

The MR10Smk3 crossover allows you to choose a crossover frequency for studio monitors, ranging from 40 Hz to 180 Hz.

Listed below are the recommended crossover frequencies for each MRmk3 full-range monitor, but use them as a guideline. Set the crossover level to what sounds best to your ears.

- MR5mk3 : 57 Hz
- MR6mk3 : 46 Hz
- MR8mk3 : 40 Hz

## 9. Input Level

MR10Smk3 studio subwoofers expect a line-level signal at its input. Use this control to adjust the sensitivity of the input section according to the signal strength at its input.

- Balance the subwoofer to your desired low-frequency output level and adjust the crossover [8] to your desired setting.

## 10. Custom-Tuned Rear Shelf Port

The custom-tuned rear shelf port uses the radiation from the rear of the woofer cone to extend the low-frequency response of the speaker. The size of the port is carefully designed with respect to the volume of the cabinet and the characteristics of the woofer to produce low-frequency extension.

## Protection Circuits

There are several protection mechanisms designed into the MR10Smk3 studio subwoofers to safeguard the speakers and amplifiers from inadvertent damage.



**CAUTION:** The protection circuits are designed to prevent damage to the speakers under reasonable and sensible conditions. Should you choose to ignore the warning signs (i.e., excessive distortion), you can still damage the speaker in the MR10Smk3 studio subwoofer by overdriving it. Such damage is beyond the scope of the warranty.

### Overexcursion Protection

A 12 dB/octave high-pass filter just prior to the low-frequency amplifier prevents very low frequencies from being amplified. Excessive low-frequency energy can damage the woofer by causing it to “bottom out,” also known as overexcursion, which is equivalent to a mechanical form of clipping.

### Thermal Protection

All amplifiers produce heat. The MR10Smk3 studio subwoofer is designed to be efficient both electrically and thermally.

- If for some reason the heatsink gets too hot, a thermal switch activates and turns off the amplifier.
- When the heatsink cools down to a safe temperature, the thermal switch resets and normal operation resumes.
- If the heatsink temperature again gets too hot, the shutdown process repeats. Should this happen, make sure that airflow to the rear of the cabinet is not restricted.

### Integrated Magnetic Shielding

MR10Smk3 studio subwoofers contain drivers with large magnetic structures. The drivers' magnets are not shielded. Unshielded speakers can cause distortion in both the shape and color of the picture if placed too close to a CRT (cathode ray tube). If you have a particularly sensitive computer monitor or TV screen, it may be necessary to move the speakers a few inches away.

## Input Signal Wiring

We recommend using high-quality, shielded cables to connect the signal source to the signal input jacks [4] on MR10Smk3 studio subwoofers.

Two types of input connectors are provided to interface with virtually any application you may have:

- Balanced microphone cables work well with the XLR inputs.
- Balanced TRS cables work well with the 1/4" inputs.

**NOTE:** Route the cable away from AC power cords and outlets. These are common sources for hum in an audio signal. Wall warts and line lumps are especially insidious hum inducers!

**NOTE:** In certain home theater applications, it may be necessary to connect the speaker outputs from a stereo receiver to the inputs of the MR10Smk3 studio subwoofer if the receiver doesn't have preamp outputs or other line-level output connections.



**CAUTION:** Do not attempt to connect a speaker output directly to the input of the MR10Smk3 studio subwoofer! Speaker levels are much higher than line levels and can damage the input circuitry in the MR10Smk3 studio subwoofer.

However, it is possible to insert a speaker-level to line-level signal attenuator between the receiver's speaker output and the MR10Smk3 studio subwoofer's input. Any local authorized dealer should be able to assist, or you can build your own.

More information (with illustrations!) may be found in Appendix B on page 12.

## Care and Cleaning

MR10Smk3 Reference Studio Subwoofers will provide many years of reliable service if you follow these guidelines.

- Avoid exposing the subwoofers to moisture.
- Avoid exposure to extreme cold (below freezing temperatures).
- Use a dry cloth to clean the cabinets. Only do this when the power is turned off.



## The Ins and Outs of Polarity

The MR10Smk3 studio subwoofer includes a switch that allows you to quickly invert the polarity of the subwoofer's output relative to the input signal it is receiving from the mixer or other sound source. But what exactly does that mean? A subwoofer works by literally pumping air as the woofer cone moves in and out with respect to the cabinet in which it is housed. It does so according to the low-frequency portion of the signal it receives from the sound source.

The woofer cone is simply following the waveform as seen in the sine wave in Figure 1. As the sine wave rises, the woofer cone pushes out. Likewise, as the sine wave falls, the woofer cone pulls into the cabinet. A musical signal is much more complex, of course, but the same principle applies. Movement of the woofer cone causes air pressure changes that we perceive as sound.

When the polarity switch [7] is to the right, the original waveform is simply reversed  $180^\circ$  [see Figure 2]. Again, the subwoofer cone follows the waveform. However, this time the woofer cone starts by pulling into the cabinet followed by the woofer cone pushing out. If you have ever experimented with a subwoofer polarity switch, you may not have noticed any changes to the sound regardless of its position, especially if you are listening to just the subwoofer. This is normal, as our ears perceive them both at the same time.

The polarity switch comes into play when the MR10Smk3 studio subwoofer is paired with a studio monitor. Ideally, the woofer cones of the subwoofer and monitor would work together by pushing and pulling in unison. MR10Smk3 studio subwoofers are designed to be used in a broad range of applications. The flexibility provided by the polarity switch is necessary to ensure that you are receiving the best possible sound from your system, regardless of your setup.

### Polarity Waveforms

Figure 1:  $0^\circ$

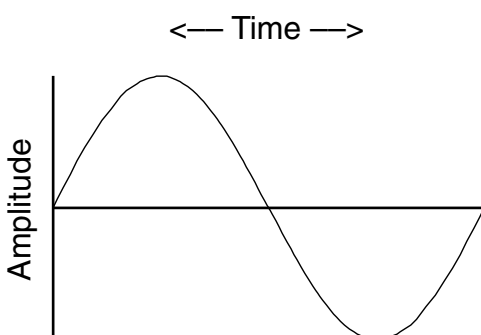
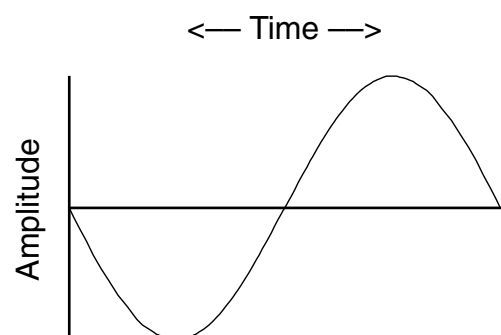

Figure 2:  $180^\circ$



## Appendix A: Service Information

If you think your MR10Smk3 Studio Subwoofer has a problem, please check out the following troubleshooting tips and do your best to confirm the problem. Visit the Contact Tech Support section of our website ([www.720trees.com](http://www.720trees.com)) where you will find lots of useful information such as FAQs and other documentation. You may find the answer to the problem without having to send your MR10Smk3 away.

### Troubleshooting

#### No Power

- Our favorite question: Is it plugged in?
- Make sure the power cord is securely seated in the IEC socket [1] and plugged all the way into the AC outlet.
- Make sure the AC outlet is live (check with a tester or lamp).
- Is the power [3] switch on the rear panel in the ON position?
- Is the power LED [6] on the rear panel illuminated? If not, make sure the AC outlet is live. If so, refer to “No Sound” to the right.
- If the power indicator is not illuminated, and you are certain that the AC outlet is live, it is possible the fuse has blown.

#### To remove and replace the fuse:

1. Disconnect the power cord from the IEC socket.
2. Remove the fuse drawer by prying it open with a small screwdriver. It will slide all the way out.

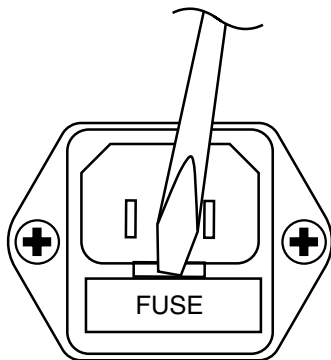

3. Remove the fuse and replace it with an equivalent-type fuse.
  - 100-120V unit: 2.5 amp slo-blo (T2AL/250V)
  - 220-240V unit: 1.25 milliamp slo-blo (T1AL/250V)
4. Replace the fuse drawer by pushing it all the way back into the IEC socket.

If two fuses blow in a row, then something is very wrong. See the “Repair” section on the next page to find out how to proceed.

#### No Sound

- Is the power LED [6] on the rear panel illuminated? If not, refer to “No Power” to the left.
- Is the input level [9] control turned up?
- Is the signal source turned up? Make sure the signal level from the mixing console (or whatever device immediately precedes the studio subwoofer) is high enough to produce sound.
- If it's a stereo pair, try switching them around. For example, if a left output is presumed dead, switch the left and right cords at the subwoofer end. If the problem switches sides, it's not the subwoofer. It could be a bad cable, or no signal from the mixer.

#### Bad Sound

- Is the input connector plugged completely into the jack? If using a ¼" plug, make sure it is plugged all the way in.
- Is it loud and distorted? Reduce the signal level at the mixer.
- If possible, listen to the signal source with headphones plugged into the preamp stage. If it sounds bad there, it's not the subwoofer.
- Too much bass or not enough bass? Move around the room and see if the bass response changes. It's possible your listening position coincides with a room mode where the low frequencies either become exaggerated or nulled. If so, try moving the subwoofers to a different position, or moving your listening position.

#### Noise/Hum/Buzz

- Check the signal cable between the mixer and the subwoofer. Make sure all connections are secure. These problems usually produce crackling noises, hum, or buzz.
- If a CATV cable is connected to the system, try disconnecting it. If the hum goes away, call your cable carrier to check for proper grounding of the cable.
- Make sure the signal cable is not routed near AC cables, power transformers, or other EMI sources (including wall warts and line lumps!). These sources usually produce hum.
- Is there a light dimmer or other triac-based device on the same AC circuit as the subwoofer? Dimmers cause buzzing noises. Use an AC line filter or plug the subwoofer into a different AC circuit.
- Excessive hiss is an indication of an incorrect gain setting somewhere before the speaker.
- If possible, listen to the signal source with headphones plugged in. If it sounds noisy there, it's not the subwoofer.

## Repair

For warranty service, please refer to the warranty information on page 15.

Non-warranty service is available at a factory-authorized service center. To locate the nearest service center, visit [www.720trees.com](http://www.720trees.com), click "Contact Tech Support" and select "Locate a Service Center or Distributor" [3]. Service for an MR10Smk3 living outside the United States may be obtained through local dealers or distributors.

If you do not have access to our website, please call our Tech Support department at 1-800-898-3211 (normal business hours, Pacific Time), to explain the problem. They will tell you where the nearest factory-authorized service center is located in your area.

### Need help with your MR10Smk3 Studio Subwoofer?

- Visit [www.720trees.com](http://www.720trees.com) and click Support to find: FAQs, manuals, and addendums.
- Email us at: [techmail@loudtechinc.com](mailto:techmail@loudtechinc.com).
- Telephone 1-800-898-3211 to speak with one of our splendid technical support chaps (Monday through Friday, normal business hours, Pacific Time).

## Appendix B: Connectors

### Balanced XLR Input Connector

XLR connectors are used to make balanced connections to the MR10Smk3 studio subwoofers. They are wired as follows, according to standards specified by the AES (Audio Engineering Society).

#### XLR

- Pin 1 – Shield (Ground)
- Pin 2 – Positive (+ or hot)
- Pin 3 – Negative (– or cold)

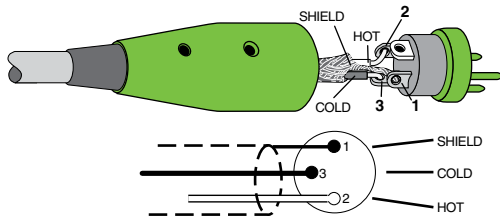

*Balanced XLR Connectors*

### Balanced 1/4" TRS Input Connector

“TRS” stands for Tip-Ring-Sleeve, the three connections available on a stereo 1/4" or balanced phone jack or plug. TRS jacks and plugs are used to make balanced connections to the MR10Smk3 studio subwoofers.

#### 1/4" TRS Balanced Wiring:

- Tip – Positive (+ or hot)
- Ring – Negative (– or cold)
- Sleeve – Shield (Ground)

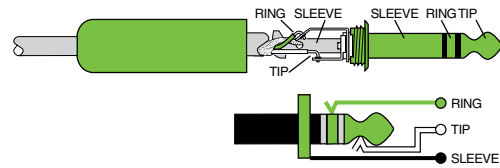

*Balanced 1/4" Connectors*

# Appendix C: Technical Information

## MR10Smk3 Specifications

### Acoustic Performance

Free Field Frequency Response (-3 dB):	35 Hz – 180 Hz
Free Field Frequency Response (-10 dB):	28 Hz – 180 Hz
Sound Pressure Level @ 1 meter, +4 dBu into Balanced Input:	113 dB SPL @ 1m
Maximum SPL Per Pair:	119 dB SPL @ 1m

### Transducers

Low Frequency:	10 in / 254 mm hyperbolic curved cone woofer
----------------	--

### Amplifiers

Low Frequency Power:	120 watts, 4 Ω load, 240 watts peak
Type:	Monolithic IC, Class AB with DMOS power stage

### Electronic Crossover

Crossover Type:	12 dB/octave
Crossover Frequency:	40 Hz – 180 Hz [Adjustable]
Sensitivity:	+4 dBu at 65 Hz for full output
Input Impedance:	20 kΩ, balanced bridging; 10 kΩ unbalanced

### AC Power Requirements

US:	120 VAC, 60 Hz
Europe:	240 VAC, 50 Hz
Korea:	220 VAC, 60 Hz
Japan:	100 VAC, 50/60 Hz

**Note:** MR10Smk3 subwoofers do not support multiple voltage configurations. Make sure the voltage rating for your particular model (as indicated on the rear panel near the IEC socket) corresponds with your local AC mains voltage.

AC Connector:	3-pin IEC 250 VAC, 16 A male
Fuse:	115 VAC: T 2.5 AL / 250 V 230 VAC: T 1.25 mA / 250 V

Power Consumption:	250 watts with music, loud mix 13 watts quiescent (idle)
--------------------	---

### Physical Dimensions and Weight

Enclosure:	0.625 in / 15 mm thick MDF with 0.98 in / 25 mm MDF front panel
Damping:	Adiabatic batting
Dimensions:	
Height:	15 in / 381 mm
Width:	12.6 in / 320 mm
Depth:	15 in / 381 mm
Weight:	27.3 lb / 12.4 kg

### Disclaimer

LOUD Technologies is always striving to improve our products by incorporating new and improved materials, components and manufacturing methods. Therefore, we reserve the right to change these specifications at any time without notice.

The following are trademarks or registered trademarks of LOUD Technologies Inc.: MR Series and the Running Man. This manual also contains names and marks of other companies which belong to those respective companies, and are hereby acknowledged.

©2015 LOUD Technologies Inc. All Rights Reserved.

# MR10Smk3 Dimensions

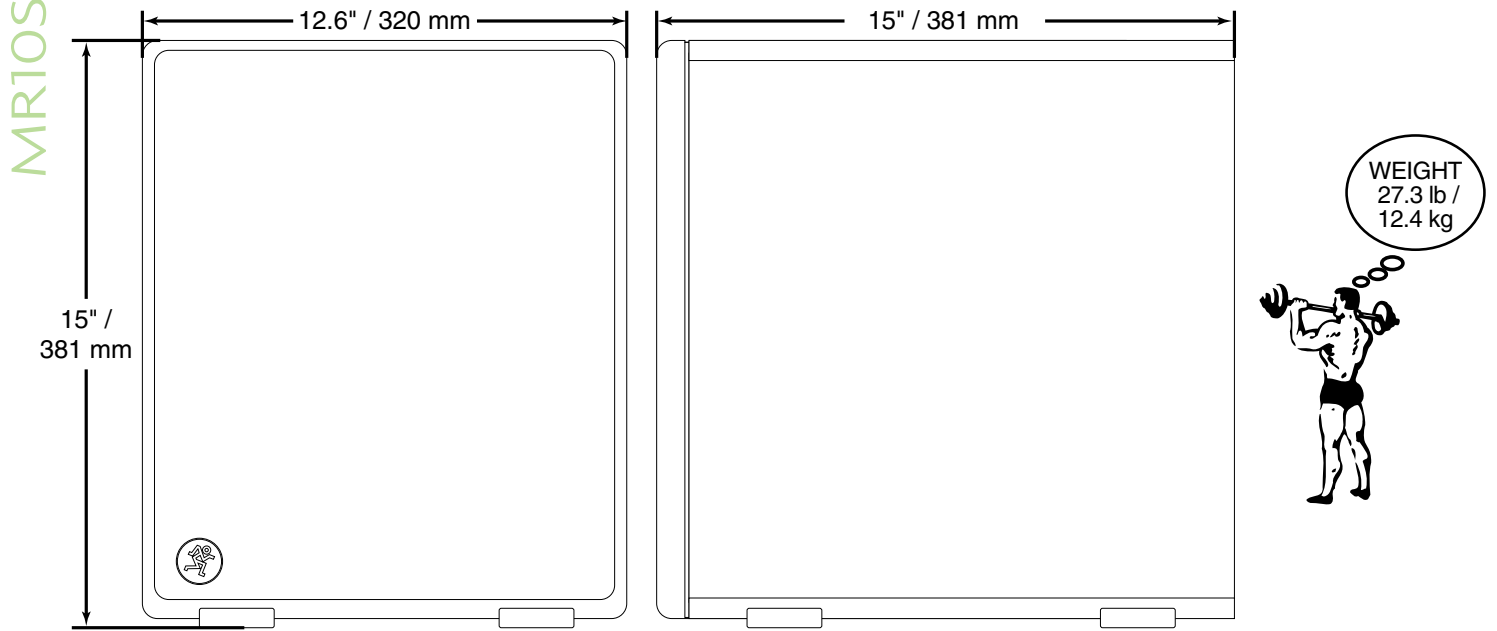

# MR10Smk3 Block Diagram

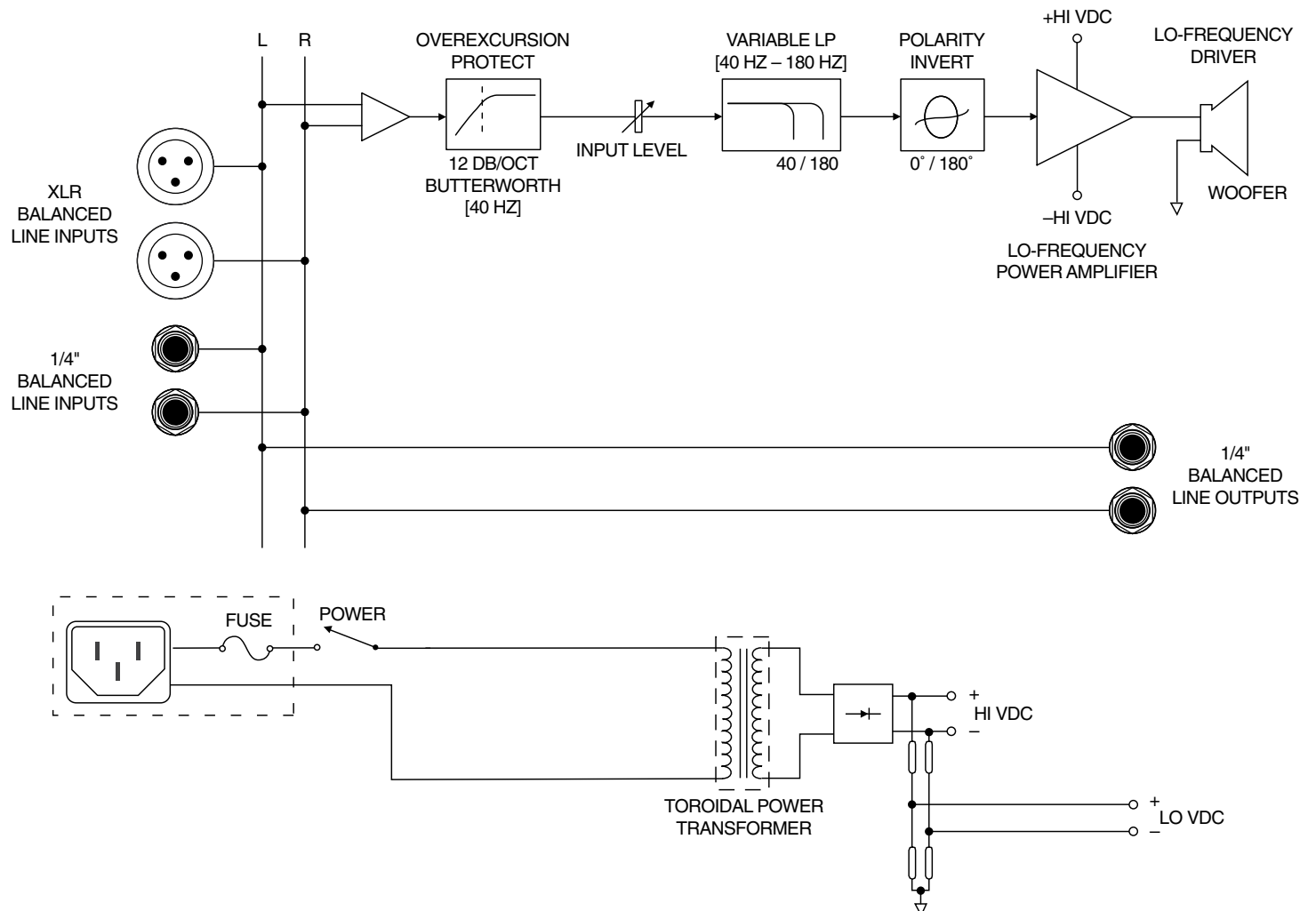



## Please keep your sales receipt in a safe place.

This Limited Product Warranty ("Product Warranty") is provided by LOUD Technologies Inc. ("LOUD") and is applicable to products purchased in the United States or Canada through a LOUD-authorized reseller or dealer. The Product Warranty will not extend to anyone other than the original purchaser of the product (hereinafter, "Customer," "you" or "your").

For products purchased outside the U.S. or Canada, please visit [www.720trees.com](http://www.720trees.com) to find contact information for your local distributor, and information on any warranty coverage provided by the distributor in your local market.

LOUD warrants to Customer that the product will be free from defects in materials and workmanship under normal use during the Warranty Period. If the product fails to conform to the warranty then LOUD or its authorized service representative will at its option, either repair or replace any such nonconforming product, provided that Customer gives notice of the noncompliance within the Warranty Period to the Company at: [www.720trees.com](http://www.720trees.com) or by calling LOUD technical support at 1.800.898.3211 (toll-free in the U.S. and Canada) during normal business hours Pacific Time, excluding weekends or LOUD holidays. Please retain the original dated sales receipt as evidence of the date of purchase. You will need it to obtain any warranty service.

For full terms and conditions, as well as the specific duration of the Warranty for this product, please visit [www.720trees.com](http://www.720trees.com).

The Product Warranty, together with your invoice or receipt, and the terms and conditions located at [www.720trees.com](http://www.720trees.com) constitutes the entire agreement, and supersedes any and all prior agreements between LOUD and Customer related to the subject matter hereof. No amendment, modification or waiver of any of the provisions of this Product Warranty will be valid unless set forth in a written instrument signed by the party to be bound thereby.



**Correct disposal of this product.** This symbol indicates that this product should not be disposed of with your household waste, according to the WEEE Directive (2012/19/EU) and your national law. This product should be handed over to an authorized collection site for recycling waste electrical and electronic equipment (EEE). Improper handling of this type of waste could have a possible negative impact on the environment and human health due to potentially hazardous substances that are generally associated with EEE. At the same time, your cooperation in the correct disposal of this product will contribute to the effective usage of natural resources. For more information about where you can drop off your waste equipment for recycling, please contact your local city office, waste authority, or your household waste disposal service.



---

**16220 Wood-Red Road NE**  
**Woodinville, WA 98072 • USA**  
**Phone: 425.487.4333**  
**Toll-free: 800.898.3211**  
**Fax: 425.487.4337**  
**[www.720trees.com](http://www.720trees.com)**

---