



MultiView™ II ***XRTx*** Transmitter



Installation and User Guide

© 1998-2012 by Magenta Research, Ltd. All rights reserved.

Magenta Research, Ltd.
128 Litchfield Road
New Milford, CT 06776 USA

This document and the Magenta Research Ltd. products to which it relates, and the copyright in each, is the property of Magenta Research Ltd. Neither the document nor the products may be reproduced by any means, in whole or in part, without the prior written permission of Magenta Research. Magenta Research makes no warranty or representation, either express or implied, with respect to this software or documentation, including their quality, performance, merchantability, or fitness for a particular purpose. As a result, this software or documentation is licensed "as is" and you, the licensee, are assuming the entire risk as to their quality and performance.

In no event will Magenta Research be liable for direct, indirect, special, incidental, or consequential damages arising out of the use of or inability to use the hardware, software or documentation.

*Magenta Research and the Magenta Research logo are trademarks of Magenta Research, Ltd.
All other brands, product names, and trademarks are the property of their respective owners.*

Magenta Research reserves the right to change product functionality and/or specifications at any time without prior notification.

Precautions

Safety Instructions • English



This symbol calls attention to important information.



This symbol is intended to alert the user of important maintenance (servicing) and operating information.



This symbol is intended to alert the user to the presence of un-insulated dangerous voltages or other conditions in or around the product enclosure which may present a risk of electric shock, damage to equipment or facilities.

Caution:

Read instructions: Read and understand all operating, installation and safety instructions before using this equipment.

Avoid Attachments: Do not use accessories, attachments, tools or materials that are not recommended by the equipment manufacturer. Doing so may compromise operating performance, create an unsafe condition, damage equipment, or violate the terms of usage or warranty.

Follow Warnings: Always follow all instructions and warnings marked on the equipment or as detailed in the related user documentations.

Contact Information

For sales or technical support, contact your nearest Magenta Research sales office.

REGION	CONTACT DETAILS
North, Central and South Americas: Magenta Research, LTD Corporate Headquarters 128 Litchfield Road New Milford, CT 06776 USA	Main: 800-805-0944 (USA only) or +1 860-210-0546 Fax: 1-860-210-1758 Web: www.magenta-research.com Sales: sales@magenta-research.com Support: techsupport@magenta-research.com Sales/Support phone hours: 7:00-19:00 (EST: GMT-0500)
Asia: Magenta Research Asia Limited Unit 1 21/F Cheung Tat Centre Chai Wan, Hong Kong	Main: 852.3105.1493 Fax: 852.3105.1491 Contact: awaung@magentaresearch-asia.com Sales: awaung@magentaresearch-asia.com
Pan European Office (includes Japan, Australia, etc.): Magenta Research, LTD	Main: +44 7708-850582 Contact: rmuddiman@magenta-research.com Sales: sales@magenta-research.com
For all RMA return shipments, use this address unless you are advised otherwise: Magenta Research, LTD RMA Department 128 Litchfield Road New Milford, CT 06776 USA	Prior to returning any products, please contact Magenta's support line to obtain an RMA number. This RMA number is essential for tracking your returns and for ensuring they are processed in a timely manner. Support Phone: 800-805-0944 (USA only) or +1 860-210-0546 Support e-mail: techsupport@magenta-research.com Support phone hours: 7:00-19:00 (EST: GMT-0500)

Table of Contents

	Page
Chapter 1	About this Manual 1
Chapter 2	Product Overview..... 2
	2.1 Front Panel Interfaces..... 2
	2.2 Rear Panel Interfaces 2
Chapter 3	Specifications 3
	3.1 General Specifications 3
	3.2 VGA Interface Specifications 3
	3.3 DDC Support..... 5
	3.4 Auxiliary Signal Support 6
	3.4.1 Auxiliary Signal Support: (A) and (S) Versions 6
	3.4.2 Auxiliary Signal Support: (232) Version 7
	3.4.3 Auxiliary Signal Support: (SA) Version 7
	3.4.4 Auxiliary Signal Support: (SAP) Version 8
	3.5 CAT5 Cable Compatibility 8
Chapter 4	Installation 10
	4.1 Prerequisites 10
	4.2 Installation Procedure 11
	4.3 Configuration 13
	4.3.1 User-Configurable Settings 13
	4.3.2 DDC Settings 14
	4.4 Sync Settings 15
	4.5 4 th Pair Settings 16
	4.6 Video Coupling Settings 17
	4.7 Video Termination Settings 17
Chapter 5	Troubleshooting 18
Appendix A	Connector Pinouts 20
Appendix B	Option Module Settings: XRTx-232 25
Appendix C	Option Module Settings: XRTx-SAP 27
Appendix D	Mounting Kits 30
Appendix E	System Design Drawings 32
Appendix F	Regulatory Compliance Information 33
INDEX 34

Chapter 1 About this Manual

This manual describes the Magenta MultiView™ II XRTx transmitter (hereafter referred to simply as “XRTx”) and contains the following information:

- Product overview (Chapter 2)
- Product specifications (Chapter 3)
- Installation and configuration instructions (Chapter 4)
- Troubleshooting (Chapter 5)
- Additional information (Appendices)

The Magenta MultiView™ II family of products introduces greater compatibility for handling HD video standards, as well as making nearly all user-configurable options “jumperless” via a digital front-panel user-interface.

The following table shows the factory-configured versions of the XRTx.

Table 1: XRTx Versions

Version	Description
MVII-XRTx-A	<ul style="list-style-type: none"> • Supports L+R summed audio (user-configuration setting).
MVII-XRTx-S	<ul style="list-style-type: none"> • Supports simplex serial (user-configuration setting).
MVII-XRTx-232	<ul style="list-style-type: none"> • Supports 9-wire RS-232 serial (simplex or duplex TX/RX with hardware handshaking). • Contains the (232) option module.
MVII-XRTx-SA	<ul style="list-style-type: none"> • Supports 3-wire RS-232 serial (simplex or duplex), and true stereo audio. • Contains the (SA) option module.
MVII-XRTx-SAP	<ul style="list-style-type: none"> • Supports 3-wire RS-232 serial (simplex or duplex), and true stereo audio. • The serial feature is POLLABLE, so that multiple receivers on a daisy-chained link can be addressed individually for display control or status-query. • Contains the (SAP) option module.



This equipment is not intended for, nor does it support, distribution through an Ethernet network. Do not connect these devices to any sort of networking or telecommunications equipment!



Use only Magenta Research LTD approved MultiView™ II power adapters. Failure to do so may damage this device and will void the warranty.

Chapter 2 Product Overview

The XRTx is a video transmitter compatible with the entire Magenta MultiView™ family of products. It extends an analog video signal over standard CAT5 cable (also CAT5e and CAT6). There are user-configurable settings for video, audio, and serial options which can be controlled from the front panel. When used with the appropriate receivers, the XRTx delivers the world's longest UTP extension capability at the highest resolution—1920x1200 at 2000ft/609m.

2.1 Front Panel Interfaces

The front panel of the XRTx has the following ports, controls, and indicators:

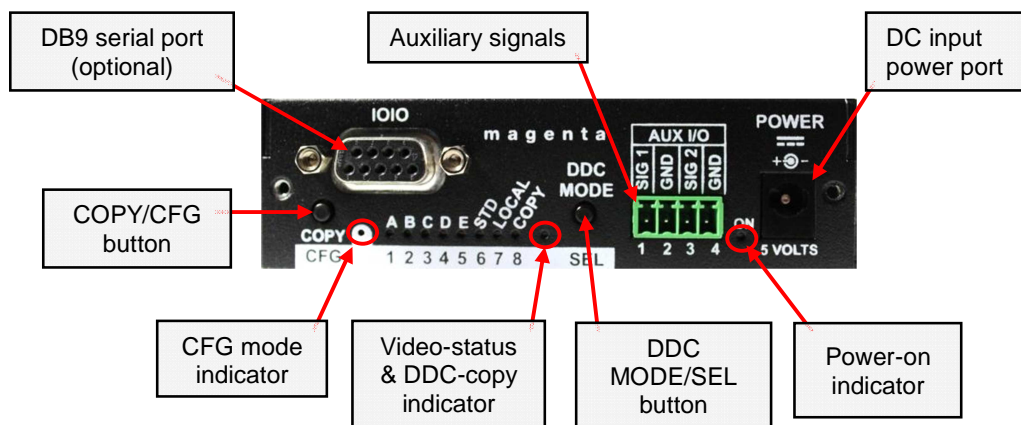

Figure 1: Front Panel Interfaces

There are two buttons (**COPY/CFG** and **DDC MODE/SEL**) and several green LED status indicators. All are used to display and control the operating modes of the transmitter, with the LEDs having multiple functions.

In “normal mode”, the **CFG** indicator is off. In “configuration mode”, the **CFG** indicator will be on or flashing.

2.2 Rear Panel Interfaces

The rear panel of the XRTx has the following ports:

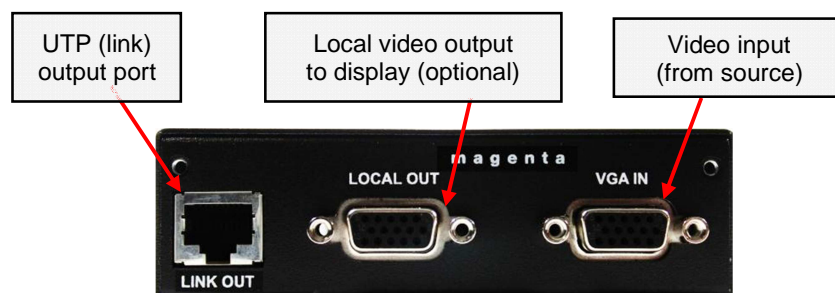

Figure 2: Rear Panel Interfaces

Chapter 3 Specifications

This section describes the following specifications:

- General specifications
- VGA interface specifications
- DDC support
- Auxiliary signal support
- CAT5 cable compatibility

3.1 General Specifications

The following table lists the general specifications of the XRTx.

Table 2: XRTx General Specifications

Item	Description
Cable Required	Category 5, 5e, 6 cable. Shielded or unshielded twisted pair. Low-skew preferred.
Compliance	CE, FCC Class A, IC Class / Class A, I.T.E Device, RoHS.
Video Support	VGA (RGB+HV). Also, component (YPbPr) and composite video formats are supported by using an optional media break-out cable.
Resolution & Refresh Rate	See the DDC Support topic
Interface Signal Details	<p>Video-input: Standard VGA interface specifications apply. DDC is supported.</p> <p>Standard auxiliary Signals (including -A and -S versions): L+R summed audio input: 47K ohms input impedance. A source device with 600 ohms maximum output impedance is recommended. (analog audio input mode). Simplex RS-232 input: 4.75K ohms input impedance (RS-232 mode). SPDIF input: 75 ohms input impedance (S/PDIF input mode). Duplex (232) option module: Audio: Not supported. Duplex input: 4.75K ohms input impedance. Duplex (SA) or (SAP) option modules: Stereo L/R audio input: 10K ohms input impedance. A source device with 600 ohms maximum output impedance is recommended. RS-232 input: 4.75K ohms input impedance.</p>
Local-output port drive impedance	The video output will be a direct copy any video input (even if the video input is in component (YPbPr) or composite format). If the video input is VGA, then standard VGA interface specifications apply (at local video-output port) and DDC is supported.
Audio Characteristics	<p>Standard (A) version: Left+Right summed audio. (232) version: This option module does not support audio. (SA) & (SAP) versions: Left/Right true stereo audio.</p>
Serial Characteristics	<p>Standard (S) version: Simplex-serial, any speed up to 115.2K baud. Transparent to format and protocol. Duplex (232) version: Any speed up to 115.2K baud (depending on application). Transparent to format and protocol. Refer to Appendix-B for more information. Duplex (SA) version: Speed fixed at 9600 baud. Transparent to format and protocol. Duplex (SAP) version: Speed is adjustable in 9 steps from 1200 to 115.2K baud; format is fixed to 8 data no parity; transparent to protocol.</p>
Connectors	<p>Standard connectors: (2) VGA-female: Video in/out. (1) RJ-45: MultiView™ II CAT5 link output. (1) 4 position phoenix: Auxiliary signal input. (1) Coaxial (5.5mm OD, 2.5mm ID, 11mm L) jack: DC power input.</p> <p>For (232), (SA) or (SAP) versions: (1) DB9-F: Serial I/O.</p>
Temperature Tolerance	Operating: 32 to 104°F (0 to 40°C) Storage: -4 to +140°F (-20 to +60°C)
Humidity Tolerance	Up to 80% non-condensing

Item	Description
Enclosure	Steel, black powder-coat finish.
Power	Input voltage: +5 VDC @ 1.2 Amps max. Consumption: 6 watts maximum
Size	1.2"H x 4.2"W x 4.3"D (3.1 x 10.4 x 10.9 cm)
Weight	1.0 lb. (0.45 kg)
MTBF	100,000 hours

3.2 VGA Interface Specifications

The following table describes the specifications of the VGA interface (video-in and local video-out).

Table 3: VGA Interface Specification

Item	Description
Video Support	Video input formats (video input port): Maximum resolution supported = 1080p or 1920x1200. Maximum refresh rate = 60Hz @ 1920x1200. Video output formats (local output port): The local port is essentially a direct copy of the video input port.
Video Connectors	(1) VGA input connector, (1) VGA output connector.
DDC	This module supports the DDC connections on the VGA connectors.

3.3 DDC Support

For best compatibility with source devices (e.g. a PC), an extension device (XRTx in this case) should provide an appropriate DDC profile with the proper resolution and timing information. This helps ensure best compatibility with display devices connected at the remote end.

The XRTx supports a simple yet very flexible DDC management scheme:

- The built-in factory-default DDC profile supports a number of standard resolutions and timing information that is widely compatible with many displays.
- A specific DDC profile can be copied from a particular display and stored inside the XRTx's non-volatile memory. This method enables the best possible compatibility with a specific display that would otherwise not work properly if simply using the factory-default DDC profile.
- Finally, the XRTx supports a "pass-through" mode, where the DDC profile of a locally attached display is passed directly to the video source. This can be very helpful in diagnosing certain resolution or timing related display issues, but generally is not used on a permanent basis (though it is safe to do so).

The following table describes DDC support specifications.

Table 4: DDC Support Specifications

Item	Description
DDC Parameter:	Presented to the source when using the XRTx transmitter:
Manufacturer name string	MRI
Monitor name string	Magic Display
Established timings	640x480@60Hz 800x600@60Hz 1024x768@60Hz 1280x1024@60Hz 1360x768@60Hz 1600x1200@60Hz 1680x1050@60Hz 1920x1080@60Hz 1920x1200@60Hz
Detailed timings	1920x1080@60Hz
CEA video formats	720x480p@(59.94,60Hz)@4:3 720x576p@50Hz@4:3 1280x720p@50Hz@16:9 1280x720p@(59.94,60Hz)@16:9 1920x1080p@50Hz@16:9 1920x1080p@(59.94,60Hz)@16:9
Specific timings	1280x720@60Hz 720x480@59.94Hz 1920x1200@59.94Hz

3.4 Auxiliary Signal Support

The XRTx is available in three factory-configured models and two user-configurable units, which allow different types of signals to be passed over the 4th-pair on the CAT5 cable. These are configured differently by a front-panel setting, or may include an internal hardware option-module. The following table describes the different versions of XRTx.

Table 5: XRTx Versions

Version	Description
MVII-XRTx-A	<ul style="list-style-type: none"> Supports L+R summed audio (user-configuration setting).
MVII-XRTx-S	<ul style="list-style-type: none"> Supports 2-wire RS-232 serial in simplex mode (user-configuration setting).
MVII-XRTx-232	<ul style="list-style-type: none"> Supports 9-wire RS-232 serial (simplex or duplex with hardware handshaking). Contains the (232) option module.
MVII-XRTx-SA	<ul style="list-style-type: none"> Supports 3-wire RS-232 serial (simplex or duplex), and true stereo audio. Contains the (SA) option module.
MVII-XRTx-SAP	<ul style="list-style-type: none"> Supports 3-wire RS-232 serial (simplex or duplex), and true stereo audio. The serial feature is POLLABLE, so that multiple receivers on a daisy-chained link can be addressed individually for display control or status-query. Contains the (SAP) option module.

Note: A user-configuration setting allows either the (A) or (S) versions to support digital S/PDIF audio.

The option module (232/SA/SAP) is a factory-installed option. However, a field upgrade to a (232), (SA) or (SAP) version is possible. It will require some minor technical skill to install the module. **Please contact Magenta Research for information and assistance for these upgrades.**

Note that for each XRTx version above, the accompanying receiver device (MV500, AK600, AK1200, XR2000, etc.) must be similarly configured.

For more specific information on MultiView™ and MultiView™ II receivers, please refer to the user guide provided with your desired receiver.

3.4.1 Auxiliary Signal Support: (A) and (S) Versions

XRTx models without any installed option module can be user-configured for any one of auxiliary function at a time. The following table describes the features of the (A) and (S) versions.

Table 6: XRTx-A and XRTx-S Features

Version	Description
(A) Version	<ul style="list-style-type: none"> Analog L+R summed audio.
(S) Version	<ul style="list-style-type: none"> Simplex RS-232 support. Provides simplex (TX-only) serial data, even with daisy-chained receivers. Data is transmitted to all attached receivers. No data can ever be received. Receivers are not individually addressable. RS-232 interface supports a 2-wire interface: TX/GND. Baud rates up to 115.2K are supported. No settings required. Transparent to format and protocol.

Note: A user-configuration setting allows either the (A) or (S) versions to support digital S/PDIF audio.

3.4.2 Auxiliary Signal Support: (232) Version

The XRTx-232 comes equipped with an internal hardware (232) option module, enabling full-duplex RS-232 serial. This includes hardware handshaking signal support. Note that the (232) module itself **does have** some user-configurable settings which must be selected by internal jumpers (not through the front-panel buttons). **It is important to set these internal jumpers correctly for your specific application. For more information, see Appendix-B.**

The following table describes features of the RS-232 version.

Table 7: XRTx-232 Features

Feature	Description
Simplex or Duplex RS-232 Support	<ul style="list-style-type: none"> Provides simplex serial data to single or daisy-chained multiple receivers. Provides duplex serial data for point-to-point links (1 transmitter → 1 receiver). Data is transmitted using “broadcast” mode. Receivers are not individually addressable. RS-232 interface supports a 9-wire interface: TXD/RXD/RTS/CTS/DTR/DSR/DCD/RI/GND. Handshaking modes depend on (232) module configuration. See Appendix-B. Baud rates up to 115,200 are supported. Available baud rates depend on (232) module configuration. See Appendix-B.
Audio	<ul style="list-style-type: none"> No audio is supported when the (232) module is installed. The AUX-I/O connector on the XRTx is ignored.

In applications where an XRTx-232 transmitter is routed through a DA (Distribution Amp, such as a MultiView™ 9D for example), or a Mondo (or other) video switch, the (232) module will provide simplex serial (TX-only) and transmit-direction handshaking signals (RTS/DTR). In this configuration, all receive-direction signals (RX/CTS/DSR/DCD/RI) are ignored.

3.4.3 Auxiliary Signal Support: (SA) Version

The XRTx-SA comes equipped with an internal hardware (SA) option module, enabling full-duplex RS-232 serial (no hardware handshaking signals) and stereo audio. Note that the (SA) module itself **does not have** any user-configurable settings. The following table describes features of the XRTx-SA.

Table 8: XRTx-SA Features

Feature	Description
Simplex or Duplex RS-232 Support	<ul style="list-style-type: none"> Provides simplex or duplex serial data point-to-point, simplex-only in a daisy-chain. Data is transmitted using “broadcast” mode. Receivers are not individually addressable. RS-232 interface supports a 3-wire interface: TXD/RXD/GND. Baud rate is fixed at 9600.
Audio	<ul style="list-style-type: none"> L/R true stereo audio <u>is supported</u> simultaneously with serial data.

Note that in cases where an XRTx-SA transmitter is routed through a DA (Distribution Amp) such as a MultiView™ 9D, for example, or a Mondo (or other) video switch, or used with daisy-chain receivers, the (SA) module will provide simplex serial (TX-only) and audio. In this mode, receive-direction serial data (RX) is ignored.

3.4.4 Auxiliary Signal Support: (SAP) Version

The XRTx-SAP comes equipped with an internal hardware (SAP) option module, enabling full-duplex RS-232 serial (no hardware handshaking signals) and stereo audio. Note that the (SAP) module itself **does have** some user-configurable settings that can be changed by on-board DIP-switches (not through the front-panel buttons). The following table describes features of the XRTx-SAP.

Table 9: XRTx-SAP Features

Feature	Description
Simplex or Duplex RS-232 Support	<ul style="list-style-type: none"> Provides simplex or duplex serial data, even with daisy-chained receivers. Data is transmitted using “broadcast” mode by default. If desired, receivers are individually addressable. Note that response-data will be accepted simultaneously from all receivers, which could cause communication problems unless they are uniquely addressed. However, if display devices have their own addressing scheme, then the default SAP “broadcast” behavior will likely be preferred – with the display-addressing being handled by the display-control software.” RS-232 interface supports a 3-wire interface: TX/RX/GND. Baud rate is adjustable in 9 steps from 1200 to 115K BAUD. The factory-default speed is 9600 BAUD. <p>Note: The SAP transmitter and receivers modules must have their SAP-address configured correctly. The factory-default setting for all (SAP) modules is address-0. This is the “broadcast” address.</p> <p>Note: All SAP-address configuration changes (via DIP switches, see Appendix C) should be done before making any cable connections and applying power.</p>
Audio	<ul style="list-style-type: none"> L/R true stereo audio <u>is supported</u> simultaneously with serial data. Audio gain/mute settings are under serial control.

The (SAP) module provides many additional user-configurable settings, available through the serial port. Please refer to the *SAP-II Programmer’s Guide* for additional details.

Note that in cases where an XRTx-SAP transmitter is routed through a DA (Distribution Amp) such as a MultiView™ 9D, for example, or a Mondo (or other) video switch (other than Mondo SAP), the (SAP) module will provide simplex serial (TX-only, though the addressable-receiver feature still works), and audio. In this mode, receive-direction serial data (RX) is ignored.

3.5 CAT5 Cable Compatibility

The MultiView™ and MultiView™ II family of products enables the highest quality video extension over common Category 5 (CAT5) cable. In some applications, system design or environmental factors can require the use of CAT5e and CAT6 cabling (with and without optional shielding). Each installation may have special requirements, and it is up to the system designer to determine the most appropriate type of cable to deploy with MultiView™ and MultiView™ II products. In any case, if there is any doubt with regards to a specific type of cable it is strongly advised that actual testing be performed using an appropriate length of the desired cable – BEFORE that cable is specified and installed.

The XRTx transmitter supports a daisy-chain CAT5 connection to multiple receivers. This allows one video source to be sent to many displays at the same time with the absolute minimum amount of signal degradation.

Magenta Research products are compatible with standard CAT5/5e/6 data cabling as well as specialized “low skew” cabling manufactured primarily for video applications. Note that some “low skew” cabling is specific to a particular equipment vendor or application and may not be compatible with MultiView™ or MultiView™ II products. Please ensure any “low-skew” CAT5 cable is non-proprietary prior to purchase/installation.

Standard CAT6 cable, due to the manufacture method, will require the addition of our skew-compensation module option. Some CAT6 cable can exhibit much greater skew than standard CAT6 and may require skew compensation beyond what the standard product offers. Please contact Magenta Research for assistance.

The CAT5/5e/6 cable should be suitably rated Listed cable (DUZX) communication cables, TYPE CMP, CMR, CMG or CM as designated in the NEC. Cables are to be installed in accordance with the NEC and local building and electrical codes. This is the responsibility of the end user/installer of this product.

Chapter 4 Installation

CAT5/5e/6 cabling for the Magenta MultiView™ II Series must be pinned to the TIA-EIA T568B wiring specification.

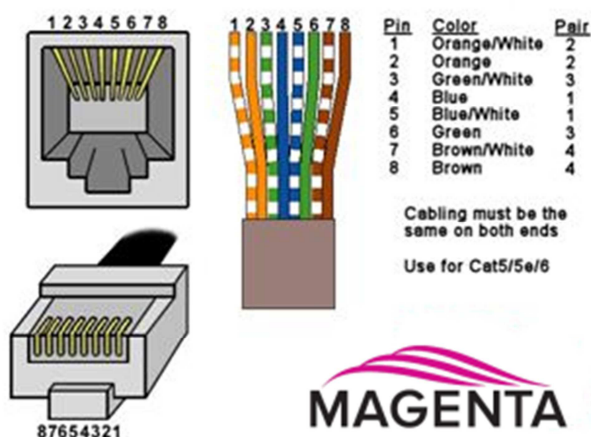

Figure 3: T568B CAT5 Specification

We also highly recommend that all CAT5 cables be pre-terminated and tested. Cables terminated on-site or in an existing infrastructure should be tested before use to ensure compliance with the TIA-EIA T568B specification. Using incorrectly terminated CAT5 cables can damage the Magenta MultiView™ II Series.



This equipment is not intended for, nor does it support, distribution through an Ethernet network. Do not connect these devices to any sort of networking or telecommunications equipment!



Do not connect DC power until instructed to do so.

4.1 Prerequisites

Depending on the specific installation requirements, some common tools (screwdrivers, nut-drivers) and related hardware (mounting screws) may be required. These are not provided with Magenta products.

The following items may be necessary, which are available from Magenta Research:

- Appropriate audio cabling.
- Appropriate YUV, S or C video adapter cabling.
- VGA video cable and/or DVI-to-VGA connector adapter (for DVI-I sources), as needed.
- Serial cable with DB9 connectors.

You need appropriate CAT5 cable, as previously described, to connect the XRTx to MultiView™ and MultiView™ II receivers and other MultiView™ and MultiView™ II devices.

4.2 Installation Procedure



All units must be the same type for all auxiliary features to function correctly. For example, an “XRTx-232” transmitter must be connected to a MultiView™ II “-232” type receiver for the serial interface to function properly. You cannot mix one version of an XRTx with a different version of a MultiView™ II receiver. Video modes may function normally, but 4th pair options will not.



Ensure all connectors are clean and free of contaminants prior to making the connections. Appropriate connector locking hardware (screws/latches) should be used to prevent cables from disconnecting or causing intermittent operation.

To install the XRTx at the transmitter end:

1. Connect the source video to the Magenta MultiView™ II Series transmitter video input port, which is a standard VGA connector labeled VGA IN.
2. If desired, attach a local monitor to the VGA connector labeled LOCAL OUT.
3. Connect the CAT5 cable to the transmitter LINK OUT port.
4. Make your audio or serial connections via the phoenix AUX I/O connector or DB9 “IOIO” serial connector, as appropriate for your XRTx transmitter model.
5. Connect the DC power cable (+5VDC @ 3A. max) to the POWER port.
6. Apply power on the transmitter.
 - a. The power-on LED should turn on. All other LEDs should execute a power-up test sequence.
 - b. If the video source is providing a valid video signal, the video-status indicator should turn on.
 - c. If there is a local monitor attached, a video image should appear on the monitor.
7. Remember to make any required configuration changes via the LED/button user-interface.

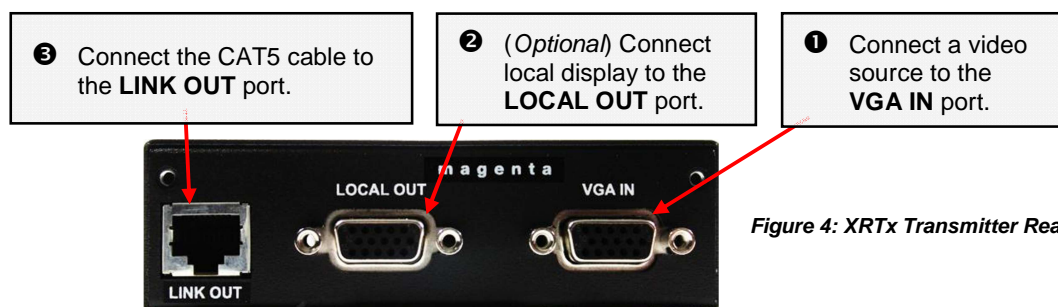

Figure 4: XRTx Transmitter Rear View

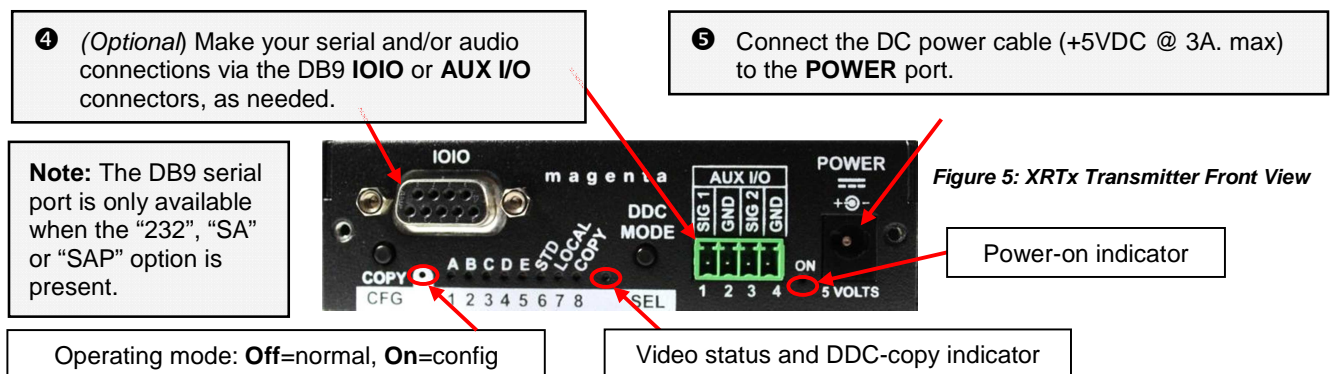

Figure 5: XRTx Transmitter Front View

To install the XRTx at the receiver end (these steps are generic - refer to the appropriate receiver manual):

1. Connect the VIDEO OUTPUT connector to the display, and attach any audio (AUX I/O) and/or serial connections (IOIO) depending on the model of MultiView™ II receiver and option module installed.
2. Connect the CAT5 cable to the LINK IN connector. If you are daisy-chaining multiple receivers, also connect the downstream CAT5 cable to the LINK OUT port on the receiver.
3. Apply power to the receiver.
 - a. The power-on LED should turn on (Green).
 - b. The status LED should turn on (Green).
4. Make any required configuration changes via the LED/button user-interface, if the receiver is equipped with this capability.
5. Adjust the receiver's EQ and/or SKEW (optional) settings. **If this adjustment is not made, it can result in a poor or no image on the display.**

4.3 Configuration

This section describes how to configure the following settings:

- User-configurable settings
- DDC settings

4.3.1 User-Configurable Settings

The XRTx has a number of configurable operating parameters, and the factory-default settings will work in most applications. However, some applications may require configuration changes. Nearly all settings are available from the front-panel buttons/LEDs. The enclosure does not need to be opened **unless** an option module is being installed or removed, or settings specific to the option module need to be changed.

The DDC MODE selection is done in NORMAL operating mode (CFG indicator is off).

- To change the DDC operating mode, press the **DDC MODE** button.

For all other configuration settings, the XRTx must be in CONFIG mode (CFG indicator is on). Once in CONFIG mode, any changes are effective immediately and are saved in non-volatile memory.

To enter configuration-mode-1:

- Press **CFG** button once. The **CFG indicator** will turn on, confirming you are in configuration-mode-1. Once in this mode, the LED indicators 1-8 will display the current settings.

To enter configuration-mode-2:

- Press **CFG** button twice. The **CFG indicator** will flash, confirming you are in configuration-mode-2. Once in this mode, the LED indicators 1-8 will display the current settings.

To exit configuration-mode:

- Leave the buttons untouched for 10 seconds. The **CFG indicator** will turn off (normal-mode).

To quickly reset all user-configurable options back to factory-default settings:

1. Disconnect the DC power cable (or AC power).
2. Press and hold the **CFG** button.
3. Connect the DC power cable (or AC power). All LEDs blink 3 times, indicating all settings are now changed back to factory-defaults.
4. Release the **CFG** button.

4.3.2 DDC Settings



These settings are accessed in NORMAL operating mode (CFG indicator is off).

The MultiView™ II XRTx features the ability to send DDC display identifiers to the video source in order to determine display capabilities. The DDC interface is a data communication channel used between *plug and play* devices to accurately report a display's capabilities and identify the manufacturer. If this data is not available, the video source may revert to a low resolution or not display at all.

The XRTx unit has three DDC modes of operation. When the XRTx is operating in “normal mode” (*CFG indicator is off*), it is possible to quickly select between the three operating modes by using the **DDC MODE** button at any time.

The following table describes the DDC modes.

Table 10: DDC Modes

Use this mode...	To select...	Description	To activate...
STD	the <i>Magenta Magic</i> DDC profile	This is the factory default mode which uses generic DDC information stored within the transmitter. It is also referred to as the Magenta Magic profile , and it is comprised of a set of common video resolutions which are intended to support the most popular VESA standards in standard or widescreen formats.	Press the DDC MODE button until the STD indicator (LED6) is on.
LOCAL	the DDC profile from a locally-connected display	The DDC information is transferred from a display connected to the local port of the transmitter back to the video source. This is only effective if a display is connected to the “local out” port - and it must remain connected at all times. This mode does not store any DDC profile information inside the XRTx device.	Press the DDC MODE button until the LOCAL (LED7) indicator is on.
COPY	a previously stored copy of a DDC profile	In this mode, DDC information comes from a DDC profile that was previously copied into the XRTx's non-volatile memory from a display device. To use this mode, a DDC profile must already have been stored into the XRTx.	Press the DDC MODE button until the LOCAL (LED8) indicator is on.

To perform a DDC-copy operation:

1. Activate COPY mode by pressing the **DDC MODE** button until the COPY (LED8) indicator is on.
2. Connect a display to the LOCAL OUT port. The display must be powered on.
3. Push and hold the **COPY** button until the copy-status indicator flashes 3 times, indicating the operation was successful. If it only flashes once, the operation failed and the previously stored DDC profile (if any) will remain unchanged.

4.4 Sync Settings





The XRTx is factory-configured for auto-detecting the proper sync-mode (RepliSync-I normal/stretched). This mode is generally compatible with all existing MultiView™ and MultiView™ II receiver products that support RepliSync (if they are also using their factory-default settings). However, some video sources may require a custom sync-mode setting (most especially at 1080p and 1920x1200 video resolutions). For these cases, one of the other available sync-modes can be selected.

Note that any connected MultiView™ or MultiView™ II receiver should generally be set to the same sync-mode and may require other configuration adjustments (such as sync-polarity). Otherwise, you may not get a proper video display output at that receiver, or none at all.

Perform the procedure below while the transmitter is in the normal operating state (**CFG** indicator is off):

1. Press and release the **CFG** button once to access configuration-mode (**CFG** indicator = on).
2. Press and release the **SEL** button **once**. You will now be able to change sync-mode settings.
3. LED indicators 1-3 should be illuminated (either DIM or ON); all others (indicators 4-8) should be off.
4. Press the **CFG** button repeatedly to step through the available sync-mode settings as shown below.
5. To leave configuration-mode step through all the options OR leave the buttons untouched for 10 seconds.

Table 11: Sync-Mode Settings

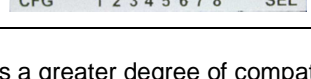
LED1	LED2	LED3	Front Panel View	Sync-Mode Setting
<u>dim</u>	<u>dim</u>	<u>dim</u>		The XRTx will auto-detect the required RepliSync-I mode ("normal" or "stretched"). This is the factory-default setting.
dim	dim	ON		Force RepliSync-I normal Horizontal sync-pulse encoding.
dim	ON	dim		Force RepliSync-I "stretched" Horizontal sync-pulse encoding.
dim	ON	ON		Force RepliSync-II.
ON	dim	dim		Force fixed-sync mode. Note: A connected MultiView™ or MultiView™II receiver must also be in fixed-sync mode and with H/V polarities selected at the receiver.

Note: RepliSync-II provides a greater degree of compatibility with high-definition formats such as 1080p and 1920x1200. Any connected receivers must also be set for RepliSync-II mode for this mode to be effective. RepliSync-II mode is only available with MultiView™ II receivers.

4.5 4th Pair Settings

The XRTx provides several options for using the 4th-pair signals (pairs 1-3 are generally used for video). Note that any connected MultiView™ or MultiView™ II receiver must be configured with a matching 4th-pair operating mode. Otherwise, the desired 4th-pair signal will not work as expected.





If an optional daughterboard is installed (232, SA or SAP options), then the 4th-pair utilization is defined by the installed daughterboard. It will not be possible to change any of the 4th-pair settings as described below.

Perform the procedure below while the transmitter is in the normal operating state (**CFG indicator is off**):

1. Press and release the **CFG** button **once** to access configuration-mode (**CFG indicator = on**).
2. Press and release the **SEL** button **twice**. You will now be able to change 4th-pair option settings.
3. LED indicators 4-6 should be illuminated (either DIM or ON); all others (indicators 1-3, 7 and 8) should be off.
4. Press the **CFG** button repeatedly to step through the available 4th-pair settings as shown below.
5. To leave configuration-mode step through all the options OR leave the buttons untouched for 10 seconds.

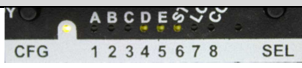
Table 12: 4th-Pair Settings

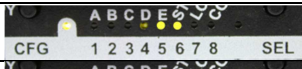
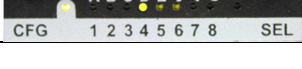
LED4	LED5	LED6	Front Panel View	4 th -Pair Operating Mode
dim	dim	dim		The 4 th -pair operating mode is defined by presence of option-module. This setting cannot be changed because an option-module is installed (232, SA or SAP). Note: If an option module is not installed, this setting will effectively “mute” the 4 th -pair signals. This can be useful sometimes for diagnostic purposes.
dim	dim	ON		Direct pass-through of 4 th -pair wires (custom applications).
dim	ON	dim		External analog (L+R summed) audio. This is the factory-default mode if no daughterboard option is installed.
dim	ON	ON		External S/PDIF digital audio. Input-impedance = 75-ohms.
ON	dim	dim		Simplex-serial.



4.6 Video Coupling Settings

The video input for the XRTx can be configured for AC coupling (with or without DC-restore function), DC coupling, or auto-detect.

Perform the procedure below while the transmitter is in the normal operating state (**CFG indicator is off**):

1. Press and release the **CFG** button twice to access configuration-mode-2 (**CFG indicator is flashing**).
2. Press and release the **SEL** button once. You will now be able to change video-coupling settings.
3. LED indicators 1-2 should be illuminated (either DIM or ON); all others (indicators 3-8) should be off.
4. Press the **CFG** button repeatedly to step through the available video-option settings as shown below.
5. To leave configuration-mode, step through all the options OR leave the buttons untouched for 10 seconds.

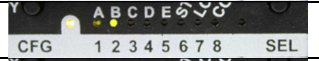
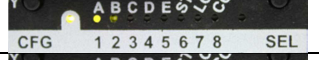
Table 13: Video Coupling Settings

LED1	LED2	Front Panel View	Video Options Mode
dim	dim		Auto-detect AC/DC coupling mode based on input signal. This is the factory-default mode.
dim	ON		Video-input is DC coupled.
ON	dim		Video-input is AC coupled, no DC-restore function.
ON	ON		Video-input is AC coupled, DC-restore function enabled.



4.7 Video Termination Settings

The input video termination can be set to 75 ohms or high-impedance (Hi-Z).

Perform the procedure below while the transmitter is in the normal operating state (**CFG indicator is off**):

1. Press and release the **CFG** button twice to access configuration-mode-2 (**CFG indicator is flashing**).
2. Press and release the **SEL** button twice. You will now be able to change video-termination settings.
3. LED indicator 3 should be illuminated (either DIM or ON); all others (indicators 1, 2, 4-8) should be off.
4. Press the **CFG** button repeatedly to toggle video termination on/off, as shown below.
5. To leave configuration-mode, step through all the options OR leave the buttons untouched for 10 seconds.

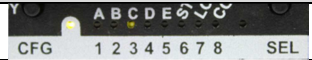
Table 14: Video Termination Settings

LED3	Front Panel View	Video Options Mode
dim		Video input impedance is Hi-Z.
ON		Video-input impedance is 75-ohms. This is the factory-default setting.

Chapter 5 Troubleshooting

In most cases, nearly every issue with the MultiView™ II CAT5 Video System can be resolved by checking the CAT5 termination and making sure that it's pinned to the TIA/EIA 568B wiring specification. However, there may be other problems that cause the system to not perform as it's designed. The following table lists the most common installation errors and their solutions.

Table 15: Troubleshooting Problems and Solutions

Problem	Solution
No video signal at the receiver	<ul style="list-style-type: none"> • Check that both units are powered. • Ensure receiver EQ and SKEW adjustments are set correctly. Change EQ settings slowly to allow the display to re-acquire a valid signal and display the image. • Make sure the CAT5 cable is terminated correctly per the TIA/EIA 568B wiring specification. • Is the display device powered on and functioning? • Check to ensure display settings (resolution, refresh rate, etc) are compatible with input signal. • In some cases, the video termination may be mismatched. Generally, transmitters and receivers ship with 75-ohm termination as the default. Refer to applicable user-guides to change the termination settings. • There may be a DDC compatibility problem. Try changing the DDC mode setting, or copying the DDC profile directly from the display.
Poor video quality at receiver	<ul style="list-style-type: none"> • Ensure receiver EQ and SKEW adjustments are set correctly. Change EQ settings slowly to allow the display to re-acquire a valid signal and display the image. • Check all cable connections. • The video signal's refresh rate may be set too high. Reset to a lower refresh rate in your display-configuration menu (for example, under Windows on a PC). • There may be a video-skew delay issue. See section on skew adjustments in the applicable receiver manual. • There may be a DDC compatibility problem. Try changing the DDC mode setting, or copying the DDC profile directly from the display.
Poor audio quality	<ul style="list-style-type: none"> • The audio output at the receiver is line-level only. An amplifier or powered speakers are required. Make sure amplifier or speaker power is ON. • Check input source levels from the source device. Ensure the audio source level does not exceed the audio-input ratings for the XRTx. Clipping or distortion can result. • Audio is summed left and right for "A" versions. If using a single channel, both audio inputs must be connected at the transmitter end to obtain proper audio gain through the link (1:1, input to output). • If daisy chaining, audio termination must be removed in DP receivers (AK600/1200DP and XR2000DP). Only the last receiver requires termination. This does not apply to SA or SAP units. SA units no longer require separate daisy chain or end of line units as of April 2009. <i>Refer to the appropriate receiver user manual.</i>
Serial communication doesn't work correctly	<ul style="list-style-type: none"> • Are the serial devices connected properly? Are the serial parameters correct for source/destination devices? • Are the serial cables terminated correctly? Is a null-modem cable required at the TX or RX end? • When using RS-232 capable receivers with video switches, distribution amps, or multi-output transmitters, the serial data is sent transmit-only. Please take this into account when trying to control displays or other devices. <i>For assistance, contact Magenta Technical Support.</i>
Notes on daisy chaining	<p>When utilizing a receiver's RJ45 daisy chain port, the following rules apply:</p> <ul style="list-style-type: none"> • If using L/R summed audio, simplex serial, or SPDIF units, a maximum of 12 units may be daisy chained within the rated cable length of the receiver. • When using SA units, a maximum of 4 units may be daisy chained within the rated cable length of the receiver.

Problem	Solution
	<ul style="list-style-type: none"> • When using SAP units, a maximum of 12 units may be daisy chained within the rated cable length of the receiver if using standard CAT5/6 or a maximum of 8 units may be daisy chained within the rated cable length of the receiver if using low-skew cable. • When daisy chaining, the maximum cable distance is not increased beyond the rated distance of the receiver used. For example, an AK600 can only daisy chain within 600 ft of the transmitter. It is possible to daisy chain out of a short range receiver into a longer range receiver to increase the range. For example, over 600 ft an AK600 can be daisy chained into an AK1200 which allows for daisy chaining to 1,200 ft.

Appendix A Connector Pinouts

Serial port (IOIO) Connector Pinout (232/SA/SAP versions only)

The XRTx's serial port connector is configured to look like a standard 9-pin "DCE" serial port. Therefore, in most applications a straight through serial cable or adapter-plug (DB9-Female-to-Male) is used to connect an external serial device (for example, a PC) to the XRTx transmitter.

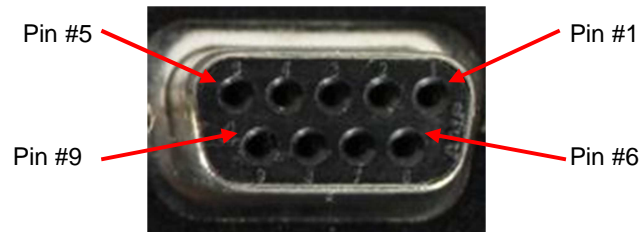

Figure 4: DB9-F Serial Port



The DB9-F serial port is only available on XRTx-232, -SA and -SAP models.

Table 16: DB9-F Pins

	XRT (232) Simplex	XRTx (232) Duplex	XRTx (SA) Simplex	XRTx (SA) Duplex	XRTx (SAP) Simplex	XRTx (SAP) Duplex
Pin#	4 wire	9 wire	2 wire	3 wire	2 wire	3 wire
1	-	DCD	-	-	-	-
2	-	RX	-	RX	-	RX
3	TX	TX	TX	TX	TX	TX
4	DTR	DTR	-	-	-	-
5	Ground	Ground	Ground	Ground	Ground	Ground
6	-	DSR	-	-	-	-
7	RTS	RTS	-	-	-	-
8	-	CTS	-	-	-	-
9	-	RI	-	-	-	-

Auxiliary I/O (AUX-I/O) Connector Pinout

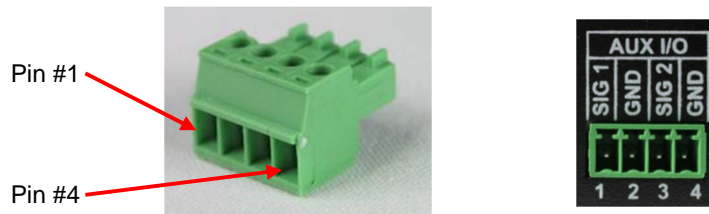

Figure 5: 4-pin Phoenix Connector Pinout

Table 17: 4-pin Phoenix Pins

PIN#	XRTx				XRTx-232	XRTx-SA	XRTx-SAP
	(A) Audio	(S) Simplex Serial	SPDIF Audio	Composite Video	-	SA Audio*	SAP Audio
1 (SIG1)	Left Channel	Tx	Signal +	Signal +	-	Left Channel	Left Channel
2 (GND)	Ground	ground	Signal -	Signal -	-	Ground	Ground
3 (SIG2)	Right Channel	-	-	-	-	Right Channel	Right Channel
4 (GND)	-	Shell	-	-	-	-	-

* **Note:** SA audio channels are reversed at the MultiView™ or MultiView™ II receiver end! Left audio is on pin 3 and right audio is on pin 1.

DC Power Connector

Magenta provides ready-to-use power supplies for MultiView™ II products. However, if there is a reason a substitute power supply must be used, then the following information is important for maintaining product reliability and performance:

Magenta AC/DC Power supply output rating: Regulated +5VDC @ 3Amps.

Power-input rating for MultiView™ II XRTx: 5VDC, 1.2Amps max.

The XRTx's DC power input connector accepts an industry-standard coaxial-DC plug with the following specifications:

- Coaxial power connector
- OD = 5.5mm
- ID = 2.5mm (accepted center-pin diameter)
- Length = 11mm (overall length of insertable plug end)
- Inner contact (pin-socket) = +5VDC
- Outer contact (sleeve) = Ground

It is highly recommended that the inner contact (center-pin contact) of any mating DC plug utilize a “tuning-fork” shaped design, rather than a plain barrel shape. The tuning-fork design greatly increases the reliability of the power connection. The plain barrel style connector can cause intermittent operation, often resulting in “mysterious” system problems that are difficult to identify.

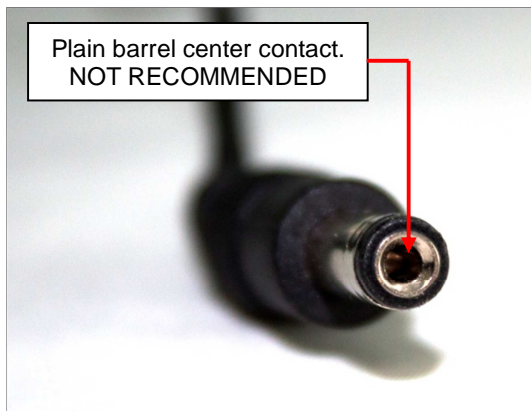

Figure 6: Plain Barrel Connector

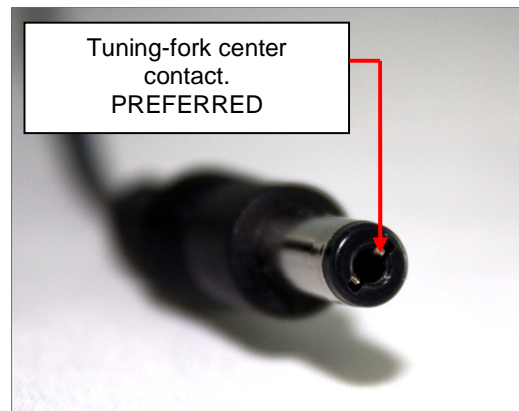

Figure 7: Tuning-fork Connector



The Magenta-provided power supply already comes with the correct output ratings and DC-plug configuration

RJ45 (MultiView Link) Wiring Standard

T568B CAT5 Specification

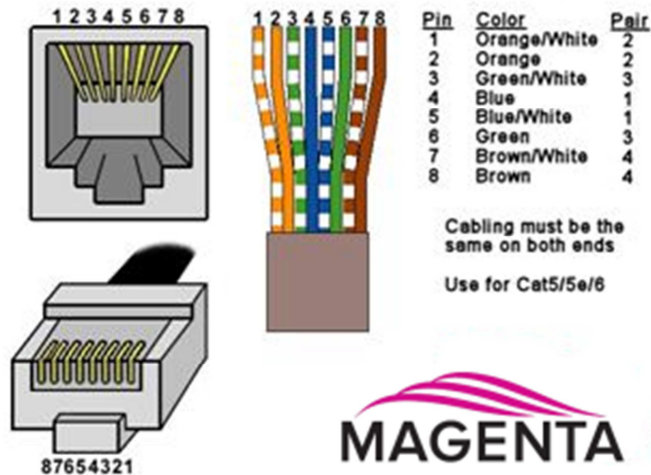

Figure 8: T568B CAT5

Table 18: T568B CAT5 Pins

PIN #	COLOR	PAIR
1	White / Orange Stripe	2
2	Orange Solid	2
3	White / Green Stripe	3
4	Blue Solid	1
5	White / Blue Stripe	1
6	Green Solid	3
7	White / Brown Stripe	4
8	Brown Solid	4

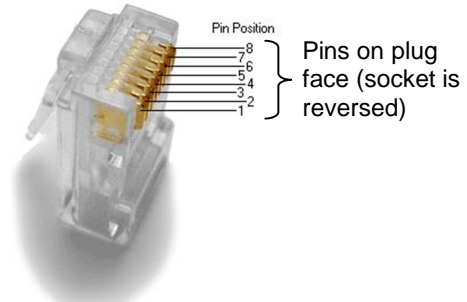

Figure 9: Typical RJ-45 Plug

VGA Input/Output (optional) Connector Pinout

The XRTx's VGA port connectors are standard HD-15 female connectors (three-row, 15-pin).

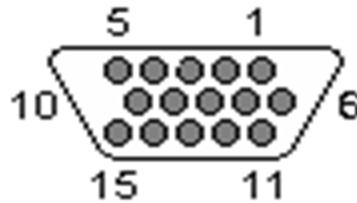

Figure 10: HD-15 Female Connector

Table 19: HD-15 Connector Pins

Pin	RGBHV	RGBS	RGsB	Com-	SVHS	YUV
1	Red +	Red +	Red +		C+	V+
2	Green+	Green+	Green+	C+	Y+	Y+
3	Blue+	Blue+	Blue+			U+
4	—	—	—			
5	Gnd	Gnd	Gnd			
6	Red-	Red-	Red-		C-	V-
7	Green-	Green-	Green-	C-	Y-	Y-
8	Blue-	Blue-	Blue-			U-
9	—	—	—			
10	Gnd	Gnd	—			
11	Gnd	Gnd	—			
12	—	—	—			
13	H Sync	C Sync	—			
14	V Sync	—	—			
15	Gnd	Gnd	—			

Appendix B Option Module Settings: XRTx-232

The (232) option module has internal jumper settings that can be configured for various serial modes and CAT5 cable lengths.

To access the (232) module board:

1. Make sure the unit is powered OFF.
2. If necessary, unplug all cables to the unit.
3. Unscrew the top cover screws.
4. Unscrew the DB9-F hex-standoffs.
5. Lift the cover off.
6. Carefully unplug the (232) module from the main board.

Table 20: Transmitter (232) Module Jumper Settings

Mode	Type	Baud (Max)	JP1 1-2	JP1 3-4
1	Simplex (one way) (to 1500 ft)	115k	OUT	IN
2	Full Duplex (2 way) Short (< 500 ft)	19.2K	OUT	OUT
3/5 Default Setting	Full Duplex (2 way) Long (to 1500 ft)	19.2k	IN	OUT
4	Half Duplex (2 way) Long (to 1500 ft)	115k	IN	IN

Notes:

- Mode 1 is required when using multi output transmitters and when daisy chaining receivers.
- Mode 3 may introduce noise in video over 1,000 ft when serial communication occurs. This does not apply if Mode 5 is used on the receiver.
- JP1 5-6 & 7-8 terminate the serial bus and must be IN on the transmitter.

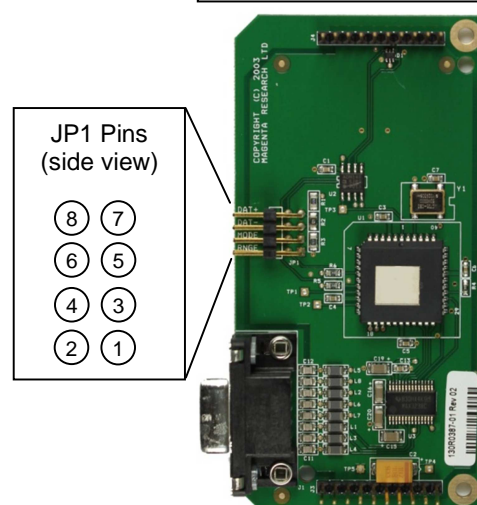
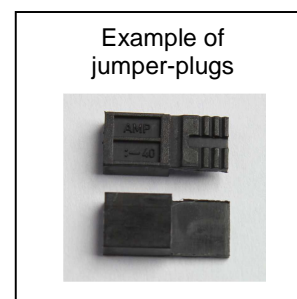
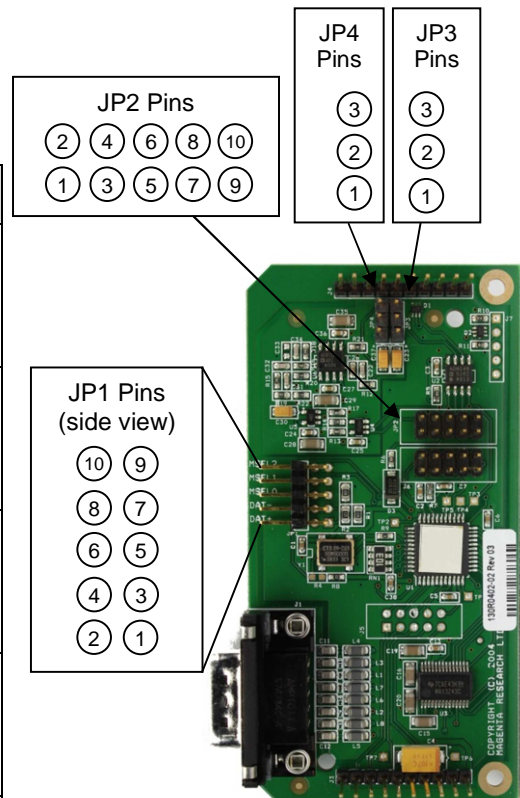

Figure 11: Transmitter (232) Module Board

Table 21: Receiver (232) Module Jumper Settings

Mode	Type	Baud (Max)	JP1	JP2
1	Simplex (one way) (to 1500 ft)	115k	1-2 See Notes 3-4 See Notes 5-6 IN 7-8 OUT 9-10 OUT	1-2 IN 3-4 OUT 5-6 OUT 7-8 OUT 9-10 IN
2	Full Duplex (2 way) Short (< 500 ft)	19.2k	1-2 See Notes 3-4 See Notes 5-6 OUT 7-8 OUT 9-10 OUT	1-2 IN 3-4 OUT 5-6 OUT 7-8 IN 9-10 OUT
3	Full Duplex (2 way) Long (to 1000 ft)	19.2k	1-2 See Notes 3-4 See Notes 5-6 OUT 7-8 IN 9-10 OUT	1-2 IN 3-4 OUT 5-6 OUT 7-8 IN 9-10 OUT
4	Half Duplex (2 way) Long (to 1500 ft)	115k	1-2 See Notes 3-4 See Notes 5-6 IN 7-8 IN 9-10 OUT	1-2 IN 3-4 OUT 5-6 OUT 7-8 IN 9-10 OUT
5 Default	Full Duplex (2 way) Long (to 1500 ft)	19.2k	1-2 OUT 3-4 OUT 5-6 OUT 7-8 IN 9-10 OUT	1-2 OUT 3-4 IN 5-6 IN 7-8 OUT 9-10 IN

**Figure 12: Receiver (232) Module Board**

*JP3 and JP4 are OUT for all models except MODE 5.
In MODE 5, JP3 & JP4 should be jumpered across pins 2-3

Notes:

- Mode 1 is required when using multi output transmitters and when daisy chaining receivers.
- Mode 3 may introduce noise in video over 1,000 ft when serial communication occurs.
- JP1 1-2 and 3-4 terminate the serial bus and must be IN on the last receiver in a daisy chain or if using a point to point link UNLESS using Mode 5.

Appendix C Option Module Settings: XRTx-SAP

The SAP option module allows a bi-directional session to be established between a SAP-equipped transmitter (XRTx-SAP), and a specific SAP-equipped receiver even in a multiple-receiver daisy chain installation.

The SAP transmitter devices (XRTx-SAP for example) do not have address DIP-switches. The factory-default address of the transmitter is “0”.

The SAP receiver devices (AK600-SAP for example) have address DIP-switches.

Each SAP-equipped receiver must have a unique address set first, via DIP-switch settings or by a serial command entered directly at the receiver.

Once this has been done, a special “set destination address” command is sent into the transmitter to specify which receiver to open a session with.

If the XRTx-SAP is commanded to use destination address 0 (zero), serial data will be broadcast to all receivers. This is the factory-default behavior.

To set the SAP receiver’s address switches, you will need to open the **receiver** enclosure and set the DIP-switches directly on the SAP module. The DIP-switch has 8 switches, one for each address bit position. Use the SAP addressing chart provided on the next page to determine the proper switch addresses.

All receivers must have a unique address. *It is recommended to write the address on each receiver once this step has been completed.* It is also recommended to keep a list of receiver addresses and locations to make it easier to determine which receiver/display is desired to communicate with.

To set SAP address DIP-switches (at SAP-receiver units):

1. Remove the top cover assembly of the receiver.
2. Locate the 8 position dipswitch on the internal daughterboard assembly and using the SAP-addressing chart, set the receiver address as needed.

Figure 13: Internal Daughterboard Assembly with 8 Position Dipswitch

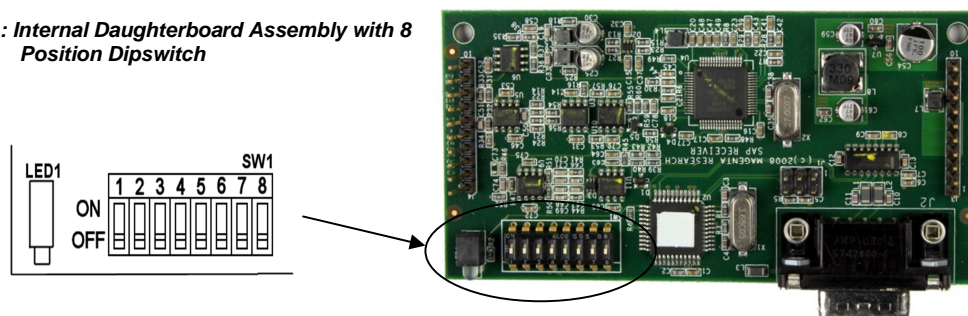

3. Replace cover assembly and install unit.

Note: It is also possible to set a SAP receiver’s address by a **serial-command** entered at the receiver itself. In this case, simply ensure all DIP switches are set to address 0 (zero).

Please also refer to the *SAP II Programmer’s Guide* for additional information on SAP related settings and operation.

SAP Addressing Chart

ADDR	Switch Settings								
00	1	2	3	4	5	6	7	8	ON OFF
01	1								ON OFF
02	1	2							ON OFF
03	1	2							ON OFF
04	1	2	3						ON OFF
05	1	2	3	4	5	6	7	8	ON OFF
06	1	2	3						ON OFF
07	1	2	3	4	5	6	7	8	ON OFF
08	1	2	3	4					ON OFF
09	1	2	3	4	5	6	7	8	ON OFF
10	1	2	3	4					ON OFF
11	1	2	3	4	5	6	7	8	ON OFF
12	1	2	3	4					ON OFF
13	1	2	3	4	5	6	7	8	ON OFF
14	1	2	3	4					ON OFF
15	1	2	3	4	5	6	7	8	ON OFF
16	1	2	3	4	5				ON OFF
17	1	2	3	4	5	6	7	8	ON OFF
18	1	2	3	4	5				ON OFF
19	1	2	3	4	5	6	7	8	ON OFF
20	1	2	3	4	5	6	7	8	ON OFF
21	1	2	3	4	5				ON OFF
22	1	2	3	4	5	6	7	8	ON OFF
23	1	2	3	4	5				ON OFF
24	1	2	3	4	5	6	7	8	ON OFF
25	1	2	3	4	5	6	7	8	ON OFF
26	1	2	3	4	5	6	7	8	ON OFF
27	1	2	3	4	5	6	7	8	ON OFF
28	1	2	3	4	5	6	7	8	ON OFF
29	1	2	3	4	5				ON OFF
30	1	2	3	4	5	6	7	8	ON OFF
31	1	2	3	4	5	6	7	8	ON OFF

ADDR	Switch Settings								
32	1	2	3	4	5	6	7	8	ON OFF
33	1	2	3	4	5	6	7	8	ON OFF
34	1	2	3	4	5	6	7	8	ON OFF
35	1	2	3	4	5	6	7	8	ON OFF
36	1	2	3	4	5	6	7	8	ON OFF
37	1	2	3	4	5	6	7	8	ON OFF
38	1	2	3	4	5	6	7	8	ON OFF
39	1	2	3	4	5	6	7	8	ON OFF
40	1	2	3	4	5	6	7	8	ON OFF
41	1	2	3	4	5	6	7	8	ON OFF
42	1	2	3	4	5	6	7	8	ON OFF
43	1	2	3	4	5	6	7	8	ON OFF
44	1	2	3	4	5	6	7	8	ON OFF
45	1	2	3	4	5	6	7	8	ON OFF
46	1	2	3	4	5	6	7	8	ON OFF
47	1	2	3	4	5	6	7	8	ON OFF
48	1	2	3	4	5	6	7	8	ON OFF
49	1	2	3	4	5	6	7	8	ON OFF
50	1	2	3	4	5	6	7	8	ON OFF
51	1	2	3	4	5	6	7	8	ON OFF
52	1	2	3	4	5	6	7	8	ON OFF
53	1	2	3	4	5	6	7	8	ON OFF
54	1	2	3	4	5	6	7	8	ON OFF
55	1	2	3	4	5	6	7	8	ON OFF
56	1	2	3	4	5	6	7	8	ON OFF
57	1	2	3	4	5	6	7	8	ON OFF
58	1	2	3	4	5	6	7	8	ON OFF
59	1	2	3	4	5	6	7	8	ON OFF
60	1	2	3	4	5	6	7	8	ON OFF
61	1	2	3	4	5	6	7	8	ON OFF
62	1	2	3	4	5	6	7	8	ON OFF
63	1	2	3	4	5	6	7	8	ON OFF



ADDR	Switch Settings								
64	1	2	3	4	5	6	7	8	ON OFF
65	1	2	3	4	5	6	7	8	ON OFF
66	1	2	3	4	5	6	7	8	ON OFF
67	1	2	3	4	5	6	7	8	ON OFF
68	1	2	3	4	5	6	7	8	ON OFF
69	1	2	3	4	5	6	7	8	ON OFF
70	1	2	3	4	5	6	7	8	ON OFF
71	1	2	3	4	5	6	7	8	ON OFF
72	1	2	3	4	5	6	7	8	ON OFF
73	1	2	3	4	5	6	7	8	ON OFF
74	1	2	3	4	5	6	7	8	ON OFF
75	1	2	3	4	5	6	7	8	ON OFF
76	1	2	3	4	5	6	7	8	ON OFF
77	1	2	3	4	5	6	7	8	ON OFF
78	1	2	3	4	5	6	7	8	ON OFF
79	1	2	3	4	5	6	7	8	ON OFF
80	1	2	3	4	5	6	7	8	ON OFF
81	1	2	3	4	5	6	7	8	ON OFF
82	1	2	3	4	5	6	7	8	ON OFF
83	1	2	3	4	5	6	7	8	ON OFF
84	1	2	3	4	5	6	7	8	ON OFF
85	1	2	3	4	5	6	7	8	ON OFF
86	1	2	3	4	5	6	7	8	ON OFF
87	1	2	3	4	5	6	7	8	ON OFF
88	1	2	3	4	5	6	7	8	ON OFF
89	1	2	3	4	5	6	7	8	ON OFF
90	1	2	3	4	5	6	7	8	ON OFF
91	1	2	3	4	5	6	7	8	ON OFF
92	1	2	3	4	5	6	7	8	ON OFF
93	1	2	3	4	5	6	7	8	ON OFF
94	1	2	3	4	5	6	7	8	ON OFF
95	1	2	3	4	5	6	7	8	ON OFF

ADDR	Switch Settings								
96	1	2	3	4	5	6	7	8	ON OFF
97	1	2	3	4	5	6	7	8	ON OFF
98	1	2	3	4	5	6	7	8	ON OFF
99	1	2	3	4	5	6	7	8	ON OFF
100	1	2	3	4	5	6	7	8	ON OFF
101	1	2	3	4	5	6	7	8	ON OFF
102	1	2	3	4	5	6	7	8	ON OFF
103	1	2	3	4	5	6	7	8	ON OFF
104	1	2	3	4	5	6	7	8	ON OFF
105	1	2	3	4	5	6	7	8	ON OFF
106	1	2	3	4	5	6	7	8	ON OFF
107	1	2	3	4	5	6	7	8	ON OFF
108	1	2	3	4	5	6	7	8	ON OFF
109	1	2	3	4	5	6	7	8	ON OFF
110	1	2	3	4	5	6	7	8	ON OFF
111	1	2	3	4	5	6	7	8	ON OFF
112	1	2	3	4	5	6	7	8	ON OFF
113	1	2	3	4	5	6	7	8	ON OFF
114	1	2	3	4	5	6	7	8	ON OFF
115	1	2	3	4	5	6	7	8	ON OFF
116	1	2	3	4	5	6	7	8	ON OFF
117	1	2	3	4	5	6	7	8	ON OFF
118	1	2	3	4	5	6	7	8	ON OFF
119	1	2	3	4	5	6	7	8	ON OFF
120	1	2	3	4	5	6	7	8	ON OFF
121	1	2	3	4	5	6	7	8	ON OFF
122	1	2	3	4	5	6	7	8	ON OFF
123	1	2	3	4	5	6	7	8	ON OFF
124	1	2	3	4	5	6	7	8	ON OFF
125	1	2	3	4	5	6	7	8	ON OFF
126	1	2	3	4	5	6	7	8	ON OFF
127	1	2	3	4	5	6	7	8	ON OFF

Appendix D Mounting Kits

The following table shows several kits available for mounting the XRTx.

Table 22: XRTx Mounting Kits

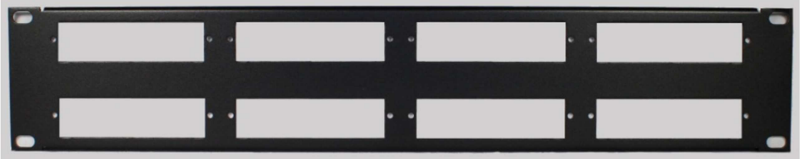
Mounting Kit #	Description	
2211053-01	Rigid-mount bracket. This mounts a single device to a surface (wall/desk/etc.). Comes with 4 self-tapping screws.	
8310207-02	1U Rack-mount Plate for standard 19" rack. Mounts 4 devices in a 1U space. Comes with (8) device-mounting screws, (4) rack-mounting screws.	
8310208-02	2U Rack-mount Plate for standard 19" rack. Mounts 8 devices in a 2U space. Comes with (16) device-mounting screws, (4) rack-mounting screws.	

Note: When installing XRTx devices in an area susceptible to elevated operating temperatures (near the maximum specified operating temperature), it is important to give careful consideration to maintaining adequate air flow. Within a rack assembly, cable bundles and other equipment in the same rack can impede proper cooling. In some rack-mount applications you may even need to leave a 1U gap (using a blank filler plate) between XRTx groups. For surface-mount applications, ensure the device will have adequate air circulation and that air-vents on the enclosure are not blocked.



Figure 14: XRTx with Rigid Mount Bracket



Figure 16: XRTx with 1U Rack-mount Plate



Figure 15: XRTx with 2U Rack-mount Plate

Appendix E System Design Drawings

The following drawings are available from Magenta Research as an aid in system design and configuration. You may download them from the Magenta website (www.magenta-research.com). There is no charge for obtaining these drawings.

Table 23: MultiView™ II XRTx Drawings

Drawing #	Description
2500132-01	MultiView™ II XRTx Sales Drawing (.dwg and .pdf format)
2510002-01	MultiView™ II XRTx Autocad Symbols (.dwg and .pdf format)

Appendix F Regulatory Compliance Information

FEDERAL COMMUNICATIONS COMMISSION AND INDUSTRY CANADA RADIO FREQUENCY INTERFERENCE STATEMENTS

This device complies with part 15 of the FCC Rules. Operation is subject to the following two conditions: 1) This device may not cause harmful interference, and 2) this device must accept any interference received, including interference that may cause undesired operation.

This equipment has been tested and found to comply with the limits for a Class A digital device, pursuant to part 15 of the FCC Rules. These limits are designed to provide reasonable protection against harmful interference when the equipment is operated in a commercial environment. This equipment generates, uses, and can radiate radio frequency energy and, if not installed and used in accordance with the instruction manual, may cause harmful interference to radio communications. Operation of this equipment in a residential area is likely to cause harmful interference in which case the user will be required to correct the interference at his/her own expense.

Canada (ICES-003) notice: This Class A digital apparatus complies with Canadian ICES-003.

Cet appareil numérique de la classe A est conforme à la norme NMB-003 du Canada.

EUROPEAN UNION DECLARATION OF CONFORMITY

Warning: This is a Class A product. In a domestic environment this product may cause radio interference in which case the user may be required to take adequate measures.

Magenta Research (New Milford CT USA) declares under our sole responsibility that the **Magenta MultiView™ and Multiview™ II** video-extension products to which this declaration relates is in conformity with the following standard(s) or other normative documents:

- EN55022:2006 + A1:2007 Class A ITE emissions requirements.
- EN61000-3-2:2006 Limits for harmonic current emissions (equipment input current up to and including 16A per phase).
- EN61000-3-3:1995/A1:2001/A2:2005 Limitation of voltage fluctuations and flicker on low-voltage supply systems for equipment with rated current up to and including 16A.
- EN55024:2003 Immunity for ITE.

SAFETY WARNING

Connection: Not for direct connection to Telecommunication Network Circuitry (TNV)

Power sources: This equipment should be operated only from the power source indicated on the product. Disconnect all power sources before servicing.

Servicing: Refer all servicing to qualified service personnel. There are no user-serviceable parts inside.

Slots and openings: If the equipment has slots or holes in the enclosure, these are provided to prevent overheating of sensitive components inside. These openings must never be blocked by other objects or equipment.

INDEX

- About this manual, 1
- Configuration
 - 4th-pair modes, 16
 - DDC modes, 14
 - factory defaults, 13
 - general modes, 13
 - sync modes, 15
 - video coupling modes, 17
 - video termination modes, 17
- Contact information, iv
- Default settings, 13
- Drawings, 32
- Front panel interfaces, 2
- Installation
 - CAT5 pinout, 10
 - overview, 10
 - prerequisites, 10
 - procedure, 11
- Mounting kits, 30
- Option module settings
 - 232 option module, 25
 - SAP option module, 27
- Pinouts
 - auxiliary signal port, 21
 - Phoenix connector, 21
 - power connector, 22
 - serial port, 20
 - UTP/CAT5 link port, 23
- Precautions, iii
- Product overview, 2
- Rear panel interfaces, 2
- Regulatory information, 33
- Reset to factory defaults, 13
- SAP addresses, 28
- Serial addressing, 27
- Specifications
 - auxiliary signals, 6
 - CAT5 cables, 8
 - DDC support, 5
 - general, 3
 - VGA interface, 4
- System design drawings, 32
- Troubleshooting, 18
- XRTx versions
 - overview, 6
 - XRTx-232, 7
 - XRTx-S, 6
 - XRTx-SA, 7
 - XRTx-SAP, 8
 - XTRx-A, 6