



Middle Atlantic Products

EXCEPTIONAL SUPPORT & PROTECTION™

BRK/MBRK/OBRK/RK/SRK/OSR Laminate Racks



EIA/TIA Compliant

The BRK/MBRK/OBRK/RK/SRK/OSR Series 19" Equipment Racks

Features

- High quality equipment rack features an oak, maple or black wood grain finish
- 5/8" or 3/4" furniture grade MDF board construction (depending on model)
- Four depths available to accommodate any permanent installation
- Assembles easily with included hardware
- Rear access panel available for 22" and 28" deep models



RK/BRK/MBRK



SRK



OBRK



OSR

Architects' and Engineers' Specifications

RK/BRK/OBRK/MBRK

EIA compliant Wooden Studio Rack shall be Middle Atlantic Products model # __RK__ (refer to chart). __RK__ shall have __ useable rackspaces with a __" overall height (refer to chart). __RK__ shall have a __" depth. Studio rack shall be constructed of __" furniture grade MDF board and shall feature a high quality __ wood grain laminate finish (refer to chart). Rackrail shall be equipped with one set of 11-gauge steel with tapped 10-32 holes in universal EIA spacing (2 sets included for racks with 22" and 28" depths). Assembly hardware shall be 1/4 turn bolts with 1/4 turn cams for MBRK, 22" and 28" deep racks. Other models use joint connector screws. Studio rack shall be rated to __lb. weight capacity. Studio Rack shall be GREENGUARD Indoor Air Quality Certified for Children and Schools. Studio Rack shall be RoHS EU Directive 2002/95/EC compliant. Studio rack shall be manufactured by an ISO 9001 and ISO 14001 registered company. Studio rack shall be warranted to be free from defects in material or workmanship under normal use and conditions for a period of 7 years.

SRK

EIA compliant Sloped Rolling Equipment Rack shall be Middle Atlantic Products model # SRK. Equipment rack shall provide a 16 rackspace lower bay and an upper 12 rackspace bay sloped back at a 25° angle. SRK shall be constructed of 5/8" furniture grade MDF board and shall feature a high quality black wood grain laminate finish. Pre-installed rackrail shall be 11-gauge steel with tapped 10-32 holes in universal EIA spacing. Assembly hardware shall be 2-1/4" joint connector screws. A hex key shall be included for assembly. Black plastic screw caps shall snap into place to cover the included hardware. Studio rack shall be rated to 200 lb. weight capacity. Studio rack includes four pre-installed casters. Studio rack shall be rated to 200 lb. weight capacity. Studio Rack shall be GREENGUARD Indoor Air Quality Certified for Children and Schools. Studio Rack shall be RoHS EU Directive 2002/95/EC compliant. Studio rack shall be manufactured by an ISO 9001 and ISO 14001 registered company. Studio rack shall be warranted to be free from defects in material or workmanship under normal use and conditions for a period of 7 years.

OSR

EIA compliant Sloped Rolling Equipment Rack shall be Middle Atlantic Products model # OSR-__ (refer to chart). Equipment rack shall provide a __ rackspaces (refer to chart) sloped at __° (refer to chart). OSR shall be constructed of 3/4" furniture grade MDF board and shall feature a high quality Oak laminate finish. Pre-installed rackrail shall be 11-gauge steel with tapped 10-32 holes in universal EIA spacing. Assembly hardware shall be 2-1/4" joint connector screws. A hex key shall be included for assembly. Black plastic screw caps shall snap into place to cover the included hardware. Studio rack shall be rated to 200 lb. weight capacity. Studio rack includes four pre-installed casters. Studio Rack shall be GREENGUARD Indoor Air Quality Certified for Children and Schools. Studio Rack shall be RoHS EU Directive 2002/95/EC compliant. Studio rack shall be manufactured by an ISO 9001 and ISO 14001 registered company. Studio rack shall be warranted to be free from defects in material or workmanship under normal use and conditions for a period of 7 years.

OPTIONS (OBRK, BRK and RK)

- Set of four casters shall be model # RKW. RKW shall have a 150 lb. weight capacity.
- Set of 4 heavy duty casters shall be model # RKW-HD. RKW-HD shall have a weight capacity of 250 lbs.
- Additional set of rear rackrail, shall be model # RK-RRX (X = total # of rackspaces)

OPTIONS

- Smoked glass front door shall be model # RK-GD __ (6, 8, 10, 12, 14, 16, 20, 28) for __ rackspace (M), (O), (B)RK rack
- Quick-Position™ shelf with built-in cable management slots shall be model # SH-BRK. Shelf mounts without rackrail for OBRK/BRK and MBRK-18" depth and accepts horizontal mounting of PD-8155C or PD-8155C-NS power strip

OPTIONS (BRK, MBRK 22" and 28" DEPTHS)

- Rear access panel shall be Middle Atlantic Products model # __ (refer to chart). Rear access panel shall have an overall height of __ (refer to chart). Rear access panel shall include a 2-space top vented panel and a 2-space cable management panel.
- Fan kit shall be Middle Atlantic Products model # DCFANKIT-4 (110V), or IDCFANKIT-4 (220V). Fans shall displace 100 CFM of free air and replaces vented panel on rear access panel. Fan kit works with rear access panel.

CUSTOMIZABLE SPECIFICATION CLIPS AVAILABLE AT MIDDLEATLANTIC.COM

SRK basic dimensions

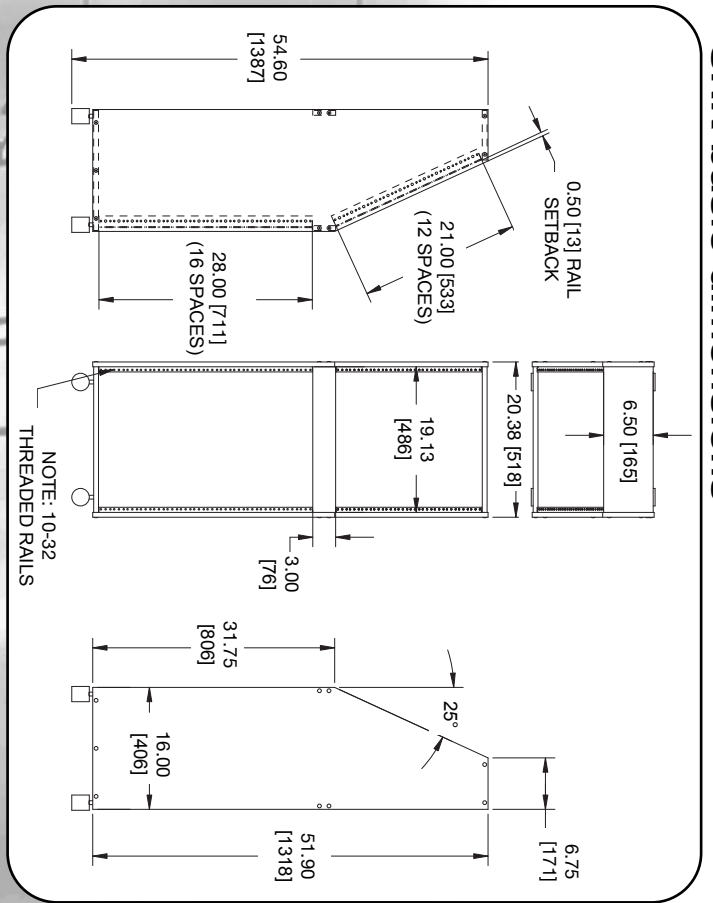

RK/BRK/OBRK/MBRK/MBRK basic dimensions

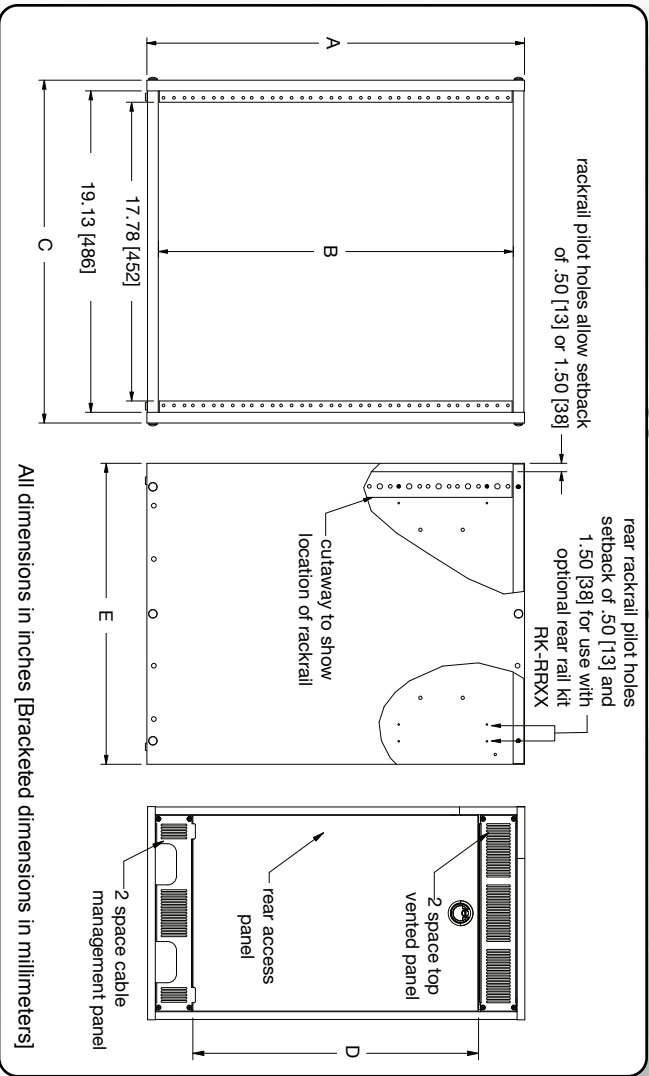

Model Number	A Overall Height	B Racking Height	C Outside Width	E Overall Depth	Weight Capacity
RK2	4.98 (126)	3.50 (89)	20.40 (518)	15.91 (404)	200 lbs.
RK4	8.48 (215)	7.00 (178)	20.40 (518)	15.91 (404)	200 lbs.
RK6	11.98 (304)	10.50 (267)	20.40 (518)	15.91 (404)	200 lbs.
RK8	15.48 (393)	14.00 (356)	20.40 (518)	15.91 (404)	200 lbs.
RK10	18.98 (482)	17.50 (445)	20.40 (518)	15.91 (404)	200 lbs.
RK12	22.48 (571)	21.00 (533)	20.40 (518)	15.91 (404)	200 lbs.
RK14	25.98 (660)	24.50 (622)	20.40 (518)	15.91 (404)	200 lbs.
RK16	29.48 (749)	28.00 (711)	20.40 (518)	15.91 (404)	200 lbs.
RK20	36.48 (927)	35.00 (889)	20.40 (518)	15.91 (404)	200 lbs.
BRK6	11.98 (304)	10.50 (267)	20.40 (518)	17.91 (455)	200 lbs.
BRK8	15.48 (393)	14.00 (356)	20.40 (518)	17.91 (455)	200 lbs.
BRK10	18.98 (482)	17.50 (445)	20.40 (518)	17.91 (455)	200 lbs.
BRK12	22.48 (571)	21.00 (533)	20.40 (518)	17.91 (455)	200 lbs.
BRK14	25.98 (660)	24.50 (622)	20.40 (518)	17.91 (455)	200 lbs.
BRK16	29.48 (749)	28.00 (711)	20.40 (518)	17.91 (455)	200 lbs.
BRK20	36.48 (927)	35.00 (889)	20.40 (518)	17.91 (455)	200 lbs.
OBRK8	15.63 (397)	14.00 (356)	20.70 (526)	17.91 (455)	200 lbs.
OBRK12	22.63 (575)	21.00 (533)	20.70 (526)	17.91 (455)	200 lbs.
OBRK16	29.63 (753)	28.00 (711)	20.70 (526)	17.91 (455)	200 lbs.
OBRK20	36.63 (930)	35.00 (889)	20.70 (526)	17.91 (455)	200 lbs.
MBRK8	15.63 (397)	14.00 (356)	20.70 (526)	17.91 (455)	200 lbs.
MBRK12	22.63 (575)	21.00 (533)	20.70 (526)	17.91 (455)	200 lbs.
MBRK16	29.63 (753)	28.00 (711)	20.70 (526)	17.91 (455)	200 lbs.
MBRK20	36.63 (930)	35.00 (889)	20.70 (526)	17.91 (455)	200 lbs.
(M)BRK8-22	15.63 (397)	14.00 (356)	20.70 (526)	22.00 (559)	200 lbs.
(M)BRK12-22	22.63 (575)	21.00 (533)	20.70 (526)	22.00 (559)	200 lbs.
(M)BRK16-22	29.63 (753)	28.00 (711)	20.70 (526)	22.00 (559)	200 lbs.
(M)BRK20-22	36.63 (930)	35.00 (889)	20.70 (526)	22.00 (559)	200 lbs.
(M)BRK28-22	50.63 (1286)	49.00 (1245)	20.70 (526)	28.00 (711)	250 lbs.

RK and BRK (18" depths) racks are constructed of 5/8" furniture grade MDF board construction.
BRK (22" and 28" depths), MBRK and OBRK racks are constructed of 3/4" furniture grade, MDF board construction.

Model Number	D Rear Access Panel
RK-RAPI(-MP)	6.78 (172)
RK-RAPI2(-MP)	13.78 (350)
RK-RAPI6(-MP)	20.78 (528)
RK-RAPI20(-MP)	27.78 (706)
RK-RAPI28(-MP)	41.78 (1062)

Model	Color
RK	Black
OBRK	Oak
MBRK	Maple
BRK	Black
SRK	Black



OSR basic dimensions

All dimensions in inches [Bracketed dimensions in millimeters]

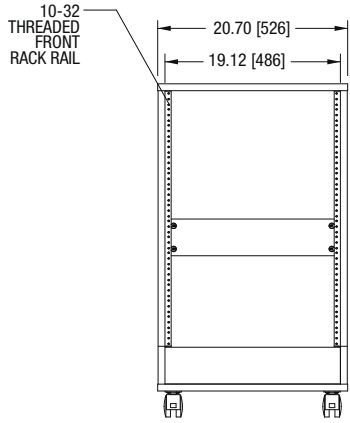

FRONT VIEW

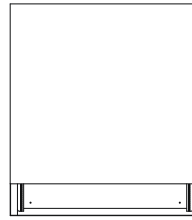

TOP VIEW

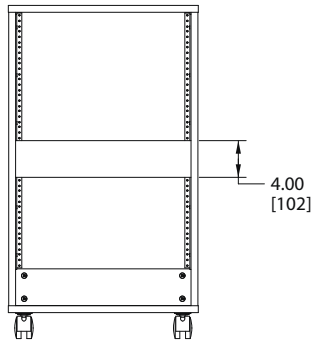
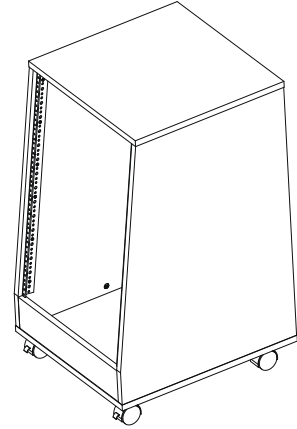

REAR VIEW

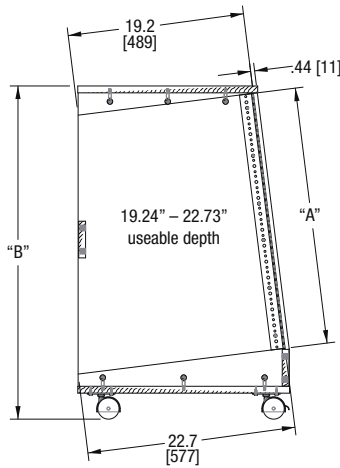

LEFT SIDE VIEW

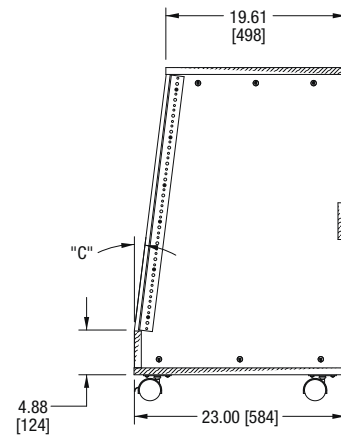

RIGHT SIDE VIEW

Model Number	Racking Height	"A"	"B" Overall Height	"C" Angle
OSR-16	16 Space	28.00 [711]	36.37 [924]	7°
OSR-24	24 Space	42.00 [1067]	50.37 [1279]	5°

