

SS Series

sliding shelves

Sliding shelves allow for easy maintenance of your components right on the shelf, and access to connections and cabling from the front of the rack.

features:

SS

- All steel construction
- Full extension ball bearing slides extend 13"
- Telescopic rear support
- Shelf area 17-1/2" wide by 14-1/8" deep
- UL listed in the US and Canada



SS

SSL

- Nylon roller slides extend 10"
- Occupies one rackspace
- Telescopic rear support
- Made with an attractive black laminate material
- Shelf area 16" wide by 13-3/4" deep
- UL listed in the US and Canada



SSL

specifications:

SS: EIA/TIA compliant sliding shelf shall be Middle Atlantic Products model # SS. SS shall be constructed of steel. Full-extension, ball-bearing slides shall extend 13". Shelf area shall be 17.48" W x 14.21"D. Maximum weight capacity shall be 50 lbs. SS shall be UL Listed in the US and Canada. Sliding shelf shall be RoHS EU Directive 2002/95/EC compliant. Sliding shelf shall be manufactured by an ISO 9001 and ISO 14001 registered company. Sliding shelf shall be warrantied to be free from defects in material or workmanship under normal use and conditions for a period of three years.

SSL: EIA/TIA compliant low profile sliding shelf shall be Middle Atlantic Products model # SSL. SSL shall be constructed of the following materials: shelf shall be made with an attractive black laminate material and rear-mounting brackets shall be steel. Full-extension, nylon roller slides shall extend 10". Shelf area shall be 16" W x 13-3/4" D. Maximum weight capacity shall be 35 lbs. SSL shall be UL Listed in the US and Canada. Low profile sliding shelf shall be RoHS EU Directive 2002/95/EC compliant. Low profile sliding shelf shall be manufactured by an ISO 9001 and ISO 14001 registered company. Low profile sliding shelf shall be warrantied to be free from defects in material or workmanship under normal use and conditions for a period of three years.

Customizable specification clips available at middleatlantic.com

EIA/TIA COMPLIANT



what **great systems** are built on.™

A Group brand |  **legrand**



Middle Atlantic Products

middleatlantic.com | middleatlantic.ca

96-043-1 / rev b / 6-19-15

SS Series

basic dimensions

all dimensions in inches unless otherwise noted [all dimensions in brackets are in millimeters]

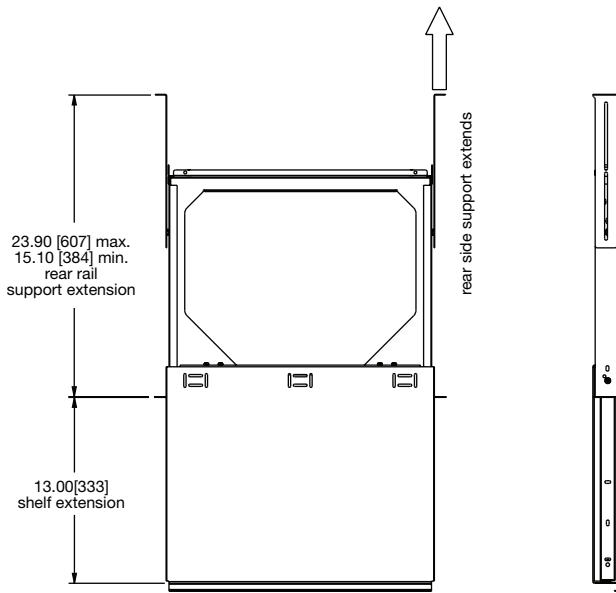

TOP VIEW

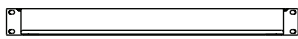

FRONT VIEW

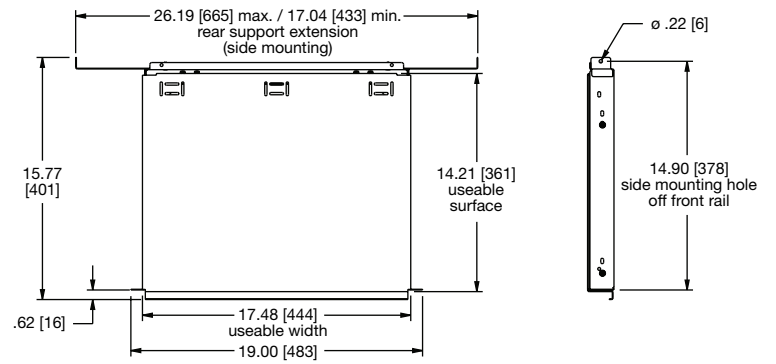

TOP VIEW

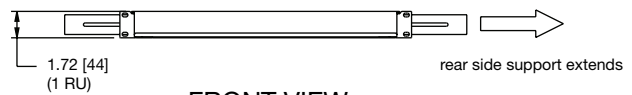

FRONT VIEW

SSL Series

basic dimensions

all dimensions in inches unless otherwise noted [all dimensions in brackets are in millimeters]

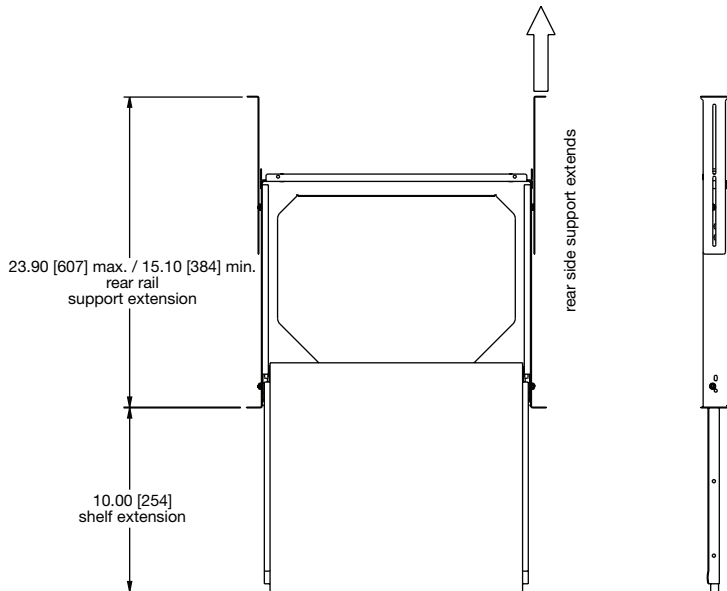

TOP VIEW

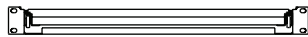

FRONT VIEW

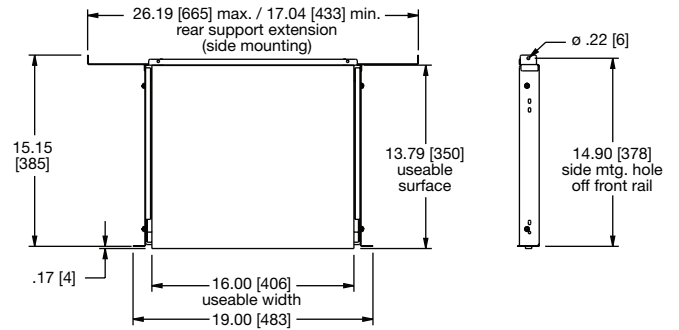

TOP VIEW

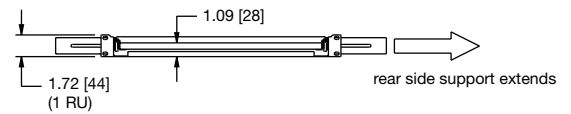

FRONT VIEW