

# Kaleido-X

Unmatched picture quality and layout flexibility

## User's Manual

M770-2800-129

16 December 2014



---

## Copyright & Trademark Notice

Copyright © 2007–2014, Grass Valley USA, LLC. All rights reserved.

Belden, Belden Sending All The Right Signals, and the Belden logo are trademarks or registered trademarks of Belden Inc. or its affiliated companies in the United States and other jurisdictions. Grass Valley, Miranda, Kaleido-X, iControl, NVISION, and Densité are trademarks or registered trademarks of Grass Valley USA, LLC. Belden Inc., Grass Valley USA, LLC, and other parties may also have trademark rights in other terms used herein.

## Terms and Conditions

Please read the following terms and conditions carefully. By using Kaleido multiviewer documentation, you agree to the following terms and conditions.

Grass Valley hereby grants permission and license to owners of Kaleido multiviewers to use their product manuals for their own internal business use. Manuals for Grass Valley products may not be reproduced or transmitted in any form or by any means, electronic or mechanical, including photocopying and recording, for any purpose unless specifically authorized in writing by Grass Valley.

A Grass Valley manual may have been revised to reflect changes made to the product during its manufacturing life. Thus, different versions of a manual may exist for any given product. Care should be taken to ensure that one obtains the proper manual version for a specific product serial number.

Information in this document is subject to change without notice and does not represent a commitment on the part of Grass Valley.

Warranty information is available in the Support section of the Grass Valley Web site ([www.grassvalley.com](http://www.grassvalley.com)).

Title	Kaleido-X User's Manual
Part Number	M770-2800-129
Revision	16 December 2014, 5:00 pm

# toc

## Table of Contents

<b>1</b>	<b>New Features .....</b>	<b>1</b>
<b>2</b>	<b>Getting Started.....</b>	<b>3</b>
	About this Document.....	3
	System Overview .....	4
	Kaleido-X (4RU).....	4
	Kaleido-X (7RU).....	5
	Kaleido-X (14RU) Expansion.....	6
	Kaleido-X16 .....	7
	Kaleido-Modular KMV-3901/3911 .....	9
	Kaleido-XQUAD .....	10
	Kaleido-IP .....	10
	Kaleido-MX.....	11
	Kaleido-Modular-X .....	12
	Cluster .....	12
	Cascade.....	13
	Detailed Directions .....	13
	Verifying your System Configuration .....	13
	Loading a Layout.....	19
	Cabling Diagrams .....	21
	RS-422 Connection Diagram .....	25
	XEdit Application Shortcuts.....	27
<b>3</b>	<b>Operation of the Monitor Wall.....</b>	<b>29</b>
	Key Concepts.....	29
	Detailed Directions .....	33
	Logging on to the Monitor Wall Using a Remote Control Panel.....	33
	Using On-Screen Wall Control.....	36
	Displaying the Dashboard .....	37
	Hiding the Dashboard .....	38
	Loading Layouts.....	39
	Displaying a Source in Full Screen Mode .....	41
	Changing a Source's Aspect Ratio.....	42
	Video Cropping/Zooming .....	43
	Toggling Safe Area Markers.....	44
	Displaying Subtitles and Closed Caption Text.....	45
	Editing UMD Text.....	50
	Selecting an Input Method.....	50
	Assigning Sources to Monitors.....	51
	Changing Crosspoints .....	54
	Using Timers .....	57

Triggering Actions.....	60
Triggering GPI Output Events.....	61
Acknowledging Alarms.....	61
Triggering Audio Monitoring.....	62
Setting a Display Monitor’s Output Resolution.....	64
Changing the IP Address of a Multiviewer from the Monitor Wall.....	66
<b>4 Managing Kaleido-X Systems.....</b>	<b>69</b>
Key Concepts.....	69
Detailed Directions.....	72
Opening the XEdit Software.....	73
Using XEdit Online.....	75
Importing a Database.....	79
Exporting a Database.....	80
Creating a Backup.....	83
Restoring a Backup.....	84
Creating a Single Multiviewer System.....	84
Creating a Cluster.....	88
Configuring the System Representation.....	94
Restoring Factory Defaults.....	111
Managing Multiple Databases Efficiently.....	116
<b>5 Calibrating the Kaleido-X.....</b>	<b>119</b>
Key Concepts.....	119
Detailed Directions.....	123
Managing Calibration Profiles.....	123
Multiviewer Output Calibrations.....	125
Multiviewer Input Calibrations.....	132
Router Output Calibrations.....	148
GPI/Genlock Calibrations.....	150
<b>6 Configuring Alarms.....</b>	<b>151</b>
Key Concepts.....	151
Alarm.....	151
General Status Manager (GSM).....	151
Alarm Browser.....	152
Alarm Status.....	152
External Alarm Provider.....	153
Lookup Service.....	153
Alarm Debouncing.....	154
Alarm Suppression.....	154
Global Alarms.....	155
Virtual Alarm.....	155
Sub-Alarm.....	156
Alarm Monitor.....	156
Teletext, Subtitles, and Closed Captions.....	156



Dolby E/AC-3 Metadata .....	157
Microphone Loudness Measurement .....	159
Detailed Directions .....	159
Configuring Alarm Thresholds .....	159
Configuring Alarm Debouncing .....	162
Managing Alarm Providers .....	163
Managing Virtual Alarms .....	164
Managing Alarm Logging .....	171
Publishing Alarms to SNMP Devices .....	173
<b>7 Logical Sources .....</b>	<b>177</b>
Key Concepts .....	177
Detailed Directions .....	178
Creating and Configuring Logical Sources .....	178
Monitoring Internal-Router Outputs on the Monitor Wall (Sample Scenario) ..	192
<b>8 Setting Up Rooms .....</b>	<b>195</b>
Key Concepts .....	195
Detailed Directions .....	195
Managing Rooms .....	195
Configuring Displays .....	202
Managing Display Libraries .....	214
<b>9 Creating Layouts .....</b>	<b>217</b>
Key Concepts .....	217
Layouts and Layout Elements .....	217
Aspect Ratio .....	219
Cropping Mode .....	220
Spanning .....	221
Detailed Directions .....	223
Managing Layouts .....	223
Configuring Video Monitors .....	236
Configuring Audio Monitors .....	252
Configuring Loudness Monitors .....	254
Configuring Audio Scales .....	256
Configuring Time Code Monitors .....	259
Configuring Timers .....	261
Configuring UMDs .....	267
Configuring Alarm Monitors .....	274
Configuring Subtitling Monitors .....	277
Configuring Metadata Monitors .....	282
Configuring V-Chip Monitors .....	283
Configuring Clocks .....	285
Working with Composite Monitors .....	289
Using the Region Editor .....	295
Format Painting .....	297

Managing Widget Libraries .....	298
<b>10 Creating Actions.....</b>	<b>301</b>
Overview.....	301
Key Concepts.....	301
Detailed Directions .....	303
Creating Monitor Wall Actions .....	303
Creating Background Actions.....	304
<b>11 Managing RCP Users.....</b>	<b>311</b>
XEdit Quick Start Task List.....	311
Key Concepts.....	311
Kaleido-RCP2.....	311
RCP-200.....	311
Detailed Directions .....	312
Managing RCP Users .....	312
Managing Room Access .....	313
Setting Room Preferences .....	313
Setting RCP User Preferences .....	316
<b>12 Routers &amp; Kaleido-X .....</b>	<b>325</b>
Overview.....	325
Key Concepts.....	326
Router Control Configurations .....	327
Router Configuration Scenarios.....	329
Router Protocols .....	332
Serial Connections .....	334
Q & A .....	336
Detailed Directions .....	338
Importing Router Configurations from an NV9000 System Controller.....	338
Configuring an External Router .....	345
Configuring a Router Controller.....	358
Configuring a Multiviewer’s Internal Router .....	364
Router Connections .....	371
<b>13 Tally Interface Devices &amp; Timer Systems .....</b>	<b>375</b>
Overview.....	375
Key Concepts.....	375
Detailed Directions .....	376
Alpermann+Velte Timer System .....	376
GPI-1501 General Purpose Interface I/O Module .....	381
Configuring Serial Tally Systems .....	387
Ross Video Production Switcher .....	389
Sony Production Switcher .....	394
Kahuna Production Switcher.....	398

---

Kayak Production Switcher .....	404
Kayenne Production Switcher.....	411
K-Frame Switchers.....	419
Zodiak Production Switcher .....	427
Serial Port Test Agent.....	434
<b>14 Kaleido Remote Control Protocol .....</b>	<b>437</b>
Overview.....	437
<b>15 Using the Serial to TCP/IP Dispatcher .....</b>	<b>439</b>
Overview.....	439
<b>16 Administration and Servicing .....</b>	<b>441</b>
Key Concepts.....	441
Default IP Settings.....	442
Hardware and Software Options .....	443
Dashboard Messages.....	447
Network Considerations & Port Usage.....	451
Detailed Directions .....	456
Assigning an IP Address to Each Device in your System .....	456
Enabling Options.....	471
Installing Kaleido-X Client Applications.....	473
Opening XAdmin.....	487
XAdmin Access Control.....	499
Restarting and Shutting Down a Kaleido-IP Multiviewer .....	503
Configuring Head Streaming on a Kaleido-IP .....	506
Configuring Virtual Network Adapters on a Kaleido-IP .....	508
Adding Fonts to a Kaleido-IP.....	509
Configuring Power Supply Redundancy on a Kaleido-X16.....	511
Obtaining EDID Data from Displays when Using the DXF-100 Interface .....	513
Servicing .....	514
Upgrading your Multiviewer System .....	518
<b>Index.....</b>	<b>519</b>
<b>Contact Us .....</b>	<b>529</b>



# 1 New Features

The following is a list of features and enhancements introduced in Kaleido-X version 7.60. Refer to the Release Notes for more information.

## New Features and Enhancements in Kaleido-X Version 7.60

- **Kaleido-IP:** Support for DVB teletext compliant with ETSI EN 300 472 V1.3.1 (2003-05). See [Teletext, Subtitles, and Closed Captions](#) on page 156, [Managing Calibration Profiles](#), on page 123, [Setting a Video Monitor's Text Mode](#), on page 248, and [Displaying Subtitles and Closed Caption Text](#), on page 45.
- **Timers, time code data:** Support for Alpermann+Velte timer systems. See [Alpermann+Velte Timer System](#) on page 376.
- **Windows 8 support:** All Kaleido client applications are compatible with the Windows 8, and Windows 8.1 operating systems.
- **Router Control installation:** To circumvent problems resulting from the increased security requirements imposed with recent Java updates, the Router Control Matrix and Single Bus applications are not deployed as Java Web Start applications anymore. A native installer is available for Router Control, instead. The applications, along with the appropriate JRE, are installed in a private directory, under your user profile. See [Installing Router Control](#) on page 481, and [Uninstalling Router Control](#), on page 484.
- **Signal Path Viewer installation:** To circumvent problems resulting from the increased security requirements imposed with recent Java updates, the Signal Path Viewer application is not deployed as a Java Web Start application anymore. A native installer is available instead. The application, along with the appropriate JRE, is installed in a private directory, under your user profile. Refer to *Installing Signal Path Viewer*, and *Uninstalling Signal Path Viewer*, in the Kaleido-X User's Manual, for details. See [Installing Signal Path Viewer](#) on page 485, and [Uninstalling Signal Path Viewer](#), on page 486.
- **XAdmin:** Dynamic proxy configuration via proxy auto-config (PAC) files, for Kaleido-IP multiviewers. See [Adding HLS transport streams](#) on page 105.
- **Kaleido-MX, Kaleido-Modular-X:** Enhanced graphical quality in small video windows.
- **Kaleido-X, Kaleido-X16 with Audio Bridge Terminal (ABT):** *Microphone loudness* values are available as text, for ABT channels. Playout is assumed to be mono. The values (in dBFS) are updated every second, and have a precision of 0.5 dB. See [Microphone Loudness Measurement](#) on page 159.



# Getting Started

# 2

This chapter provides an overview of the different Kaleido multiviewer models and their initial configuration process.

## Summary

<i>System Overview</i> .....	4
<i>Detailed Directions</i> .....	13
<i>Cabling Diagrams</i> .....	21
<i>RS-422 Connection Diagram</i> .....	25
<i>XEdit Application Shortcuts</i> .....	27

## About this Document

The *Kaleido-X User's Manual* is intended to help you leverage the full working potential of the Kaleido-X software and XEdit application for controlling and monitoring audio, and video broadcast signal paths for interfacing, routing distribution and other peripheral devices.

The Kaleido-X series hardware—including the Kaleido-IP, Kaleido-MX, Kaleido-Modular-X, Kaleido-Modular KMV-3901/3911, Kaleido-XQUAD, Kaleido-X16, and Kaleido-X multiviewer models—and the associated software products are designed and produced by Grass Valley.

For installation instructions, refer to the *Quick Start Guide* that shipped with your multiviewer. Once you have completed your multiviewer's initial installation, perform a system verification (see [Verifying your System Configuration](#), on page 13), load a layout on the monitor wall if you haven't done so already (see [Loading a Layout](#), on page 19), and then review the more advanced topics in [Administration and Servicing](#), on page 441, to fine-tune your initial system configuration.

After you have established that your basic configuration works as expected, move on to the other chapters in this manual, to complete your system configuration until it meets your actual monitoring requirements.

---

**Note:** In line with our commitment to environmental preservation, only the Quick Start Guide for your multiviewer model, and some ancillary documents (e.g. welcome letters, warranty cards) are distributed in printed form. All manuals and the Release Notes are available on the Kaleido-X DVD. You can obtain the latest version of the manuals, the Release Notes, as well as software and useful data, from the *Software and documentation* section of Grass Valley's support portal.

---

## System Overview

This section reviews the different multiviewer models that support the Kaleido-X software:

- For the Kaleido-X, see
  - [Kaleido-X \(4RU\)](#), on page 4,
  - [Kaleido-X \(7RU\)](#), on page 5, and
  - [Kaleido-X \(14RU\) Expansion](#), on page 6.
- For the Kaleido-X16-S (single head) and Kaleido-X16-D (dual head), see [Kaleido-X16](#), on page 7.
- For the KMV-3901, and KMV-3911, see [Kaleido-Modular KMV-3901/3911](#), on page 9.
- For the Kaleido-XQUAD and Kaleido-XQUAD-DUAL, see [Kaleido-XQUAD](#), on page 10.
- For the Kaleido-IP X310, X110, X300, and X100, see [Kaleido-IP](#), on page 10.
- For the Kaleido-MX, see [Kaleido-MX](#), on page 11.
- For the Kaleido-Modular-X, see [Kaleido-Modular-X](#), on page 12.
- For a configuration combining several multiviewers operated as a single system, see [Cluster](#), on page 12.
- For a system combining inputs from two or three multiviewers on a single monitor wall display, see [Cascade](#), on page 13.

### Kaleido-X (4RU)

The Kaleido-X (4RU) is a multi-room, multi-image display processor and router in a single, expandable chassis. Its unique mix of capabilities represents the most integrated monitoring and routing solution. As a multi-image processor, it offers the highest level of signal flexibility. Each chassis can display 32 HD, SD or Analog inputs any number of times, across 4 displays of any resolution and orientation.



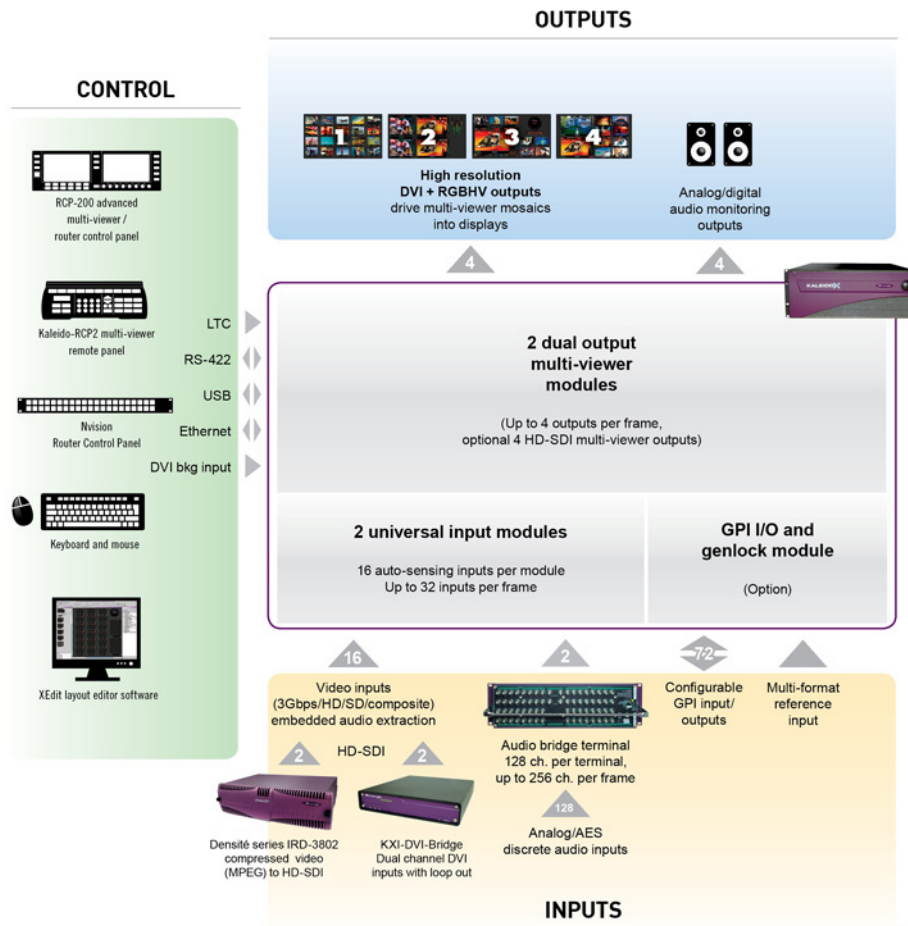

*Kaleido-X (4RU) system overview*

## Kaleido-X (7RU)

The Kaleido-X (7RU) is a multi-room, multi-image display processor and router in a single, expandable chassis. Its unique mix of capabilities represents the most integrated monitoring and routing solution. As a multi-image processor, it offers the highest level of signal flexibility. Each chassis can display 96 HD, SD or Analog inputs any number of times, across 8 displays of any resolution and orientation. As a router, it offers switching of 96 unprocessed inputs to 48 HD/SD outputs for feeding monitors, test equipment and master control or production switchers.

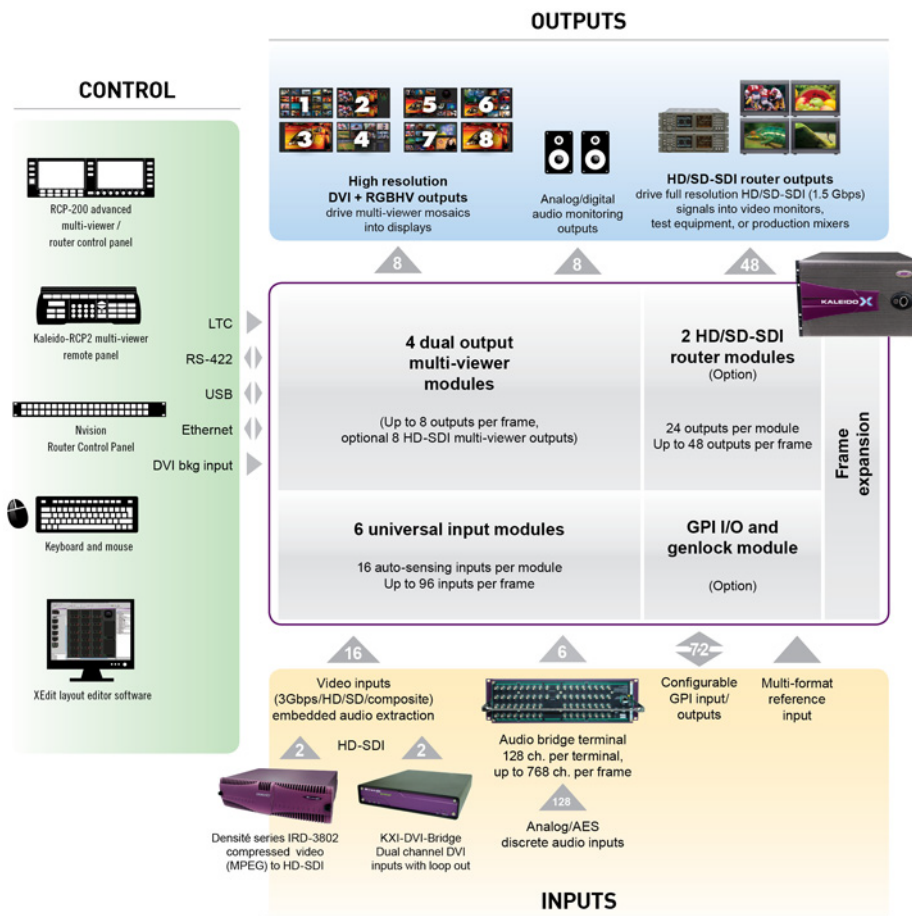

*Kaleido-X (7RU) system overview*

## Kaleido-X (14RU) Expansion

Since version 3.00 of the Kaleido-X software, it is possible to expand the input connectivity of one Kaleido-X (7RU) frame to include that of a second. The two frames, each with its own expansion (KXO-EXP) card, are connected by a high bandwidth cable, such that all the output (KXO) modules on each frame (up to 6 in total) have access to all inputs (KXI) on each frame (up to 192 in total) without any blocking or bandwidth limitations.

Using XEdit, the two frames can be configured as a single system, allowing *rooms* to share input modules from either frame. The expansion card allows seamless sharing of video, audio monitoring output, time code inputs, reference input, metadata information (CC, XDS, alarms, etc.), and audio level meter data. Refer to the "Kaleido-X (7RU) Expansion" chapter in the *Kaleido-X (7RU) Hardware Description & Installation Manual* for more information.

### 12 independent multi-viewer displays



*Kaleido-X (14RU) expansion system overview*

## Kaleido-X16

The Kaleido-X16 is a compact, ultra-quiet multiviewer with 16 inputs, and one or two HDMI outputs. It offers the highest level of image quality, and can be used with 3Gbps/HD/SD and Analog video. It is ideal for small control rooms, although it can also be paired with routers to create the very largest combined multiviewer and routing systems.



There are two models: Kaleido-X16-S (single head) and Kaleido-X16-D (dual head).

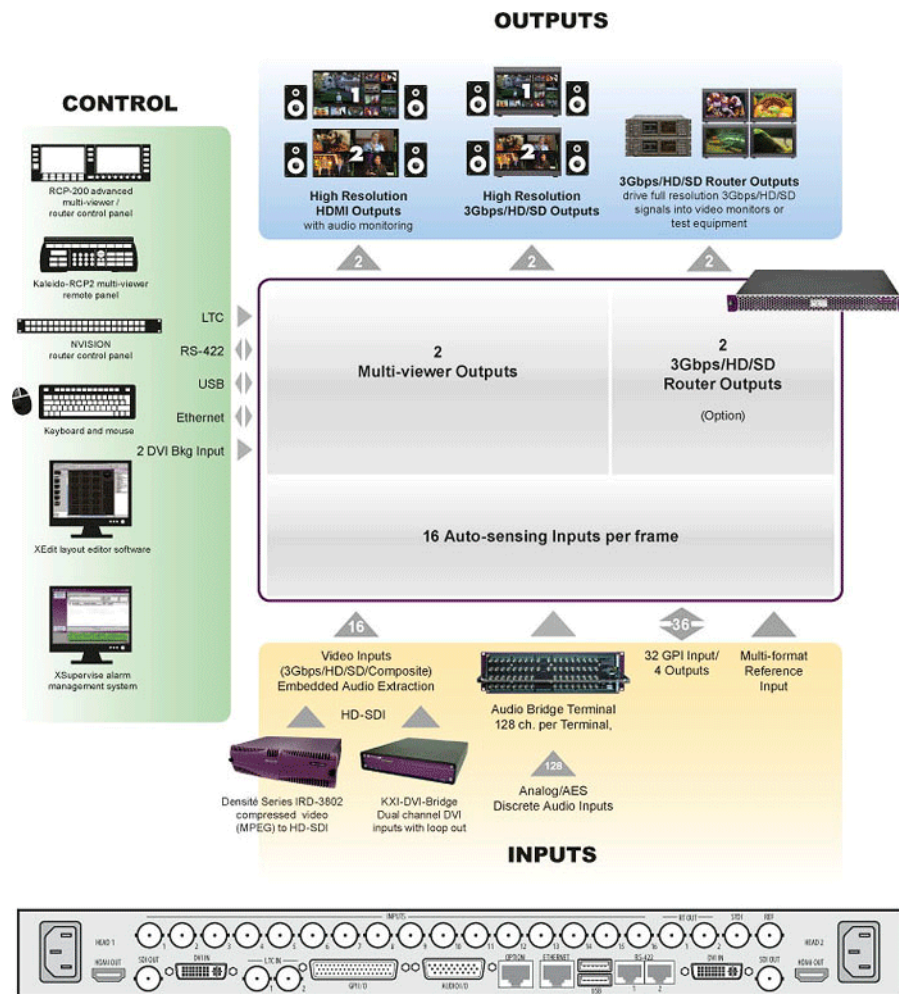

*Kaleido-X16-D system overview*

The 1RU Kaleido-X16 is ideal for smaller monitoring facilities, such as call letter television station master control rooms, mobile trucks and production fly cases, as well as community television. The Kaleido-X16's super silent design is highly appreciated for use within studios and control rooms.

Kaleido-X16 provides a subset of the features of the Kaleido-X (4RU) and (7RU) models:

- 1RU non-modular frame
- 16 auto-sensing 3Gbps/HDMI/SD/Analog video inputs, one or two independent HDMI outputs
- Two 3Gbps/HDMI/SD router outputs
- 3Gbps with 3D support (SMPTE ST 425-1 Level A & B)
- Expansion through combination with upstream router
- 4 analog channel, 2 digital channel audio monitoring
- One or two HD-SDI monitoring outputs with support of 3Gbps signals
- DVI and compressed (MPEG) video accepted with optional interfaces

- DXF-100 optical DVI extension module simplifies long runs to monitors from frame, and is a single fiber solution for supporting high-resolution (1920 × 1200) displays over distances of up to 1000 m (3280 ft)
- Choice of multiviewer remote control panels: simple Kaleido-RCP2 and advanced RCP-200 with router control
- Internal router control by NVISION control panel and NV9000 system controller
- Super silent for installation within studios and control rooms

## Kaleido-Modular KMV-3901/3911

The **Kaleido-Modular KMV-3901/3911** is an expandable, 8-input, dual-output multiviewer (3Gbps/HD/SD) on one Densité Series card. Hosted in a Densité 3 frame, the KMV-3901/3911 is the most space- and energy-efficient multiviewer system, with up to 20 multiviewer outputs per 3 RU frame, or up to 288 multiviewer outputs when connected to an upstream router.

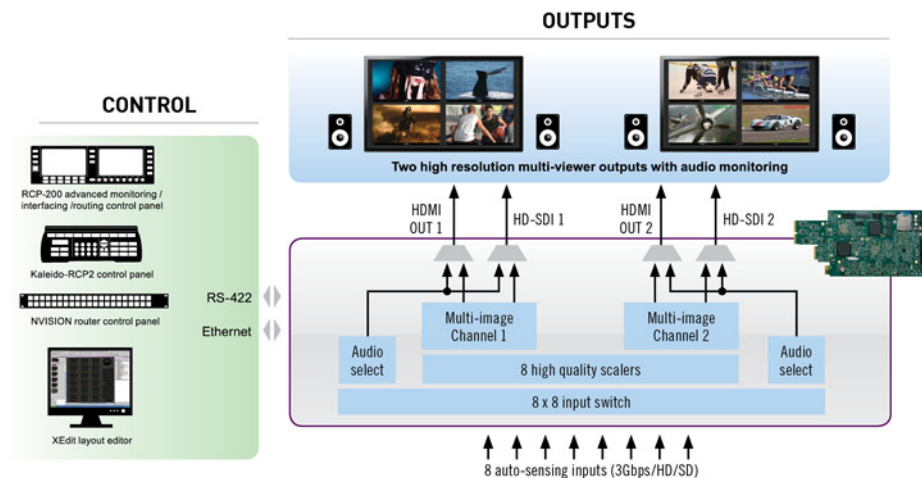

*Overview of single card functionality*

### Kaleido-Modular KMV-3901/3911 features

With its unmatched space and energy efficiency, Kaleido-Modular is ideal for production monitoring in trucks. The multiviewer system integrates tightly with the highly space-efficient NVISION 8288 Truck router (288 × 576 in 10 RU), as well as Densité signal processing cards, and third-party production switchers. Control of a highly integrated system is simplified with the RCP-200 panel, which can operate the router and multiviewer, as well as signal processing and distribution cards.

The KMV-3901/3911 provides a subset of the features of the Kaleido-X (4RU) and (7RU) models:

- Four or eight auto-sensing 3Gbps/HD/SD video inputs, one or two independent HDMI outputs
- Video signals can be repeated in up to eight windows, and scaled up to 1920 × 1200 pixels
- Audio signal, and video time code and AFD/WSS data can be extracted for on-screen display

- A reference signal from a REF-1801 Densité card can be used to minimize processing delay, and reference clocks on the monitor wall
- Expansion through combination with upstream router
- DXF-200 extension module simplifies long runs to monitors from Densité frame, and is a single fiber solution for supporting high-resolution (1920 × 1200) displays over distances of up to 1000 m (3280 ft)
- Choice of multiviewer remote control panels: simple Kaleido-RCP2 and advanced RCP-200 with router control
- Control by NVISION control panel and NV9000 system controller
- Super silent for installation within studios and control rooms

## Kaleido-XQUAD

The Kaleido-XQUAD is a standalone quad-split multiviewer that is ideal for truck and studio monitoring. It is available in two versions: the **Kaleido-XQUAD** features four 3Gbps/HD inputs and a single multiviewer output (HDMI/HD-SDI), and the **Kaleido-XQUAD-DUAL** offers eight 3Gbps/HD inputs and two multiviewer outputs. Both versions offer exceptional display flexibility and outstanding space and energy efficiency, using a 1RU half width frame with silent ventilation for installation within studios. The multiviewer can be used for small installations with one or two displays, and in much larger configurations using multiple Kaleido-XQUADs.

## Kaleido-IP

The Kaleido-IP can monitor and display HD and SD television programs distributed over IP, across two HDTV displays. It supports MPEG-2 and H.264/AVC compressed video, and the AAC, AC-3, DD+, MPEG-1, MPEG-2, MPEG-4 AAC LC, and MPEG-4 HE-AAC compressed audio formats, within unencrypted DCII, DVB, or ATSC streams. The **Kaleido-IP X310** supports concurrent decoding of up to 64 MPEG-2 or up to 32 H.264 HD video programs. In the case of SD signals, they support concurrent decoding of up to 128 MPEG-2 or up to 64 H.264 programs. The **Kaleido-IP X110** supports concurrent decoding of up to 16 MPEG-2 or up to 12 H.264 HD programs, and up to 48 MPEG-2 or up to 24 H.264 SD programs. The **Kaleido-IP X300** supports concurrent decoding of up to 24 MPEG-2 or up to 16 H.264 HD programs, and up to 64 MPEG-2 or up to 32 H.264 SD programs. The **Kaleido-IP X100** supports concurrent decoding of up to 8 MPEG-2 or up to 6 H.264 HD programs, and up to 24 MPEG-2 or up to 12 H.264 SD programs.



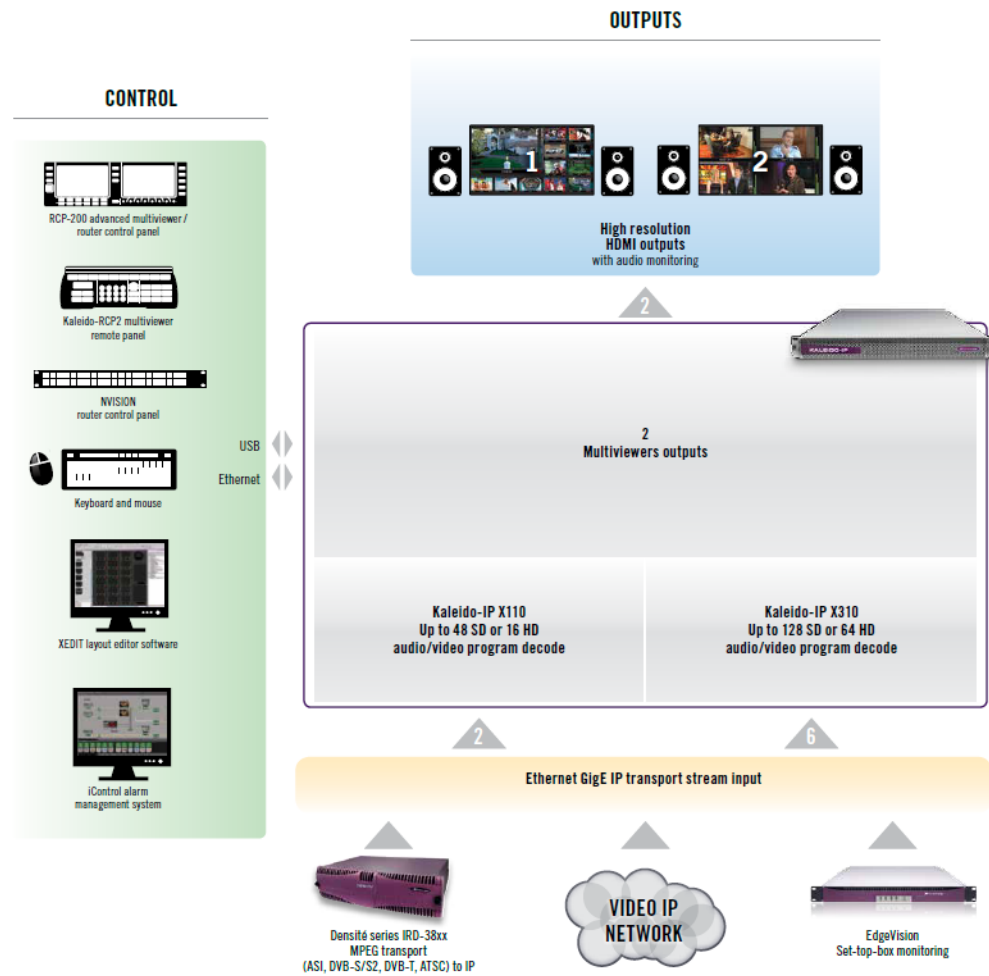

*Kaleido-IP system overview*

## Kaleido-MX

The **Kaleido-MX** standalone multiviewer system is ideal for production control rooms, trucks and outside broadcast operations. Available in two form factors (1 RU, and 3 RU), the Kaleido-MX supports up to 64 video inputs, and up to four multiviewer outputs.

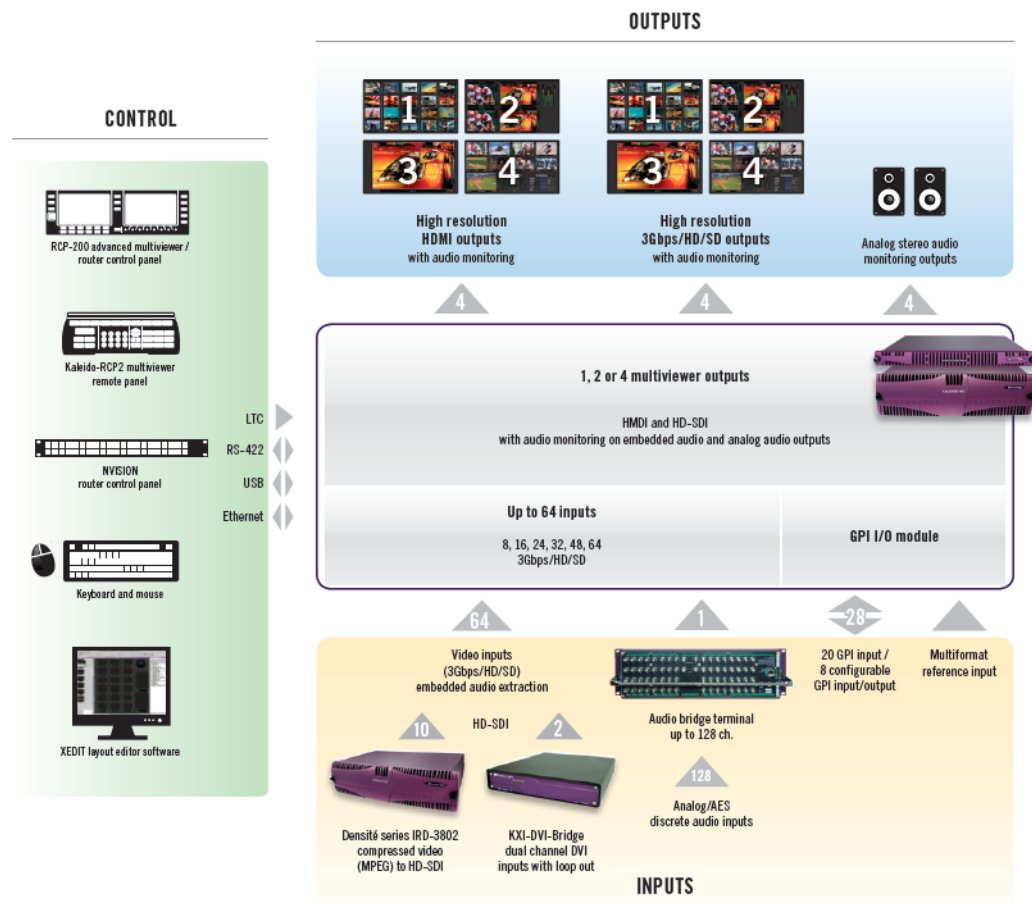

Kaleido-MX system overview

## Kaleido-Modular-X

The **Kaleido-Modular-X** offers a flexible and scalable multiviewer solution for TV production optimized for the space, power and weight considerations found in studios and outside broadcast trucks. FlexBridge coax cable bridging between the input and output modules allows for the installation of the input stage next to the router or sources, and the output stage next to displays, for simpler, cost-effective cabling with none of the risk associated with HDMI extenders. The Kaleido-Modular-X supports up to 64 video inputs, and up to four multiviewer outputs.

## Cluster

As of version 4.00 of the Kaleido-X software, it is possible to configure a *cluster system*, allowing operation of layouts sharing output signals from multiple multiviewers fed by a router, while using only one mouse, and one Kaleido-RCP2 or RCP-200. Refer to [Creating a Cluster](#), on page 88, for more information.



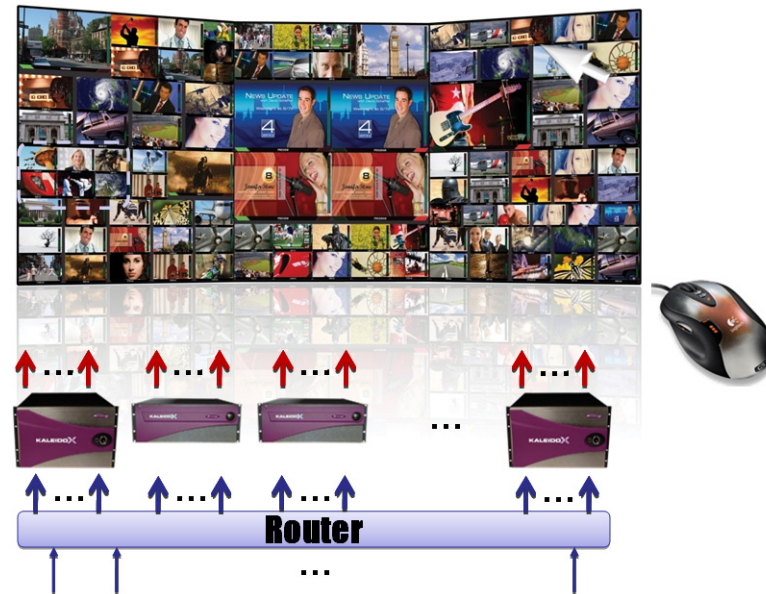

Cluster system overview

## Cascade

It is possible to configure up to three Kaleido-X16 or KMV-3901/3911 multiviewers as a cascade system. Unlike the cluster, whose purpose is to increase the number of output heads in a room, the cascade increases the maximum number of inputs that can be displayed to a single monitor wall display. It is also possible to configure a hybrid cascade system, involving one Kaleido-IP and one Kaleido-X, or one Kaleido-IP and one Kaleido-X16, to monitor both baseband and IP sources at once, on the same monitor wall display. For more information, refer to the appropriate *Cascade Step-by-Step Configuration* guide, available on the Kaleido-X DVD, and from Grass Valley's support portal.

## Detailed Directions

### Verifying your System Configuration

You can check internal system statuses via the Web-based XAdmin application.

#### Verifying a Multiviewer's Internal Statuses and Options

##### To perform a system verification

- 1 Open XAdmin. See [Opening XAdmin](#) on page 487.  
XAdmin's Status and Options page appears, displaying a list of all modules and their statuses.

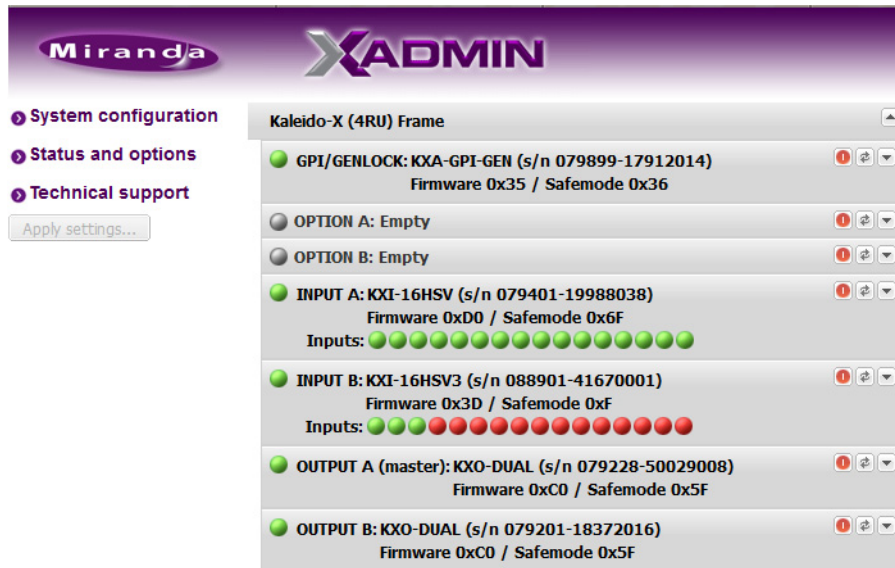

For example, in the case of a Kaleido-X multiviewer, the heading rows show the card type, serial number, firmware and safemode versions, a card status indicator, and input signal status indicators. The card status indicator shows whether the card is running normally (green) or in safe mode (red). The signal status indicators reveals the presence of a valid input signal at the corresponding connector.

Note: In the case of a Kaleido-IP multiviewer, heading rows do not provide status information.

- 2 Move the pointer to an input signal status indicator to view the associated signal format.

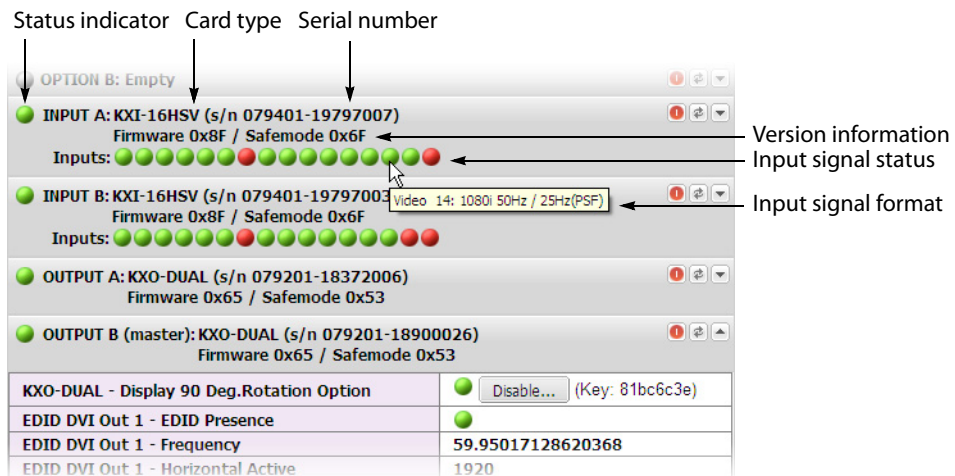

- 3 Click the arrow button at the end of a module's heading row to view more detailed information about this module.

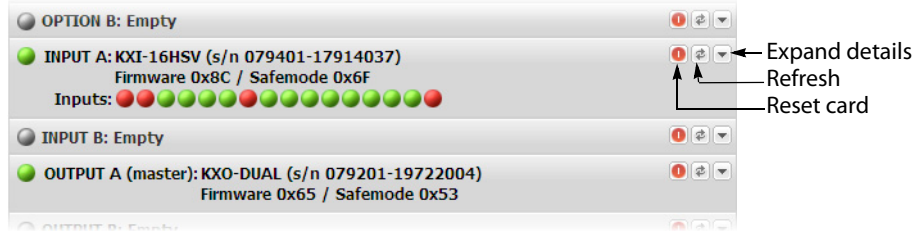

- At any time you can click the Refresh button to make sure the data displayed for the selected module is up to date.
  - In the case of a **Kaleido-X** multiviewer, click the “Reset card” button at the end of a card’s heading row to reset the card remotely, directly from your Web browser.
  - In the case of a **Kaleido-X16** or **Kaleido-Modular KMV-3901/3911** multiviewer model, click the “Reset multiviewer” button at the end of the multiviewer’s heading row to reset the multiviewer remotely, directly from your Web browser.
  - In the case of a **Kaleido-IP** multiviewer, clicking the arrow buttons reveals information on bandwidth usage, network status, CPU/GPU usage and temperature, memory usage and PSU status. Clicking the “Reset multiviewer” button is equivalent to the procedure described under [Restarting a Kaleido-IP Multiviewer](#), on page 504, except that, in the first case, you get no feedback from XAdmin.
- 4 Review the enabled options for each module, and make sure that no error is reported.

## Getting Started

### Verifying your System Configuration

Option	Status	Action	Key
KXI-16 - CC/XDS Option	Green	Disable...	(Key: c88820a6)
KXI-16 - Dolby E Option	Red	Enable...	
KXI-16 - Embedded Audio Option	Green	Disable...	(Key: a8459e2f)
KXI-16 - Loudness Option	Red	Enable...	
ABT IP address			10.6.5.251
KXI-16 - 48va Status	Green		
KXI-16 - 48vb Status	Green		
KXI-16 - Audio Box Data Error	Green		
KXI-16 - Audio Box Detected	Green		
KXI-16 - CPLD Version			0x2
KXI-16 - Card Model			16.0
KXI-16 - Card Patch Number			0x8
KXI-16 - Strap value			8.0
KXI-16 - Temperature Control (°C)			33.0
KXI-16 - Temperature DC/DC converter (°C)			49.0
KXI-16 - Temperature FX/SX 1 (°C)			48.0
KXI-16 - Temperature FX/SX 2 (°C)			48.0
KXI-16 - Temperature Sensor 1 (°C)			29.0
KXI-16 - Temperature Sensor 2 (°C)			48.0
KXI-16 - Temperature Serdes 1 (°C)			34.0
KXI-16 - Temperature Serdes 2 (°C)			45.0
KXI-16 - Voltage Supply 1.2	Green		
KXI-16 - Voltage Supply 1.8	Green		
KXI-16 - Voltage Supply 2.5	Green		
KXI-16 - Voltage Supply 3.3	Green		
Video 01	Green		720p 59.94Hz (EAV/SAV OK)
Video 02	Green		720p 59.94Hz (EAV/SAV OK)
Video 12	Green		NTSC M (EAV/SAV OK)
Video 13	Green		PAL M (EAV/SAV OK)
Video 14	Green		1080i 50Hz / 25Hz(PSF) (EAV/SAV OK)
Video 15	Green		NTSC M (EAV/SAV OK)
Video 16	Red		

Note: In the case of a Kaleido-IP multiviewer, there are currently no options that can be enabled via XAdmin. See [Hardware and Software Options](#) on page 443 for more information on the options available for the different multiviewer models.

- 5 If your system supports a GPI interface, you can check the main system statuses of the multiviewer, to make sure that there are no errors or alerts related to system temperature, power supply status, fan operation, or other card fault conditions.

Kaleido-X (7RU) Frame	
● GPI/GENLOCK: KXA-GPI-GEN (s/n 079899-17912001) Firmware 0x35 / Safemode 0x36	
KXA-GPI-GEN - 1.2V status	●
KXA-GPI-GEN - 48V power supply A fuse status	●
KXA-GPI-GEN - 48V power supply B fuse status	●
KXA-GPI-GEN - Board high temperature	●
KXA-GPI-GEN - Board temperature (°C)	50.0
KXA-GPI-GEN - Card invalid	●
KXA-GPI-GEN - Normal mode	
KXA-GPI-GEN - Power supply A status	●
KXA-GPI-GEN - Power supply B status	●
KXA-GPI-GEN - Rear Fan 1 status	●
KXA-GPI-GEN - Rear Fan 2 status	●
KXA-GPI-GEN - Rear Fan 3 status	●
KXA-GPI-GEN - Rear Fan 4 status	●
KXA-GPI-GEN - Rear Fan 5 status	●
KXA-GPI-GEN - Rear Fan 6 status	●
KXA-GPI-GEN - Rear present	●

Temperatures  
PSU statuses  
Fan statuses

The other system-related statuses should all be normal, although if you left the door open when checking a GPI/Genlock card's LEDs, you may see a warning under **Chassis Door Open Status**.

Note: The KXA-GPI-GEN card, with support for GPI, is standard on the Kaleido-X (7RU), and optional for the Kaleido-X (4RU). GPI support is built-in on the Kaleido-X16, and Kaleido-Modular KVM-3901/3911 multiviewers. Not available on the Kaleido-IP.

If you have a Kaleido-X (4RU) without a KXA-GPI-GEN card, then you will find the fan and power supply statuses listed with the master output card's information.

OUTPUT A (master): KXO-DUAL (s/n 079201-36048080) Firmware 0x65 / Safemode 0x19	
KXO-DUAL - Display 90 Deg.Rotation Option	● Enable...
EDID DVI Out 1 - EDID Presence	●
EDID DVI Out 1 - Frequency	59.649155214028866
EDID DVI Out 1 - Horizontal Active	1920
KXO-DUAL - FPGA3 Version	0x909
KXO-DUAL - Fan 1 Status	●
KXO-DUAL - Fan 2 Status	●
KXO-DUAL - Fan 3 Status	●
KXO-DUAL - Fan 8 Status	●
KXO-DUAL - Fan 9 Status	●
KXO-DUAL - Firmware Package Number	0x65
KXO-DUAL - PSU B absent	●
KXO-DUAL - PSU B vendor id unknown	●
KXO-DUAL - Power Supply A AC Status	●
KXO-DUAL - Power Supply A DC Status	●
KXO-DUAL - Power Supply A Temperature Status	●
KXO-DUAL - Power Supply B AC Status	●
KXO-DUAL - Temperature Control (°C)	35.0
KXO-DUAL - Temperature DC/DC converter (°C)	37.0
KXO-DUAL - Temperature DDR (°C)	41.0
KXO-DUAL - Temperature FX (°C)	40.0
KXO-DUAL - Temperature Mezzanine (°C)	27.0
KXO-DUAL - Temperature Power circuit (°C)	37.0
KXO-DUAL - Temperature SX (°C)	0.0

Fan statuses  
PSU statuses  
Temperatures

In the case of a Kaleido-X16 or Kaleido-Modular KMV-3901/3911 multiviewer, the relevant indicators are found under the SYSTEM module.

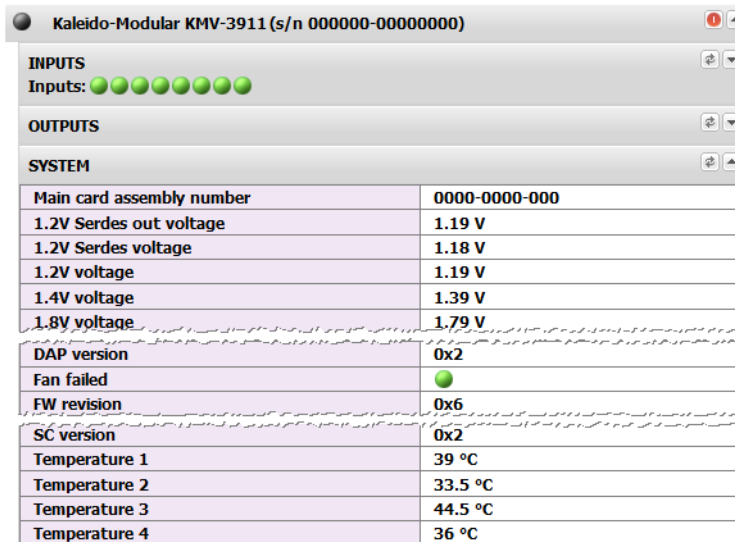

Kaleido-Modular KMV-3911 (s/n 000000-00000000)	
<b>INPUTS</b>	
Inputs:	●●●●●●●●
<b>OUTPUTS</b>	
<b>SYSTEM</b>	
Main card assembly number	0000-0000-000
1.2V Serdes out voltage	1.19 V
1.2V Serdes voltage	1.18 V
1.2V voltage	1.19 V
1.4V voltage	1.39 V
1.8V voltage	1.79 V
DAP version	0x2
Fan failed	●
FW revision	0x6
SC version	0x2
Temperature 1	39 °C
Temperature 2	33.5 °C
Temperature 3	44.5 °C
Temperature 4	36 °C

## Verifying a Kaleido-RCP2

To verify that the Kaleido-RCP2 is functioning normally

- 1 Log on to the appropriate room the Kaleido-RCP2 (see [Logging on to the Kaleido-RCP2](#), on page 469).
- 2 Test various operations using the Kaleido-RCP2 keyboard and the mouse (e.g. load layout presets).

## Verifying an RCP-200

To verify that the RCP-200 is functioning normally

- Log on to the appropriate room from the RCP-200 (see [Logging on to the RCP-200](#), on page 464).

On the RCP-200's right-hand screen, you should see a thumbnail view of the room displays in the **Room View** navigation pane, with one of the displays selected, and a view of the monitor wall layout as it appears on the selected display.

## Verifying an Audio Bridge Terminal

To verify that the ABT is functioning normally

- Inspect the ACTIVITY and front panel LEDs on the unit to make sure there are no error conditions.

The ACTIVITY indicator is located on the right-hand side of the rear panel. This LED reports the status of the Ethernet connection as follows:

Color	Board Status
Off	No link detected
Green	Normal (good link)

Color	Board Status
Orange	Activity
Red	Hardware fault
Flashing red	Upgrading firmware

Two LEDs are visible on the front panel, one for each power supply. When lit, they both indicate the same status:

Color	Board Status
Green	Normal
Flashing green	Normal, rebooting
Orange	Warning
Flashing Orange	Warning, rebooting
Red	Hardware fault
Flashing red	Upgrading firmware

When the ABT is powered up, all three LEDs will be orange until the boot sequence is terminated. This is a visual indicator that the LEDs are functioning properly.

## Loading a Layout

If your system was configured prior to shipment, then the designated layout will show up on all displays. Otherwise, a gray screen will appear with the following message in the middle:

"No layout has been assigned to this room. Please load a layout."

No layout has been assigned to this room. Please load a layout.

### To load a layout on the monitor wall

- 1 Connect a mouse to the Kaleido-RCP2 or RCP-200 (if available) and log on to the multiviewer from the control panel, if you have not already done so (see [Logging on to the Monitor Wall Using a Remote Control Panel](#), on page 33).

Alternatively, connect the mouse directly to one of the USB ports on the multiviewer.

- 2 Right-click anywhere on the monitor wall, point to **Monitor wall** (if you clicked a layout element), and then click **Load layout** on the menu.

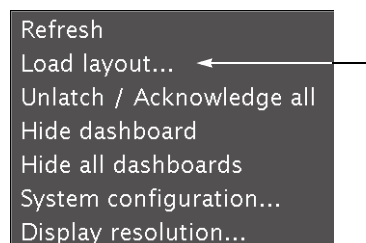

*Monitor wall menu*



A layout browser appears on the displays associated with the current room.

---

Note: By default, each room is associated with one multiviewer output or output card. Most predefined layouts are configured to show all video streams for a given input card (in the case of the Kaleido-X, and Kaleido-MX systems) or all video streams connected to the multiviewer's inputs (in the case of a Kaleido-X16 or Kaleido-Modular KMV-3901/3911 multiviewer model).

---

3 Choose a default layout from the layout browser.

The video sources should appear on the room displays.

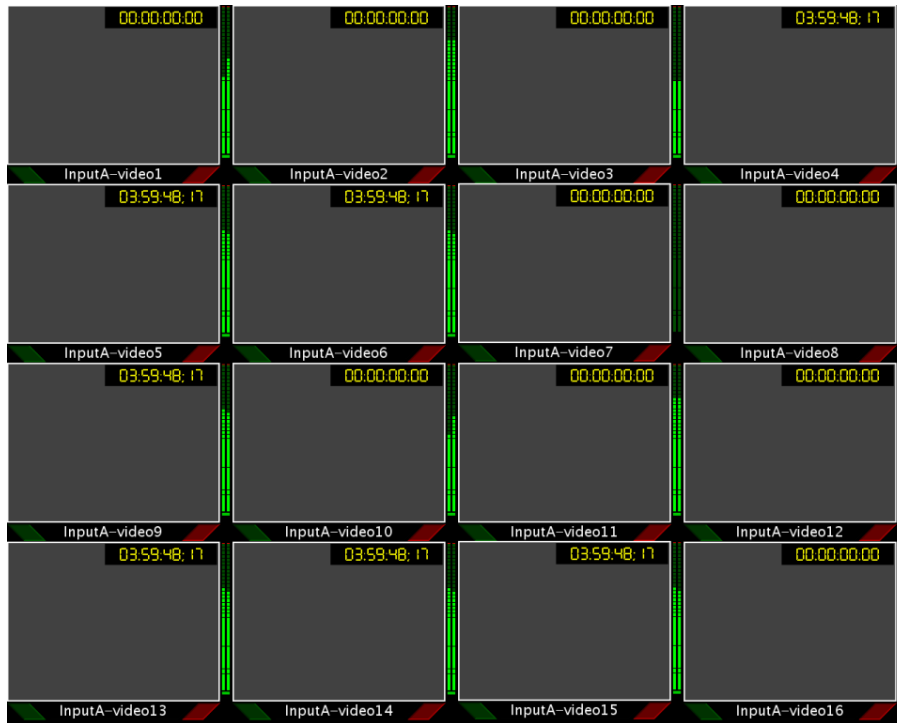

*Example of a default layout showing 16 video streams*

---

Note: You can also use the 10 LAYOUT PRESETS buttons on the Kaleido-RCP2 to load the preconfigured default layout to the monitor wall.

---



## Cabling Diagrams

### Kaleido-IP

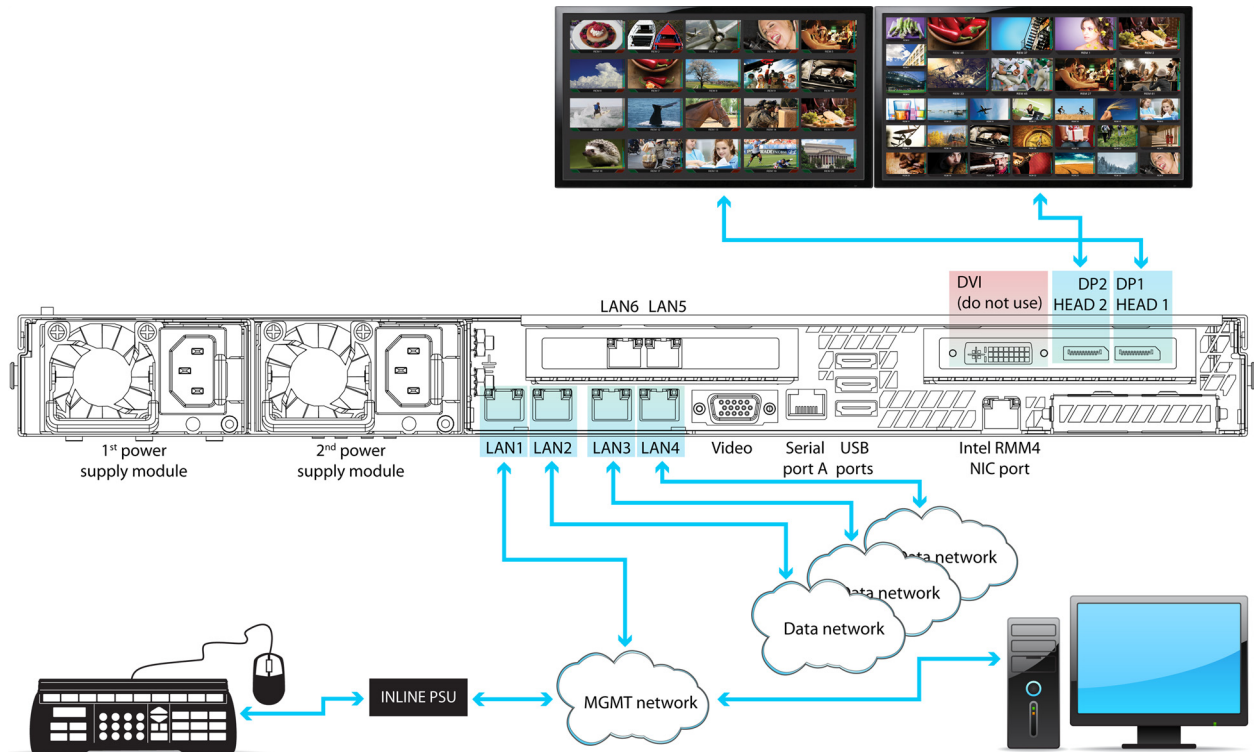

*Cabling diagram for a Kaleido-IP X310 with two additional DATA ports (LAN5–LAN6, not connected). The Kaleido-IP X110 rear panel is identical, except for LAN5 and LAN6, which are not available for this model.*

## Kaleido-MX

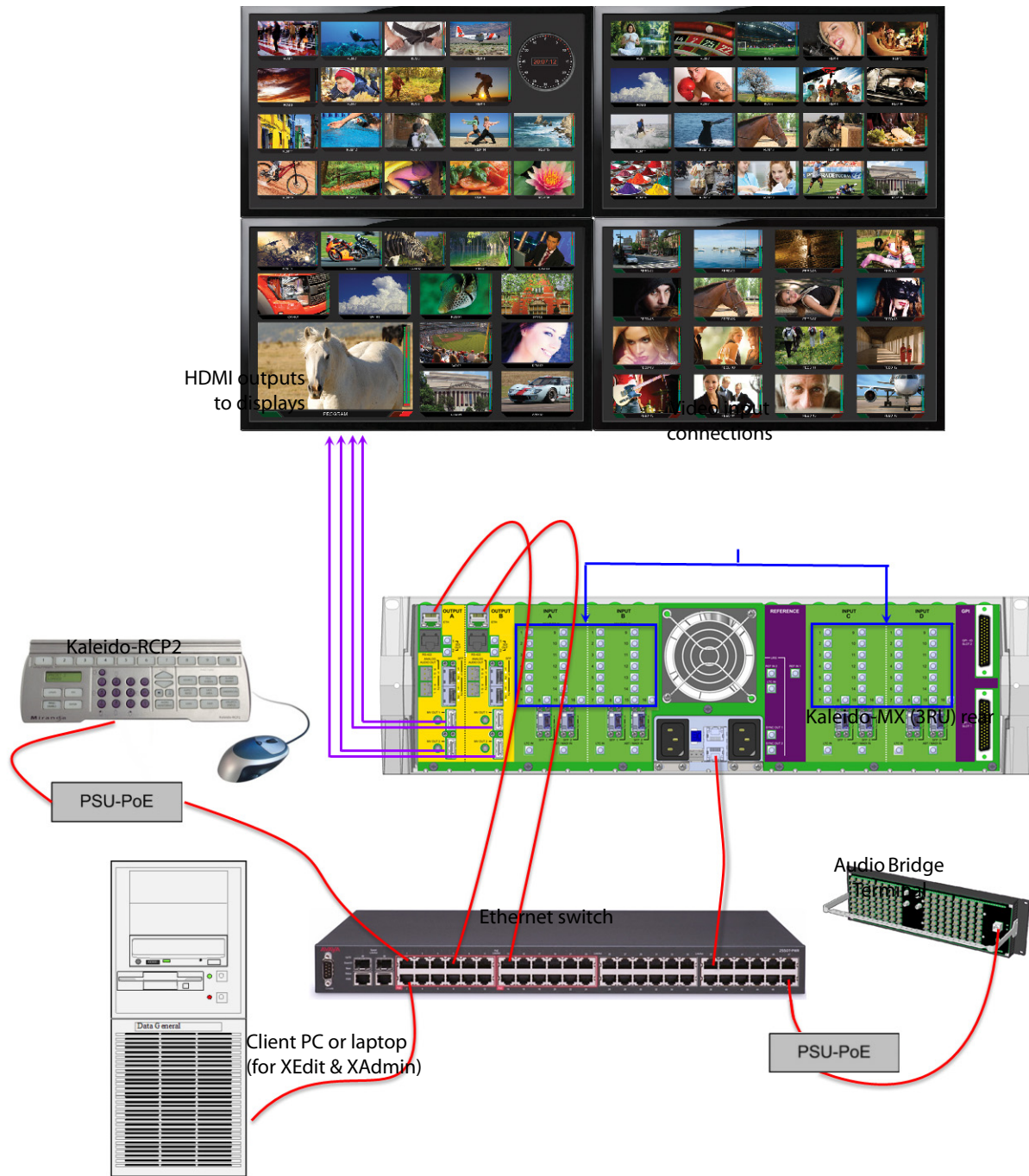

Cabling diagram, showing Kaleido-X (3RU) rear panel)

## KMV-3901/3911

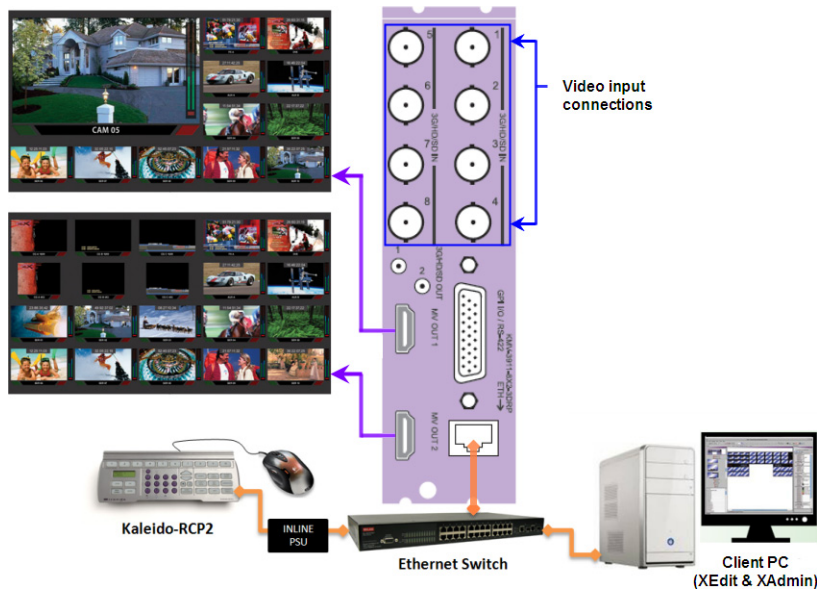

Cabling diagram showing KMV-3911 rear panel.

## Kaleido-X16

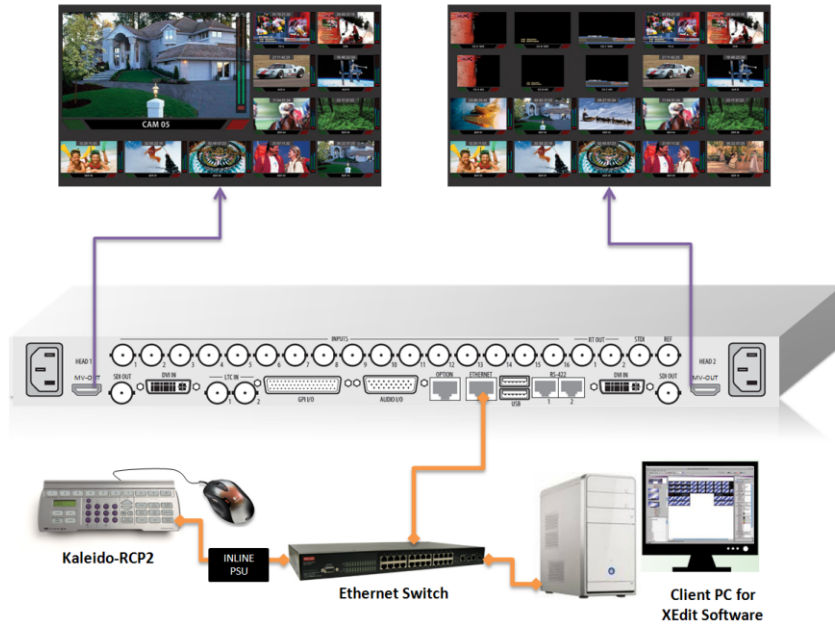

## Kaleido-X (4RU)

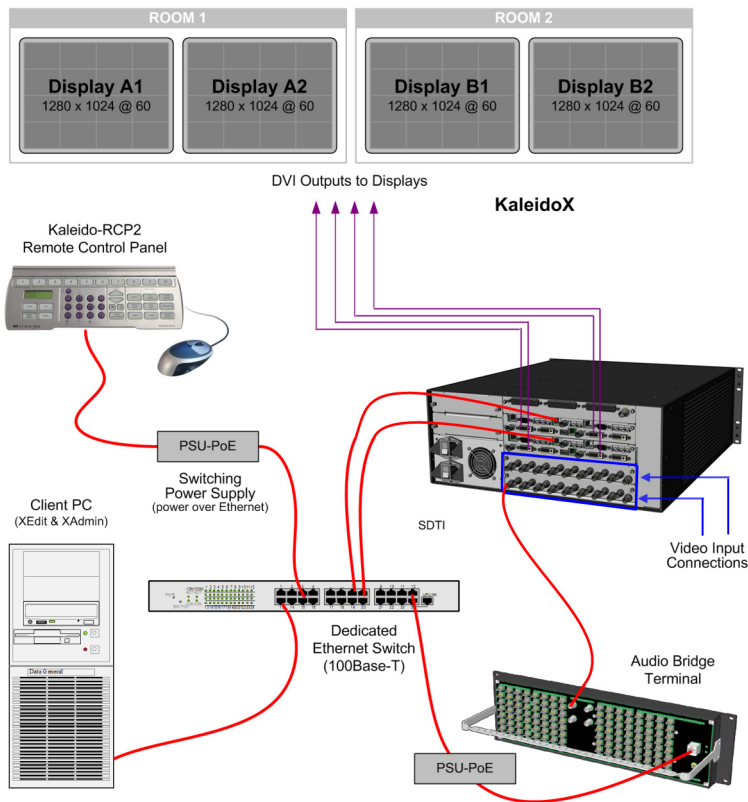

## Kaleido-X (7RU)

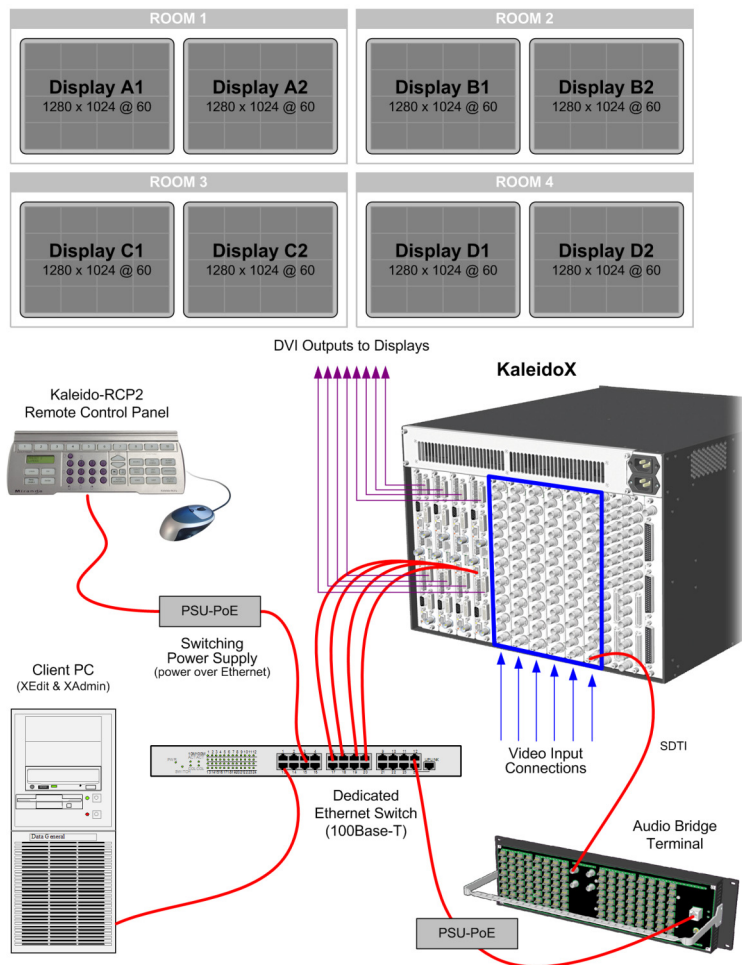

## Kaleido-X (14RU)

Refer to the "Kaleido-X (7RU) Expansion" chapter in the Kaleido-X (7RU) Hardware Description & Installation Manual.

## RS-422 Connection Diagram

Note: For information on the *KMV-3911* multiviewer's RS-422 interface, refer to the *KMV-3911 Guide to Installation and Operation*, available on the DVD that shipped with your system, and from Grass Valley's support portal.

In the case of a **Kaleido-X** multiviewer, each output card supports one RS-422 port over an RJ-45 connector. The **Kaleido-X16** supports two RS-422 serial inputs over RJ-45 connectors.

These inputs allow the multiviewer to connect to external serial devices such as a router, production switcher, or router controller.

**Note:** The RS-422 ports each have an RJ-45 connector in order to preserve space on a busy panel. The RS-422 interface specifies a DE-9 connector, so if you are using this interface, you will require a DE-9-to-RJ-45 adapter. Grass Valley supplies two adapter models, correctly wired for this application: a straight adapter (part no. 1737-3000-102), and a crossover adapter (part no. 1792-3700-100).

The pinout for the RS-422 signals at the RJ-45 connectors on a Kaleido-X16—or on the output cards’ rear panel, in the case of a Kaleido-X—, and the wiring diagrams for the appropriate adapters, are shown here:

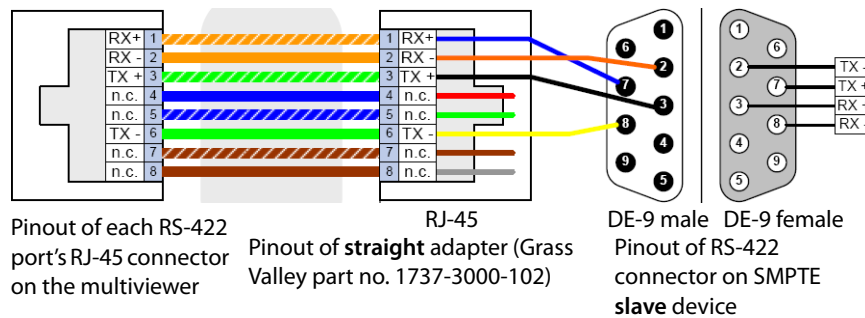

*Standard wiring between multiviewer and devices wired to SMPTE "slave" specification (e.g. most routers, Ross Synergy switchers, Neveon ETH-CON)*

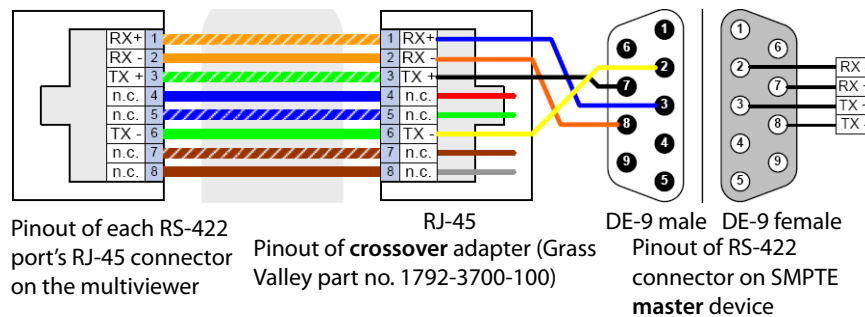

*Standard wiring between multiviewer and devices wired to SMPTE "master" specification (e.g. Philips Jupiter router control system, Miranda Presmaster PCS)*

**Note:** The two RS-422 ports on the multiviewer side have no ground pin. Using the appropriate DE-9S-to-RJ-45 adapter, an external device should be able to communicate with a multiviewer despite the lack of a ground.



## XEdit Application Shortcuts

The following is a list of shortcut keys available in XEdit to execute specific actions.

Action	Shortcut key
Save	Ctrl+S
Import sources from spreadsheet <sup>1</sup>	Ctrl+I
Toggle the status bar	Ctrl+Shift+B
Toggle the layout navigator	Ctrl+Shift+N
Toggle the grid	Ctrl+Shift+G
Toggle the Tools pane	Ctrl+Shift+T
Toggle the Properties pane	Ctrl+Shift+P
Toggle the Tips pane	Ctrl+Shift+H
Restore the factory audio scales	Ctrl+Shift+A
Restore the factory calibrations	Ctrl+Shift+C
Restore the factory resolutions	Ctrl+Shift+E
Restore the factory widget libraries	Ctrl+Shift+L
Undo last operation	Ctrl+Z
Redo last operation	Ctrl+Y
Cut	Ctrl+X
Copy	Ctrl+C
Paste	Ctrl+V
Delete selection	Delete
Duplicate	Ctrl+D
New	Ctrl+N
Open	Ctrl+O
Save as	Ctrl+Shift+S
Close	Ctrl+W
Create grid-type layout based on selection (Auto-layout)	Ctrl+M
Select all	Ctrl+A
Send to back	Ctrl+B
Send to front	Ctrl+R
Unlock composite	F2
Zoom in	Ctrl+plus sign
Zoom out	Ctrl+minus sign

1. Available for Kaleido-IP only (see [Importing a stream lineup](#), on page 95).





# 3 Operation of the Monitor Wall

This section introduces the Kaleido-X monitor wall features.

## Key Concepts

Monitor wall	The <i>monitor wall</i> refers to the group of display screens that are connected to the output modules of a specific Kaleido-X system.
Room	A <i>room</i> is a visual grouping of display screens. A room represents the physical displays, positioned and sized as viewed by the user in an actual room. Rooms can include <i>full screen zones</i> , and are defined and configured by using the XEdit application. See <a href="#">Logging on to the Monitor Wall Using a Remote Control Panel</a> on page 33.
Automatic resolution detection	<i>Automatic resolution detection</i> eases the initial setup of a new display monitor by automatically determining the best resolution supported by the display. This ensures that the multiviewer will be configured for the best video quality. When a new display is connected, the multiviewer will detect the EDID of the display on boot-up, and will set the correct resolution accordingly. This means that displays can be hot-swapped. If an existing display is replaced by a new one, the Kaleido-X will automatically change the resolution without the need for a system restart. See <a href="#">Setting a Display Monitor's Output Resolution</a> on page 64. Note: The Kaleido-IP does not yet support automatic output resolution detection.
Layout	A <i>layout</i> refers to a visual grouping of monitors on the monitor wall. Layouts are specific to a room, and created by using the XEdit application. Full screen layouts, also defined in XEdit, are specific to a full screen zone within a particular room. See <a href="#">Loading Layouts</a> on page 39, and <a href="#">Displaying a Source in Full Screen Mode</a> , on page 41.
Dashboard	The <i>dashboard</i> is a window that contains the system name, IP address and software build version. It also displays error messages. The dashboard is displayed at the bottom right of each display, on the monitor wall:  See <a href="#">Displaying the Dashboard</a> on page 37, and <a href="#">Hiding the Dashboard</a> , on page 38.
Monitor	A <i>monitor</i> (also called a <i>widget</i> ) is an element that is part of a layout. XEdit supports several types of primary elements (clocks, timers, video monitors, audio monitors, UMDs, time code monitors, alarm monitors, etc.), that can be grouped into composite monitors.

Logical source	A <i>logical source</i> (called a <i>channel</i> , in earlier versions of the documentation) refers to a group of physical audio, video, or metadata sources, and text attributes. A logical source can be used as a whole, and assigned to a virtual monitor. See <a href="#">Assigning Sources to Monitors</a> on page 51.
Video monitor	A <i>video monitor</i> is a layout element used to define an area for displaying a video signal. Within a video monitor, the <i>video window</i> is the active area where the video signal is displayed, possibly including closed captions or teletext. See <a href="#">Displaying Subtitles and Closed Caption Text</a> on page 45.
Composite monitor	A <i>composite monitor</i> (also referred to as a <i>composite</i> , a <i>monitor</i> or a <i>tile</i> ) is a group of primary elements that can be seen as a single object within a layout. Composite monitors typically include a video window, one or more audio level meters, and a UMD with two tallies.
Safe area	The <i>safe area</i> is a configurable region inside a video window. The safe area markers delimit this region (e.g. a 4:3 region inside a 16:9 window). See <a href="#">Toggling Safe Area Markers</a> on page 44.
Audio monitor	An <i>audio monitor</i> (also called <i>audio level meter</i> or <i>ALM</i> ) is a layout element that provides a visual representation of sound. See <a href="#">Triggering Audio Monitoring</a> on page 62.
UMD	An <i>under monitor display (UMD)</i> has a <i>text label</i> that can be static or dynamically updated by a peripheral device. It can also have <i>left and right tally indicators</i> . The UMD typically indicates the name of the video source seen in a video monitor. You can edit static labels directly on the monitor wall: see <a href="#">Editing UMD Text</a> , on page 50, and <a href="#">Selecting an Input Method</a> , on page 50.
Time code monitor	A <i>time code monitor</i> displays the Ancillary Time Code (ATC) from an HD video signal, or the time code found in an embedded SDI video signal, part of the vertical interval of an analog signal (VITC), or other external Linear Time Code (LTC). This monitor also supports time code information from external providers. Time code monitors can be used for monitoring the duration of programs.
Timer	A <i>timer monitor</i> is based on a <i>timer</i> defined within the Kaleido-X system. Three timer modes are available: (1) UP: timer counts up starting from zero up to a preset time, (2) DOWN: timer counts down from a preset time to zero, and (3) REMAINING: timer counts down from the current time until it reaches a preset time. Timers are defined and configured in XEdit. They can be slaved to production timers, assigned to logical sources, assigned to rooms or specific RCP users, and controlled from the Kaleido-RCP2. See <a href="#">Using Timers</a> on page 57.
Clock	A <i>clock</i> is the visual representation of time in a video or display. It can be based on a reference LTC signal or on the Kaleido-X system time. Clocks can be in a digital or analog format. Note: The KMV-3901/3911 supports digital clocks only.

Subtitling monitor	<p>A <i>subtitling monitor</i> defines an area for displaying subtitles extracted from a video signal. By using a subtitling monitor you can monitor subtitling from a specific DVB or SCTE 27 stream, independently from the associated video stream. Requires the <i>CC/XDS</i> option (see <a href="#">Hardware and Software Options</a>, on page 443). See <a href="#">Setting the DVB Subtitling Language from the Monitor Wall</a> on page 48, and <a href="#">Setting the SCTE 27 Subtitling Language from the Monitor Wall</a>, on page 48.</p> <p>Note: With the current version of the Kaleido-X software, the subtitling monitor supports DVB subtitles and SCTE 27 subtitles, from Kaleido-IP sources only.</p>
V-chip monitor	<p>The <i>V-chip monitor</i> provides a visual indication of the V-chip rating from the CC (608) metadata in an SD video signal, or from the CC (608) legacy caption data, when such data is present within an HD video signal. Requires the <i>CC/XDS</i> option (see <a href="#">Hardware and Software Options</a>, on page 443).</p>
Metadata monitor	<p>A <i>metadata monitor</i> defines an area for displaying XDS, or digital content advisory descriptor (CAD) information extracted from a video signal. Requires the <i>CC/XDS</i> option (see <a href="#">Hardware and Software Options</a>, on page 443).</p>
Action	<p>An <i>action</i> is an operation automatically performed in response to a specific trigger. <i>Monitor wall actions</i> are directly associated with layout elements. <i>Background (floating) actions</i> are actions that are global to the Kaleido-X system. Unlike monitor wall actions, background actions are always available. See <a href="#">Triggering Actions</a> on page 60.</p>
Trigger	<p>A <i>trigger</i> is an event that triggers an action. An example of a trigger could be a double click on a monitor. Background actions are triggered by alarms or by Gateway commands. In XEdit, when defining an action for a layout element, you could specify, for instance, that a specific full screen layout be displayed on the monitor wall in response to the trigger.</p>
Alarm monitor	<p><i>Alarm monitors</i> help you see the status of global and virtual alarms, but their use is not limited to this type of alarms. When any alarm level is assigned to an alarm monitor, the status of this alarm will be shown. When using the global alarm at the text label level, it will display the text value of the alarm, which is a readable name.</p>
Alarm latch	<p>To prevent operators from missing temporary alarms on the monitor wall, layout elements that are capable of displaying an alarm status (e.g. video monitors, subtitling monitors, UMDs, alarm monitors) can be configured with a latching mechanism. An <i>alarm latch</i> will keep the error state visible until someone acknowledges the associated alarm. See <a href="#">Acknowledging Alarms</a> on page 61.</p> <p>When you acknowledge an alarm, latched or current, the latched status is reset to normal (i.e. unlatched). If the alarm is acknowledged while its status indicates an error condition, the latched status is reset to normal, and will only go back to error if the alarm status returns to normal and then to error again.</p>

Note: If you have an iControl application server, you may use its GSM alarm browser to configure an *acknowledgement snooze duration*, which defines the period during which alarm status changes detected by your multiviewer are ignored, immediately after an alarm is acknowledged. Such a snooze period is typically not desirable in the context of multiviewer alarms. Therefore, a multiviewer's GSM has its acknowledgement snooze duration set to 0 ms, by default.

Video monitors can provide alarm status information through their borders' color and blinking behavior, and show the latched state as small indicators in each corner of the video window. UMDs (text and tallies) and alarm monitors can change their text or background color and blinking behavior, to reflect the alarm status and show the latched state through their borders.

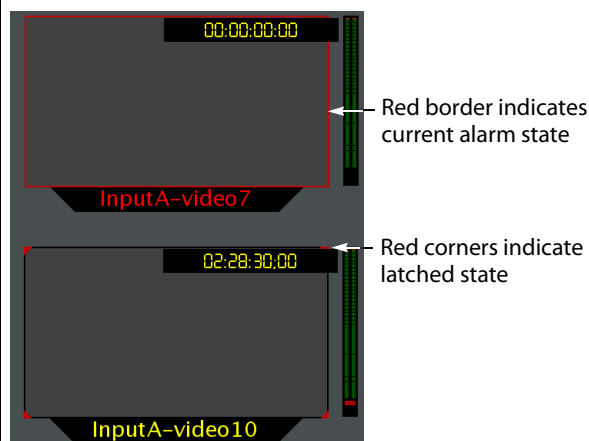

See [Configuring a Video Monitor's Alarm Reporting Behavior](#) on page 245, [Configuring a UMD's Alarm Reporting Behavior](#), on page 268, and [Configuring Alarm Monitors](#), on page 274, for details on configuring the alarm reporting and latching attributes for these layout elements.

The Kaleido-X system tracks the latched state of all alarm levels in a logical source at all times, even when alarms are not being monitored on the wall, or via SNMP traps or background actions. It could thus happen that some layout elements will show a latched status indicator after a layout is loaded, even if the current state of the corresponding alarm is normal and the alarm was not monitored in the previous layout (the alarm occurred on the feed while the feed was not monitored).

	<ul style="list-style-type: none"> <li>• Latching only occurs when an alarm severity is above normal (i.e. minor, major, or critical). All other alarm states (unavailable, unassigned, pending, unknown, etc.) are not latched.</li> <li>• Unlatching a global alarm unlatches all its contributing alarms. Unlatching the last alarm contributing to a global alarm unlatches the global alarm itself.</li> <li>• The color of the latch indicator reflects the highest level of alarm received since the corresponding alarm was last unlatched.</li> </ul>
Crosspoint	<p>A multiviewer can control upstream routers, and it can also be controlled as a router itself. In addition, some multiviewer models—Kaleido-X16, Kaleido-X (7RU), and Kaleido-X (14RU)—can have optional router outputs. A crosspoint is the link inside a router between a source (input) and a destination (output). See <a href="#">Changing Crosspoints</a> on page 54.</p> <p>Note: As of Kaleido-X version 5.20, the preferred method of controlling sources, regardless of whether they are sources from an upstream router or physical multiviewer inputs, is to configure logical sources.</p>

## Detailed Directions

This section describes the actions you can perform on the Kaleido-X monitor wall.

### Logging on to the Monitor Wall Using a Remote Control Panel

As network devices, the RCP-200 advanced remote control panel, and the Kaleido-RCP2 control panel provides access to any room, from any Kaleido-X system on the network. As a security measure, access is controlled by a login procedure. Multiple RCP-200 and Kaleido-RCP2 can be used by different users to access the same room concurrently. When multiple RCP users are active in the same room, they each control a separate pointer on the monitor wall, and can use the monitor wall menu independently, as long as they limit their actions to separate displays.

In a default system configuration, a multiviewer's video outputs are assigned to specific rooms:

- On a Kaleido-X (7RU), the two DVI/VGA outputs from each of the dual-head Output cards A, B, C and D are assigned to ROOM1, ROOM2, ROOM3 and ROOM4 respectively.
- On a Kaleido-X (4RU), the two DVI/VGA outputs from each of the dual-head Output cards A and B are assigned to ROOM1 and ROOM2 respectively.
- On a Kaleido-X (14RU) expansion system, the two DVI/VGA outputs from each of the dual-head Output cards A, B and C of each of Frame A and Frame B are assigned to ROOM1, ROOM2, ROOM3, ROOM4, ROOM5 and ROOM6 respectively.
- On a Kaleido-X16-D, the HDMI outputs from each of the Output modules are assigned to ROOMX16.
- On a Kaleido-X16-S, the HDMI output is assigned to ROOMX16.
- On a KMV-3901/3911, Kaleido-XQUAD, or Kaleido-XQUAD-DUAL, the HDMI outputs are assigned to ROOM1.
- On a Kaleido-IP, the multiviewer outputs are assigned to ROOM.
- On a Kaleido-MX, or Kaleido-Modular-X, the HDMI outputs are assigned to ROOM1.

## Logging on to the Monitor Wall Using the Kaleido-RCP2

### To log on to a Kaleido-X room from the Kaleido-RCP2

- 1 On a Kaleido-RCP2 with an active connection to the network, press and hold the ENTER button until the ESC button lights up. The **Configuration** menu appears, with the ROOM SELECTION option displayed.
- 2 Press ENTER again to obtain the list of rooms from the Kaleido-X systems that are currently available on the network.  

The rooms are listed in the form [multiviewer name]/[room name]. If a room belongs to a cluster system, its name appears once for each of the member multiviewers (e.g. if two multiviewers, KX1 and KX2, are configured as a cluster, and ROOM1 includes displays fed by both multiviewers, then both KX1/ROOM1 and KX2/ROOM1 will be listed. You may select either one.
- 3 In the room list, select the room you wish to access by pressing the **2** key (to move up in the list) or the **8** key (to move down the list).
- 4 When the appropriate room name is highlighted, press ENTER to accept the new selection, and then press ESC to exit the **Configuration** menu.
- 5 Press the LOGIN key.  

The following message will appear on the LCD display:

LOGIN Position  
Admin
- 6 Select your user name by pressing the **2** key (to move up in the list) or the **8** key (to move down the list).
- 7 When your user name is highlighted, press ENTER.
- 8 When prompted, type the password for this user name, then press ENTER.

---

**Note:** By default, the user "Admin" has no password.

---

The message "Access granted" will appear on the LCD display if the login is successful. If a mouse is connected to the Kaleido-RCP2, then you should be able to see and move the mouse pointer on the monitor wall. Alternatively, use the Kaleido-RCP2's mouse-function keys.

---

### Notes

- If at any time the message "Target system is offline" or "No login list available" appears on the LCD display, press the ESC, ENTER and DEL keys simultaneously and go back to [step 1](#).
  - If the room you were logged on to is part of a cluster system, try accessing it from a different multiviewer (e.g. select KX2/ROOM1 instead of KX1/ROOM1, from the room list).
  - The pointer may flicker when two RCP users access displays fed by the same multiviewer output.
  - Two users accessing the same display will be limited to sharing a single pointer.
-

For more information on the Kaleido-RCP2, please refer to the *Kaleido-RCP2 Guide to Installation and Operation*, available on the DVD that shipped with your system, and from Grass Valley's support portal.

## Logging on to the Monitor Wall Using the RCP-200

### To log on to a Kaleido-X room from the RCP-200

- 1 On an RCP-200 with an active connection to the network, press the LIST button.

All devices, and Kaleido-X rooms, detected by the RCP-200 appear on the left screen. Kaleido-X rooms are listed in the form [multiviewer name]\[room name].

If a room belongs to a cluster system, its name appears once for each of the member multiviewers (e.g. if two multiviewers, KX1 and KX2, are configured as a cluster, and ROOM1 includes displays fed by both multiviewers, then both KX1\ROOM1 and KX2\ROOM1 will be listed. To determine the one you should select, review the following:

- Has the RCP user configuration you wish to use been replicated on every member of the cluster (see [Replicating RCP Users Across a Cluster System](#), on page 93)?
- Do you need to control an external router whose configuration is available only from one or some specific members of the cluster?
- Does your system configuration include actions that were configured only on one or some specific members of the cluster?
- Do you need to control a timer from the monitor wall in a cascade room?

If any of the above elements is available only from one or some specific members, then make sure you select the room name prefixed with the appropriate multiviewer name. In the case of a cascade room, unless you remember which multiviewer you were connected to when you added the timer you need to control, you will have to proceed by trial and error.

- 2 Touch the room you wish to access (press the DOWN or UP soft keys to scroll the list as needed).
- 3 If the list of users assigned to this room appears on the right-hand screen, touch the user name under which you wish to log on, enter your password, and then touch LOG IN.

---

**Note:** By default, the user "Admin" has no password.

---

The room's monitor wall control panel appears on the right-hand screen, with the ASSIGN CHANNEL category selected. If a mouse is connected to the RCP-200, then after

touching WALL MOUSE you should be able to see and move the mouse pointer on the monitor wall.

---

#### Notes

- If the ROUTER SELECT category becomes selected instead of ASSIGN CHANNEL, showing the following message on the right-hand screen: “Please select a router from the left-hand screen,” then you still need to complete the correlation between some monitor wall destinations and the representation of the corresponding KX Router logical router. See [Correlating Monitor Wall Destinations and KX Router Logical Routers for the RCP-200](#) on page 466.
  - The RCP-200 will remember your user credentials until you log out explicitly (by touching LOG OUT at the upper-right corner of the control panel).
  - The pointer may flicker when two RCP users access displays fed by the same multiviewer output.
  - Two users accessing the same display will be limited to sharing a single pointer.
- 

For more information on the RCP-200, please refer to the *RCP-200 Guide to Installation and Operation*, available on the DVD that shipped with your system, and from Grass Valley's support portal.

## Using On-Screen Wall Control

### Locating the Mouse Pointer on the Monitor Wall

If you have a cluster system, the monitor wall may comprise a large number of display screens, where the mouse pointer location is not always obvious.

#### To locate the mouse pointer on the monitor wall

- Click the middle mouse button.  
A more recognizable square shape appears around the pointer.

---

**Note:** Configuring a larger pointer may also help. See [Enabling the Large Mouse Pointer for a Room](#) on page 315, for details.

---

### Using On-Screen Wall Control from the RCP-200

Once you have logged on to a room from the RCP-200 control panel, a mouse connected to one of the panel's USB port automatically switches to the monitor wall, while the RCP-200's touch screen features remain available. You can alternate using the mouse between the RCP-200's right-hand screen, and the monitor wall.

#### To use the mouse on the RCP-200's right-hand screen

- Touch the WALL MOUSE category.  
The category's background turns a darker shade (purple), and the mouse pointer appears on the RCP-200's right-hand screen.



#### To use the mouse on the monitor wall

- Touch the WALL MOUSE category.  
The category's background turns a lighter shade (mauve), and the mouse pointer appears on the monitor wall.

#### Synchronizing the RCP-200's Head View with the Monitor Wall

The RCP-200's Kaleido-X control panel does not automatically reflect changes to the current layout that were not performed from the RCP-200—for example, someone may have loaded a different layout, or changed assignments, from another control panel, from XEdit, or by using the monitor wall mouse.

#### To synchronize the RCP-200's head view with the monitor wall

- Press the REFRESH knob.

## Displaying the Dashboard

Whenever the Kaleido-X software detects an error, it will automatically display the dashboard on every monitor of the monitor wall. When all errors are resolved, then the system automatically closes the dashboard on every monitor. You can also display the dashboard as needed, to view your multiviewer's system name, IP address, software version and current error messages. In such cases you must close the dashboard manually.

---

**Note:** It is possible to disable the automatic display of the dashboard on specific displays. See [Disabling the Dashboard](#) on page 210 for details on how to configure this option.

---

#### To display the dashboard

- 1 Right-click a monitor. On the menu, point to **Monitor wall**, and then click **Show dashboard** to display the dashboard associated with the current head.

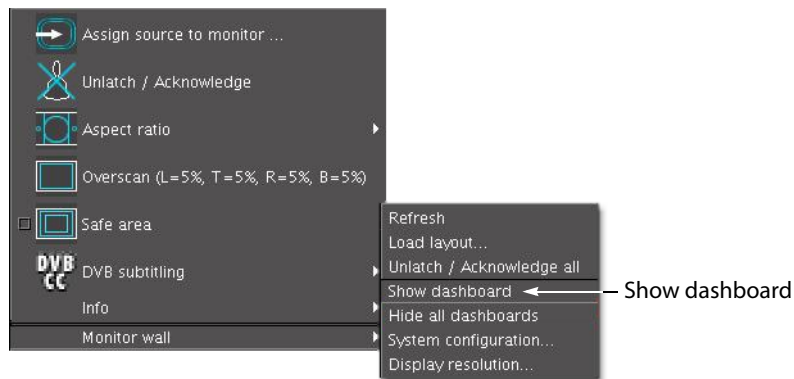

Monitor wall menu (from composite monitor menu)

**Note:** If you right-click the monitor wall background directly, then the monitor wall menu appears immediately, and you can click **Show dashboard** directly:

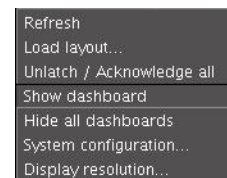

After a brief delay, the dashboard appears at the bottom-right corner of the display monitor, and the command **Hide dashboard** replaces **Show dashboard** on the menu.



Dashboard on the monitor wall

## Hiding the Dashboard

### To hide the dashboard

- Click the x button at the bottom-right corner of the dashboard. Alternatively, right-click anywhere on the monitor wall, point to **Monitor wall** on the menu (if you clicked a layout element), and then click **Hide dashboard** to hide the dashboard on the current display.

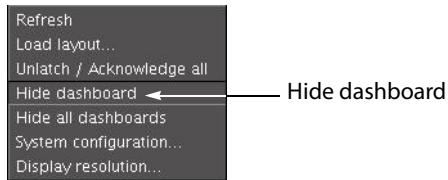

---

**Note:** Clicking the x button closes the dashboards on every display monitor in the room if they were displayed automatically.

---

### To hide all the dashboards

- Right-click anywhere on the monitor wall, point to **Monitor wall** on the menu (if you clicked a layout element), and then click **Hide all dashboards** to hide the dashboard on every display in the room.

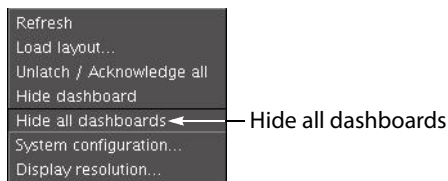

---

**Note:** When a dashboard is closed while the system is in an error condition, it will automatically reappear after 60 minutes, or when a new error occurs.

---

## Loading Layouts

---

**Note:** Due to a limitation in XEdit's support for drag-and-drop operations, when you first load a new layout on the monitor wall, you may notice that a monitor's source or destination assignment is incorrect. Open the layout in XEdit, click the corresponding monitor, verify the **Source** and **Monitor wall destination** attributes indicated in the **Properties** pane, and correct them as needed. See [Assigning Logical Sources or Monitor Wall Destinations to Monitors](#) on page 232.

---

### Loading a Layout by Using the Mouse

#### To load a layout on the monitor wall, by using the mouse

- 1 Right-click anywhere on the monitor wall, point to **Monitor wall** (if you clicked a layout element), and then click **Load layout** on the menu.

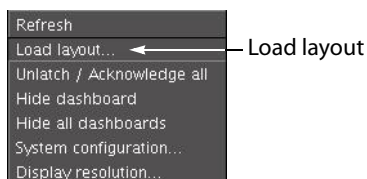

The layout chooser appears.

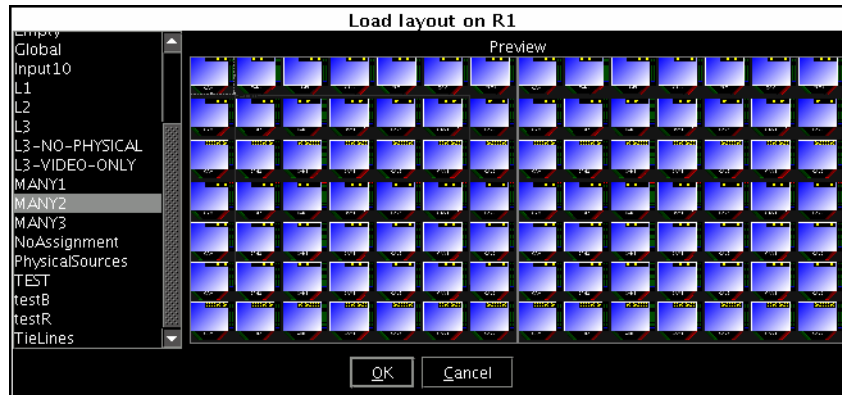

- 2 Select the layout you wish to load, from the set of layouts defined for this room, and then click **OK**.

The new layout appears on the monitor wall.

### Loading a Layout by Using the Kaleido-RCP2

To load a layout on the monitor wall, by using the Kaleido-RCP2

- 1 Press **LOAD** on the Kaleido-RCP2.

The layout chooser appears.

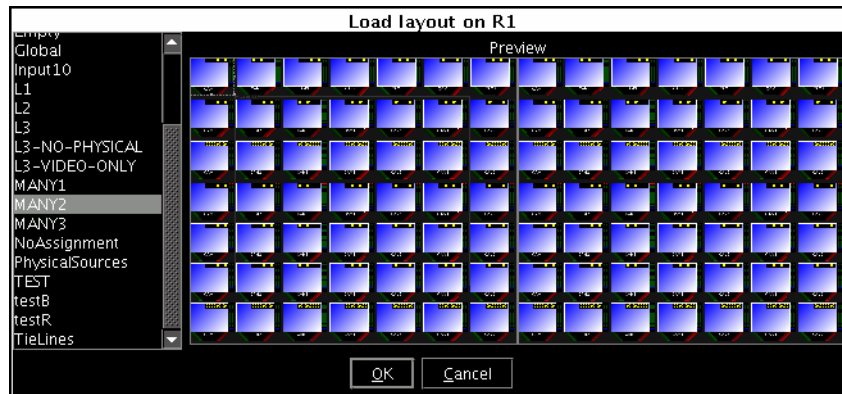

- 2 Select the layout you wish to load, from the set of layouts defined for this room, and then click **OK**.

The new layout appears on the monitor wall.

### Using Layouts Presets

To load a layout using the Kaleido-RCP2's preset buttons

- Press the appropriate preset button (1-10) on the Kaleido-RCP2.

The button you just pressed starts flashing (while the button associated with the currently loaded layout, if any, remains lit). Once the layout associated with the preset button for the current user appears on the monitor wall, the button stops flashing, and becomes lit (while the previously lit button is not lit anymore). See [Assigning Room](#)

[Layouts to the Kaleido-RCP2 Preset buttons](#) on page 314, for more information.

**Note:** Once the preset button has stopped flashing on the Kaleido-RCP2, if the new layout has source assignments from an upstream router, it may still take a moment before these sources appear on the monitor wall.

## Loading a Layout by Using the RCP-200

### To load a layout on the monitor wall, by using the RCP-200

- 1 Touch LAYOUT SELECT on the RCP-200's right-hand screen.  
The layout chooser view appears.
- 2 Rotate the TAKE knob to locate the layout you wish to load, scrolling the list as needed.
- 3 Once you have selected the layout you wish to load, press TAKE.  
After a moment, the new layout appears on the monitor wall, and the RCP-200's right-hand screen returns to the ASSIGN CHANNEL panel.

## Refreshing a Layout

### To refresh a layout

- Right-click anywhere on the monitor wall, point to **Monitor wall** (if you clicked a layout element), and then click **Refresh** on the menu.

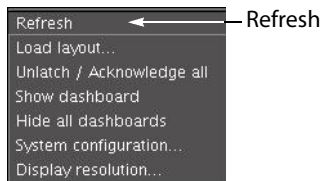

## Displaying a Source in Full Screen Mode

### To display a source in full screen mode from the Kaleido-RCP2

- 1 Move the pointer over the video source you wish to display in full screen mode.
- 2 Press FULL SCREEN on the Kaleido-RCP2.  
The full screen layout assigned to the current user is loaded into the full screen zone.

### To display a source in full screen mode from the RCP-200

- 1 Touch the WALL MOUSE category if it is not already selected, and then move the pointer over the video source you wish to display in full screen mode on the monitor wall.
- 2 If you have yet to assign the FULL SCREEN wall function to one of the programmable knobs, rotate the knob you wish to program until FULL SCREEN is selected, and then press the knob.  
FULL SCREEN appears above the programmed knob.
- 3 Press the FULL SCREEN knob.  
The full screen layout assigned to the current user is loaded into the full screen zone.

### To close the full screen view

- Move the pointer over the full screen zone, and then press FULL SCREEN again, on the Kaleido-RCP2 or RCP-200.

---

Note: A full screen layout can also be loaded by configuring actions in XEdit. See [Managing Layouts](#) on page 223, for information on creating a full screen layout, and refer to [Creating Actions](#), on page 301, for detailed instructions.

---

## Changing a Source's Aspect Ratio

### To change the aspect ratio using the Kaleido-RCP2

- Move the pointer over the video source whose aspect ratio you wish to change, and then press ASPECT RATIO on the Kaleido-RCP2. Continue pressing ASPECT RATIO to alternate between the available aspect ratio options (4:3, 16:9, and possibly a third custom aspect ratio if one was defined in XEdit for the monitor).

### To change the aspect ratio using the RCP-200

- 1 Touch the WALL MOUSE category if it is not already selected, and then move the pointer over the video source whose aspect ratio you wish to change on the monitor wall.
- 2 If you have yet to assign the ASPECT RATIO wall function to one of the programmable knobs, rotate the knob you wish to program until ASPECT RATIO is selected, and then press the knob.  
ASPECT RATIO appears above the programmed knob.
- 3 Press the ASPECT RATIO knob.  
The video source's aspect ratio changes. Continue pressing ASPECT RATIO to alternate between the available aspect ratio options (4:3, 16:9, and possibly a third custom aspect ratio if one was defined in XEdit for the monitor).

### To change the aspect ratio using the mouse

- 1 Right-click the video source.
- 2 On the menu, point to **Aspect Ratio**, and then click **4:3** or **16:9**.

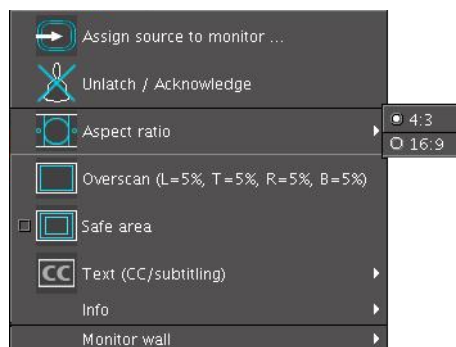

---

Note: There may be one more choice on the menu if you set a custom aspect ratio in XEdit, for this monitor. See [Setting a Video Monitor's Aspect Ratio](#) on page 238.

---

The video is resized accordingly within the layout.

## Video Cropping/Zooming

### To toggle the cropping mode using the Kaleido-RCP2

- To change the current cropping mode, move the mouse pointer over the video source whose cropping mode you wish to change, and then press the UNDERSCAN button on the Kaleido-RCP2. Continue pressing UNDERSCAN to alternate between underscan and overscan mode.

### To toggle the cropping mode using the RCP-200

- 1 Touch the WALL MOUSE category if it is not already selected, and then move the pointer over the video source whose cropping mode you wish to change on the monitor wall.
- 2 If you have yet to assign the UNDERSCAN wall function to one of the programmable knobs, rotate the knob you wish to program until UNDERSCAN is selected, and then press the knob.

UNDERSCAN appears above the programmed knob.

- 3 Press the UNDERSCAN knob.

The video source's cropping mode changes. Continue pressing UNDERSCAN to alternate between underscan and overscan mode.

### To toggle the cropping mode using the mouse

- Right-click the video source.

If the video is in underscan mode, then the menu will allow you to change to overscan.

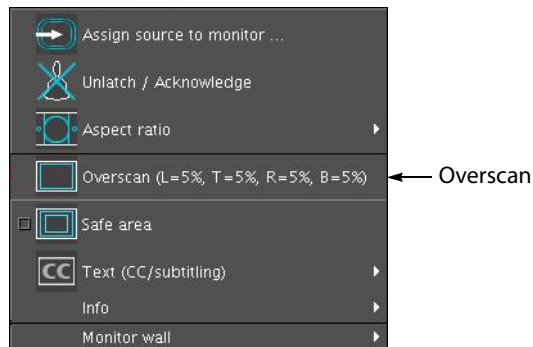

If the video is in overscan mode, then the menu will allow you to change to underscan.

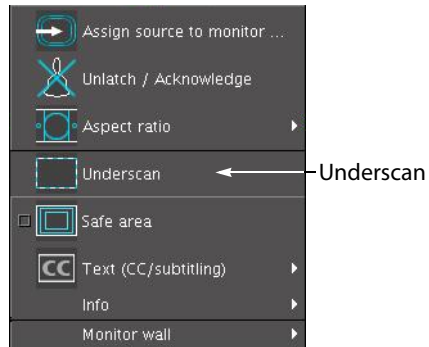

---

### Notes

- The Kaleido-IP does not yet support cropping and zooming.
  - The overscan margins are set to 5% by default. They can be customized in XEdit (see [Cropping Mode](#), on page 220).
  - Safe title area and aspect ratio markers follow the video signal (e.g. if the safe title area is within 5% of top, left, right and bottom, then when the video is in default overscan mode, the safe title area markers will not appear).
- 

## Toggling Safe Area Markers

### To toggle the safe area markers on a video using the Kaleido-RCP2

- Move the pointer over the video source, and then press SAFE AREA on the Kaleido-RCP2. Continue pressing SAFE AREA to toggle the markers.

### To toggle the safe area markers on a video using the RCP-200

- 1 Touch the WALL MOUSE category if it is not already selected, and then move the pointer over the video source whose cropping mode you wish to change on the monitor wall.
- 2 If you have yet to assign the SAFE AREA wall function to one of the programmable knobs, rotate the knob you wish to program until SAFE AREA is selected, and then press the knob.  
SAFE AREA appears above the programmed knob.
- 3 Press the SAFE AREA knob.  
The safe area markers appear inside the video window. Continue pressing SAFE AREA to toggle the markers.

### To toggle the safe area markers on a video using the mouse

- 1 Right-click the video source, and then click **Safe Area** on the menu.



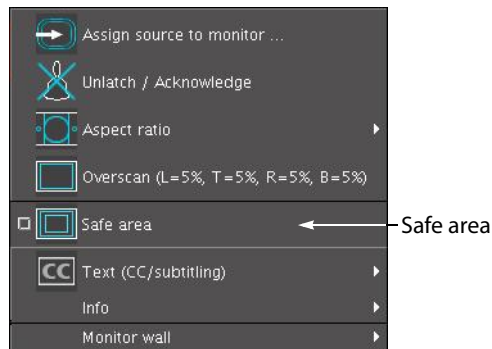

The safe area markers appear inside the video window.



- 2 Click **Safe Area** again on the menu, to hide the markers.

## Displaying Subtitles and Closed Caption Text

### Notes

- The KMV-3901/3911, and Kaleido-XQUAD multiviewers do not support extraction of subtitles and closed captions.
- Only the Kaleido-IP supports extraction of SCTE 27 subtitles, DVB subtitles, and DVB teletext.
- The Kaleido-IP supports extraction of CEA-608 and CEA-708 closed captions, in addition to DVB subtitles, DVB teletext, and SCTE 27 subtitles.

### Setting the Text Mode

#### To change the text mode for a video, or subtitling monitor

- 1 Right-click the appropriate video, or subtitling monitor, on the monitor wall.
- 2 If the current text mode indicator is **Text (CC/subtitling)**, then:
  - a Click **Enable text** on the menu, to first enable the display of subtitles and closed captions.

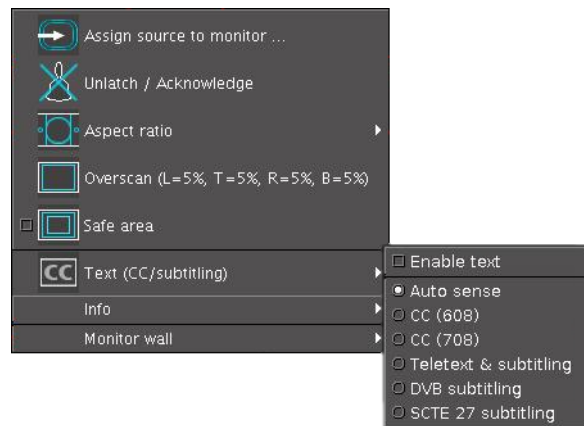





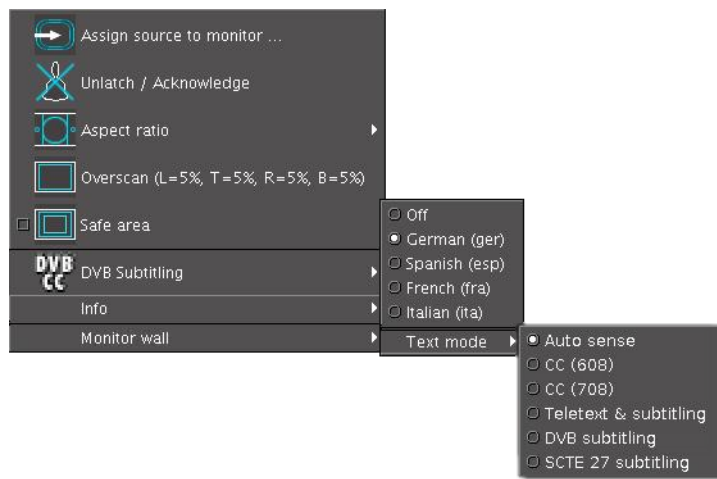

b Right-click the monitor again.

- 3 On the menu, point to the text mode indicator —either **Text (CC/subtitling)**, **CC (608)**, **CC (708)**, **Teletext & subtitling**, **DVB subtitling**, or **SCTE 27 subtitling**, then point to **Text mode**, and click the text mode you wish to apply.



To prevent the menu from being too crowded by CC (608), CC (708), DVB subtitling, SCTE 27 subtitling, and Teletext/subtitling options, its content (label, icon and available choice) changes, depending on the current video format:

Signal type	Text Mode	Indicator	Label	Available choices
SD-SDI/CVBS 525, MPEG-2, H.264	Auto		<b>CC (608)</b>	<b>Off, CC1, Text mode</b> sub-menu
Any	CC (608)			
SD-SDI/CVBS 625, MPEG-2, H.264	Auto		<b>Teletext &amp; subtitling</b>	For a Kaleido-IP: <b>Off, Page A to Page H, Text mode</b> sub-menu
Any	Teletext & subtitling			Other multiviewer models: <b>Off, Page A, Edit pages, Text mode</b> sub-menu

Signal type	Text Mode	Indicator	Label	Available choices
HD-SDI, MPEG-2, H.264	Auto		CC (708)	<b>Off, Service 1 to Service 63, Text mode sub-menu</b>
Any	CC (708)			
MPEG-2, H.264	Auto		DVB subtitles	<b>Off, available language services, Text mode sub-menu</b>
Any	DVB subtitles			
MPEG-2, H.264	Auto		SCTE 27 subtitles	<b>Off, available language services, Text mode sub-menu</b>
Any	SCTE 27 subtitles			
Other / Unknown	Auto		Text (CC/subtitles)	<b>Enable text, Auto sense, CC (608), CC (708), Teletext &amp; subtitles, DVB subtitles, SCTE 27 subtitles.</b>

### Switching Closed Captioning On/Off

#### To switch CC (608) closed captioning on/off

- Right-click the appropriate composite or video monitor on the monitor wall, point to **CC (608)**, and then click either **CC1** or **Off**.

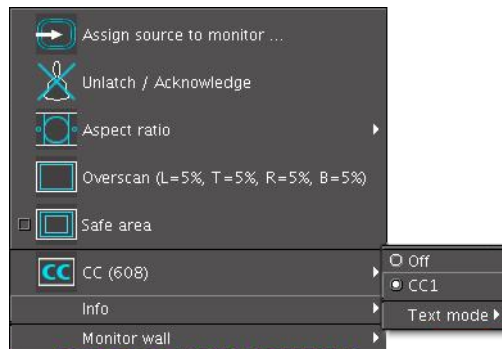

#### To switch CC (708) closed captioning on/off

- Right-click the appropriate composite or video monitor on the monitor wall, point to **CC (708)**, and then click either the appropriate service number or **Off**.

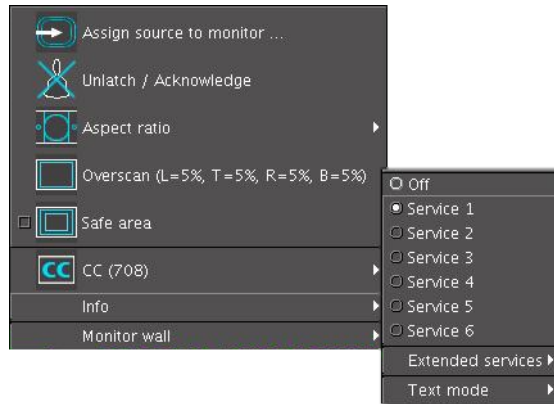

---

**Note:** The menu displays **Service 1** to **Service 6**. Use the **Extended services** sub-menu to select from the **Service 7** to **Service 63** range. When an extended service is enabled it is added to the menu below **Service 6**.

---

### Setting the DVB Subtitling Language from the Monitor Wall

To set the decoded DVB subtitling language for a monitor on the wall

- Right-click the appropriate composite, video, or subtitling monitor, point to **DVB subtitling**, and then click the language you wish to monitor.

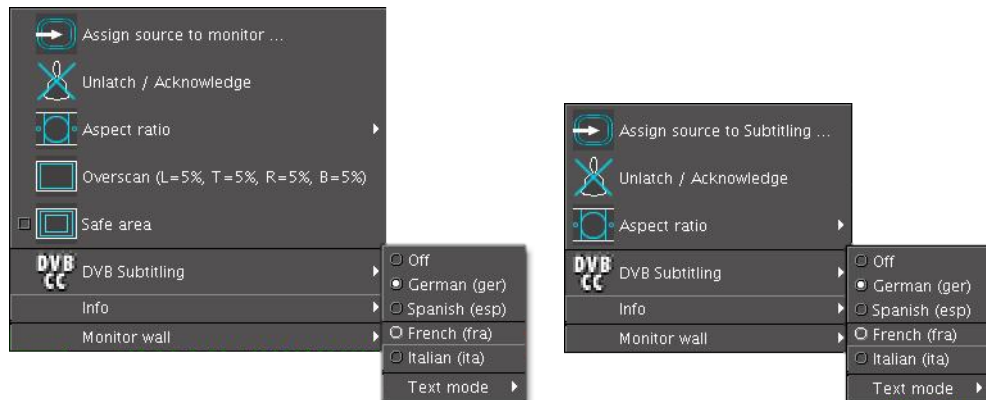

---

**Note:** When monitoring a program that includes DVB subtitling based on a non-supported version of ETSI EN 300 743, the Kaleido-IP raises the *DVB subtitle invalid* alarm and no subtitling appears on the monitor wall.

---

To switch DVB subtitling off

- Right-click the monitor, point to **DVB subtitling**, and then click **Off**.

### Setting the SCTE 27 Subtitling Language from the Monitor Wall

To set the decoded SCTE 27 subtitling language for a monitor on the wall

- Right-click the appropriate composite, video, or subtitling monitor, point to **SCTE 27 subtitling**, and then click the language you wish to monitor.

### To switch SCTE 27 subtitling off

- Right-click the monitor, point to **SCTE 27 subtitling**, and then click **Off**.

### Selecting a Teletext/Subtitling Page from the Monitor Wall

#### To change the decoded teletext/subtitling page for a Kaleido-IP

- Right-click the appropriate composite or video monitor, point to **Teletext & Subtitling**, and then click the page you wish to decode on the menu.

The menu displays **Page A (###)** to **Page H (###)** where “###” is the number of the actual page being monitored (from 100 to 899), or the word *Disabled* (if the page number associated with this page is not to be monitored).

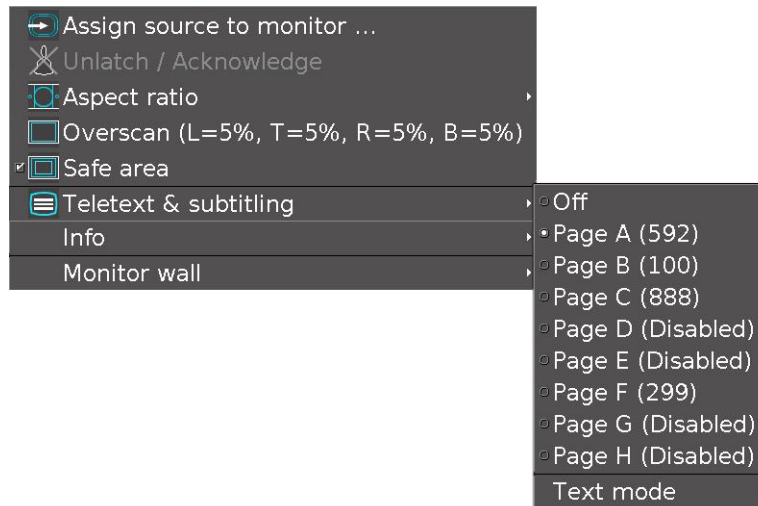

The assignments of Page A to Page H are configured in XEdit.

#### To change the decoded teletext/subtitling page for a Kaleido-X, Kaleido-X16, Kaleido-MX, or Kaleido-Modular-X

- Right-click the appropriate composite or video monitor, point to **Teletext & Subtitling**, and then click **Page A ([page number])** on the menu.

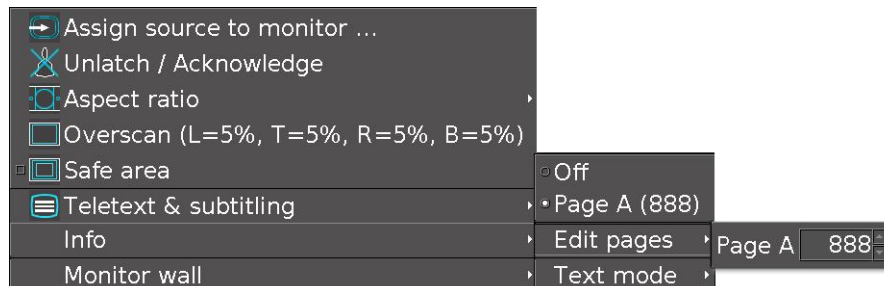

The menu displays **Page A (###)** where “###” is the number of the actual page being monitored (from 100 to 899).

It is possible to change the assignment using the **Edit pages** sub-menu. This menu allows you to configure the page selection for the current input.

### To switch teletext/subtitling off

- Right-click the monitor, point to **Teletext & Subtitling**, and then click **Off**.

## Editing UMD Text

### To edit the text on a UMD

- 1 Right-click the UMD whose text label you wish to modify, and then click **Edit text** on the menu.

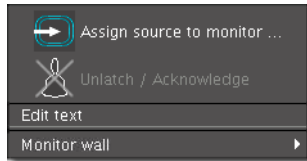

The UMD text area becomes editable.



- 2 Type the new text, and then press ENTER on the Kaleido-RCP2, RCP-200, or external keyboard.

The UMD displays the new text.



## Selecting an Input Method

---

**Note:** In the case of a KMV-3901/3911 multiviewer, the current version of the Kaleido-X software does not support input methods on the monitor wall. As a workaround, you can use XEdit, open the layout that contains the text you wish to modify (e.g. static UMD text, logical source text level), and then use the appropriate input method from your client PC or laptop.

---

### To select an input method

- 1 Click the appropriate composite or video monitor on the monitor wall.
- 2 Press left Alt+Shift+1 on the external keyboard.  
The **Select Input Method** menu appears.
- 3 On the **Select Input Method** menu, click the appropriate input method.



You can now type text in your language of choice, using an external keyboard connected to the Kaleido-RCP2.

## Assigning Sources to Monitors

Any monitor in a layout can be assigned a logical source in XEdit. It is possible to change the logical source assignment directly on the monitor wall.

Note: Logical source assignments can also be changed by configuring actions in XEdit. See [Creating Actions](#) on page 301 for more information.

### Assigning a Logical Source to a Monitor by Using the Kaleido-RCP2

To assign a logical source to a monitor, by using the Kaleido-RCP2's CHANNEL button

- 1 Move the pointer over the monitor that is to be assigned a logical source, and then press CHANNEL on the Kaleido-RCP2.

The **Assign Source** window appears.

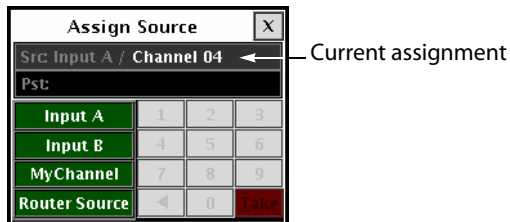

The label of each category/index button in **Assign Source** is based on recurring strings found in the logical source names available for your system. The **Src** box shows the current assignment.

- 2 Click through the categories until the **Pst** box shows the logical source you wish to assign to the selected monitor. For example, if you wish to assign the logical source named "/Input B/Channel 16" to the monitor, click **Input B**, **1**, and then **6**.

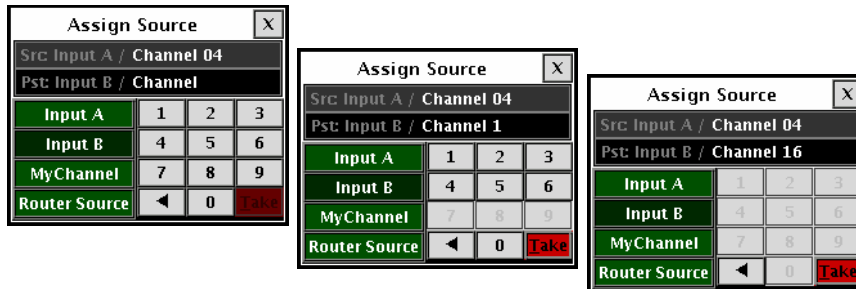

- 3 Click **Take**.

The selected logical source is now assigned to the monitor.

- 4 Click the x button to close the **Assign Source** window.

### Assigning a Logical Source to a Monitor by Using the RCP-200

Although logical source assignments can be accomplished via the CHANNEL monitor wall function (see [page 52](#)), you may find the RCP-200's category/index router view more convenient. To use the RCP-200's category/index panel, your multiviewer system must have been configured to be controlled as a router. In a layout, the RCP-200 can only control monitors that have been assigned a monitor wall destination.

**To assign a logical source to a monitor, by using the RCP-200's Category/Index panel**

- 1 Select the appropriate head from the room view, by rotating the HEAD knob (or by touching the DISPLAY SELECT category, and then touching the desired room display), if needed.
- 2 Touch the monitor whose source assignment you wish to change.  
The monitor's border turns yellow, indicating that this monitor is a monitor wall destination, and the RCP-200's category/index panel appears on the left-hand screen.  
The label of each category/index button is based on recurring strings found in the logical source names available for your system. The **Src** and **Dst** areas show the current source assignment and the monitor wall destination number for the selected monitor.
- 3 Touch through the categories until the **Pst** area shows the logical source you wish to assign to the selected monitor. For example, if you wish to assign the logical source named "/Input B/Channel 16" to the monitor, touch **Input B, 1**, and then **6**.
- 4 Press **Take**.  
The selected logical source is now assigned to the monitor.

**To assign a logical source to a monitor, by using the RCP-200's CHANNEL knob**

- 1 Touch the WALL MOUSE category if it is not already selected, and then move the pointer over the composite or video monitor whose source assignment you wish to change.
- 2 If you have yet to assign the CHANNEL wall function to one of the programmable knobs, rotate the knob you wish to program until CHANNEL is selected, and then press the knob.  
CHANNEL appears above the programmed knob.
- 3 Press the CHANNEL knob.  
The **Assign Source** window appears on the monitor wall.

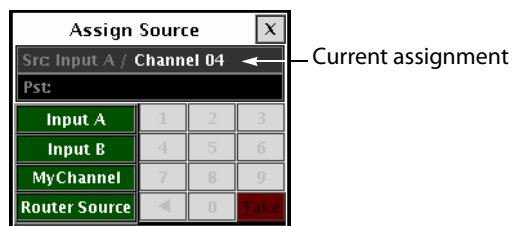

The label of each category/index button in **Assign Source** is based on recurring strings found in the logical source names available for your system. The **Src** box shows the current assignment.

- 4 Click through the categories until the **Pst** box shows the logical source you wish to assign to the selected monitor. For example, if you wish to assign the logical source named "/Input B/Channel 16" to the monitor, click **Input B, 1**, and then **6**.



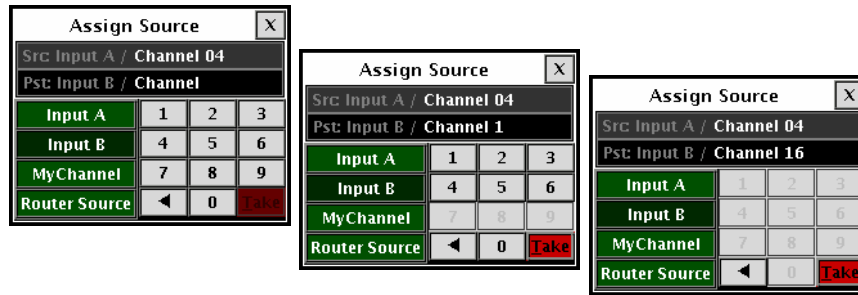

- 5 Click **Take**.  
The selected logical source is now assigned to the monitor.
- 6 Click the **x** button to close the **Assign Source** window.

## Assigning a Logical Source to a Monitor by Using the Mouse

To assign a logical source to a monitor, by using the mouse

- 1 Right-click the monitor that is to be assigned a logical source.
- 2 On the menu, point to **Assign source to [component]** (where [component] will be **monitor, video, UMD, tally, audio meter, status alarm, time code, metadata display, subtitling, or clock**, depending on the monitor you clicked).



The **Assign Source** window appears.

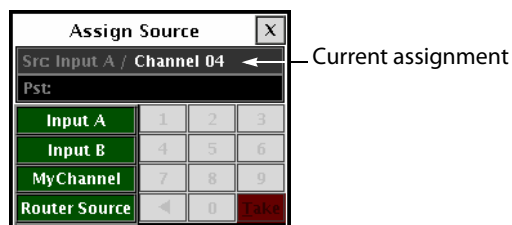

The label of each category/index button in **Assign Source** is based on recurring strings found in the logical source names available for your system. The **Src** box shows the current assignment.

- 3 Click through the categories until the **Pst** box shows the logical source you wish to assign to the selected monitor. For example, if you wish to assign the logical source named **"/Input B/Channel 16"** to the monitor, click **Input B, 1**, and then **6**.

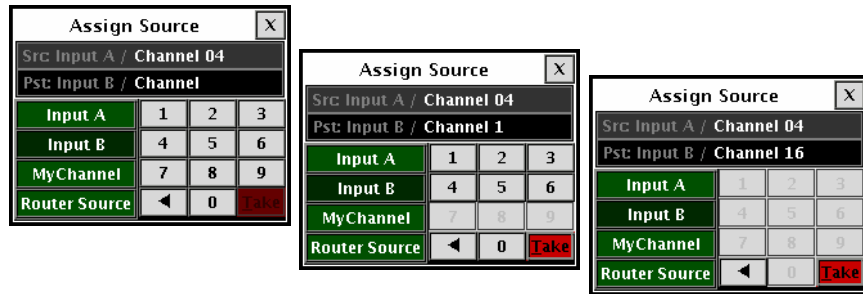

- 4 Click **Take**.  
The selected logical source is now assigned to the monitor.
- 5 Click the x button to close the **Assign Source** window.

## Changing Crosspoints

### Changing Logical Sources Assignments on a Kaleido-X Configured as a Router

#### To change a monitor's source assignment by using a router control device or application

- Apply a crosspoint change to route the desired Kaleido-X logical source to the video monitor whose source assignment you wish to change on the monitor wall, in the same way you would do for any router controlled by the device or application you have.

The video from the first video level assignment within the selected logical source appears in the video window.

When the current layout is reloaded, either of the following two situations may apply.

- **No logical source:** If there was no logical source associated with the monitor, then the Kaleido-X will remember the new source assignment.
- **Not a monitor wall destination:** If the monitor was not already configured as a monitor wall destination, then the layout will be reloaded in its initial state, as it was configured in XEdit.

### Viewing Assignment Information

#### To view the current assignment information for a video monitor

- Right-click the video monitor, and then point to **Info** on the menu.

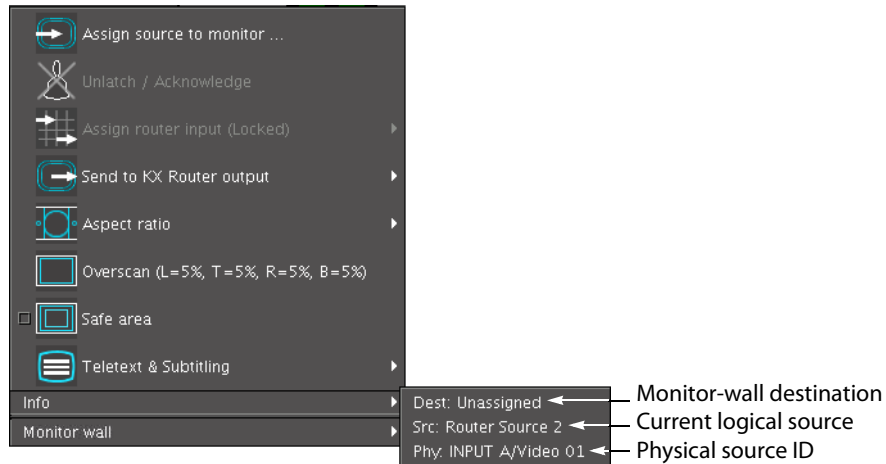

The following information appears, as a submenu:

Dest	Name associated with this monitor when considered as a destination in the context of the <i>KX Router</i> logical router
Src	Name of the logical source currently assigned to this monitor.
Phy	Identifier associated with the physical multiviewer input providing the current signal to this monitor.

### Notes

- In the case of a Kaleido-IP, the physical input information (**Phy**) is not relevant.
- The information shown is not dynamic. To view the latest information, close the menu, and then open it again.
- The physical input information (**Phy**) indicates “Unassigned” when there are no logical source assigned to the monitor, or when the current logical source does not include any video level.
- The physical input information (**Phy**) may indicate “Unresolved” in situations such as the following:
  - the router that provides the current source to the multiviewer is not configured properly;
  - the router interconnections are not configured properly;
  - there is no communication between the router and the multiviewer;
  - an input card was removed (in the case of a Kaleido-X, or Kaleido-MX multiviewer model);
  - there are not enough multiviewer inputs connected to the router to handle all the signals being routed to monitor wall destinations.

## Changing an Internal Router Crosspoint

### Notes

- This feature is only available on Kaleido-X (7RU), Kaleido-X (14RU), and Kaleido-X16 multiviewers, with the *SDI Router Output* option, and whose internal router is properly configured within the first level of the *KX Router* logical router. See [Configuring a Multiviewer's Internal Router](#), on page 364 for more details.
- In the case of a Kaleido-X (14RU) expansion system, to be able to send a video signal to a router output on either frame, the internal routers must be connected by expansion cables, and router expansion must have been properly configured in XEdit. Refer to "Configuring Router Card Expansion" in the Kaleido-X (7RU) Hardware Description & Installation Manual, for more information.

### To change a crosspoint in the internal router

- 1 Right-click the appropriate composite or video monitor on the monitor wall.
- 2 On the menu, point to **Send to [router] output** (where [router] will be the name of the first logical router mapped to your multiviewer's router outputs), navigate to the appropriate logical output, and then select it.

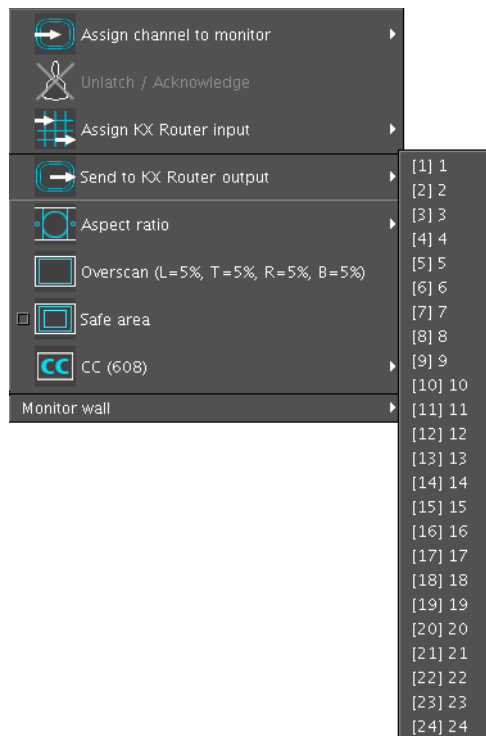

The source signal displayed on the monitor is routed to the selected destination.

## Changing an External Router Crosspoint

### Notes

- As of version 5.20 of the Kaleido-X software, when a multiviewer manages an upstream router, you should manage the router's physical sources as logical sources within the multiviewer system (see [page 177](#)). Router sources can thus be assigned to monitor wall elements transparently, just as sources connected directly to the multiviewer's inputs (see [Assigning Sources to Monitors](#), on page 51).
- In the case of a multiviewer systems configured with an upstream router that has more than 288 sources, the **Assign [router] input** menu mentioned in the procedure below is not available, and you must therefore manage the router's physical sources as logical sources within the multiviewer system.
- The KMV-3901/3911 multiviewers do not support the procedure described below.

### To change an external router crosspoint

- 1 Right-click a composite or video monitor on the monitor wall.
- 2 On the menu point to **Assign [router] input** (where [router] will be the name of a logical router whose outputs are connected to the multiviewer inputs), navigate to the input you wish to assign to the monitor, and then select it.

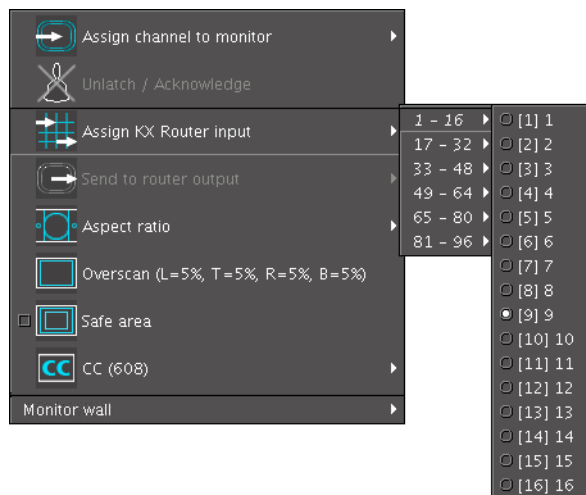

The multiviewer requests the specified source signal from the router.

**Note:** What you see on the wall is not a list of physical inputs, but of logical inputs (labels). Once you have established your configuration in XEdit, you always work with logical devices/levels.

## Using Timers

Timers can be assigned to timer monitors in a layout. Any user can control such timers by using the timer monitor's buttons and menu. An RCP user can be assigned a specific timer.

This allows using the numeric keypad on an external keyboard connected to the Kaleido-RCP2 to control the timer.

### Controlling a Timer by Using the Timer Monitor's Buttons and the Menu

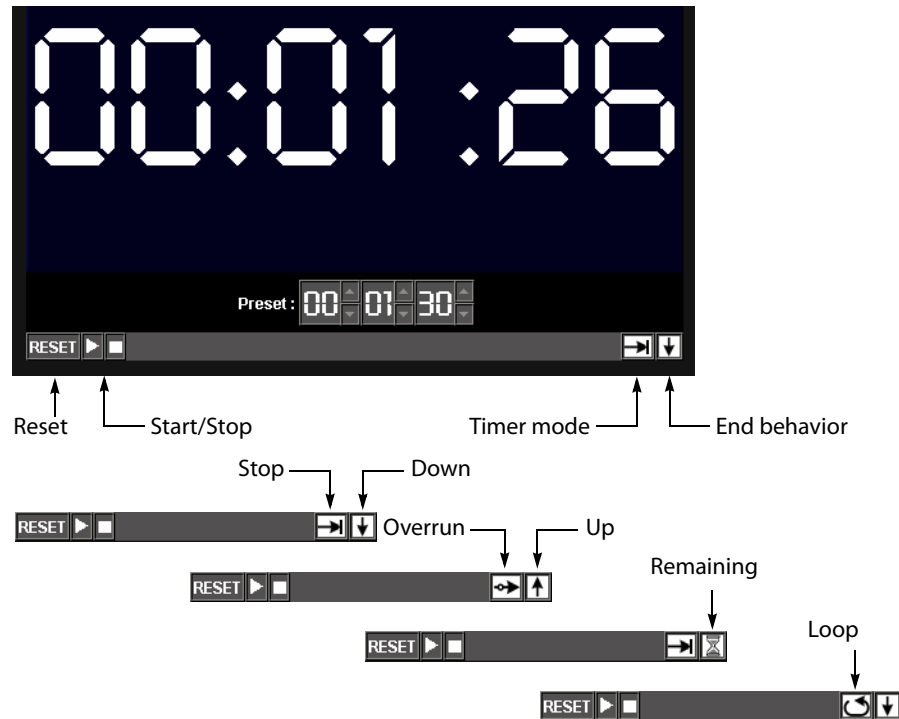

#### Notes

- Timer monitors display time in HH:MM:SS format. Even if the monitor is synchronized with an LTC source, frame count is not displayed.
- Using a timer monitor's **Reset**, **Timer mode** or **End behavior** buttons will stop the timer, if it was running.

### To configure an interactive timer monitor on the monitor wall

- 1 Right-click the timer you wish to configure.

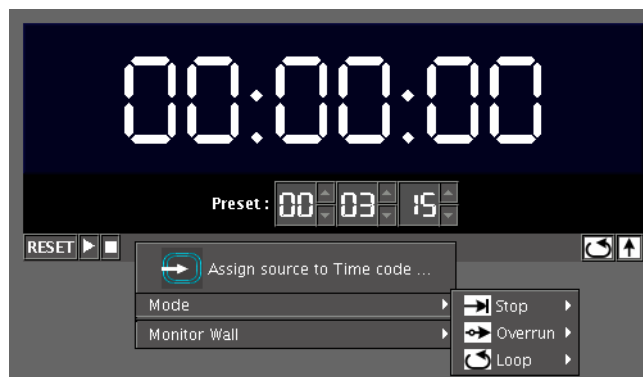

- 2 On the menu, point to **Mode**, navigate to the appropriate timer mode, and then click the desired end behavior.

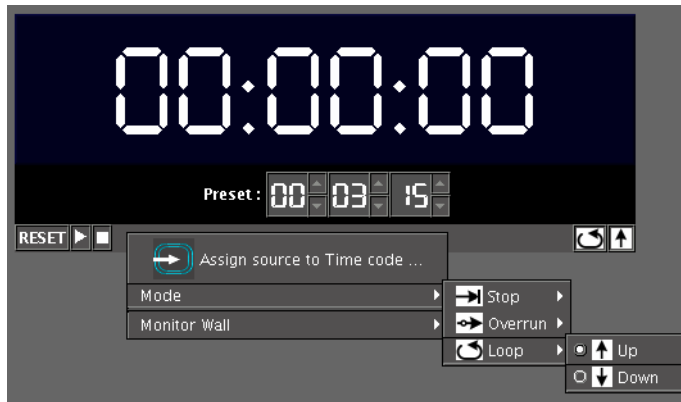

Alternatively, you can set the mode and behavior directly, by clicking the timer monitor's **Timer mode**, and **End behavior** buttons:

- Click the **Timer mode** button to select one of three modes: **Overrun**, **Stop** or **Loop**.
- Click the **End behavior** button to select one of three modes: **Down**, **Up** or **Remaining**.

The timer monitor is updated accordingly.

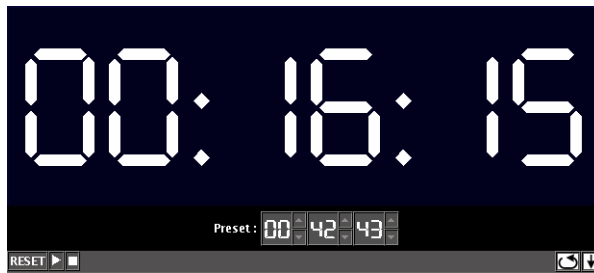

3 Use the **Preset** controls to set a new preset time.



4 Click the **Reset** button to reset the timer to its initial value (based on timer mode and preset time).

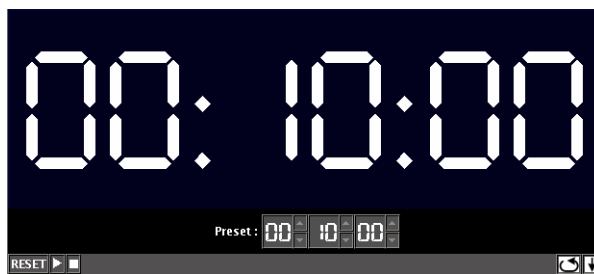

5 Click the **Start** button to start the timer.



### Controlling a Timer by Using an External Numeric Keypad

If a timer is assigned to the current RCP user, or else if a timer is assigned by default for the room, then the external keyboard's numeric keypad controls this specific timer.

---

**Note:** The reserved keys are always enabled, whether Num Lock is set or not.

---

#### To configure your assigned timer, by using a numeric keypad

- Press the slash key ("/") to set the timer mode and end behavior. Keep pressing the key to cycle through all the available options, until the buttons show the appropriate settings.
- Press the plus key ("+") to reset the timer. (This will also stop the timer if it was running.)
- Press the Enter key to start/pause the timer.
- Use the number keys to set or modify the preset time.

## Triggering Actions

---

### Notes

- An Action's trigger is determined when the Action is created in XEdit. See [Creating Actions](#) on page 301 for more information.
  - To create background actions that can be triggered from the RCP-200's programmable knobs, refer to [Creating an Action that can be Triggered via a Gateway Command](#), on page 307.
- 

### Triggering an Action from the RCP-200

#### To trigger a background action from the RCP-200's programmable knobs

- 1 If you have yet to assign the action you wish to trigger to one of the programmable knobs, rotate the knob you wish to program until the action is selected, and then press the knob.  
The action's name appears above the programmed knob.
- 2 Press the knob to trigger the action.

### Triggering an Action from the Monitor Wall

#### To trigger a monitor wall action

- 1 Move the pointer over a monitor associated with the action you wish to trigger.



- The pointer changes to a hand icon.
- 2 If the action is not triggered automatically, click or double-click the monitor.

## Triggering GPI Output Events

---

**Note:** This topic does not apply to the Kaleido-IP.

---

### To trigger a GPI output event

- 1 In XEdit, configure the appropriate GPI line's direction as an output (system calibration).
- 2 Create an action to toggle the GPI output on/off state, and assign it to a monitor.
- 3 Export the database to the multiviewer.
- 4 Trigger the action by clicking the monitor.  
The GPI line's state changes.

---

**Note:** GPI lines configured as outputs can have their state set manually for test purposes in XEdit's **System** tab:

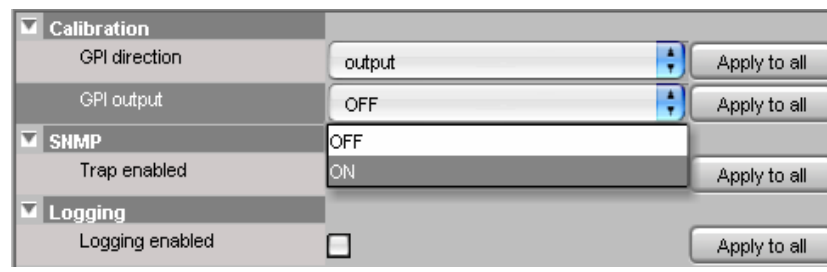

## Acknowledging Alarms

### Acknowledging Alarms on the Monitor Wall

#### To acknowledge an alarm, by using the Kaleido-RCP2

- Move the pointer over the monitor whose alarm state you wish to acknowledge, and then press the UNLATCH STATUS button on the Kaleido-RCP2.

#### To acknowledge an alarm, by using the RCP-200

- 1 Touch the WALL MOUSE category if it is not already selected, and then move the pointer over the monitor whose alarm state you wish to acknowledge on the monitor wall.
- 2 If you have yet to assign the UNLATCH STAT wall function to one of the programmable knobs, rotate the knob you wish to program until UNLATCH STAT is selected, and then press the knob.  
UNLATCH STAT appears above the programmed knob.
- 3 Press the UNLATCH STAT knob.

#### To acknowledge an alarm, by using the mouse

- Right-click the monitor whose alarm state you wish to acknowledge, and then click **Unlatch/Acknowledge** on the menu.

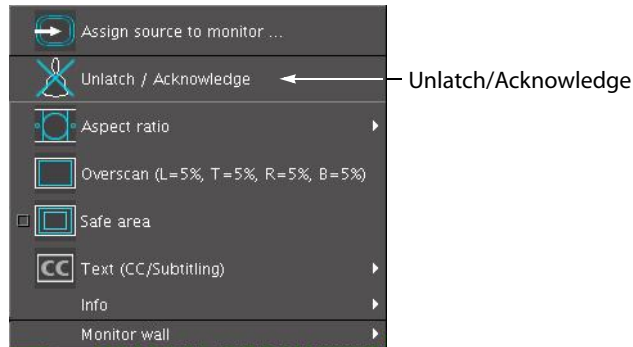

### To acknowledge all current alarms in a room

- Right-click the monitor wall, point to **Monitor wall** (if you clicked a monitor), and then click **Unlatch/Acknowledge all** on the menu.

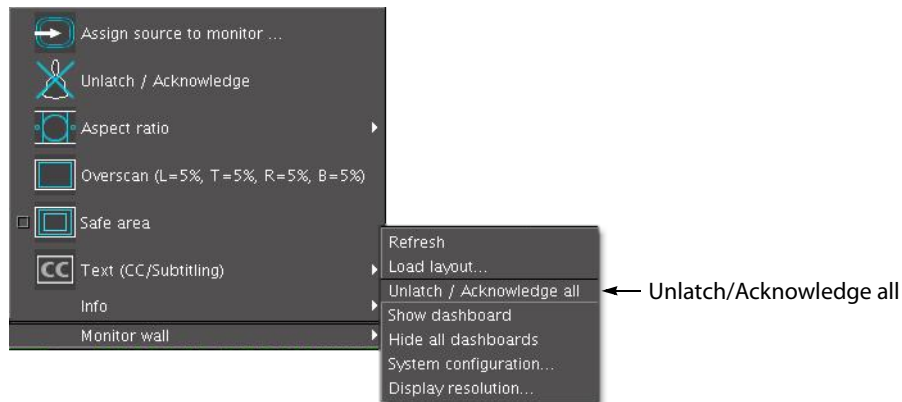

This will acknowledge every alarm monitored *in the current room*.

### Acknowledging Alarms by Using an Action

#### To acknowledge alarms, by using an action

- Create a *Unlatch/Acknowledge all* action. This action can be assigned to a monitor on the monitor wall, it can be triggered by loading or unloading a layout, or it can be a background action. See [Creating Actions](#) on page 301 for details.

## Triggering Audio Monitoring

---

**Note:** Before connecting a display or AV receiver to a Kaleido-IP multiviewer, make sure the multiviewer is powered off. In the advent that you have connected such a device while the multiviewer was running, you must restart the multiviewer for audio monitoring to be functional. See [Restarting and Shutting Down a Kaleido-IP Multiviewer](#) on page 503.

---

## Triggering Audio Monitoring by Using the mouse, the RCP-200, or the Kaleido-RCP2

Note: If you have yet to assign the AUDIO MONITOR wall function to one of the RCP-200's programmable knobs, rotate the knob you wish to program until AUDIO MONITOR is selected, and then press the knob. AUDIO MONITOR appears above the programmed knob.

### To trigger audio monitoring, by using the mouse, the RCP-200, or the Kaleido-RCP2

- Move the pointer over an audio monitor, and then
  - click the monitor
  - press AUDIO MONITORING on the Kaleido-RCP2
  - press the AUDIO MONITOR programmable knob on the RCP-200

This will route *the monitor's audio source* to the monitoring output assigned to the current RCP user.

- Move the pointer over a video monitor, and then
  - click the monitor
  - press AUDIO MONITORING on the Kaleido-RCP2
  - press the AUDIO MONITOR programmable knob on the RCP-200

This will route *the specific audio level associated with the video monitor*, based on the assigned logical source.

- Move the pointer over any other monitor, and then
  - click the monitor
  - press AUDIO MONITORING on the Kaleido-RCP2
  - press the AUDIO MONITOR programmable knob on the RCP-200

This will route *the first audio level of the associated logical source* to the monitoring output.

Audio monitors that have an audio monitoring indicator (see [Configuring Audio Monitors](#), on page 252) and that are currently assigned the same audio level, will turn the color associated with the current display (see [Calibrating the Audio Monitoring Color](#), on page 130), showing that someone is listening at this specific display.

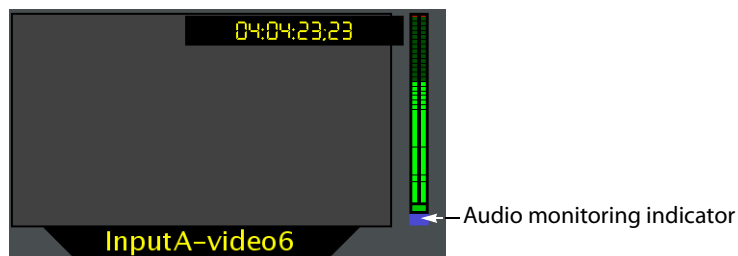

If multiple users are listening to the same audio source at the same time, then the indicator will show one color only: (1) the color associated with a display in the same room (2) the color associated with the display at the monitoring output that was enabled last in the room.

## Controlling the Volume at the Analog Audio Monitoring Output

### Controlling the volume from the Kaleido-RCP2

#### To control the volume at the analog audio monitoring output, from the Kaleido-RCP2

- Adjust the audio volume for your assigned monitoring output by using the up and down volume buttons on the Kaleido-RCP2.
- Mute the audio by pressing the Mute button on the Kaleido-RCP2.
- Attenuate the volume by 20 dB by pressing the -20 dB button on the Kaleido-RCP2.

### Controlling the volume from the RCP-200

On the RCP-200, pressing the VOL knob repeatedly alternates between the normal, mute, and -20 dB audio output mode.

#### To control the volume at the analog audio monitoring output, from the RCP-200

- Adjust the audio volume for your assigned monitoring output by rotating the VOL knob.
- Mute the audio by pressing the VOL knob until MUTE appears above the knob.
- Attenuate the volume by 20 dB by pressing the VOL knob until -20 dB appears above the knob.

## Triggering Audio Monitoring by Using an Action

---

Note: All audio and video monitors are configured by default, with a *Monitor audio* action triggered by a single click.

---

#### To trigger audio monitoring, by using an action

- Create a *Monitor audio* action, for the audio source you wish to monitor. This action can be assigned to a monitor on the monitor wall, or it can be a background action. See [Creating Actions](#) on page 301 for details.

## Setting a Display Monitor's Output Resolution

---

Note: This section does not apply to the KMV-3901/3911, Kaleido-XQUAD, Kaleido-MX, and Kaleido-Modular-X, which do not support setting a display output resolution from the monitor wall. For these multiviewers, you can set your displays' output resolution by using XEdit, the Densité controller's local control panel (or a control panel in iControl, if available). See [Configuring Displays](#) on page 202, or refer to the Quick Start Guide for your multiviewer, for details.

---

With a Kaleido-IP, Kaleido-X, or Kaleido-X16, you can set a display's output resolution from the monitor wall. This is useful if you don't have access to another computer. If there is no output on a display, you can reset the output resolution to 1280 × 1024 @ 60 Hz, by using a keyboard shortcut: hold down the Ctrl and Alt keys, and then press R.

- In the case of a **Kaleido-X**, connect the keyboard to a USB port on the output card associated with the display. If two displays are connected to this output card, then the

resolution is applied to both. Alternatively, use a keyboard connected to the Kaleido-RCP2.

- In the case of a Kaleido-X16, connect the keyboard to one of the USB ports on the multiviewer. If two displays are connected to the multiviewer, then the resolution is applied to both. Alternatively, use a keyboard connected to the Kaleido-RCP2 (if available).

---

**Note:** If the keyboard is connected to a Kaleido-RCP2, the **Keyboard** attribute for the current RCP user must have been set to "US" in XEdit, otherwise the shortcut may not work (i.e. it could be parsed and converted to a special character, depending on the selected locale). In the case of a Kaleido-X, the shortcut will reset the resolution on the active display (the one where the mouse pointer is located) and on the other display connected to the same output card, if any.

---

## Specifying a Display Output Resolution from the Monitor Wall

### To set your display output resolution from the Monitor Wall

- 1 Right click the monitor wall background, and then click **Display Resolution** on the menu.

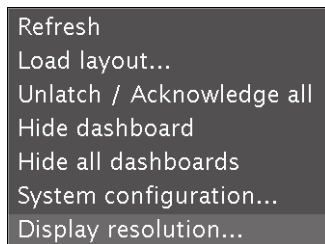

- 2 Choose a value from the **Default DVI resolution** list.

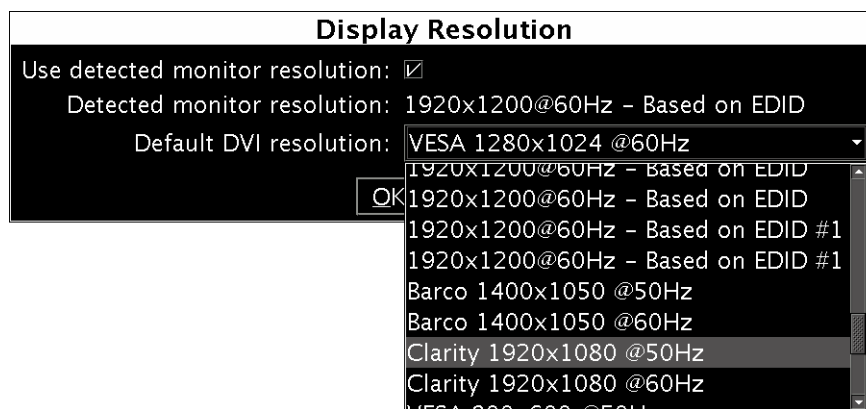

- 3 Click **OK**.

## Enabling EDID Auto-Detection from the Monitor Wall

### Notes

- The Kaleido-IP multiviewers do not yet support automatic output resolution detection.

---

Notes (continued)

- The monitor EDID auto-detection feature is enabled by default in order to facilitate the initial setup of a Kaleido-X system. Setting an output head to a specific resolution, from a multiviewer service panel in iControl (if available), from the monitor wall (Kaleido-IP, Kaleido-X, Kaleido-X16), or from a Densité controller's local control panel (Kaleido-MX, Kaleido-Modular-X, KMV-3901/3911, Kaleido-XQUAD) disables the EDID auto-detection for this head.
- 

**To enable EDID auto-detect for a display**

- 1 Right-click the monitor wall background, and then click **Display Resolution** on the menu.

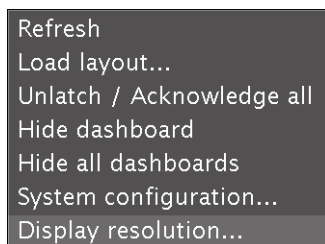

- 2 Select the **Use detected monitor resolution** check box.

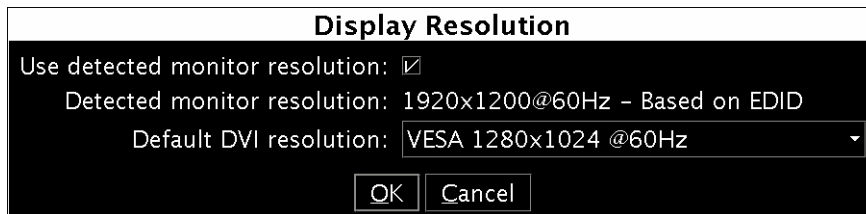

- 3 Click **OK**.

## Changing the IP Address of a Multiviewer from the Monitor Wall

---

Notes

This section *does not* apply to the KMV-3901/3911, Kaleido-XQUAD, Kaleido-MX, and Kaleido-Modular-X. For these multiviewers, you can configure the network settings by using XAdmin, the Densité controller's local control panel (or a control panel in iControl, if available). See [Configuring a Multiviewer's IP Settings](#) on page 456, or refer to the Quick Start Guide for your multiviewer, for details.

In the case of a Kaleido-IP, changing the multiviewer's network settings from the monitor wall is not yet supported.

---

With a Kaleido-X, or Kaleido-X16, you can set the IP address, system name, and other parameters via a control panel on the monitor wall.

### To change the IP address of the multiviewer from the monitor wall

- 1 Right-click anywhere on the monitor wall, point to **Monitor wall**, and then click **System configuration**.

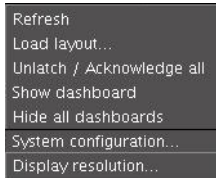

The **System Configuration** window appears.

- 2 Click the **Ethernet** tab.
- 3 Type the required Frame IP address, network mask, and gateway address in the appropriate boxes.
- 4 Type the required addresses for all outputs.
- 5 Click **OK**.
- 6 When prompted to restart the system to apply your changes, click **Yes**.  
The new configuration will become effective once the system restart has completed.





# 4 Managing Kaleido-X Systems

This section explains what constitutes a Kaleido-X system, and the related workflow.

## Key Concepts

Term	Description
System	A <i>Kaleido-X</i> system represents a grouping of equipment, including one or more multiviewers that have the <i>Kaleido-X</i> software, and a number of peripheral devices such as routers, production switchers, UMD controllers, or automation systems. In XEdit, you work against one system at a time. Each system is stored as a separate database.
Kaleido-X	The Kaleido-X multiviewer is a multi-room, multi-image processor and router in a single, expandable frame. The compact Kaleido-X (4RU) multiviewer supports 32 inputs and 4 multi-image outputs. The Kaleido-X (7RU) multiviewer can display 96 inputs over up to 8 displays of any resolution and orientation. The Kaleido-X (7RU) built-in routing capability offers switching of 96 unprocessed inputs to 48 HD/SD outputs for feeding monitors, test equipment, master control or production switchers, ISO recorders, or other multi-image processors.
Expansion system	By using a mid-plane expansion module, two <i>Kaleido-X</i> (7RU) frames can be connected to display up to 192 video inputs over up to 12 displays. In XEdit, an expansion system is identified as <i>Kaleido-X</i> (14RU).
Kaleido-MX	The Kaleido-MX standalone multiviewer system is ideal for production control rooms, trucks and outside broadcast operations. Available in two form factors (1 RU, and 3 RU), the Kaleido-MX supports up to 64 video inputs, and up to four multiviewer outputs.
Kaleido-Modular-X	The Kaleido-Modular-X offers a flexible and scalable multiviewer solution for TV production optimized for the space, power and weight considerations found in studios and outside broadcast trucks. FlexBridge coax cable bridging between the input and output modules allows for the installation of the input stage next to the router or sources, and the output stage next to displays, for simpler, cost-effective cabling with none of the risk associated with HDMI extenders. The Kaleido-Modular-X supports up to 64 video inputs, and up to four multiviewer outputs. In XEdit and XAdmin, a Kaleido-Modular-X system is identified as <i>Kaleido-MX</i> .
Kaleido-X16	The Kaleido-X16 is a compact, ultra-quiet multiviewer in a 1RU frame, with 16 inputs and two outputs. It provides a subset of the features of the Kaleido-X 4RU and 7RU models. There are two types of Kaleido-X16: Kaleido-X16-S (single head) and Kaleido-X16-D (dual head).

Term	Description
KMV-3901/3911	<p>The KMV-3901, the first member of the Kaleido-Modular series, is a multiviewer on a single Densité card, with eight inputs and two outputs. Designed to address production-type applications, it supports a subset of the features offered by the other Kaleido-X series multiviewer models:</p> <ul style="list-style-type: none"> <li>• Processing: Video scaling, Video cropping, 3Gbps (level A only) support, KXI-DVI-Bridge support.</li> <li>• Probing: Display of audio levels (up to 16 audio signals per head), time codes (based on URS signal from a REF-1801 Densité card, or on embedded reference signal), video format and audio format.</li> <li>• GPIO interface: Support for 8 GPI inputs and 2 GPI outputs.</li> </ul> <p>In addition to the features listed above, the KMV-3911 multiviewer supports up to two HD-SDI monitoring outputs. In XEdit, all KMV-3901/3911 models, with any number of inputs and outputs are identified as <i>Kaleido-Modular</i>. In XAdmin they are identified as <i>Kaleido-Modular KMV-3911</i>, or <i>Kaleido-Modular KMV-3901</i>.</p>
Kaleido-IP	<p>The Kaleido-IP can monitor and display HD and SD television programs distributed over IP, across two HDTV displays. It supports MPEG-2 and H.264/AVC compressed video, and the AAC, AC-3, DD+, MPEG-1, MPEG-2, MPEG-4 AAC LC, and MPEG-4 HE-AAC compressed audio formats, within unencrypted DCII, DVB, or ATSC streams. The Kaleido-IP X310 supports concurrent decoding of up to 64 MPEG-2 or up to 32 H.264 HD video programs. In the case of SD signals, they support concurrent decoding of up to 128 MPEG-2 or up to 64 H.264 programs. The Kaleido-IP X110 supports concurrent decoding of up to 16 MPEG-2 or up to 12 H.264 HD programs, and up to 48 MPEG-2 or up to 24 H.264 SD programs. The Kaleido-IP X300 supports concurrent decoding of up to 24 MPEG-2 or up to 16 H.264 HD programs, and up to 64 MPEG-2 or up to 32 H.264 SD programs. The Kaleido-IP X100 supports concurrent decoding of up to 8 MPEG-2 or up to 6 H.264 HD programs, and up to 24 MPEG-2 or up to 12 H.264 SD programs. In XAdmin and XEdit, a Kaleido-IP X100 or Kaleido-IP X300 with two network adapters is identified as <i>Kaleido-IP-2</i>. A Kaleido-IP X110, Kaleido-IP X310, or Kaleido-IP X300 with four network adapters is identified as <i>Kaleido-IP-4</i>, and a Kaleido-IP X310, or Kaleido-IP X300 with six network adapters is identified as <i>Kaleido-IP-6</i>.</p>
Kaleido-XQUAD	<p>The Kaleido-XQUAD is a standalone quad-split multiviewer that is ideal for truck and studio monitoring. It is available in two versions: the Kaleido-XQUAD features four 3Gbps/HD inputs and a single multiviewer output (HDMI/HD-SDI), and the Kaleido-XQUAD-DUAL offers eight 3Gbps/HD inputs and two multiviewer outputs. Both versions offer exceptional display flexibility and outstanding space and energy efficiency, using a 1RU half width frame with silent ventilation for installation within studios. The multiviewer can be used for small installations with one or two displays, and in much larger configurations using multiple Kaleido-XQUADs. In XEdit, the Kaleido-XQUAD and Kaleido-XQUAD-DUAL are identified as <i>Kaleido-Modular</i>. In XAdmin they are identified as <i>Kaleido-Modular KMV-3911</i>.</p>

Term	Description
XEdit	XEdit is the Kaleido-X layout editor, a software intended to be run on a remote computer. Its purpose is to define your Kaleido-X system components, including external devices, create rooms, logical sources, layouts, and RCP user definitions, and perform all the configurations required for successful operation of the multiviewer. XEdit has two modes of operation: you can work <i>offline</i> in a local workspace and then apply your changes by exporting them to the multiviewer, or you can connect to a multiviewer and work in online mode, directly on the system. Changes made in online mode take effect immediately on the monitor wall.
Database	Layouts and related configurations for your Kaleido-X system are created in XEdit. All this information is stored in a database. When you work in offline mode, you load the appropriate database in a local workspace on the PC where XEdit is used. XEdit can export such a database to a multiviewer, or import the current layouts and configurations from a multiviewer into the local workspace on your PC. For changes you make in offline mode to take effect on the monitor wall, you must export the database to a multiviewer. Conversely, any configuration change you make in online mode must be imported from the multiviewer into your local workspace if you wish to be able to make further changes in offline mode.
Cluster	A cluster refers to multiple multiviewers, configured so that they can be operated as a single system from a room comprising up to 48 displays fed by the different multiviewers' outputs. The complete cluster system can include up to 128 displays. See <a href="#">Creating a Cluster</a> on page 88.
Cascade	A cascade refers to up to three <i>Kaleido-X16</i> or up to three <i>KMV-3901/3911</i> multiviewers, configured so that they can be operated as a single system from a room. The cascade makes it possible to monitor up to 48 video inputs—in the case of a <i>Kaleido-X16</i> cascade—, or up to 24 video inputs—in the case of a <i>KMV-3901/3911</i> cascade—, on a single monitor wall display. Depending on your purposes, you may wish to monitor both baseband and IP sources at once, on the same monitor wall display. This can be achieved by configuring a hybrid cascade system, involving one <i>Kaleido-IP</i> multiviewer and one <i>Kaleido-X</i> or <i>Kaleido-X16</i> multiviewer. Refer to the Cascade Step-by-Step Configuration guide for your multiviewer model, for more information.
Logical source	A <i>logical source</i> (called a <i>channel</i> , in earlier versions of the software and documentation) refers to a group of physical audio, video, or metadata sources, and text attributes. A logical source can be used as a whole, and assigned to a virtual monitor. See <a href="#">Logical Sources</a> on page 177, for details.

Term	Description
Cards	Cards are added to, and removed from a Kaleido-X, Kaleido-MX, or Kaleido-Modular-X multiviewer (see <a href="#">Managing Cards in a Kaleido-X, or Kaleido-MX System Representation</a> , on page 109). There are different, specialized types of cards: input cards, output cards, a GPI/genlock card, expansion cards and internal router cards. Refer to the appropriate <i>Hardware Description &amp; Installation Manual</i> available on the DVD that shipped with your system, and from Grass Valley's support portal, for more information.
Virtual card slots	<p>The Kaleido-X16 introduced the concept of <i>virtual card slots</i> that represent a set of hardware features directly on the multiviewer's main board. In XEdit, the Kaleido-X16 virtual card slots contain representations of GPI/genlock, input, output, and internal router cards that are equivalent to their physical counterparts on the Kaleido-X (4RU) and Kaleido-X (7RU) models. Likewise, the KMV-3901/3911 multiviewers have virtual card slots with representations of GPI/genlock, input, and output cards.</p> <p>There are, however, some differences in the Kaleido-X16 and KMV-3901/3911 multiviewer models are presented in XEdit, compared to the Kaleido-X models:</p> <ul style="list-style-type: none"> <li>• Cards in virtual slots are always present by default, and cannot be removed in XEdit.</li> <li>• There are no status icons next to a virtual card slot (e.g. inserted or empty card slot icon).</li> </ul> <p>In XAdmin the virtual slot/card concept is represented as follows:</p> <ul style="list-style-type: none"> <li>• Cards in virtual slots have no name.</li> <li>• There is no reset button associated with each card. Instead, there is a single multiviewer reset button that sends a reboot command to the multiviewer.</li> <li>• Cards in virtual slots have no serial number. Instead, there is one serial number for the multiviewer.</li> <li>• Cards in virtual slots do not have individual IP addresses. There is only one IP address, which is associated with the multiviewer.</li> </ul>
Calibration	Calibration refers to the configuration of different card attributes. For example, an output card's <i>Brightness</i> and <i>Contrast</i> attributes can be calibrated, or an input card's <i>Silence threshold</i> attribute. See <a href="#">Calibrating the Kaleido-X</a> on page 119, for details.
Peripheral devices	A peripheral device is an external piece of equipment, such as a router or production switcher, that can be connected to the multiviewer.

## Detailed Directions

Creating and maintaining a Kaleido-X system involves a number of file management tasks, including backup and restore operations. The XEdit software is used to perform these tasks. Some tasks are done online, others in offline mode. Most are available in both modes.

A local database is used as a workspace to save layouts and related configuration data temporarily while you are building your Kaleido-X system in offline mode. If you need to

build more than one system, you can keep working with the same database, and use the backup tool to save the data for each system separately. To further work on a specific system you would then use the restore backup tool. See [Managing Multiple Databases Efficiently](#) on page 116 for an overview of the recommended workflow.

## Opening the XEdit Software

When using XEdit offline, you work inside a workspace located on your client PC. When you first open XEdit, a window will prompt you for the location for this workspace. It is recommended to consider this workspace as a sandbox into which you will always first import the database you wish to work on during the current session, and from which you will export the database at the end of the session.

### To open XEdit

- 1 Double-click the XEdit icon on your desktop: .

**Note:** If you have installed multiple versions of XEdit, the launcher icon on your desktop opens the last version you installed. To open a specific version of XEdit, use the launcher icon on the Start menu (under **All Programs**).

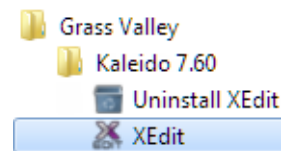

A startup screen appears, followed by the **Database Location** window.



- 2 When prompted to specify the database location, click **Browse**.

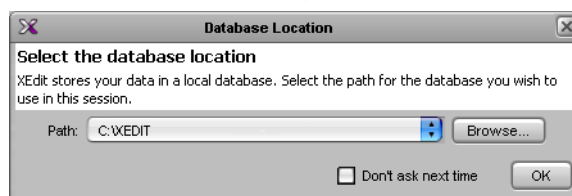

- 3 From the window that opens, locate an appropriate directory for your workspace, and then click **Open** to close the **Select the database location** window.

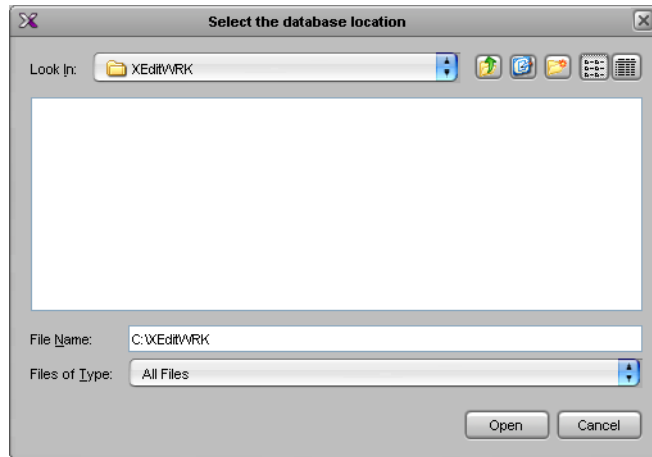

If it is not the first time you open XEdit, and you are satisfied with the location of your local workspace, then select the **Don't ask next time** check box, to avoid being prompted every time you open XEdit.

- 4 Click **OK** to close the **Database Location** window.

XEdit's main application window appears. This may take a few seconds.

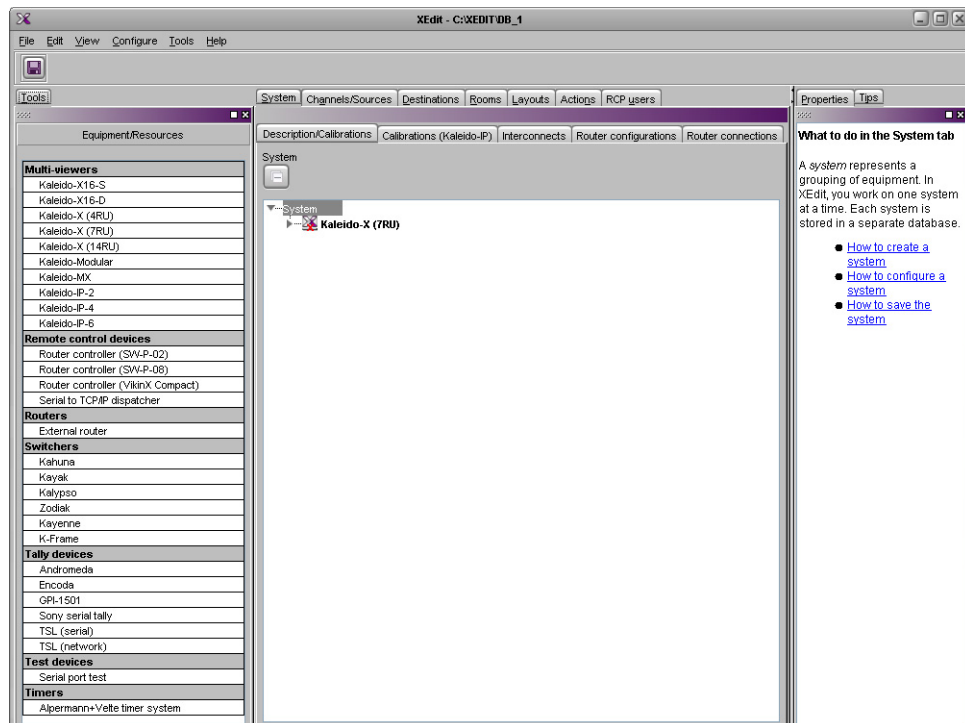

When first opening XEdit in offline mode, the database contains the default configuration for a Kaleido-X (7RU) system, including a fully-populated frame (all cards present) and a set of predefined logical sources.

### To customize the layout of the XEdit application window

- Resize the window, and its three panes, by dragging the window's borders, corners, and pane splitters.
- Move the **Tips**, **Tools**, and **Properties** panes between the left and right panes, and reorder them, by clicking their handle and dragging to the desired location.
- Close the **Tips**, **Tools**, and **Properties** panes by clicking their x button.
- Undock the **Tips**, **Tools**, and **Properties** panes from the main window, by clicking their square button.

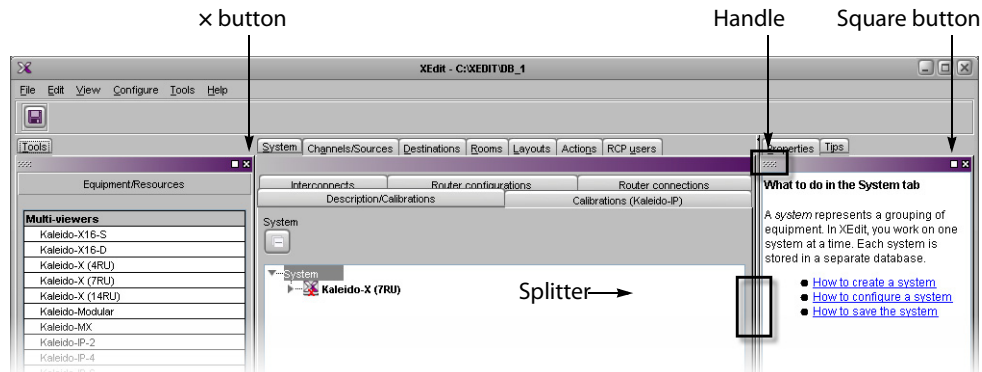

### To restore the default application layout

- 1 Dock the **Tips**, **Tools**, and **Properties** panes, if they are undocked, by clicking their x button.
- 2 On the **View** menu, point to **Panes and tabs**, and then click **Restore default window settings**.

### To close XEdit

- On the **File** menu, click **Exit**. Alternatively, click the x button in the upper right corner of the main application window.

## Using XEdit Online

When using XEdit in *online* mode, any changes made are applied and stored directly on the multiviewer. When using XEdit in *offline* mode, all changes are stored locally on your PC or laptop, and the database must be exported to the multiviewer for the changes to take effect.

When connected to a multiviewer, any change you make to your system's configuration takes effect immediately *on the multiviewer* itself; your local database is not involved. The online mode is not limited to basic system configuration; changes can also be made to existing logical sources, rooms, layouts, RCP users, etc.

---

**Note:** In the case of a Kaleido-IP, you must work in online mode, at least once, to obtain the list of programs and elementary streams under each transport stream.

---

## Connecting to a Multiviewer

To connect to a multiviewer

- 1 On the **Configure** menu, click **Connect**.

The **Connect to Multiviewer** window appears.

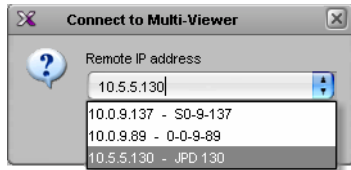

IP addresses for all the multiviewers that are on the same subnet as your PC are included in the list.

- 2 If your PC and the multiviewer are on the same subnet, then you can select the IP address of the multiviewer you wish to connect to from the list. Otherwise type the appropriate IP address in the box.
- 3 Click **OK**.
- 4 If access control is enabled for this multiviewer, then XEdit prompts you for a password. Type the password associated with the RCP user "Admin", and then click **Log on**.



The selected system's hierarchical list appears in XEdit's main pane, showing the multiviewer model, system name and IP address, and the status bar shows the connection status.

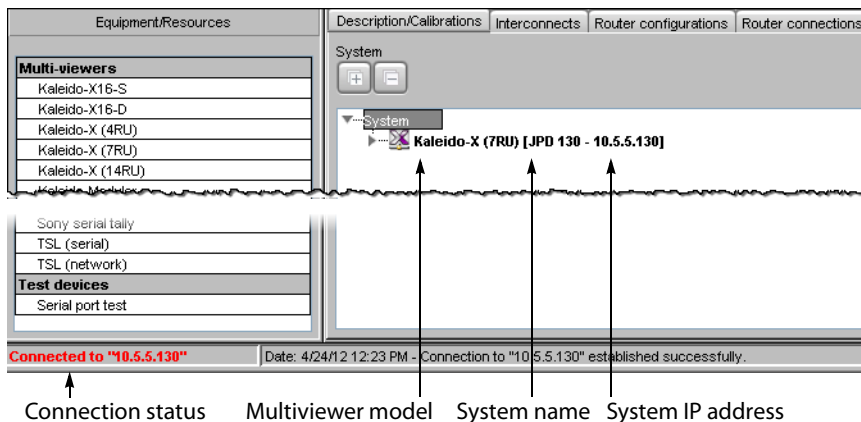

It is also possible to verify which version of the Kaleido-X software is installed on this multiviewer, by moving to pointer to the system name in the System list. A tip appears, showing this information.

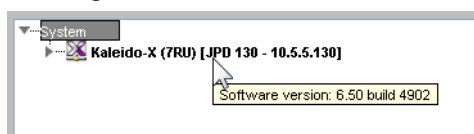



In the case of a cluster system, cluster members are listed in alphabetical order based on the system name, which appears first, and the multiviewer you are currently connected to is highlighted.

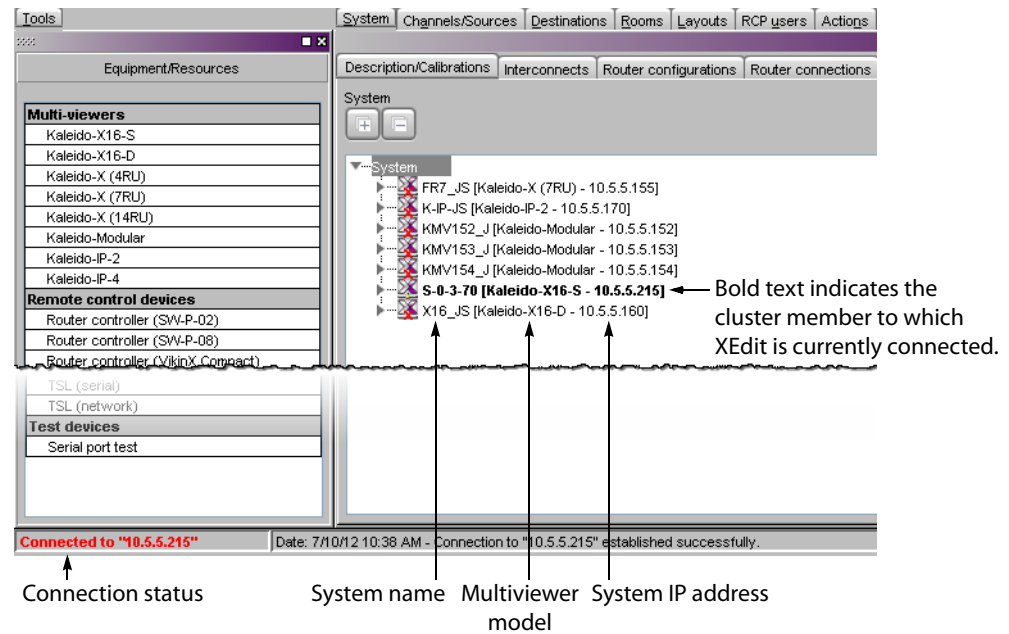

## Notes

- When using XEdit in online mode, some database functions, such as **Export**, **Import**, and **Restore backup**, are not available. Any changes made by the user are not kept locally on the user's PC, but applied directly on the multiviewer. To retrieve the data set from the multiviewer, either disconnect from the multiviewer, and then use the **Import** function, or use the **Create backup** function to save a copy of the database. A database can be restored from a backup repository to your local workspace later. See [Managing Multiple Databases Efficiently](#) on page 116 for a description of the recommended workflow.
- It is not recommended to have two or more users simultaneously connected online to the same multiviewer system for editing.

## Disconnecting from a Multiviewer

### To disconnect from a multiviewer

- On the **Configure** menu, click **Disconnect**.

XEdit switches to its local workspace, and displays the **OFFLINE** status on the status bar.



## Enabling Access Control in XEdit

XEdit supports a simple authentication mechanism to prevent unauthorized users from connecting or exporting to a multiviewer. When access control is enabled, the password associated with the RCP user *Admin* (see [Changing an RCP User's Name and Password](#), on page 321) is enforced.

### To enable access control in XEdit

- 1 Connect to the multiviewer you wish to protect (see [Connecting to a Multiviewer](#), on page 76).
- 2 On the **Configure** menu, click **Access control**.

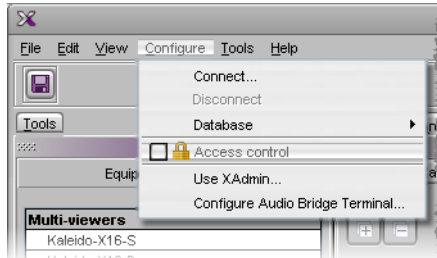

XEdit prompts you for a password.

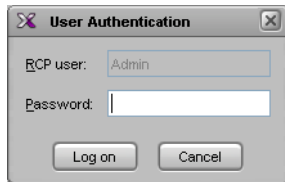

- 3 Type the password associated with the RCP user *Admin*, and then click **Log on**.  
Access control is now enabled for this multiviewer.

### Disabling Access Control in XEdit

#### To disable access control in XEdit

- 1 Connect to the multiviewer you wish to unprotect (see [Connecting to a Multiviewer](#), on page 76).

XEdit prompts you for a password.

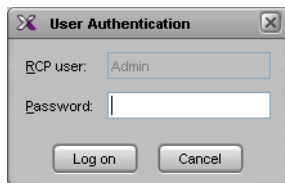

- 2 Type the password associated with the RCP user *Admin*, and then click **Log on**.
- 3 On the **Configure** menu, click **Access control**.

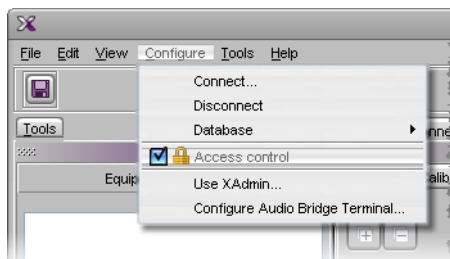

Access control is now disabled for this multiviewer.

## Importing a Database

### To import a database

- 1 On the **Configure** menu, point to **Database**, and then click **Import**.

A window appears, prompting you for the IP address of the multiviewer whose database you wish to import.

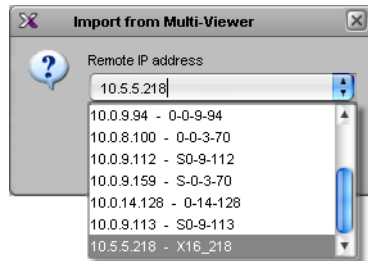

IP addresses for all the multiviewers that are on the same subnet as your PC are included in the list.

- If your PC and the multiviewer are on the same subnet, then you can select the IP address of the multiviewer from the list.
- Otherwise type the appropriate IP address in the box.

- 2 Click **OK**.

A window appears, prompting you to confirm that you really want to import data from the multiviewer.

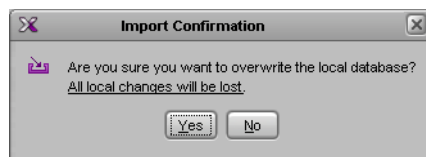

- 3 Click **Yes**.

A progress window appears, followed by a message stating whether the import succeeded or not.

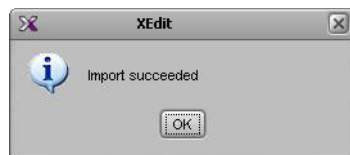
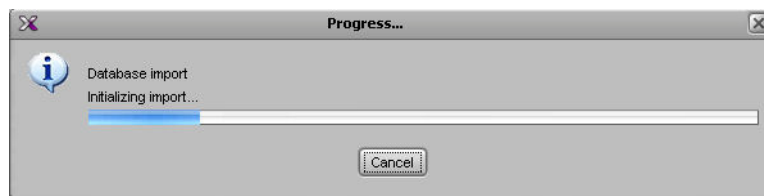

- 4 Click **OK**.

The imported data has replaced the former content in your local workspace. The originating system's multiviewer model and IP address now appear in the System list.

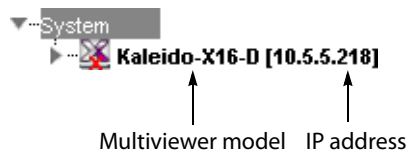

In the case of a cluster system, the System list shows cluster members in alphabetical order based on their system name, which appears first and is followed by the multiviewer model and IP address.

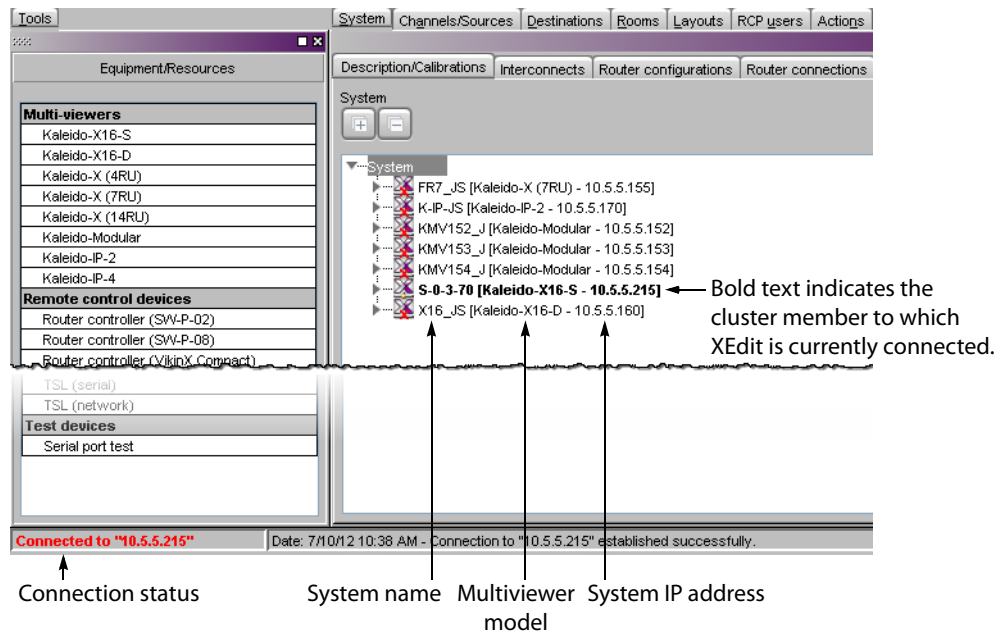

## Exporting a Database

### Exporting a Single-Multiviewer Database

To export a single-multiviewer database

- 1 On the **Configure** menu, point to **Database**, and then click **Export**.

The **Export to Multiviewer** window appears, prompting you for the IP address of the multiviewer to which you wish to transfer the database.

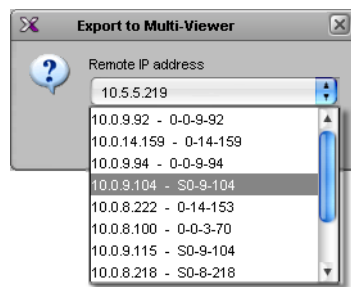

IP addresses for all the multiviewers that are on the same subnet as your PC are included in the list.

- 2 If your PC and the multiviewer are on the same subnet, then you can select the IP address of the multiviewer from the list. Otherwise type the appropriate IP address in the box.

- 3 Click **OK**.

A window appears, prompting you to confirm that you really want to export data to the multiviewer.

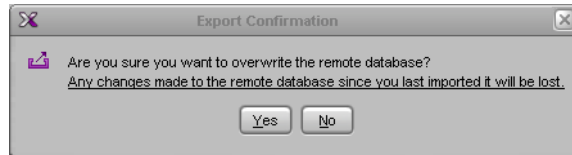

- 4 Click **Yes**.

- 5 If access control is enabled for this multiviewer, then XEdit prompts you for a password. Type the password associated with the RCP user "Admin", and then click **Log on**.



A progress window appears, followed by a message stating whether the export succeeded or not.

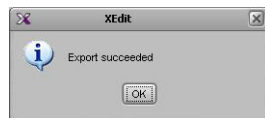
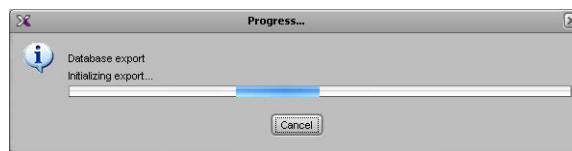

- 6 Click **OK**.

All data on the remote system is now replaced with content from the local workspace.

## Exporting a Cluster Database

### To export a cluster database

- 1 On the **Configure** menu, point to **Database**, and then click **Export**.

The **Export Cluster** window appears, prompting you to confirm the set of multiviewers to which you wish to apply the database.

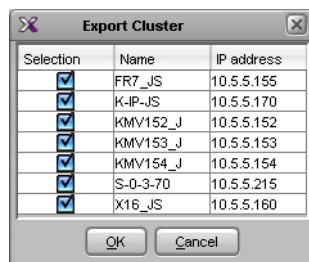

If you were working in offline mode, against a database imported from your existing cluster system, and all cluster members are currently available, then click **OK** to proceed.

On the other hand, if a cluster member happens to be unavailable, or if you are cloning a cluster configuration to a different set of multiviewers, you may need to remove members from the selection and change IP addresses.

#### IMPORTANT

Partial exports should be limited to cases where you had to replace a defective cluster member and need to bring its replacement into service without disrupting operations.

Before performing a partial export, you must verify that the cluster configuration has remained unchanged between your local version and the online version currently on the system.

- a To change an IP address, double-click an IP address, and then type the IP address of the actual multiviewer that is to receive this database.
- b To remove a cluster member that is currently not available from the selection, clear the corresponding check box.

Similarly, you may remove members if your target cluster does not have as many, or if you wish to update members that were previously unavailable with the same database you already exported to other cluster members.

- c Once the selected IP addresses match the actual multiviewers that are to receive the database, click **OK**.

In the case of a partial export, a warning appears prompting you to confirm your intention; click **OK** to proceed.

A window appears, prompting you to confirm that you really want to export the database.

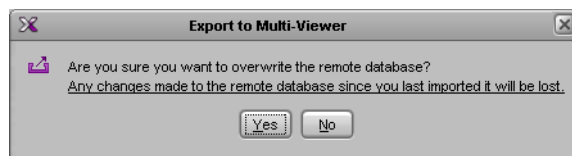

- 2 Click **Yes**.
- 3 If access control is enabled for a multiviewer, then XEdit prompts you for a password. Type the password associated with the RCP user "Admin", and then click **Log on**.

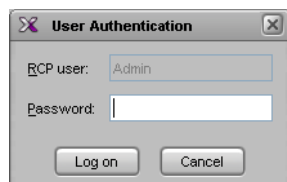

A progress window appears, followed by a message stating whether the export succeeded or not.

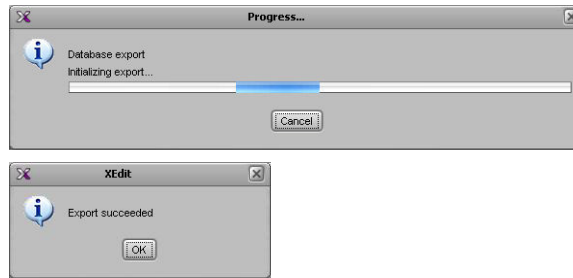

- 4 Click **OK**.

All cluster members now have the latest configuration from the local workspace.

## Creating a Backup

Use the **Create backup** and **Restore backup** functions to manage copies of your system database. This is equivalent to the usual **Save as** and **Open** functions, and is useful not only for security purposes but also on sites where more than one system must be maintained.

### Backing Up the Current Database

#### To back up the current system database

- 1 On the **Configure** menu, point to **Database**, then to **Create backup** and click **All**.  
The **Create Backup** window appears.
- 2 In **Create Backup**, select the location where you wish to save a backup copy of the current database content, and then click **Save**.  
The database is saved as a ZIP file.

### Backing Up Resolutions

#### To back up resolutions from the current system

- 1 On the **Configure** menu, point to **Database**, then to **Create backup** and click **Resolutions**.  
The **Create Backup** window appears.
- 2 In **Create Backup**, select the location where you wish to save a backup copy of the resolutions from the current database, and then click **Save**.  
The resolutions are saved as an XEdit collection file, with a `.xcol` extension.

### Backing Up Audio Scales

#### To back up audio scales from the current system

- 1 On the **Configure** menu, point to **Database**, then to **Create backup** and click **Audio scales**.  
The **Create Backup** window appears.
- 2 In **Create Backup**, select the location where you wish to save a backup copy of the audio scales from the current database, and then click **Save**.  
The audio scales are saved as an XEdit collection file, with a `.xcol` extension.

## Restoring a Backup

### Restoring a Database from a Backup

---

**Note:** When XEdit restores a *database backup*, it replaces the content of the local workspace with data from the backup. This cannot be undone. Always create a backup of the current data before restoring data from a different source. See [Managing Multiple Databases Efficiently](#) on page 116 for an overview of the recommended workflow.

---

#### To restore a backup database

- 1 On the **Configure** menu, point to **Database**, and then click **Restore backup**.  
The **Select Backup** window appears.
- 2 In **Select Backup**, navigate to the appropriate backup file (a ZIP archive, in the case of a full database backup), select it, and then click **Open**.

A message appears prompting you to confirm your intention.

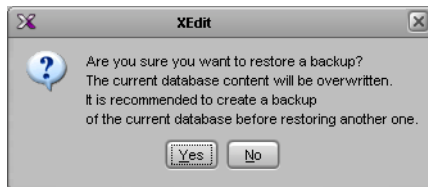

- 3 Click **Yes**.
- 4 Click **OK** to dismiss the message that appears once the operation has completed.  
The former content of the local workspace is entirely replaced with data from the backup.

### Restoring Resolutions or Audio Scales from a Backup

#### To restore resolutions or audio scales from a backup

- 1 On the **Configure** menu, point to **Database**, and then click **Restore backup**.  
The **Select Backup** window appears.
- 2 In **Select Backup**, navigate to the appropriate backup file (an XEdit collection file, with a `.xcol` extension), select it, and then click **Open**.

The content of the local workspace is updated with data from the backup.

---

**Note:** XEdit will *not* prompt for confirmation.

---

## Creating a Single Multiviewer System

When first opening XEdit in offline mode, the database contains the default configuration for a Kaleido-X (7RU) system, including a fully-populated frame (all cards present) as a starting point. If you have a different multiviewer model—i.e. a Kaleido-IP, a Kaleido-



Modular, a Kaleido-X16, a Kaleido-X (4RU) or an expansion system—, then you must replace this initial configuration with one that matches your actual system.

### Notes

- For the purpose of creating a system, an expansion system—Kaleido-X (14RU)—is considered as a single multiviewer.
- For instructions on creating a *cluster* system, see [Creating a Cluster](#), on page 88.
- For instructions on creating a *cascade* system, refer to the appropriate *Cascade Step-by-Step Configuration* guide, available on the Kaleido-X DVD, and from Grass Valley's support portal.

### To create a system with a single multiviewer

- 1 Open XEdit.
- 2 In the main window, click the **System** tab, and then click **Description/Calibrations** on the second-level tab bar.

The main pane displays the System hierarchical list, and the **Tools** pane displays the equipment library when the root of the System list is selected.

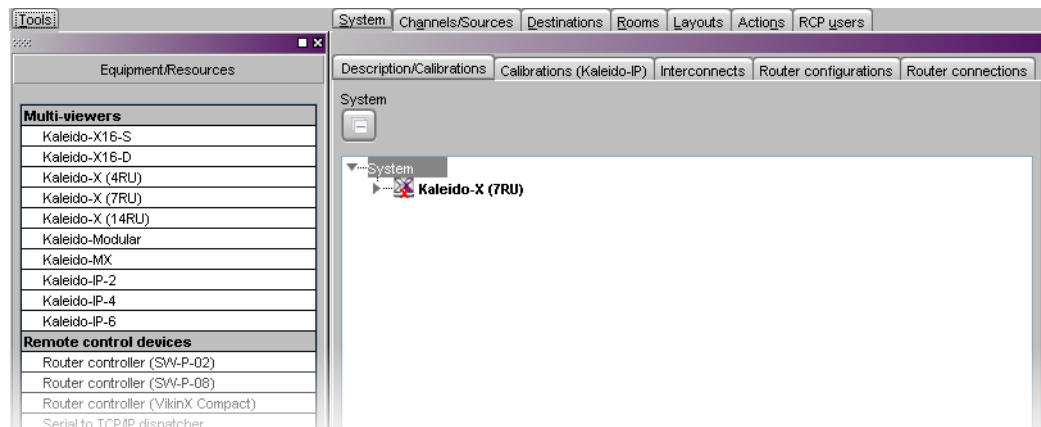

- 3 Right-click the current multiviewer in the System list, and then select the appropriate multiviewer model—**Kaleido-X16-S**, **Kaleido-X16-D**, **Kaleido-X (4RU)**, **Kaleido-X (7RU)**, **Kaleido-X (14RU)**, **Kaleido-Modular**, **Kaleido-MX**, **Kaleido-IP-2**, **Kaleido-IP-4**, or **Kaleido-IP-6**—, from the “replace with...” options on the menu.

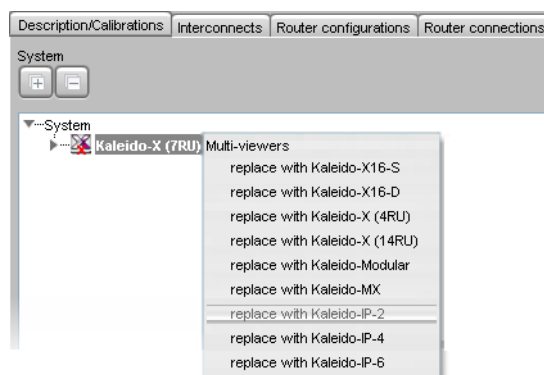

### Notes

If you are working in online mode, the set of multiviewer models available from the menu varies according to the current model. If the current model is a Kaleido-IP, then only the other Kaleido-IP models are available for selection.

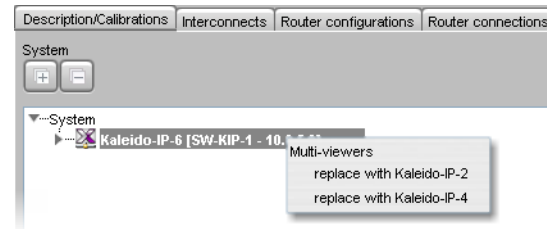

Conversely, if the current model is *not* a Kaleido-IP, then *none* of the Kaleido-IP models are available for selection.

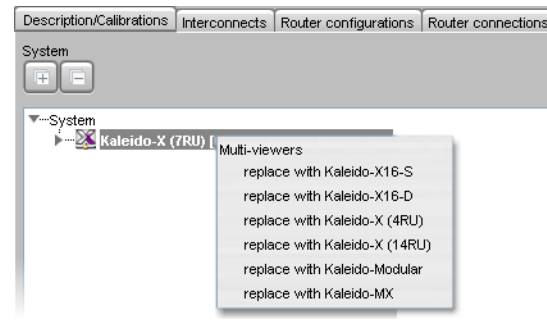

Select...	To represent a...
Kaleido-X16-S	Kaleido-X16 (single output)
Kaleido-X16-D	Kaleido-X16 (dual output)
Kaleido-X (4RU)	Kaleido-X (4RU)
Kaleido-X (7RU)	Kaleido-X (7RU)
Kaleido-X (14RU)	Two Kaleido-X (7RU) frames, with expansion cards
Kaleido-Modular	Any KMV-3901/3911, Kaleido-XQUAD, or Kaleido-XQUAD-DUAL
Kaleido-MX	Any Kaleido-MX, or Kaleido-Modular-X
Kaleido-IP-2	Kaleido-IP X300, or X100 with two network adapters
Kaleido-IP-4	Kaleido-IP X110, X310, or X300 with four network adapters
Kaleido-IP-6	Kaleido-IP X310, or X300 with six network adapters

A message appears, prompting you to confirm your intention.

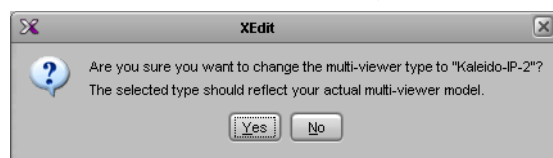

#### 4 Click **Yes**.

The next message prompts you about populating the database with a factory-default configuration for the selected multiviewer model.

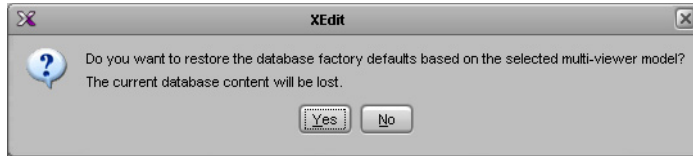

#### 5 Click **Yes** to have the system populated with factory defaults for the selected multiviewer model. See [Restoring Factory Defaults](#) on page 111.

Alternatively, click **No**, if this system is based on an existing multiviewer system whose room and layout configurations you wish to reuse. (For instance, you could be converting two 7RU multiviewers to an expansion system. Refer to the “Kaleido-X (7RU) Expansion” chapter in the *Kaleido-X (7RU) Hardware Description & Installation Manual* for more information.)

#### IMPORTANT

Databases created for different multiviewer models are not fully compatible with each other. It is important to select the proper model at this stage.

#### 6 Select the relevant peripheral devices in the equipment library and drag them onto the root of the System hierarchical list in the main window. Alternatively, right-click the list root, and then select the appropriate peripheral device from the “insert...” options on the menu.

All peripheral devices added to the system appear in the System list.

#### 7 If you are going to control the multiviewer, from a device using one of the supported TCP/IP router protocols (SW-P-02, SW-P-08, Network Modular, or NVISION Ethernet protocol - Compact router), then configure the router level to be controlled: click the multiviewer in the System list, and then, in the **Properties** pane, specify the logical router and level you wish to control, by selecting the appropriate values in the **Router** and **Router level** lists under **TCP/IP Router control**.

#### Notes

- As of version 5.00 of the Kaleido-X software, the router selected by default for TCP/IP control is the *KX Router* logical router
- To control the *KX Router* logical router from an external device or application, this device or application must support the *NVISION Ethernet protocol - Compact router* protocol (see [Built-in Communications Protocols](#), on page 333, for more information).

#### 8 On the **File** menu, click **Save**. Alternatively, click the Save button on the toolbar. Changes to the system are saved.

## Creating a Cluster

As of version 6.50 of the Kaleido-X software, clusters can be created and configured in offline mode, in addition to the previously supported online mode. Creating a cluster involves the following steps:

- 1 add multiviewers to your system
- 2 configure new rooms that include displays fed by the different multiviewers
- 3 create layouts for the new rooms
- 4 replicate RCP users from one multiviewer to all other systems that are part of the cluster
- 5 replicate custom display resolutions from one multiviewer to all others
- 6 make a backup of your cluster configuration

### IMPORTANT

It is important to follow the indicated sequence: **first** add the cluster members, then create **new** rooms, and only then create the layouts. Although first copying the same single-multiviewer database to the multiviewers you wish to join in a cluster may look like an option, this is not supported.

## Adding Multiviewers to a Cluster

---

### Notes

- Any multiviewer you wish to add to a cluster must have the Kaleido-X software version 4.00 or later, and all members of a cluster must have the same Kaleido-X software version.
- Each multiviewer you wish to add to a cluster must have a unique name.
- If you change the system name or IP address of a cluster member while another cluster member is offline or otherwise unavailable, the cluster's integrity will be broken. If you attempt to make such a change, XAdmin will alert you of the situation, prompting you to cancel the operation and try again later, when all cluster members are available. If you choose to force the change, then you will need to repair the cluster (see [Repairing a Cluster System](#), on page 93).
- Changing the system name or IP address of a KMV-3901/3911 multiviewer associated with a cluster, by using the card's control panel on the Densité housing frame, or by using the KMV-3901/3911 control panel in iControl, is not supported. If this happens, then you will need to repair the cluster (see [Repairing a Cluster System](#), on page 93).
- A multiviewer can only be part of one cluster system at any time. XEdit will not let you add a multiviewer that is already included in a different cluster system.

## Creating a cluster in online mode

### To create a system with multiple multiviewers in online mode

- 1 Open XEdit, and then click **Connect** on the **Configure** menu, to access one of the multiviewers you wish to be part of a cluster system. See [Connecting to a Multiviewer](#)

on page 76.

You are now ready to add more multiviewers to the system.

- 2 In the equipment library, select *any* multiviewer model, and then drag it onto the root of the System hierarchical list.

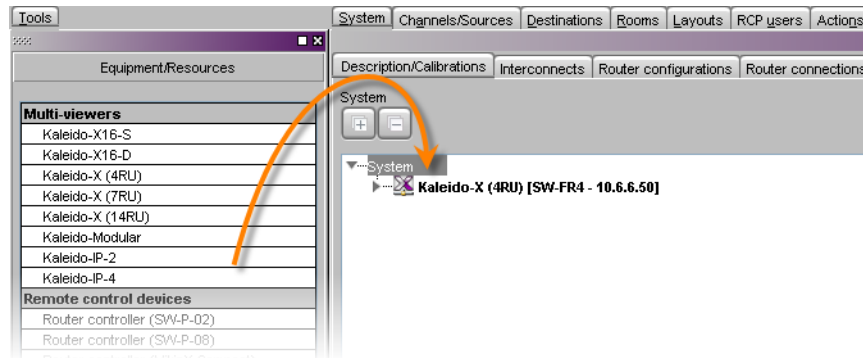

The **Add Multiviewer to Cluster** window appears.

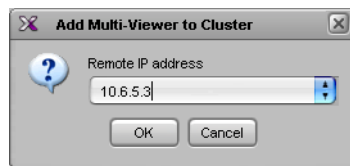

IP addresses for all the multiviewer systems that are on the same subnet as your PC are included in the list.

- 3 If your PC and the multiviewer you wish to add are on the same subnet, then you can select the multiviewer's IP address from the list. Otherwise enter the appropriate IP address in the box.

The multiviewer is added to the System list.

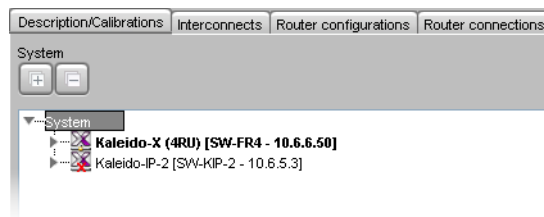



---

**Note:** The appropriate multiviewer model is automatically selected, based on the actual target system.

---

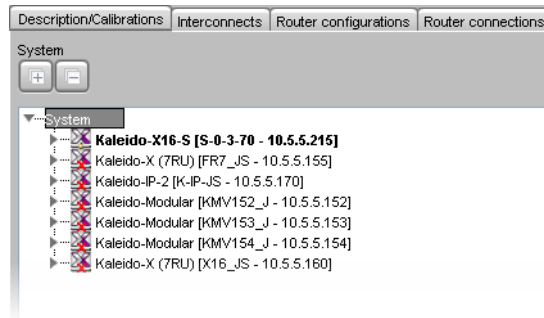
- 4 Repeat from [step 2](#) until you have added all the required devices to the cluster.



- 5 If further system configuration is required on the individual members of the cluster, start with the current system (i.e. the one you are connected to). See [Configuring the System Representation](#) on page 94, for detailed instructions on adding cards to a Kaleido-X (4RU, 7RU, or 14RU), or on adding streams to a Kaleido-IP configuration. Refer to [Routers & Kaleido-X](#), on page 325, and [Tally Interface Devices & Timer Systems](#), on page 375, for instructions on adding other routing and control devices.

---

**Note:** Each member of a cluster has its own database where both common information about the cluster and information local to the individual cluster member are stored. Room and layout definitions are automatically replicated to all cluster members, whereas the logical sources and the configuration of devices connected to a specific cluster member are only stored in this member's database.

---

- 6 Once you have completed the current system's specific configuration, save it, and then connect to the next cluster member you need to configure: right-click the appropriate multiviewer node and then click **Connect to this system**.

Once the connection is established, the selected system becomes highlighted in the System list, and the message "Connected to..." appears in the status bar.

- 7 Repeat from [step 5](#) until all cluster members are configured.

---

**Note:** In the hierarchical list for a cluster, an unavailable system is indicated by a dimmed icon and cannot be expanded. It can take up to 15 seconds before a multiviewer's status icon is updated in the System list.

---

## Creating a cluster in offline mode

### To create a system with multiple multiviewers in offline mode

- 1 In the equipment library, select the appropriate multiviewer model—**Kaleido-X16-S**, **Kaleido-X16-D**, **Kaleido-X (4RU)**, **Kaleido-X (7RU)**, **Kaleido-X (14RU)**, **Kaleido-Modular**, **Kaleido-MX**, **Kaleido-IP-2**, **Kaleido-IP-4**, or **Kaleido-IP-6**—, and drag it onto the root of the System hierarchical list.

Alternatively, right-click the list root, and then click the appropriate multiviewer model on the "insert..." menu.

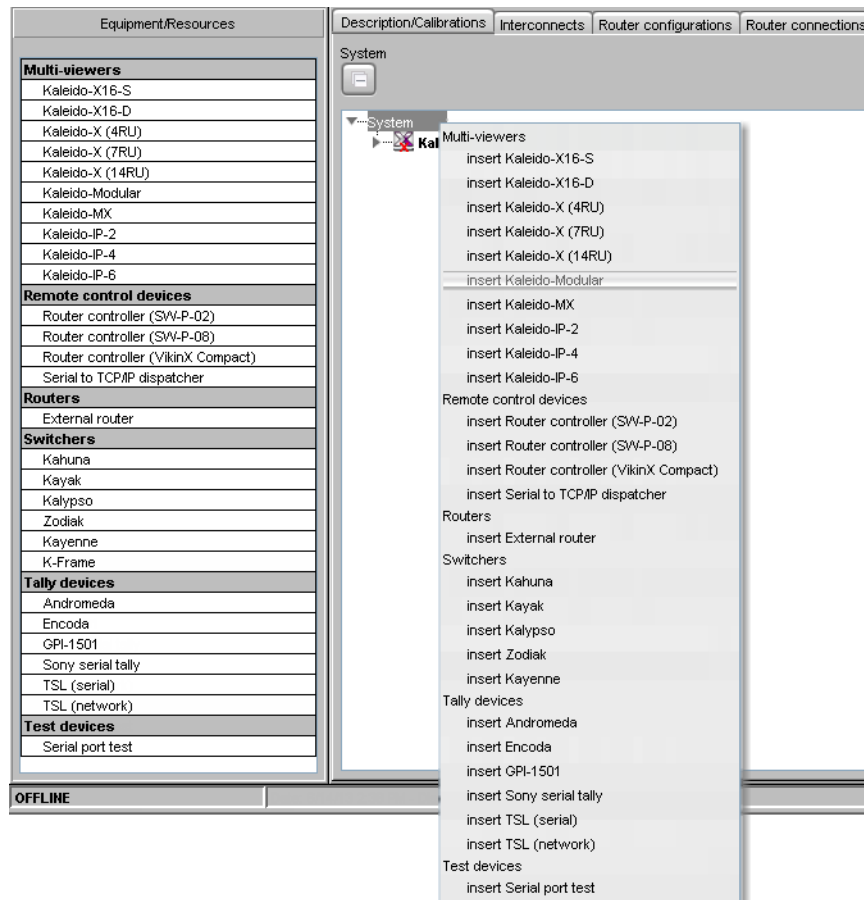

2 A multiviewer of the selected model is added to the System list.



3 On the File menu, click Save.

A progress window appears while XEdit applies default settings to your new cluster configuration.

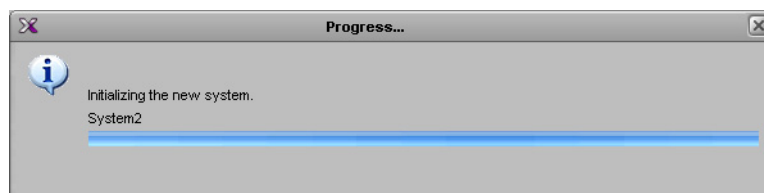

4 Repeat from step 1 until you have added all the required devices to the cluster.

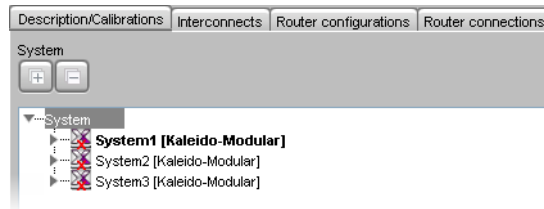

- 5 If further system configuration is required on the individual members of the cluster, start with the current system (i.e. the one that is highlighted). See [Configuring the System Representation](#) on page 94, for detailed instructions on adding cards to a Kaleido-X (4RU, 7RU, or 14RU), or on adding streams to a Kaleido-IP configuration. Refer to [Routers & Kaleido-X](#), on page 325, and [Tally Interface Devices & Timer Systems](#), on page 375, for instructions on adding other routing and control devices.

---

**Note:** Each member of a cluster has its own database where both common information about the cluster and information local to the individual cluster member are stored. Room and layout definitions are automatically replicated to all cluster members, whereas the logical sources and the configuration of devices connected to a specific cluster member are only stored in this system's database.

---

- 6 Once you have completed the current system's specific configuration, save it, and then switch to the next cluster member you need to configure: right-click the appropriate multiviewer node and then click **Switch to this system**.

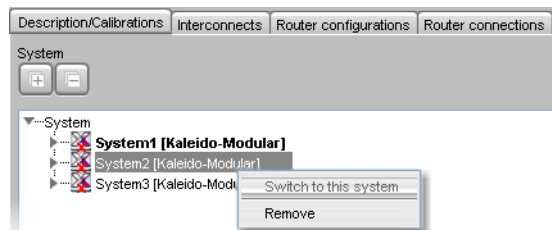

The selected cluster member becomes highlighted in the System list.

- 7 Repeat from [step 5](#) until all cluster members are configured.
- 8 On the **File** menu, click **Save**.

Eventually, you will want to export this cluster configuration to the appropriate set of multiviewers. See [Exporting a Cluster Database](#) on page 81 for details.



---

## Creating Rooms for a Cluster System

Create rooms for the cluster system, by adding displays associated with the different multiviewers as appropriate. See [Setting Up Rooms](#) on page 195, for details.

---

### Notes

- Each room must have a unique name across the cluster system. XEdit will not let you use a name if there is already a room with this name associated with one of the multiviewers within the cluster.
  - All multiviewers associated with the cluster system must be available. If one of the member multiviewers becomes unavailable while you were configuring a room for the cluster system, then XEdit will not let you save the room. If you wish to save the room anyway, first remove any unavailable system from the cluster.
- 

## Creating Layouts for a Cluster System

It is possible to create a partial layout for a cluster system in offline mode, and then export it to the appropriate multiviewer for further online configuration. When configuring a layout for a room that is associated with a cluster system, you only work on one part at a time: the part that is associated with the current multiviewer's output heads. See [Creating Layouts](#) on page 217 for detailed instructions.

---

**Note:** Each layout must have a unique name across the cluster system. XEdit will not let you export a layout to a cluster system if there is already a layout with this name associated with one of the multiviewers within the cluster. As a workaround, you could make a copy of one of the conflicting layouts under a different name, and then delete the original before proceeding with the export (see [Copying layouts](#), on page 231, [Deleting Layouts](#), on page 228).

---

## Replicating RCP Users Across a Cluster System

Currently, RCP Users are not automatically propagated to all multiviewers. Before a user can log on to a room associated with a cluster system, the corresponding RCP user configuration must be manually replicated on all member multiviewers across the cluster.

## Repairing a Cluster System

---

**Note:** In the procedure below, *System A* refers to the system whose name or IP address was changed while another cluster member, referred to as *System B*, was unavailable.

---

### To repair the cluster configuration

- 1 In XEdit, connect to *System B*, the multiviewer that was unavailable when the change was made, once it is available again.
- 2 In the **Description/Calibrations** tab, remove *System A* from the cluster, and then add it back to the cluster.
- 3 If other cluster members were unavailable when the change was made (e.g. if *System A* is a KMV-3901/3911 whose name or IP address was changed from the Densité frame's

control panel, or from the KMV-3901/3911 control panel in iControl, then repeat the previous steps for each.

If only the IP address was changed then no further action is required. Otherwise, if the system name was changed, then proceed as follows.

- 4 Connect to *System A*.
- 5 Change something in every room (e.g. move a display and then bring it back to its initial position) to enable the **Save** button.
- 6 Save the room.  
This will replicate the proper room configuration to the other members of the cluster. (At the same time, the layouts will also be updated on all multiviewers in the cluster.)

## Configuring the System Representation

- The **Kaleido-IP** has two, four, or six network adapters, depending on the model, and two multiviewer outputs. Configuring your Kaleido-IP's system representation in XEdit includes adding or removing transport streams until the representation matches the set of transport streams you wish to monitor. See [Managing Transport Streams in a Kaleido-IP System Representation](#) below, for details.
- In the case of a **Kaleido-MX**, **Kaleido-Modular-X**, **Kaleido-X (4RU)**, **Kaleido-X (7RU)**, or **expansion** system, configuring your system's representation in XEdit includes adding or removing cards until the representation matches the hardware configuration of your actual multiviewer. See [Managing Cards in a Kaleido-X, or Kaleido-MX System Representation](#) on page 109, for details.
- This section does not apply to the **Kaleido-X16**, **Kaleido-XQUAD**, and **KMV-3901/3911**, which have a set number of *virtual card slots* that represent hardware features integrated within their main board. In XEdit, these virtual card slots are, for the most part, equivalent to their physical counterparts on the Kaleido-X models (see [page 72](#)).

### Managing Transport Streams in a Kaleido-IP System Representation

Although it is possible to partly configure your Kaleido-IP system by using XEdit in offline mode, you must work in online mode, at least once, to obtain the list of programs and elementary streams under each transport stream (see [Using XEdit Online](#), on page 75). The supported stream types are source-specific multicast, source-filtered multicast (filtering limited to a single source IP in include mode only), any-source multicast, unicast, and HTTP Live Streaming (HLS).

If you need to monitor a large number of programs, you may find it convenient to import related configuration information, from a spreadsheet in XLS or XLSX format. At the same time, the logical sources associated with the programs specified in the spreadsheet will be automatically added to the sources table. A sample spreadsheet is available on the DVD that shipped with your system, and from Grass Valley's support portal.

- To prepare your spreadsheet, see [Preparing a spreadsheet with stream lineup information](#), on page 96.
- Once you have prepared your spreadsheet, refer to [Importing a stream lineup](#), on page 95.
- To add SSM or SFM transport streams, manually, see [Adding source-specific or source-filtered multicast transport streams](#), on page 99.

- To add ASM transport streams, manually, see [Adding any-source multicast transport streams](#), on page 101.
- To add unicast transport streams, manually, see [Adding unicast transport streams](#), on page 103.
- To add HTTP Live Streaming (HLS) streams, manually, see [Adding HLS transport streams](#), on page 105.
- To modify transport stream information, see [Modifying transport streams](#), on page 106.
- To remove transport streams from your system configuration, see [Removing transport streams](#), on page 108.

### Importing a stream lineup

#### WARNING

Grass Valley recommends making a backup of your system before importing stream configuration information from a spreadsheet. When you import streams from a spreadsheet, this erases all previously imported streams and associated logical sources. It may also overwrite streams that you had manually added (and logical sources) if they have the same name or index as a stream whose configuration is being imported.

### To import a set of streams from a spreadsheet file

- 1 In the main window, click the **System** tab, and then click **Description/Calibrations** on the second level tab bar.
- 2 On the **File** menu, click **Import**.  
XEdit prompts you for confirmation.

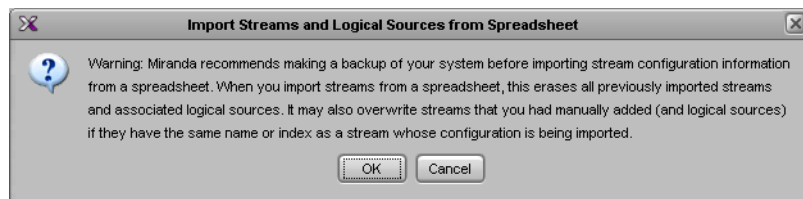

- 3 Click **OK** to dismiss the warning, if you are confident that you have all the information to recover your system configuration if needed.
- 4 Navigate to the spreadsheet file you wish to import, select it, and then click **Open**.  
XEdit validates the following: IP address range, network adapter number, protocol, consistency of stream name vs. stream information (group and source IP addresses + port), duplicate stream names, duplicate logical source information (category + name), duplicate logical source index, and will report any error. If no errors were found, then the following message appears.

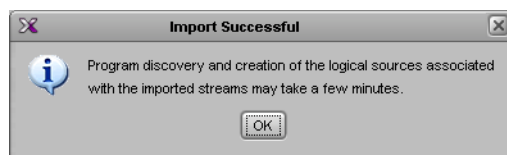

- 5 Click **OK** to dismiss the message.  
The streams appear under the specified network adapters.

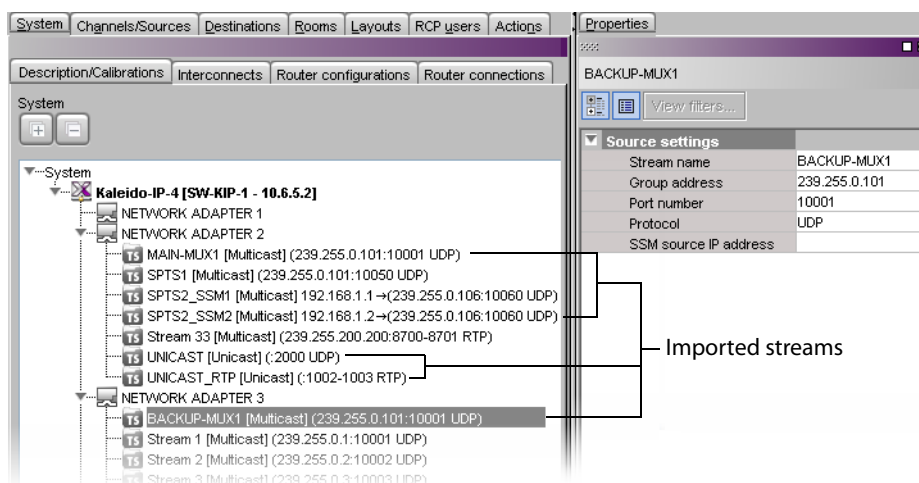

Example showing streams imported from the sample spreadsheet file.

After a few minutes, if XEdit is connected to the multiviewer, all programs included in the transport streams are discovered.

**Note:** The set of discovered programs does not necessarily match the programs listed in the spreadsheet. The discovery being a dynamic process, it may find more (or less) programs.

In addition, logical sources for the programs listed in the spreadsheet you imported are automatically added to the sources table. If XEdit is not connected to the multiviewer, then the new sources' video levels appear in red in the sources table. In such case, the sources table will be updated when you work in online mode once you have exported the database to the multiviewer.

Channels/Sources	Source info			Video
	#	Cat.	Name	video1
/BACKUP-MUX1/101	43	BACKUP-MUX1	101	PG-NUM:101 ES-PID-ORD:1
/BACKUP-MUX1/201	44	BACKUP-MUX1	201	PG-NUM:201 ES-PID-ORD:1
/MAIN-MUX1/101	41	MAIN-MUX1	101	PG-NUM:101 ES-PID-ORD:1
/MAIN-MUX1/201	42	MAIN-MUX1	201	PG-NUM:201 ES-PID-ORD:1
/MyCategory/Example1	45	MyCategory	Example1	PG-NUM:10001 ES-PID-ORD:1
/MyCategory/Example2	46	MyCategory	Example2	PG-NUM:505 ES-PID-ORD:1
/MyCategory/Example3	47	MyCategory	Example3	PG-NUM:505 ES-PID-ORD:1
/MyCategory/Example4	48	MyCategory	Example4	PG-NUM:1 ES-PID-ORD:1
/MyCategory/Example5	49	MyCategory	Example5	PG-NUM:1 ES-PID-ORD:1
/Stream 1/PG-NUM1		Stream 1	PG-NUM1	PG-NUM:1 ES-PID-ORD:1
/Stream 1/PG-NUM137	1	Stream 1	PG-NUM137	PG-NUM:137 ES-PID-ORD:1
/Stream 1/PG-NUM138	2	Stream 1	PG-NUM138	PG-NUM:138 ES-PID-ORD:1
/Stream 1/PG-NUM139	3	Stream 1	PG-NUM139	PG-NUM:139 ES-PID-ORD:1
/Stream 1/PG-NUM163	4	Stream 1	PG-NUM163	PG-NUM:163 ES-PID-ORD:1
/Stream 1/PG-NUM165		Stream 1	PG-NUM165	PG-NUM:165 ES-PID-ORD:1

Logical sources created from imported programs

Should you wish to add audio, dynamic text, alarm and time code levels to these logical sources, you may complete all desired physical assignments for one logical source, which you can then designate as the *template*. By applying the template, you will be able to populate the remaining levels in a single operation. See [Defining Physical Assignments](#) on page 185, for more information.

### Preparing a spreadsheet with stream lineup information

The spreadsheet file must contain the following:

- information about the *programs* you wish to monitor, and the *transport streams* to which they belong,
- information about the *logical sources* that will be added to the sources table for these programs, including any *static text levels* you may wish to add.

---

#### Notes

- Kaleido-IP X310 and Kaleido-IP X110 multiviewers support 6000 logical sources.
  - In the case of the Kaleido-IP X300, to support more than 1500 sources, the multiviewer's RAM must be upgraded to 24 GB. Refer to the "Kaleido-IP X300 Memory Modules" section, in the Kaleido-X Release Notes, for installation instructions.
  - The Kaleido-IP X100 is limited to 1500 sources.
  - HTTP and HTTPS are not supported by the spreadsheet import.
- 

The spreadsheet is organized as follows:

- Two heading rows. The first heading row divides the spreadsheet into four main areas:
  - Programs. This area occupies the first column (A).
  - Transport streams. This area spans columns B–G.
  - Logical sources. This area spans columns H–J.
  - Additional static text levels (optional). This area starts at column K, and can extend to as many columns as you need. Text you enter on the second heading row in this area will be imported.
- One row for every program you wish to monitor.

#### To prepare the spreadsheet file

- 1 Using your spreadsheet software, either open a copy of the sample spreadsheet file or create a new spreadsheet.
- 2 Enter the information about a program, and the transport stream to which it belongs:

In this column...		Enter this information...
A	Program number	The program number (MPEG ID), for the program you wish to monitor.
B	Stream name	A name to identify the transport stream that includes this program. Alternatively, you can leave this cell blank, in which case a default name will be created. Stream names that only contain digits <i>and have decimal positions that are all zeros</i> must be preceded with an apostrophe in the spreadsheet.
C	Multicast group IP address	The multicast group IP address. In the case of a unicast stream, leave the cell blank.
D	Port number	The appropriate port number.
E	SSM/SFM source IP address	In the case of a source-specific multicast (SSM) or source-filtered multicast (SFM) transport stream, enter the source IP address.

In this column...		Enter this information...
F	Protocol	RTP, or UDP.
G	NIC	The network adapter identifier: LAN2 – LAN5, for a high-bitrate stream; LAN1, for a low-bitrate stream. The number of network adapters varies, depending on the Kaleido-IP model (see <a href="#">Kaleido-IP</a> , on page 70).

	A	B	C	D	E	F	G
1	<b>Programs</b>	<b>Transport streams (SPTS or MPTS)</b>					
2	Program number (MPEG ID)	Stream name (if left blank a default name will be created)	Multicast group IP address (leave blank for unicast stream)	Port number	SSM/SFM source IP address (leave blank if not used)	Protocol (RTP/UDP)	NIC (LAN1 to LAN6)
3	101	MAIN-MUX1	239.255.0.101	10001		UDP	LAN2
4	201	MAIN-MUX1	239.255.0.101	10001		UDP	LAN2
5	101	BACKUP-MUX1	239.255.0.101	10001		UDP	LAN3
6	201	BACKUP-MUX1	239.255.0.101	10001		UDP	LAN3
7	10001	SPTS1	239.255.0.101	10050		UDP	LAN2
8	505	SPTS2_SSM1	239.255.0.106	10060	192.168.1.1	UDP	LAN2
9	505	SPTS2_SSM2	239.255.0.106	10060	192.168.1.2	UDP	LAN2
10	1	UNICAST		2000		UDP	LAN2
11	1	UNICAST_RTP		1002		RTP	LAN2
12							
13							

Sample spreadsheet: Programs, and Transport streams areas

- 3 Enter the information that will be used to create the logical source associated with this program:

In this column...		Enter this information...
H	Index	If your system involves a control panel from which you control your multiviewer as a router, set a source number for the logical source associated with this program to be available through the <i>KX Router</i> logical router, by entering the appropriate number in this column. Source numbers must be unique.
I	Category	Text in this column can be used to group related logical sources together, when you sort the sources table in XEdit (see <a href="#">Sorting the Sources Table</a> , on page 190). The category text can have up to 200 characters.
J	Name	The name of the logical source. Names are limited to 48 characters. Logical source names that only contain digits <i>and have decimal positions that are all zeros</i> must be preceded with an apostrophe in the spreadsheet.

H	I	J
<b>Logical sources</b>		
Category/Name must be unique		
Index must be unique		
Index	Category	Name
41	MAIN-MUX1	101
42	MAIN-MUX1	201
43	BACKUP-MUX1	101
44	BACKUP-MUX1	201
45	MyCategory	Example1
46	MyCategory	Example2
47	MyCategory	Example3
48	MyCategory	Example4
49	MyCategory	Example5

Sample spreadsheet: Logical sources area

- Optionally, use the columns, starting at column K, to add static text levels. Enter the level name on the second heading row.

K	L	M	N
<b>Additional static text levels</b>			
for logical sources			
[Name of static text level 1]	[Name of static text level 2]	[Name of static text level 3]	[Name of static text level 4]
MyText1	st2-1	st3-1	st4-1
MyText2	st2-2	st3-2	st4-2
MyText3	st2-3	st3-3	st4-3
MyText4	st2-4	st3-4	st4-4
MyText5	st2-5	st3-5	st4-5
MyText6	st2-6	st3-6	st4-6
MyText7	st2-7	st3-7	st4-7
MyText8	st2-8	st3-8	st4-8
MyText9	st2-9	st3-9	st4-9

Sample spreadsheet: Additional static text levels area

Static text level names and data that only contain digits *and have decimal positions that are all zeros* must be preceded with an apostrophe in the spreadsheet.

- Repeat this procedure until you have added the required information for all the programs you wish to monitor.

### Adding source-specific or source-filtered multicast transport streams

#### To add a source-specific multicast (SSM) or source-filtered multicast (SFM) transport stream

- In the main window, click the **System** tab, and then click **Description/Calibrations** on the second level tab bar.
- Expand the System hierarchical list, and then click the appropriate network adapter element, for the stream you wish to add:
  - NETWORK ADAPTER 2** for a high-bitrate stream;

- alternatively, **NETWORK ADAPTER 3, 4, 5, or 6**, for a high-bitrate stream, in the case of a four-port or six-port Kaleido-IP model;
- optionally, **NETWORK ADAPTER 1** for a low-bitrate stream.

The supported stream types (**Multicast, Unicast, HTTP**) are listed in the **Tools** pane.

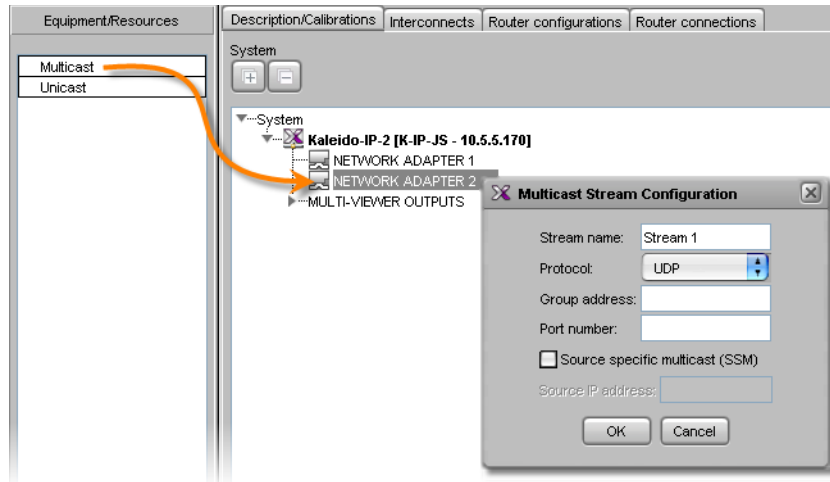

- 3 Drag **Multicast** from the **Tools** pane onto the network adapter.  
The **Multicast Stream Configuration** window appears.
- 4 In **Multicast Stream Configuration**, replace the default stream name if desired, select the appropriate protocol (RTP, UDP), type the multicast group address and port number associated with the transport stream you wish to add.

#### Notes

- The Kaleido-X software supports UTF-8 encoded stream names. The only characters, which cannot be used in a stream name are: @ / \ ' and ".
- Verify the protocol you selected. Registering an RTP stream as UDP instead of RTP may result in the decoded video appearing jerky or accelerated on the monitor wall.

- 5 Select the **Source specific multicast (SSM)** check box, type the IP address associated with the specific source you wish to monitor in the **Source IP address** box, and then click **OK**.

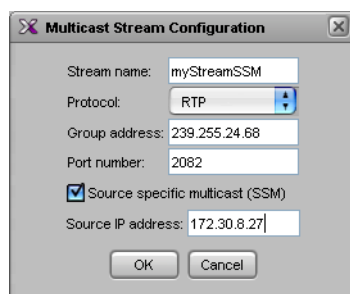

**Note:** In the case of streams that are available from the same multicast group address and port number, you must enter the source IP address associated with a stream before you can add the next one.



The Kaleido-IP establishes a connection with the selected SSM/SFM stream. All programs that are part of the selected stream, and the elementary streams included in these programs, automatically appear under the transport stream element in the System list.

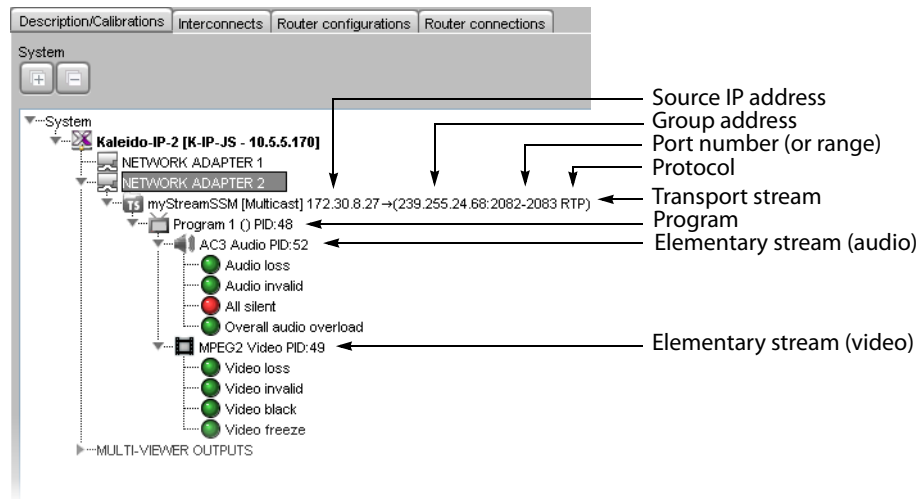

**Note:** Under the network adapter elements, transport streams are listed in alphabetical order.

- 6 Repeat this procedure until you have added all required SSM/SFM transport streams to your system configuration.
- 7 On the **File** menu, click **Save**. Alternatively, click the Save button on the toolbar. Changes to the system are saved.

### Adding any-source multicast transport streams

#### To add an any-source multicast (ASM) transport stream

- 1 In the main window, click the **System** tab, and then click **Description/Calibrations** on the second level tab bar.
- 2 Expand the System hierarchical list, and then click the appropriate network adapter element, for the stream you wish to add:
  - **NETWORK ADAPTER 2** for a high-bitrate stream;
  - alternatively, **NETWORK ADAPTER 3, 4, 5, or 6**, for a high-bitrate stream, in the case of a four-port or six-port Kaleido-IP model;
  - optionally, **NETWORK ADAPTER 1** for a low-bitrate stream.

The supported stream types (**Multicast, Unicast, HTTP**) are listed in the **Tools** pane.

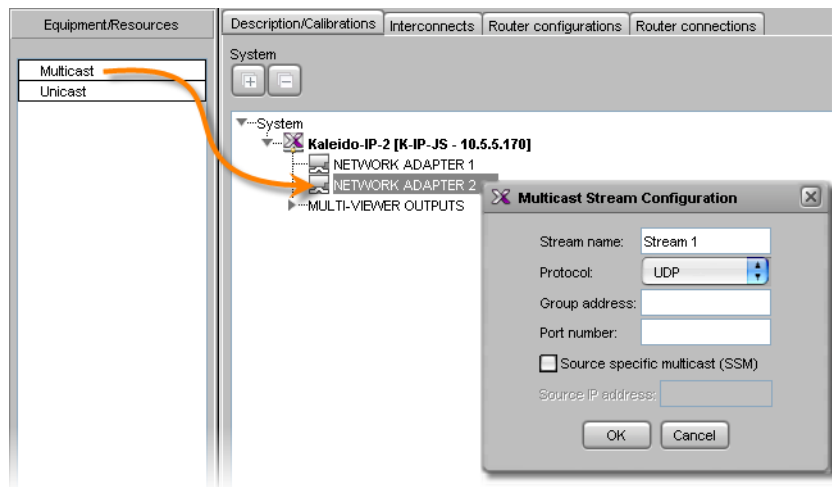

- 3 Drag **Multicast** from the **Tools** pane onto the network adapter.  
The **Multicast Stream Configuration** window appears.
- 4 In **Multicast Stream Configuration**, replace the default stream name if desired, select the appropriate protocol (RTP, UDP), type the multicast group address and port number associated with the transport stream you wish to add, and then click **OK**.

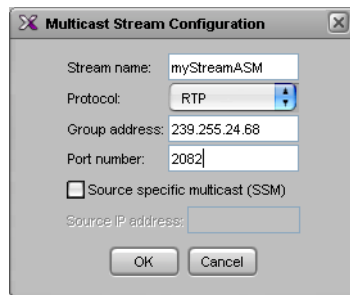

---

### Notes

- The Kaleido-X software supports UTF-8 encoded stream names. The only characters, which cannot be used in a stream name are: @ / \ ' and ".
  - Verify the protocol you selected. Registering an RTP stream as UDP instead of RTP may result in the decoded video appearing jerky or accelerated on the monitor wall.
- 

The Kaleido-IP establishes a connection with the selected stream. All programs that are part of the stream, and the elementary streams included in these programs, automatically appear under the transport stream element in the System list.

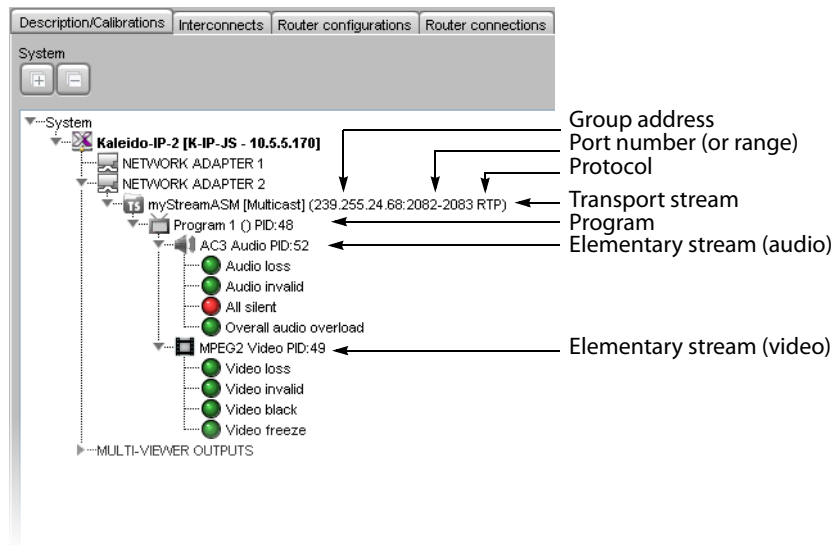

Note: Under the network adapter elements, transport streams are listed in alphabetical order.

- 5 Repeat this procedure until you have added all required ASM transport streams to your system configuration.
- 6 On the **File** menu, click **Save**. Alternatively, click the Save button on the toolbar. Changes to the system are saved.

### Adding unicast transport streams

#### To add a unicast transport stream

- 1 In the main window, click the **System** tab, and then click **Description/Calibrations** on the second level tab bar.
- 2 Expand the System hierarchical list, and then click the appropriate network adapter element, for the stream you wish to add:
  - **NETWORK ADAPTER 2** for a high-bitrate stream;
  - alternatively, **NETWORK ADAPTER 3, 4, 5, or 6**, for a high-bitrate stream, in the case of a four-port or six-port Kaleido-IP model;
  - optionally, **NETWORK ADAPTER 1** for a low-bitrate stream.

The supported stream types (**Multicast, Unicast, HTTP**) are listed in the **Tools** pane.

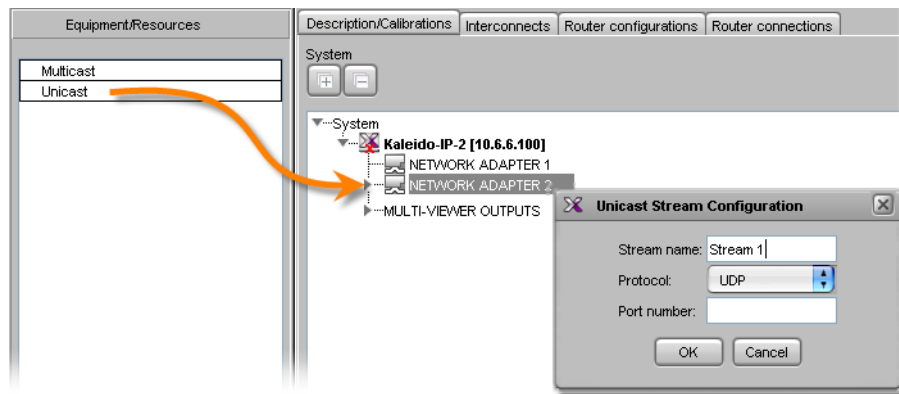

- 3 Drag **Unicast** from the **Tools** pane onto the network adapter element.  
The **Unicast Stream Configuration** window appears.
- 4 In **Unicast Stream Configuration**, replace the default stream name if desired, select the appropriate protocol (RTP, UDP), type the port number associated with the transport stream you wish to add, and then click **OK**.

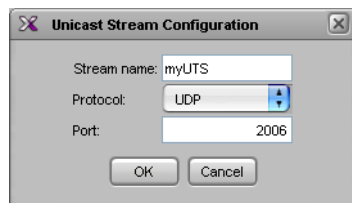

The Kaleido-IP establishes a connection with the selected stream. All programs that are part of the stream, and the elementary streams included in these programs, automatically appear under the transport stream element in the System list.

---

### Notes

- The Kaleido-X software supports UTF-8 encoded stream names. The only characters, which cannot be used in a stream name are: @ / \ ' and ".
  - Verify the protocol you selected. Registering an RTP stream as UDP instead of RTP may result in the decoded video appearing jerky or accelerated on the monitor wall.
  - When adding unicast transport streams do not specify consecutive port numbers.
  - Under the network adapter elements, transport streams are listed in alphabetical order.
- 

- 5 Repeat this procedure until you have added all required unicast transport streams to your system configuration.
- 6 On the **File** menu, click **Save**. Alternatively, click the Save button on the toolbar. Changes to the system are saved.

## Adding HLS transport streams

**Note:** HLS streams are handled via the multiviewer's *management* port, based on your network's configuration. Make sure the multiviewer's DNS and proxy settings are properly configured for your network, and that NTP synchronization is enabled (refer to the *Quick Start Guide* that shipped with your Kaleido-IP, for more information).

### To add an HLS transport stream

- 1 In the main window, click the **System** tab, and then click **Description/Calibrations** on the second level tab bar.
- 2 Expand the System hierarchical list, and then click **NETWORK ADAPTER 1**.  
The supported stream types (**Multicast**, **Unicast**, **HTTP**) are listed in the **Tools** pane.
- 3 Drag **HTTP** from the **Tools** pane onto the network adapter element.

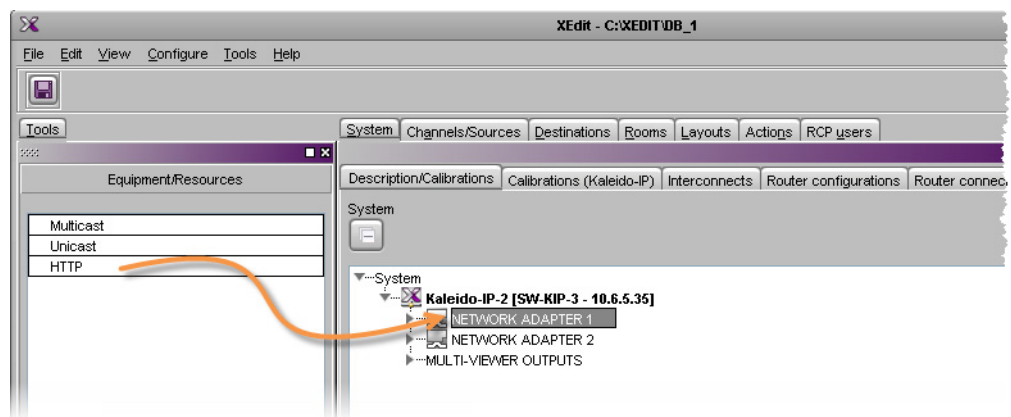

The **HTTP Stream Configuration** window appears.

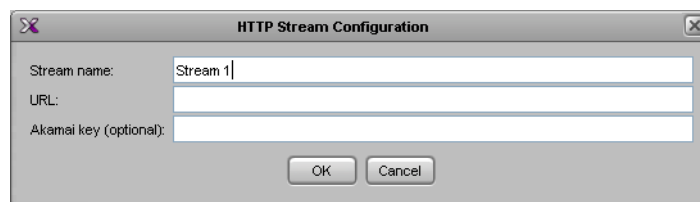

- 4 In **HTTP Stream Configuration**, replace the default stream name if desired, type the URL of the playlist you wish to monitor, provide the appropriate Akamai authentication key if required, and then click **OK**.

The Kaleido-IP establishes a connection with the stream providers. In the case of a master playlist, all transport streams automatically appear under the network adapter, in the System list. All programs that are part of a stream, and the elementary streams included in these programs, automatically appear under the transport stream element.

### Notes

- The Kaleido-X software supports UTF-8 encoded stream names. The only characters, which cannot be used in a stream name are: @ / \ ' and ".
- Both HTTP and HTTPS protocols are supported. If HTTPS is used, there must be a valid certificate for the connection to be established.

---

Notes *(continued)*

- Support for master playlists is in a beta stage.
  - Under the network adapter elements, transport streams are listed in alphabetical order.
- 

- 5 Repeat this procedure until you have added all required HLS transport streams to your system configuration.
- 6 On the **File** menu, click **Save**. Alternatively, click the **Save** button on the toolbar. Changes to the system are saved.

### Modifying transport streams

#### To modify the settings for a transport stream

- 1 In the main window, click the **System** tab, and then click **Description/Calibrations** on the second level tab bar.
- 2 Expand the System hierarchical list, and then navigate to the transport stream you wish to configure.

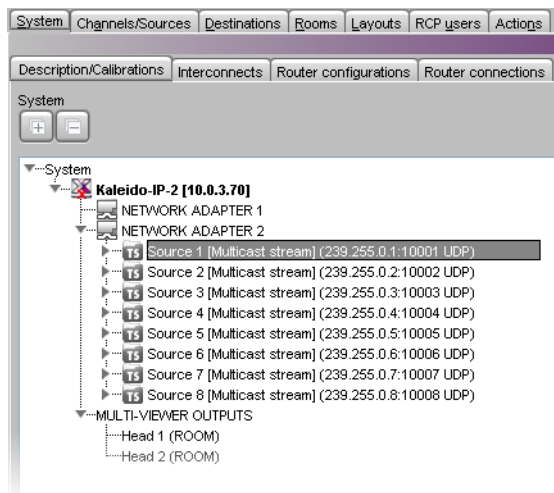

---

**Note:** Under the network adapter elements, transport streams are listed in alphabetical order.

---

The settings for the selected stream appear in the **Properties** pane.

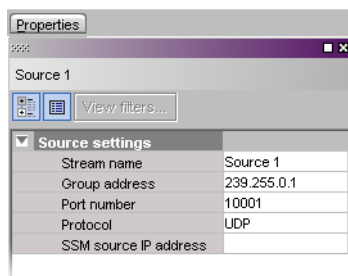

*Stream source settings (example showing settings for an any-source multicast stream)*

- 3 Replace the default stream name if desired, select the appropriate protocol (RTP, UDP), and enter the multicast group IP address (in the case of a multicast stream) and port number associated with the actual transport stream you wish to monitor. In the case of an SSM (or SFM) stream, enter the IP address associated with the specific source you wish to monitor in the **SSM source IP address** box. In the case of an HLS stream, enter the new URL.

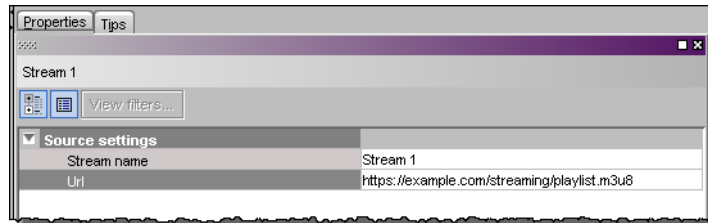

*Properties pane of HLS Transport stream*

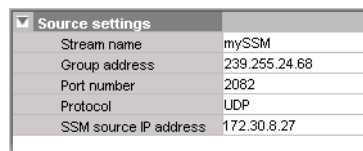

*Properties pane of Multicast Transport stream*

### Notes

- The Kaleido-X software supports UTF-8 encoded stream names. The only characters, which cannot be used in a stream name are: @ / \ ' and ".
- Verify the protocol you selected. Registering an RTP stream as UDP instead of RTP may result in the decoded video appearing jerky or accelerated on the monitor wall.
- For HLS streams, both HTTP and HTTPS protocols are supported.

The Kaleido-IP establishes a connection with the selected stream. All programs that are part of the stream, and the elementary streams included in these programs, automatically appear under the transport stream element in the System list.

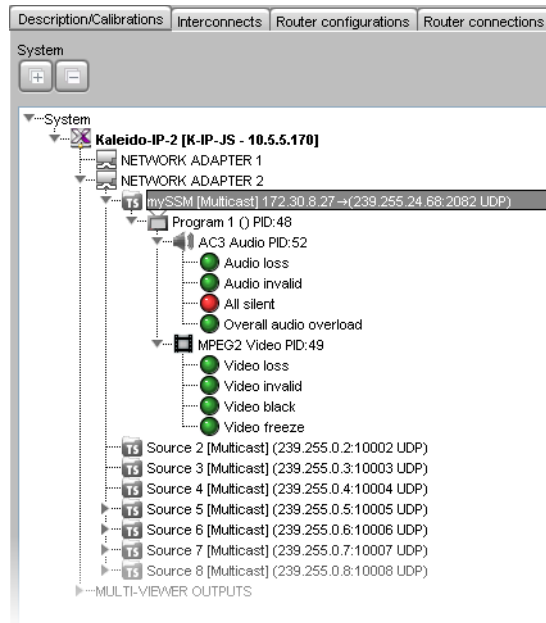

## Removing transport streams

### To remove transport streams from your system configuration

- 1 In the main window, click the **System** tab, and then click **Description/Calibrations** on the second level tab bar.
- 2 Expand the System hierarchical list, and then navigate to the multicast transport stream you wish to remove.
- 3 If you wish to remove multiple transport streams in a single operation, then extend your selection by using the standard Shift+click or Ctrl+click keyboard shortcuts.
- 4 Right-click the selection, and then click **Remove**.

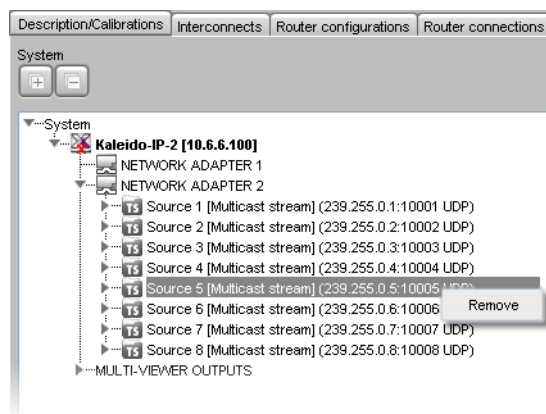

- 5 When prompted to confirm, click **Yes**.
- 6 On the **File** menu, click **Save**.

Changes to the system are saved. If you are not planning on adding these streams back to your system, then you may now wish to remove logical sources that were based on them: see [Removing logical sources for removed programs in a transport stream](#), on



page 180.

## Managing Cards in a Kaleido-X, or Kaleido-MX System Representation

### To configure a Kaleido-X, or Kaleido-MX system

- 1 In the main window, click the **System** tab, and then click **Description/Calibrations** on the second-level tab bar.

The main pane displays the System hierarchical list, and the **Tools** pane displays the equipment library when the root of the System list is selected.

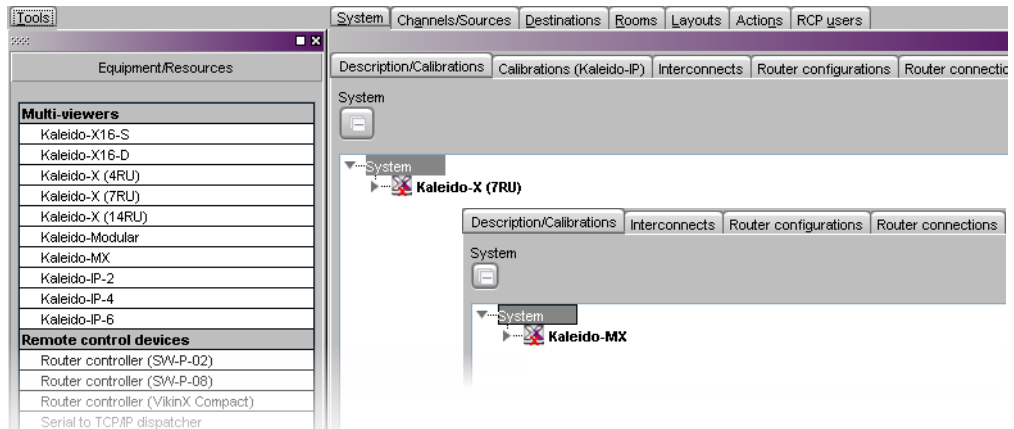

- 2 Expand the **System** root, and the multiviewer you wish to configure.

**Note:** In the case of a Kaleido-X (14RU) expansion system, then you need to first expand the dual frame element, under which both frames A and B are listed. You can then configure each of the two frames as described below.

The card slots appear in the hierarchical list.

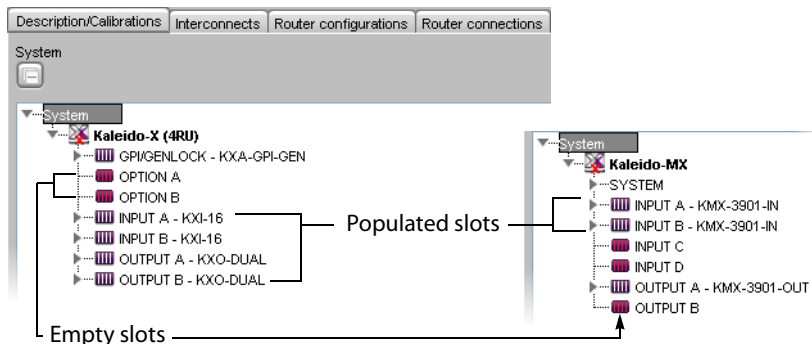

If you used the XEdit factory default configuration or the sample database for your multiviewer model (see [Restoring Factory Defaults](#), on page 111), then the appropriate slots may already be populated with cards.

- 3 Add or remove cards until the system's card slots are populated with cards that match the hardware configuration of your multiviewer. See [Emptying card slots](#), below, and [Populating card slots](#), on page 110, for details.

- 4 On the **File** menu, click **Save**.

Your new system configuration is saved.

## Emptying card slots

To empty card slots in a Kaleido-X, or Kaleido-MX system representation

- 1 In the System list, right-click the populated slot you wish to empty.
- 2 If you wish to empty multiple slots in a single operation, extend your selection by using the standard Shift+click or Ctrl+click keyboard shortcuts. In this case, XEdit will prompt you to confirm your intention.
- 3 Right-click your selection and then click **Remove** on the menu.

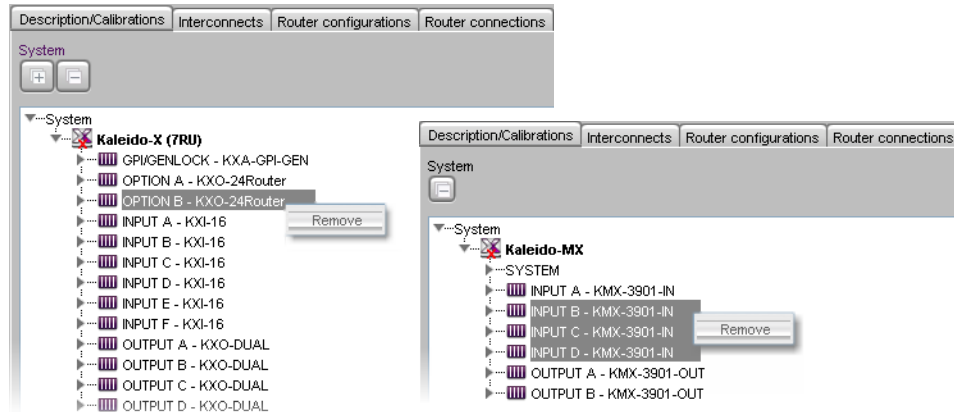

Alternatively click the populated card slot, and then press Delete on your keyboard.

**Note:** Pressing Delete to empty card slots is only supported in the case of a single-card selection.

The slots are now empty and the card type does not appear any more next to the slot name.

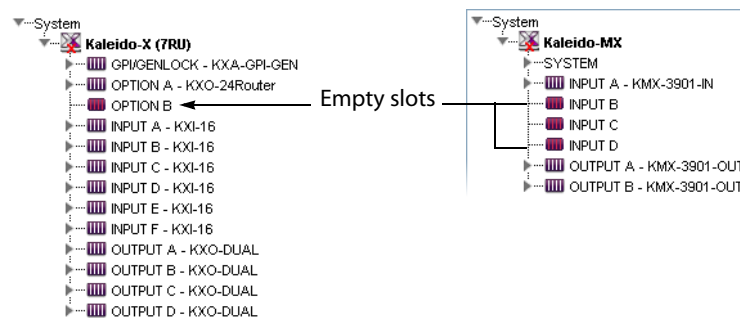

## Populating card slots

To populate slots with cards in a Kaleido-X, or Kaleido-MX system representation

- 1 In the System list, right-click the slot you wish to populate.
- 2 If you wish to populate multiple slots in a single operation, extend your selection to other slots of the same type by using the standard Shift+click or Ctrl+click keyboard shortcuts. In this case, XEdit will prompt you to confirm your intention.
- 3 Right-click your selection and then click **Insert [card type]** on the menu.

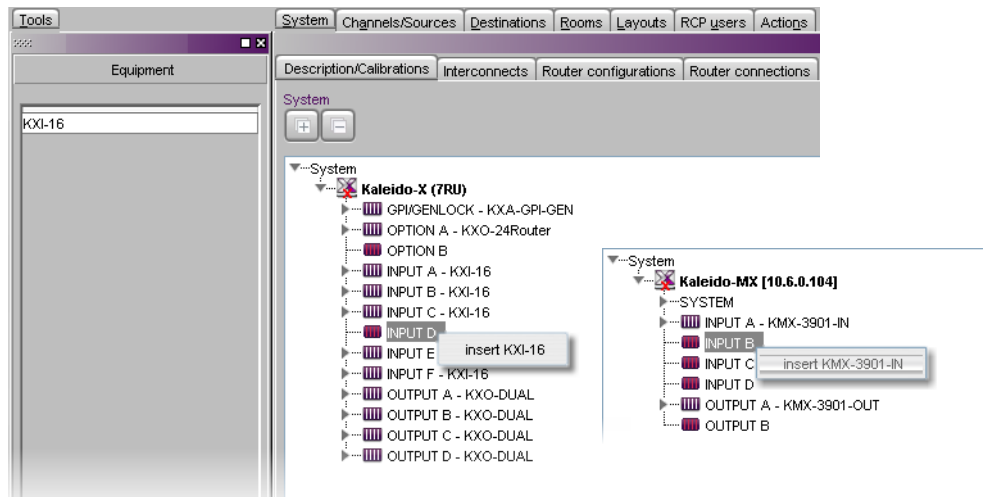

Alternatively drag the card from the equipment library onto the empty card slot.

**Note:** Dragging a card from the equipment library is only supported in the case of a single-card selection.

The slot name is now appended with the card type. For example: *INPUT D - KXI-16*, or *INPUT B - KMX-3901-IN*.

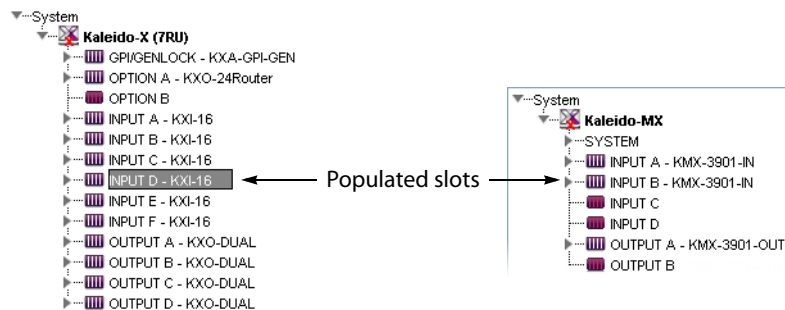

## Restoring Factory Defaults

A number of predefined rooms and layouts are available on the multiviewer itself when you first receive your system. However, if you start configuring a system in XEdit by using the default database XEdit creates for the multiviewer model you selected, you will need to create your own rooms and layouts. The default XEdit-created databases have a number of pre-populated cards and logical sources, as well as one predefined RCP user ("Admin"), but they do not include rooms or layouts. See [Restoring the XEdit Factory Defaults for a Multiviewer](#) on page 112.

Sample factory-default databases with rooms and layouts are available on the DVD that shipped with your system, and from Grass Valley's support portal. If you wish to use default rooms and layouts as a starting point for building your system, you can either import the factory-default database from the multiviewer (see [Restoring Factory Defaults from a Specific Multiviewer](#), on page 114), or use XEdit's **Restore backup** function to load the appropriate database from the DVD, or from the support portal (see [Restoring Factory Defaults from the Kaleido-X DVD](#), on page 114).

In some situations you may wish to repurpose an existing XEdit database that was designed for a specific multiviewer and use it with a different multiviewer model. After the database is converted, it may still include calibrations that were only relevant to the original multiviewer model. This is not desirable if the new system has limited memory compared to the original one. In such a case, restoring the factory-default calibrations and then calibrating your new system as required is faster than recreating rooms and layouts.

## Restoring the XEdit Factory Defaults for a Multiviewer

### IMPORTANT

If you already have rooms or layouts that you wish to keep, make sure to back up the XEdit database before restoring the factory defaults. The XEdit factory defaults do not include any rooms or layouts.

### To restore the XEdit factory defaults for a multiviewer model

- 1 Right-click the current multiviewer in the System list, and then select the appropriate multiviewer model—**Kaleido-X16-S**, **Kaleido-X16-D**, **Kaleido-X (4RU)**, **Kaleido-X (7RU)**, **Kaleido-X (14RU)**, **Kaleido-Modular**, **Kaleido-MX**, **Kaleido-IP-2**, **Kaleido-IP-4** or **Kaleido-IP-6**—, from the “replace with...” options on the menu.

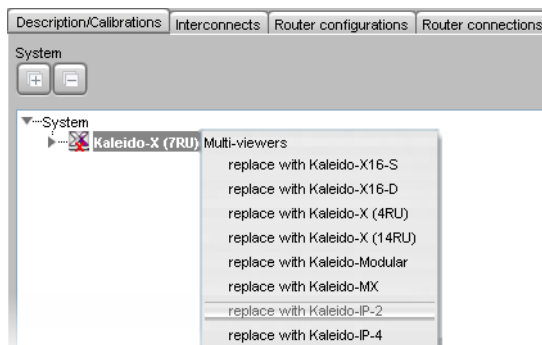

### Note:

If you are working in online mode, the set of multiviewer models available from the menu varies according to the current model. If the current model is a Kaleido-IP, then only the other Kaleido-IP models are available for selection.

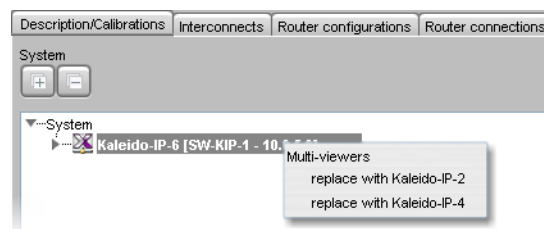

Note: (continued)

Conversely, if the current model is *not a Kaleido-IP*, then *none* of the Kaleido-IP models are available for selection.

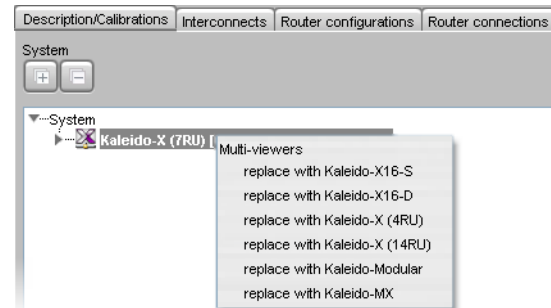

Select...	To represent a...
Kaleido-X16-S	Kaleido-X16 (single output)
Kaleido-X16-D	Kaleido-X16 (dual output)
Kaleido-X (4RU)	Kaleido-X (4RU)
Kaleido-X (7RU)	Kaleido-X (7RU)
Kaleido-X (14RU)	Two Kaleido-X (7RU) frames, with expansion cards
Kaleido-Modular	Any KMV-3901/3911, Kaleido-XQUAD, or Kaleido-XQUAD-DUAL
Kaleido-MX	Any Kaleido-MX, or Kaleido-Modular-X
Kaleido-IP-2	Kaleido-IP X300, or X100 with two network adapters
Kaleido-IP-4	Kaleido-IP X110, X310, or X300 with four network adapters
Kaleido-IP-6	Kaleido-IP X310, or X300 with six network adapters

A message appears, prompting you to confirm your intention.

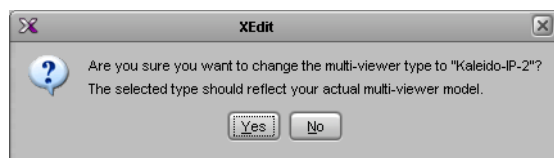

2 Click **Yes**.

XEdit then prompts you to confirm that you want to restore the factory defaults for the multiviewer model you chose.

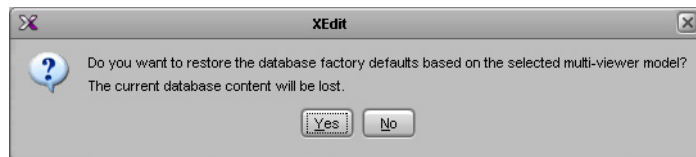

3 Click **Yes**.

The selected multiviewer model appears in the System hierarchical list.

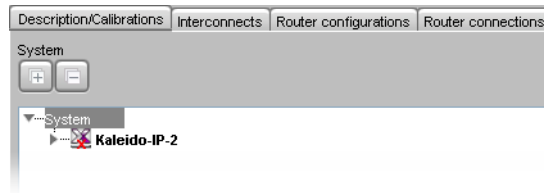

- 4 On the **File** menu, click **Save**.

## Restoring Factory Defaults from a Specific Multiviewer

---

Note: See [Importing a Database](#) on page 79, for details.

---

### To restore factory defaults from a multiviewer

- 1 On the **Configure** menu, point to **Database**, and then click **Import**.

A window appears, prompting you for the IP address of the multiviewer whose factory-default database you wish to import.

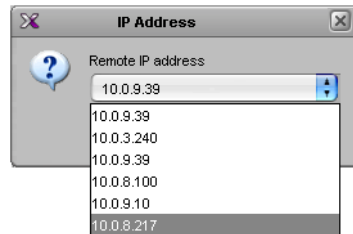

IP addresses for all the multiviewers that are on the same subnet as your PC are included in the list.

- 2 If your PC and the multiviewer are on the same subnet, then you can select the IP address of the multiviewer from the list. Otherwise type the appropriate IP address in the box.

A window appears, prompting you to confirm that you really want to import data from the multiviewer.

- 3 Click **Yes**.

A progress window appears, followed by a message stating whether the import succeeded or not.

- 4 Click **OK**.

## Restoring Factory Defaults from the Kaleido-X DVD

---

### Notes

- The factory default databases are also available from the *Software and documentation* section of Grass Valley's support portal.
  - See [Restoring a Backup](#) on page 84, for more information on restoring a database.
- 

### To restore factory defaults from the Kaleido-X DVD

- 1 On the **Configure** menu, point to **Database**, and then click **Restore backup**.

The **Restore backup** window appears.

- 2 In **Restore backup**, navigate to the Kaleido-X DVD, locate the appropriate default database for your multiviewer model—for instance, *Kaleido-X (7RU).zip*, if you have a Kaleido-X (7RU)—, select it, and then click **Open**.

A message appears prompting you to confirm your intention.

- 3 Click **Yes**.

### Factory Defaults by Multiviewer Model

Model	Database	Logical sources	Rooms	Layouts	RCP users
Kaleido-IP-2	Kaleido-IP-2.zip	8	1	5	1 (Admin)
Kaleido-IP-4	Kaleido-IP-4.zip	8	1	5	1 (Admin)
Kaleido-IP-6	Kaleido-IP-6.zip	8	1	5	1 (Admin)
KMV-3901/3911 8×2, Kaleido-XQUAD-DUAL	Kaleido-Modular-8X2_16_9_Displays.zip, Kaleido-Modular-8X2_16_10_Displays.zip	8	1	30	1 (Admin)
KMV-3901/3911 8×1	Kaleido-Modular-8X1_16_9_Display.zip	8	1	22	1 (Admin)
KMV-3911 4×2	Kaleido-Modular-4X2_16_9_Displays.zip	4	1	22	1 (Admin)
KMV-3911 4×1, Kaleido-XQUAD	Kaleido-Modular-4X1_16_9_Display.zip	4	1	22	1 (Admin)
Kaleido-MX 8×1, Kaleido-Modular-X 8×1	Kaleido-MX-8x1.zip	8	1	8	1 (Admin)
Kaleido-MX 8×2, Kaleido-Modular-X 8×2	Kaleido-MX-8x2.zip	8	1	9	1 (Admin)
Kaleido-MX 16×1, Kaleido-Modular-X 16×1	Kaleido-MX-16x1.zip	16	1	12	1 (Admin)
Kaleido-MX 16×2, Kaleido-Modular-X 16×2	Kaleido-MX-16x2.zip	16	1	12	1 (Admin)
Kaleido-MX 16×4, Kaleido-Modular-X 16×4	Kaleido-MX-16x4.zip	16	1	12	1 (Admin)
Kaleido-MX 24×1, Kaleido-Modular-X 24×1	Kaleido-MX-24x1.zip	24	1	13	1 (Admin)
Kaleido-MX 24×2, Kaleido-Modular-X 24×2	Kaleido-MX-24x2.zip	24	1	12	1 (Admin)
Kaleido-MX 32×2, Kaleido-Modular-X 32×2	Kaleido-MX-32x2.zip	32	1	12	1 (Admin)
Kaleido-MX 32×4, Kaleido-Modular-X 32×4	Kaleido-MX-32x4.zip	32	1	12	1 (Admin)
Kaleido-MX 48×2, Kaleido-Modular-X 48×2	Kaleido-MX-48x2.zip	48	1	13	1 (Admin)

**Factory Defaults by Multiviewer Model (continued)**

Model	Database	Logical sources	Rooms	Layouts	RCP users
Kaleido-MX 48×4, Kaleido-Modular-X 48×4	Kaleido-MX-48x4.zip	48	1	12	1 (Admin)
Kaleido-MX 64×2, Kaleido-Modular-X 64×2	Kaleido-MX-64x2.zip	64	1	13	1 (Admin)
Kaleido-MX 64×4, Kaleido-Modular-X 64×4	Kaleido-MX-64x4.zip	64	1	12	1 (Admin)
Kaleido-X16-S	Kaleido-X16-S.zip	16	1	21	1 (Admin)
Kaleido-X16-D	Kaleido-X16-D.zip	16	1	21	1 (Admin)
Kaleido-X (4RU)	Kaleido-X (4RU).zip	32	2	4	1 (Admin)
Kaleido-X (7RU)	Kaleido-X (7RU).zip	96	4	24	1 (Admin)
Kaleido-X (14RU)	Kaleido-X (14RU).zip	192	6	72	1 (Admin)

**Managing Multiple Databases Efficiently**

To avoid mistakes in managing databases, especially when multiple multiviewers are involved, it is recommended to follow the rules below:

- Back up the database for each system to a central repository, separate from the local workspace you use when working in XEdit offline.
- When using XEdit, limit yourself to a single workspace. When working online, the local workspace is not used. When working offline, first either import the database from the appropriate multiviewer into your XEdit workspace, or restore the latest backup for the system you wish to work on.
- When your work session in XEdit is complete, always create a new backup of the database, regardless of whether you were working online or offline.

The next sections describe three typical situations, summarized below:

<b>Online</b>	<b>Offline</b>	<b>System restore from backup (offline)</b>
1 Work in XEdit. 2 Backup database from multiviewer to central repository.	1 Import database from multiviewer into local workspace. 2 Work in XEdit. 3 Back up database from local workspace to central repository. 4 Export database from local workspace to multiviewer.	1 Restore backup from central repository into local workspace. 2 Work in XEdit, if needed... ...and then back up database from local workspace to central repository. 3 Export database from local workspace to multiviewer.

**Working online**

If you are connected to a multiviewer, and working online in XEdit, you are actually editing the database that is located inside the multiviewer's file system. There is one database per multiviewer. An expansion system, comprising two Kaleido-X (7RU) frames, is also managed



through a single database. A cluster system includes one database for each multiviewer in the cluster, which are backed up or restored as a single operation. When you have completed your changes, create a backup of the current system and store it in a secure location on your PC.

#### To back up the current Kaleido-X system

- 1 On the **Configure** menu, point to **Database**, to **Create backup**, and then click **All**.
- 2 Browse to the secure location on your PC where you store all your database backups (e.g. `MirandaDatabaseBackups`), and type a name for the new backup, preferably a name that includes the multiviewer name and the date (e.g. `KX_A&B_08_12_02.zip`).

#### Working offline

When using XEdit offline, you work inside a workspace located on your client PC. You set the location for this workspace when you first opened XEdit. It is recommended to consider this workspace as a “sandbox” into which you import the database you wish to work on during this session, and from which you export the database at the end of the session.

---

##### TIP

Once you are satisfied with the location of your local workspace, on the **Configure** menu, point to **Database**, and then select the **Do not prompt for the database path** check box, to avoid being prompted every time you open XEdit.

---

See [Importing a Database](#) on page 79, for instructions on how to import the database from a specific multiviewer into your workspace. Once the import is completed, you can work locally, in your XEdit workspace. When you have completed your changes, export the database from the workspace, back to the multiviewer.

#### Applying a backup database to the multiviewer

To restore a backup database, you must use XEdit in offline mode. A backup database must first be restored to your local workspace before it can be exported back to the appropriate multiviewer.

#### To restore a backup database

- 1 On the **Configure** menu, point to **Database**, and then click **Restore backup**.  
A window appears, prompting you to locate a backup database.
- 2 Navigate to your central backup storage area, select the backup database you wish to restore, and then click **Open**.  
A message appears prompting you to confirm your intention.
- 3 Click **Yes**.

Once the operation completes, your XEdit workspace area will contain the restored database. You can now work on this database in offline mode, or export it back to the multiviewer.



# 5 Calibrating the Kaleido-X

A Kaleido-X system includes a number of cards or modules that process a variety of signal types. This section explains how to calibrate features related with the different signal types.

## Key Concepts

### IMPORTANT

#### **Calibration changes are applied immediately.**

Unlike other elements in a multiviewer configuration, system calibrations do not need to be saved.

- When using XEdit in *online* mode, calibration changes become immediately effective.
- When using XEdit in *offline* mode, calibration changes are applied to the system representation in your local workspace.

## Profiles

Profile	With the current version of the Kaleido-X software, profiles are available for Kaleido-IP multiviewers only. A profile is a group of calibrations that you configure for a specific purpose, and then apply to specific elementary streams as needed. A default audio profile, a default video profile, and a default teletext profile are available with set calibrations. You may add custom profiles to your system, and configure them as needed. See <a href="#">Managing Calibration Profiles</a> on page 123.
Video profile	Video profiles include video input calibrations: alarm debouncing, metadata holding time, and presence timeout parameters. See <a href="#">Multiviewer Input Calibrations</a> on page 120.
Audio profile	Audio profiles include audio input calibrations: a zero VU reference level calibration, alarm threshold calibrations, alarm debouncing, and loudness calibrations. See <a href="#">Multiviewer Input Calibrations</a> on page 120.
Teletext profile	Teletext profiles include calibrations for page selection, subtitling holding time, alarm debouncing, and text presence timeout calibration. See <a href="#">Managing Calibration Profiles</a> on page 123.

### Multiviewer Output Calibrations

Brightness	The green, red, and blue brightness parameters determine the black level of the RGB output signals shown on the corresponding display. See <a href="#">Calibrating the Brightness and Contrast</a> on page 125. Available for Kaleido-X, and Kaleido-X16 only.
Contrast	The green, red, and blue contrast parameters determine the white level of the RGB output signals shown on the corresponding display. See <a href="#">Calibrating the Brightness and Contrast</a> on page 125. Available for Kaleido-X, and Kaleido-X16 only.
Color saturation	The color saturation of an RGB output signal can be adjusted so that colors in the video windows will match the surrounding graphical elements on the corresponding display. See <a href="#">Calibrating Color Saturation</a> on page 126. Available for Kaleido-X, and Kaleido-X16 only.
DVI keying mode	Kaleido-X and Kaleido-X16 multiviewers have a DVI input connector for every output head. Using these connectors, it is possible to feed keying material to the multiviewer. Depending on your purposes, the content provided through the DVI input can be set either as a background or as a foreground for the layout shown on the monitor wall. See <a href="#">Calibrating the DVI Keying Mode</a> on page 128, and <a href="#">Setting up a Layout for Background Keying from the DVI Input</a> , on page 234.
Audio monitoring delay	Each of the output heads in a Kaleido-X, or Kaleido-X16 multiviewer is associated with two audio output channels. The monitoring output is simultaneously available on one AES and two analog connections. For each head, output parameters can be adjusted to optimize the relative timing of the audio and video signals on the monitor wall display. The <b>Audio monitoring delay</b> calibration provides this function. See <a href="#">Calibrating the Audio Monitoring Delay</a> on page 129. Available for Kaleido-X, and Kaleido-X16 only.
Audio monitoring color	Audio monitors can have an indicator that changes color depending on the output display where audio monitoring of the associated audio level is taking place. The default color is a shade of blue. See <a href="#">Calibrating the Audio Monitoring Color</a> on page 130.

### Multiviewer Input Calibrations

Detail enhancer	The purpose of the detail enhancer parameter is to recover sharpness that may have been lost in the de-interlacing and scaling process. See <a href="#">Calibrating Detail Enhancement and Dynamic Range</a> on page 142. Available for Kaleido-MX, Kaleido-Modular-X, Kaleido-X, and Kaleido-X16 only.
Dynamic range	The dynamic range parameter determines the color model to be applied: either full-range RGB (0-255) or video RGB (16-235). Full-range RGB is also called <i>computer RGB</i> ; video RGB is also called <i>studio RGB</i> . See <a href="#">Calibrating Detail Enhancement and Dynamic Range</a> on page 142. Available for Kaleido-MX, Kaleido-Modular-X, Kaleido-X, and Kaleido-X16 only.

### Multiviewer Input Calibrations (*continued*)

Aspect ratio	<p>Unlike <i>HD</i> signals where aspect ratio information, when available, always follows the SMPTE 2016 standard, there are different standards for encoding aspect ratio information in <i>SD</i> signals. The AFD &amp; WSS calibrations determine which standard will be applied by default to <i>SD</i> signals feeding the selected multiviewer input. The aspect ratio of video windows on the monitor wall can then be automatically adjusted, based on the current source assignment. See <a href="#">Calibrating Aspect Ratio Decoding</a> on page 141.</p> <p>Note: In the case of the Kaleido-IP, aspect ratio information can be extracted and monitored. No calibration is needed for the Kaleido-IP, since it supports decoding of a signal's aspect ratio from AFD metadata only. However, the Kaleido-X software does not yet support automatic aspect ratio adjustment <i>based on the decoded information</i> for signals originating from these multiviewers.</p>
NTSC standard	<p>The NTSC and NTSC-J standards are different with regard to their black level. This parameter determines which standard is to be applied to the selected analog input signal. Available for Kaleido-X, and Kaleido-X16 only.</p>
Subtitling/closed captioning	<p>Presence alarms can be configured against up to four—up to eight, in the case of a Kaleido-IP—preset Teletext (WST) subtitle pages for each input signal. The subtitling page selection parameters determine which pages will be monitored. In the case of the Kaleido-MX, Kaleido-Modular-X, Kaleido-X, and Kaleido-X16 multiviewers, the teletext page set as <i>page A</i> will also be decoded, and its content can be displayed in a video window. In the case of a Kaleido-IP, all eight teletext pages (page A to page H) can be decoded. Requires the CC/XDS option (see <a href="#">Hardware and Software Options</a>, on page 443). There are also subtitling calibrations for the CEA-608 CC and the DTVCC alarms. See <a href="#">Calibrating Subtitling/Closed Captioning</a> on page 143.</p>
Metadata holding time	<p>The holding time parameters determine the delay after which decoded metadata such as closed captions, teletext subtitles, or XDS metadata will be cleared. Requires the CC/XDS option (see <a href="#">Hardware and Software Options</a>, on page 443). Refer to <a href="#">Calibrating Metadata Holding Time</a>, on page 145 for details.</p>
Zero VU (dBu)	<p>The Zero VU (dBu) parameters determine the reference level to be applied to the selected analog input signal, from an Audio Bridge Terminal (ABT). Its default value is 4 dBu, on a range of -24 dBu to 8 dBu. See <a href="#">Calibrating Zero VU Reference Level for an ABT Audio Source</a> on page 140.</p>
Zero VU (dBFS)	<p>The Zero VU (dBFS) parameters determine the reference level to be applied to the selected digital (embedded, or from ABT) audio signal. dBFS stands for <i>decibels full scale</i>. Zero dBFS corresponds to the maximum possible level. By default the reference level for a it is set to -20 dBFS, on a range of -24 dBFS to -8 dBFS. The extraction of digital audio requires the KXS-HD-EMB or KXS-SD-EMB option (see <a href="#">Hardware and Software Options</a>, on page 443). Refer to <a href="#">Calibrating Zero VU Reference Levels for Embedded Audio Sources</a>, on page 139 for details.</p>

### Multiviewer Input Calibrations (*continued*)

Audio program	<p>In the case of Kaleido-X16 and Kaleido-X with <i>second-generation</i> input cards (KXI-16SV rev. 600 and later, KXI-16HS3, and KXI-16HSV3), you can define up to two groups of audio channels, for each video input—each group, itself, constituting an audio program. Loudness measurement is based on audio program calibrations for these multiviewer models. See <a href="#">Configuring Audio Programs</a> on page 132.</p>
Audio loudness	<p>A measure of the perceived loudness of a group of audio channels (an <i>audio program</i>). Various measurement modes are available depending on the hardware being used. It is possible to configure an alarm that will be triggered when the measured loudness deviates too far from a target specified either by a standard or by your organization.</p> <p>An alarm can also be triggered when the measured loudness deviates too far from the dialnorm value found in the VANC audio metadata (SMPTE 2020).</p> <p>Depending on the hardware, the loudness measurement mode will either be:</p> <ul style="list-style-type: none"> <li>• Compliant with recommendations from Dolby regarding dialog loudness measurement (ATSC A/53) and provide a short term value referred to as <i>loudness</i>, with a limit of one measurement per video channel. This applies to Kaleido-X with <i>first-generation</i> input cards (KXI-16SV rev. 599 and earlier, KXI-16HS, and KXI-16HSV), only. See <a href="#">Calibrating Dolby Dialog Loudness Measurement</a> on page 136.</li> </ul> <p><b>OR,</b></p> <ul style="list-style-type: none"> <li>• Based on recent standards (EBU R128, ATSC A/85, ARIB TR-B32) and provide two measures (short term, and momentary) per audio program. This applies to Kaleido-IP, Kaleido-X16, and Kaleido-X with <i>second-generation</i> input cards (KXI-16SV rev. 600 and later, KXI-16HS3, and KXI-16HSV3). See <a href="#">Calibrating Loudness Measurement</a> on page 133. For the Kaleido-X and Kaleido-X16, although two audio programs can be defined per video input, there is a limitation on the number of concurrent measurements that can be made. See <a href="#">Calibrating Loudness Probe Assignments</a> on page 135.</li> </ul>
Dolby E selection	<p>In the case of the Kaleido-X, and Kaleido-X16 multiviewers, Dolby E audio can be decoded from two of eight AES pairs within a signal's embedded audio stream. The Dolby E selection parameters determine which AES pairs will be used. See <a href="#">Configuring Sources for Dolby E Audio Metadata</a>, on page 138 for details.</p> <p>Notes</p> <ul style="list-style-type: none"> <li>• Dolby E decoding requires the Dolby E option. In the case of a Kaleido-MX, Kaleido-Modular-X, or Kaleido-X multiviewer model, one license is needed per input card. See <a href="#">Enabling Options</a> on page 471.</li> <li>• Kaleido-MX, and Kaleido-Modular-X support decoding of Dolby E metadata from all eight embedded pairs within a video source.</li> <li>• Dolby E decoding is not supported on the Audio Bridge Terminal (ABT).</li> </ul>

### Router Output Calibrations

Switch field selection	The switch field parameter determines whether the router module will perform clean crosspoint changes on the odd (field 1) on the even (field 2) field, or on any field. See <a href="#">Calibrating Switch Field Selection</a> on page 148. Available for Kaleido-X16, Kaleido-X (7RU), and Kaleido-X (14RU) expansion systems only.
SDI output reclocking	The SDI output reclocking parameter determine whether digital video signals will have their timing restored at the selected output, to eliminate jitter. Reclocking is typically used in installations with large routing devices or long cables in the signal path. See <a href="#">Calibrating SDI Signal Reclocking</a> on page 149. Available for Kaleido-X16, Kaleido-X (7RU), and Kaleido-X (14RU) expansion systems only.

### GPI/Genlock Calibrations

GPI line direction	On Kaleido-X systems with a GPI/genlock module, GPI lines can be configured as inputs or outputs. On the Kaleido-X16 and KMV-3901/3911 multiviewer models, the GPI lines are unidirectional (4 out and 32 in for the Kaleido-X16, 2 out and 8 in for the KMV-3901/3911). In all cases, the state of any GPI output can be set manually for test purposes, by using their ON/OFF calibration. See <a href="#">GPI/Genlock Calibrations</a> on page 150.
--------------------	--

## Detailed Directions

### Managing Calibration Profiles

#### Creating Calibration Profiles

##### To create a calibration profile

- 1 In XEdit's main window, click the **System** tab, and then click **Calibrations (Kaleido-IP)** on the second-level tab bar.
- 2 On the **File** menu, click **Add audio profile**, **Add video profile**, or **Add teletext profile** depending on the type of calibration profile you wish to create.  
The new profile appears in the **Tools** pane.
- 3 Click the profile to rename it as desired.

#### Deleting Calibration Profiles

##### To delete a calibration profile

- 1 In XEdit's main window, click the **System** tab, and then click **Calibrations (Kaleido-IP)** on the second-level tab bar.
- 2 In the **Tools** pane, click the profile you wish to delete.
- 3 On the **File** menu, click **Delete profile**.

## Configuring Calibration Profiles

### To configure a calibration profile

- 1 In XEdit's main window, click the **System** tab, and then click **Calibrations (Kaleido-IP)** on the second-level tab bar.
- 2 In the **Tools** pane, click the profile you wish to configure.  
A hierarchical list representing all applicable calibrations appears in the main window.
- 3 Navigate to the element you wish to calibrate, and select it.

The related attributes appear in the **Properties** pane.

- See [Configuring Alarm Debouncing](#) on page 162, if you need to change debouncing parameters for teletext, audio, or video alarms, and [Configuring Alarm Thresholds](#), on page 159, to adjust alarm thresholds.
  - For an audio profile:
    - Refer to [Audio Calibrations](#), on page 161, if you need to change audio alarm thresholds.
    - See [Calibrating Loudness Measurement](#) on page 133, for detailed instructions on calibrating loudness measurement.
    - See [Calibrating Zero VU Reference Levels for Embedded Audio Sources](#) on page 139, if you need to change the Zero Vu reference level for all sources associated with the current profile.
  - For a video profile:
    - See [Calibrating Metadata Holding Time](#) on page 145, if you need to change the holding time for XDS metadata, CC or DTVCC captions.
    - Refer to [Metadata Calibration](#), on page 162, if you need to change the presence timeout value for DTVCC services and text.
  - For a teletext profile:
    - See [Calibrating Metadata Holding Time](#) on page 145, if you need to change the holding time for teletext subtitles.
    - See [Calibrating Subtitling/Closed Captioning](#) on page 143, to configure the teletext page selection parameters.
- 4 Repeat [step 3](#) until the profile is properly configured for your purposes.

## Assigning Calibration Profiles

### To assign a calibration profile

- 1 In the main window, click the **System** tab, and then click **Description/Calibrations** on the second-level tab bar. The main pane displays the System hierarchical list.
- 2 Navigate to the elementary stream you wish to calibrate and select it.
- 3 In the **Properties** pane, click **Profile**, and then select the calibration profile you wish to apply to this stream.
- 4 To apply the same profile to all elementary streams of a compatible type (e.g., all audio elementary streams), click **Apply to all**.  
Alternatively, you can drag a profile from the **Tools** pane, onto the desired elementary stream in the System list.



## Multiviewer Output Calibrations

### Calibrating the Brightness and Contrast

**Note:** This section applies to the Kaleido-X and Kaleido-X16 multiviewer models only.

Each of the output heads in the multiviewer can drive a monitor wall display. For each head, output parameters can be adjusted to optimize the image on the monitor wall display: the brightness parameters set the black offsets of the RGB output signals; and the contrast parameters set the gain offsets of these signals.

#### To calibrate the brightness and contrast parameters

- 1 In the main window, click the **System** tab, and then click **Description/Calibrations** on the second-level tab bar.  
A hierarchical list representing the current system appears.
- 2 In the list, expand the multiviewer whose output heads you wish to calibrate.

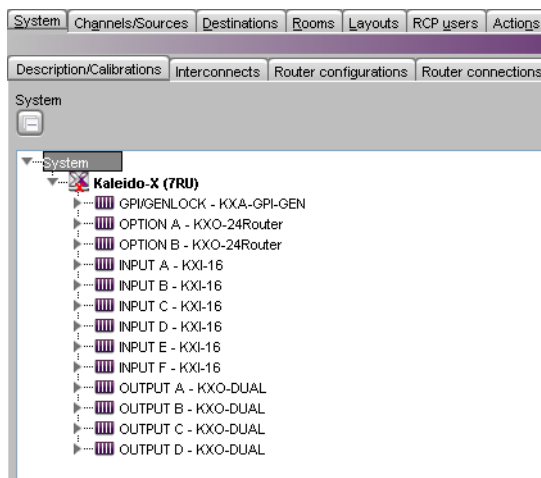

- 3 Expand the appropriate output module.  
The expanded module will show the output heads. (Depending on the multiviewer model, other items may also appear.)

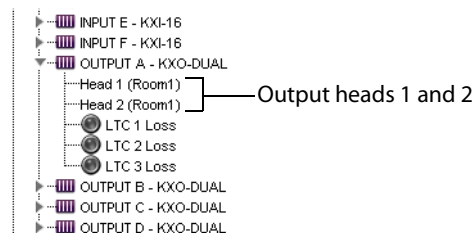

- 4 Select the head you wish to calibrate.  
The brightness and contrast adjustment controls appear in the **Properties** pane.
- 5 Expand the headings to show the controls if they are not visible.

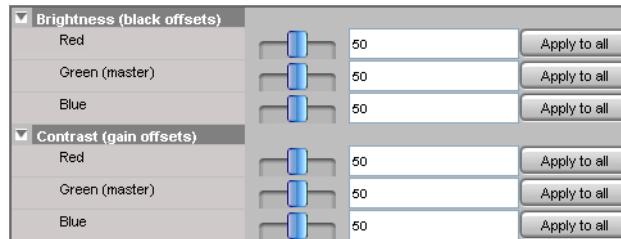

- 6 Use the sliders to adjust the brightness and contrast until you obtain a pleasing presentation of the video elements on the monitor wall display driven by the selected head.

Alternatively, type values directly in the **Red**, **Green (master)**, and **Blue** boxes.

---

**Note:** Moving the **Green (master)** slider will move the **Red** and the **Blue** sliders by the same amount.

The values must be between **0** and **100**.

A good approach is to set all values the same using the **Red** and **Blue** sliders, then to adjust for the best overall presentation using the **Green (master)** slider, and finally to fine-tune the color balance using the **Red** and the **Blue** sliders.

---

- 7 If appropriate, you may copy settings from this head *to every output head in the system*. For each value you wish to apply globally throughout your system, click the corresponding **Apply to all** button.

This has the same effect as selecting every output head one by one, and adjusting the sliders to the same value for the selected parameter.

---

**Note:** If you want to apply the same values to all the other output heads in your system, you must click the **Apply to all** button for **Green (master)** FIRST, and then the **Apply to all** buttons for blue and red in any order. Otherwise the values for blue and red would be modified following the application of the value for green.

---

## Calibrating Color Saturation

---

**Note:** This section applies to the Kaleido-X and Kaleido-X16 multiviewer models only.

---

Each of the output heads in the multiviewer can drive a monitor wall display. The image on the monitor wall contains both graphical elements created by the Kaleido-X system, and video signals that are passed through the system. It is often useful to be able to modify the color saturation of the video so that its appearance within the graphical environment is pleasing. The **Color saturation** calibration control provides this function.

The color saturation calibration does not affect the graphical elements within the monitor wall display.

### To calibrate the color saturation

- 1 In the main window, click the **System** tab, and then click **Description/Calibrations** on the second-level tab bar.

A hierarchical list representing the current system appears.

- In the list, expand the multiviewer whose output heads you wish to calibrate.

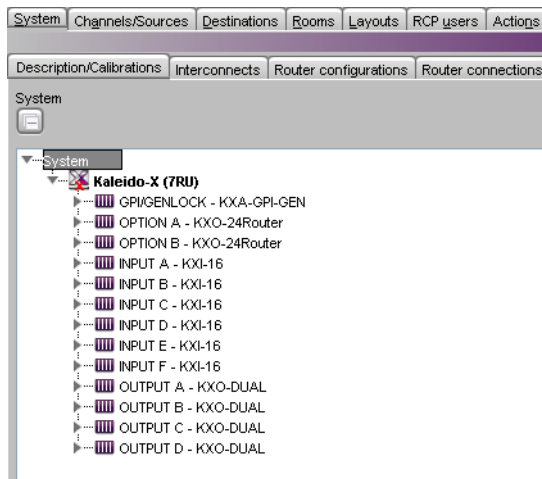

- Expand the appropriate output module.

The expanded module will show the output heads. (Depending on the multiviewer model, other items may also appear.)

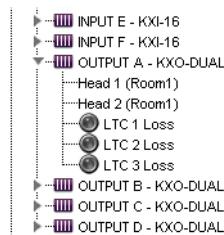

- Select the head you wish to calibrate.

The color saturation adjustment control appears in the **Properties** pane.

- Expand the **Calibration** heading to show the control if it is not visible.

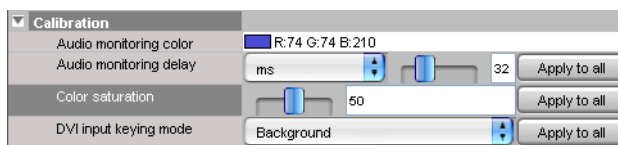

- Use the slider to adjust the color saturation until you obtain a pleasing presentation of the video elements on the monitor wall display driven by the selected head. Alternatively, type a value (between 0 and 100) directly in the **Color saturation** box.

---

**Note:** All videos on the monitor wall display controlled by the selected head are adjusted simultaneously.

---

- If appropriate, you may copy the settings from this head to *every output head* in the system. To apply the color saturation settings globally throughout your system, click **Apply to all**.

This has the same effect as selecting every output head one by one, and adjusting the **Color saturation** slider to the same value.

## Calibrating the DVI Keying Mode

### Notes

- This section applies to the Kaleido-X and Kaleido-X16 multiviewer models only.
- Background keying is enabled by default, and should remain enabled when no actual keying is involved. Enabling the foreground keying mode when there is no signal at the associated DVI input is not supported.
- For more information about using content from the DVI input as background, see [Setting up a Layout for Background Keying from the DVI Input](#), on page 234.

### To calibrate the DVI keying mode

- 1 In the main window, click the **System** tab, and then click **Description/Calibrations** on the second-level tab bar.

A hierarchical list representing the current system appears.

- 2 In the list, expand the multiviewer whose output heads you wish to calibrate.

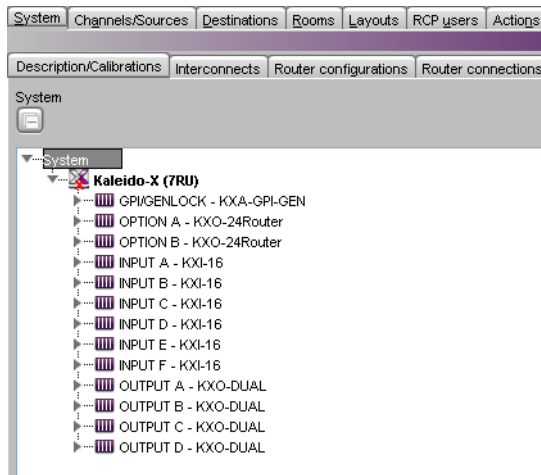

- 3 Expand the appropriate output module.

The expanded module will show the output heads. (Depending on the multiviewer model, other items may also appear.)

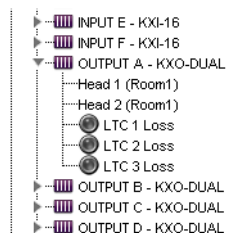

- 4 Select the head you wish to calibrate.
- 5 In the **Properties** pane, select the appropriate value from the **DVI Input Keying Mode** list.

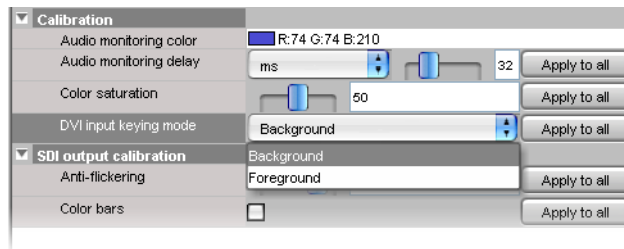

- If appropriate, you may copy the settings from this head to *every output head* in the system: to apply the selected DVI input keying mode globally throughout your system, click **Apply to all**.

This has the same effect as configuring every output head one by one, and selecting the same keying mode for each.

## Calibrating the Audio Monitoring Delay

**Note:** By design, the audio signal is approximately 37 ms ahead of the video.

### To calibrate the audio monitoring delay for a head

- In the main window, click the **System** tab, and then click **Description/Calibrations** on the second-level tab bar. A hierarchical list representing the current system appears.
- In the list, expand the multiviewer whose output heads you wish to calibrate.

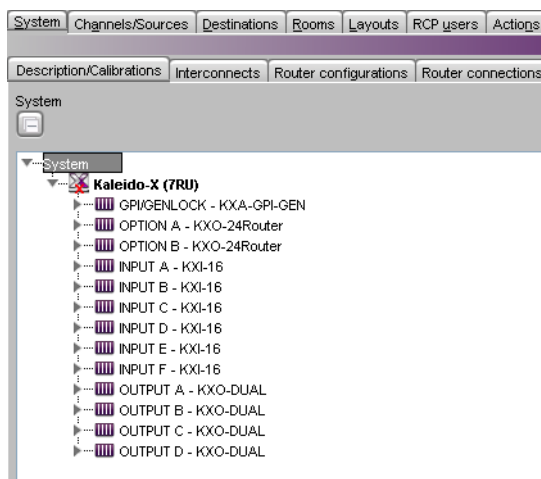

- Expand the appropriate output module. The expanded module will show the output heads. (Depending on the multiviewer model, other items may also appear.)

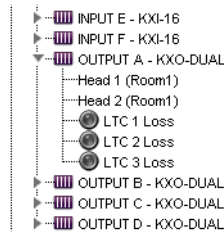

- 4 Select the head you wish to calibrate.

The audio monitoring delay adjustment control appears in the **Properties** pane. Expand the **Calibration** heading to show the control if it is not visible.

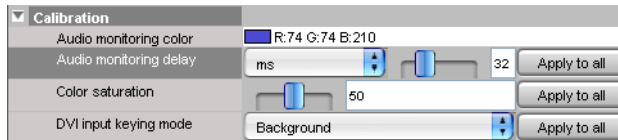

- 5 Select the appropriate unit (milliseconds or AES samples), and then use the slider to adjust the audio monitoring delay until the audio and video are well synchronized on the monitor wall display driven by the selected head.

Alternatively, type a value (between 0 and 100 ms, or between 4 and 4800 AES samples) directly in the **Audio monitoring delay** box.

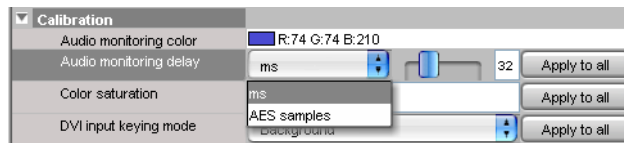

---

**Note:** All videos on the monitor wall display controlled by the selected head are adjusted simultaneously.

---

- 6 If appropriate, you may copy the settings from this head to *every output head* in the system. To apply the audio monitoring delay calibration globally throughout your system, click **Apply to all**.

This has the same effect as selecting every output head one by one, and adjusting the audio monitoring delay settings to the same values.

## Calibrating the Audio Monitoring Color

### To calibrate the audio monitoring color

- 1 In the main window, click the **System** tab, and then click **Description/Calibrations** on the second-level tab bar.

A hierarchical list representing the current system appears.

- 2 In the list, expand the multiviewer whose output heads you wish to calibrate.

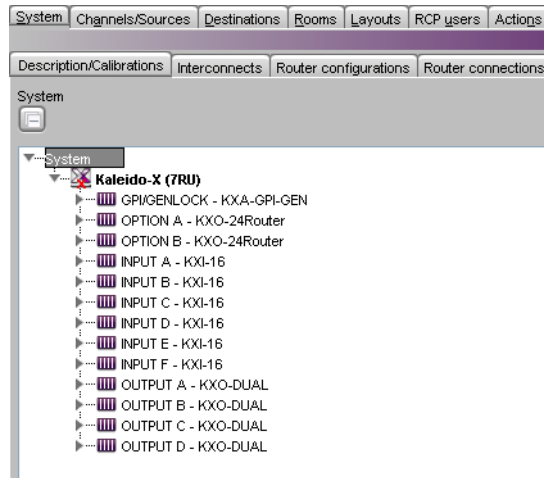

3 Expand the appropriate output module.

The expanded module will show the output heads. (Depending on the multiviewer model, other items may also appear.)

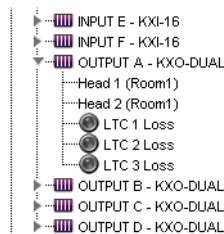

4 Select the head you wish to calibrate.

5 In the **Properties** pane, click the **Audio Monitoring Color** box, and then click the button that appears at the end of the line.

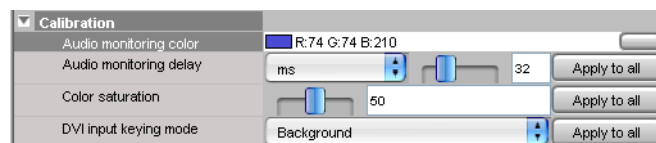

Click to open the color picker window

The color picker window opens.

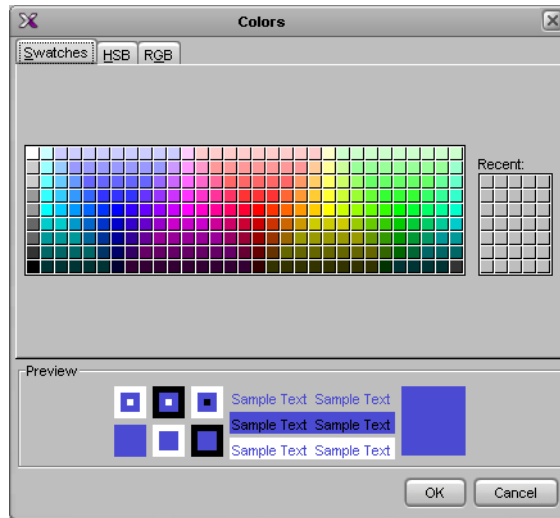

- 6 In **Colors**, click the tab that corresponds to the color space you wish to use, and then choose the color that will be associated with the selected output head.
- 7 Click **OK** to close the color picker window.

## Multiviewer Input Calibrations

To calibrate your multiviewer inputs, you navigate a hierarchical representation of your system in XEdit, and set parameters to match your monitoring purposes.

- In the case of a Kaleido-IP, a default audio profile and a default video profile are available with preset calibrations, which cannot be modified. You may add custom profiles, and configure them as needed, from XEdit's **Calibrations (Kaleido-IP)** tab. You can apply a profile to an elementary stream in the **Description/Calibrations** tab. See [Profiles](#) on page 119.
- For all other multiviewer models, you can modify calibrations for every multiviewer input, from the System list in XEdit's **Description/Calibrations** tab. To apply a specific calibration to all inputs at once, click the corresponding **Apply to all** button.

## Configuring Audio Programs

---

**Note:** This section applies to the Kaleido-X16, and to Kaleido-X multiviewers with *second-generation* input cards (KXI-16SV rev. 600 and later, KXI-16HS3, and KXI-16HSV3), only.

If you have a Kaleido-X with first-generation input cards (KXI-16HSV, KXI-16HS, or KXI-16SV rev. 599 and earlier), see [Calibrating Dolby Dialog Loudness Measurement](#), on page 136.

---

### To configure an audio program

- 1 In the main window, click the **System** tab, and then click **Description/Calibrations** on the second-level tab bar.  
A hierarchical list representing the current system appears.
- 2 In the list, expand the multiviewer whose inputs you wish to calibrate.



- 3 Expand the appropriate input.
- 4 Expand **Audio programs & loudness**, and then click **Program 1**.

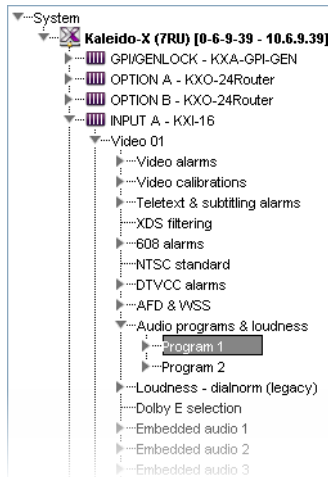

- 5 In the **Properties** pane, select the embedded audio channels that you want to be part of the audio program.

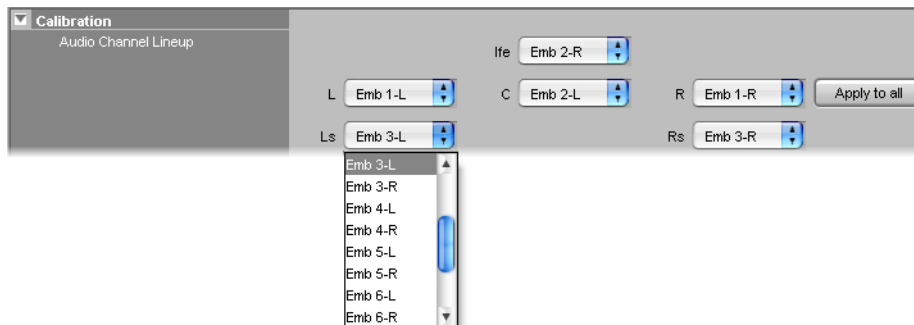

Each channel is assigned a specific role in the program (left, right, center, etc).

- 6 Repeat the procedure to define a second audio program (**Program 2**), if you wish.  
Audio channels can be reused to define the second program or they can be made mutually exclusive as desired.

## Calibrating Loudness Measurement

---

**Note:** This section applies to Kaleido-IP, Kaleido-X16, and Kaleido-X with *second-generation* input cards (KXI-16SV rev. 600 and later, KXI-16HS3, and KXI-16HSV3).

---

### To calibrate loudness measurement

- 1 Navigate to the appropriate input's **Loudness** element in the System list or audio profile, and select it.
  - In the case of a Kaleido-IP, see [Navigating to the loudness calibration in a Kaleido-IP calibration profile](#), on page 134.
  - For a Kaleido-X16 or a Kaleido-X, see [Navigating to the loudness calibration in a Kaleido-X16 or Kaleido-X System list](#), on page 135.

2 In the **Properties** pane, set the appropriate values for your installation.

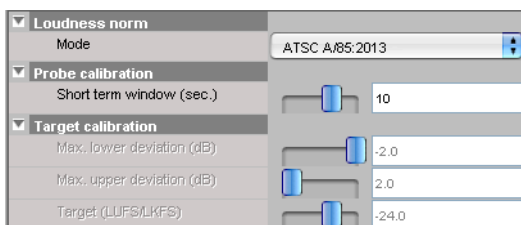

The following values are involved:

Parameter	Description
Mode	Select the loudness standard you wish to apply: EBU R128, ATSC A/85, or ARID TR-B32. Alternatively, you can define a custom mode to gain more control.
Short term window	This parameter determines the integration time of the short term loudness measurement. It is configurable when using ATSC A/85 or a custom measurement mode, with a value on a scale ranging between 1 and 15 seconds.
Max. lower deviation	The <b>Max. lower deviation</b> parameter determines the tolerated excursion range of the short term loudness below the target value. The measured short term loudness and the encoded dialnorm can be compared against each other and against a standard or your organization's target value, and alarms will be triggered in case of too much deviation. In <i>custom</i> mode, possible values range from -70 dB to 0 dB. <sup>1</sup>
Max. upper deviation	The <b>Max. upper deviation</b> parameter determines the tolerated excursion range of the short term loudness above the target value. The measured short term loudness and the encoded dialnorm can be compared against each other and against a standard or your organization's target value, and alarms will be triggered in case of too much deviation. In <i>custom</i> mode, the possible values range from 0 dB to 15 dB.
Target	Type the appropriate loudness value for your custom standard, in the box, or set it using the slider. The default value is -24, on a scale of -70 LUFS/LKFS to 0 LUFS/LKFS. This value can then be compared against the measured loudness, and against the encoded dialnorm found in the Dolby VANC data.

1. Setting this parameter to its lowest value (-70 dB) will prevent the short term/Target alarm from being triggered when silence is detected.

### Navigating to the loudness calibration in a Kaleido-IP calibration profile

#### To navigate to the loudness calibration in a Kaleido-IP calibration profile

- 1 In XEdit's main window, click the **System** tab, and then click **Calibrations (Kaleido-IP)** on the second-level tab bar.
- 2 On the **Tools** tab, select the audio profile whose loudness measurement you would like to calibrate.

A hierarchical list representing all applicable calibrations for this profile appears in the main window.

3 Expand the list, and then click **Loudness**.

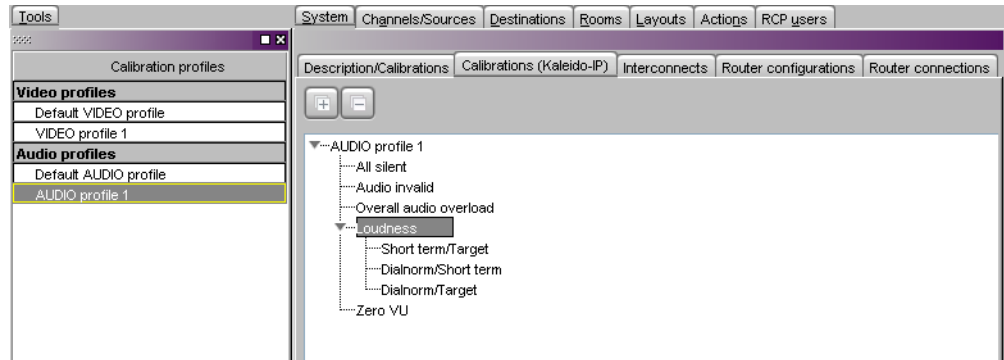

**Navigating to the loudness calibration in a Kaleido-X16 or Kaleido-X System list**

To navigate to the loudness calibration in a Kaleido-X16 or Kaleido-X System list

- a In the main window, click the **System** tab, and then click the **Description/Calibrations** second-level tab.
- b Expand the appropriate input module, then the video input you wish to calibrate, the **Audio programs & loudness** element, the Program element you wish to configure (**Program 1**, or **Program 2**), and then click **Loudness**.

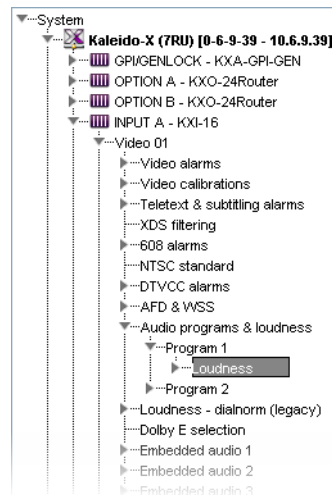

**Calibrating Loudness Probe Assignments**

---

**Note:** This section applies to Kaleido-X16, and Kaleido-X with *second-generation* input cards (KXI-16SV rev. 600 and later, KXI-16HS3, and KXI-16HSV3). In the case of a Kaleido-IP, all audio programs can be measured simultaneously.

---

### To calibrate loudness probe assignments

- 1 In the main window, click the **System** tab, and then click **Description/Calibrations** on the second-level tab bar.  
A hierarchical list representing the current system appears.
- 2 In the list, expand the multiviewer whose inputs you wish to calibrate.
- 3 Expand the appropriate input, and then click **Loudness probe assignment**.

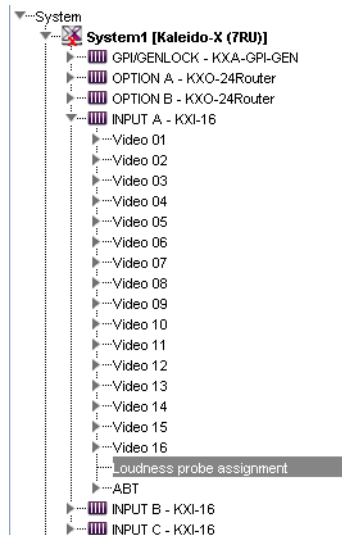

- 4 In the **Properties** pane, assign an audio program to one of the 16 available probes. The default is **Program 1** for all video inputs.

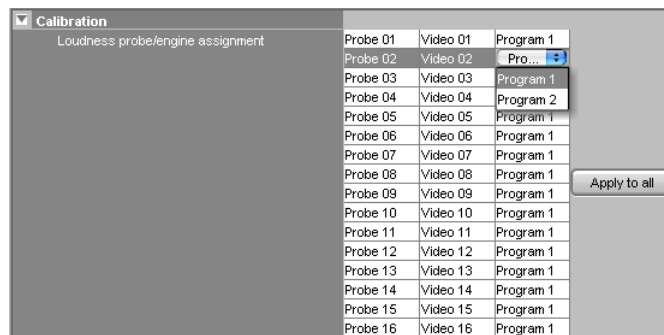

**Note:** If you choose to measure the second program for a specific video input, you will not be able to measure audio programs on all inputs.

### Calibrating Dolby Dialog Loudness Measurement

**Note:** This section applies to Kaleido-X with *first-generation* input cards (KXI-16SV rev. 599 and earlier, KXI-16HS, and KXI-16HSV), only.

If you have a Kaleido-X16, and to Kaleido-X multiviewers with second-generation input cards (KXI-16SV rev. 600 and later, KXI-16HS3, and KXI-16HSV3), see [Configuring Audio Programs](#), on page 132.

### To calibrate loudness measurement for an audio source

- 1 In the main window, click the **System** tab, and then click **Description/Calibrations** on the second-level tab bar.

A hierarchical list representing the current system appears.

- 2 In the list, expand the multiviewer whose inputs you wish to calibrate.
- 3 Expand the appropriate input, and then click **Loudness - dialnorm (legacy)**.

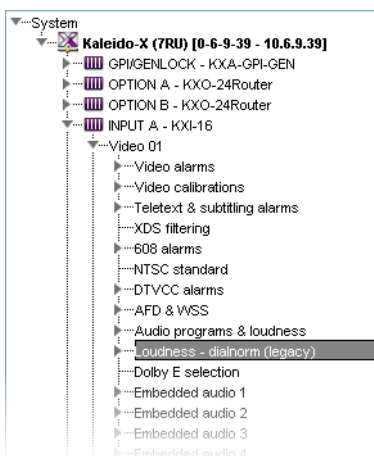

- 4 In the **Properties** pane, set the appropriate values for your installation.

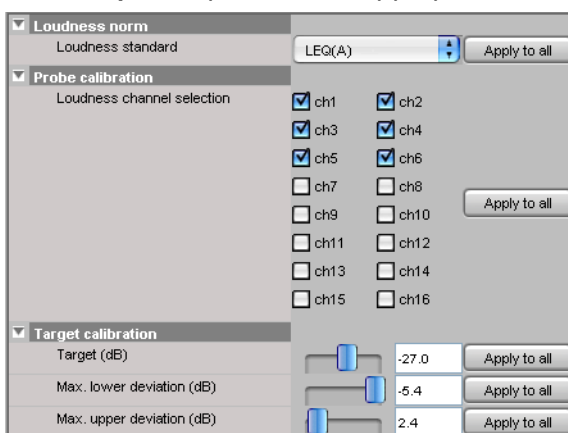

The following values are involved:

Parameter	Description
Loudness standard	Select the standard you wish to apply: either the A-weighted Leq (LEQ(A)) or the ITU-R BS.1770 filter. Note: Mixing standards for different inputs is not supported.
Loudness channel selection	Select the check boxes corresponding to the audio channels that should contribute to the loudness measurement. Note: The Kaleido-X software can measure loudness against a maximum of 8 channels. If you select more than 8 channels, only the first 8 will be used.

Parameter	Description
Target	Type your organization's reference dialnorm value in the box, or set it using the slider. The default value is -27 dB, on a scale of -60 dB to 0 dB. This value can then be compared against the measured loudness, and against the encoded dialnorm found in the Dolby VANC data.
Max. lower deviation	The Max. lower deviation parameter determines the tolerated excursion range below the reference value. The measured levels and the encoded dialnorm can be compared against each other and against your organization's target, and alarms triggered in case of too much deviation. The default value is -5.4 dB, on a scale of -64 dB to 0 dB. <b>Note:</b> Setting this parameter to its lowest value (-64 dB) will prevent the Loudness/Target alarm from being triggered when silence is detected.
Max. upper deviation	The Max. upper deviation parameter determines the tolerated excursion range above the reference value. The measured levels and the encoded dialnorm can be compared against each other and against your organization's target, and alarms triggered in case of too much deviation. The default value is 2.4 dB, on a scale of 0 dB to 15 dB.

## Configuring Sources for Dolby E Audio Metadata

**Note:** This section applies to the Kaleido-X and Kaleido-X16 multiviewer models only.

### To configure sources for Dolby E audio metadata

- 1 In the main window, click the **System** tab, and then click **Description/Calibrations** on the second-level tab bar.  
A hierarchical list representing the current system appears.
- 2 In the list, expand the multiviewer whose inputs you wish to calibrate.
- 3 Expand the appropriate input, and then click **Dolby E selection**.

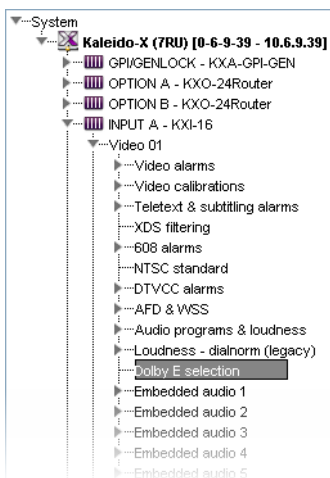

- 4 In the **Properties** pane, select the AES pairs (among **Embedded audio 1** to **Embedded audio 8**) associated with the two Dolby E programs to be decoded, from the two lists: **Dolby E selection 1** and **Dolby E selection 2**.

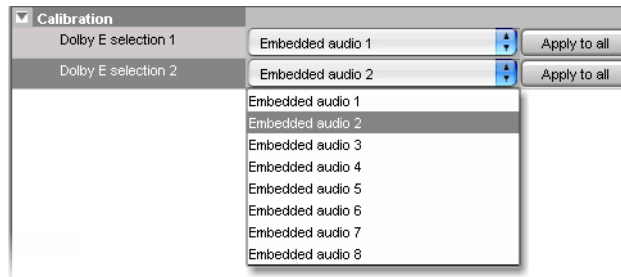

## Calibrating Zero VU Reference Levels for Embedded Audio Sources

### To calibrate a Zero VU reference level

- 1 In the main window, click the **System** tab, and then:
  - In the case of a Kaleido-IP, click the **Calibrations (Kaleido-IP)** tab, select the audio profile you wish to configure, and then click **Zero VU**.

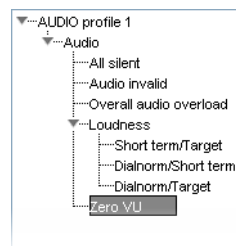

- For all other multiviewer models, click **Description/Calibrations** on the second-level tab bar, expand the appropriate input, then one of its embedded audio elements, and select **Zero VU**.

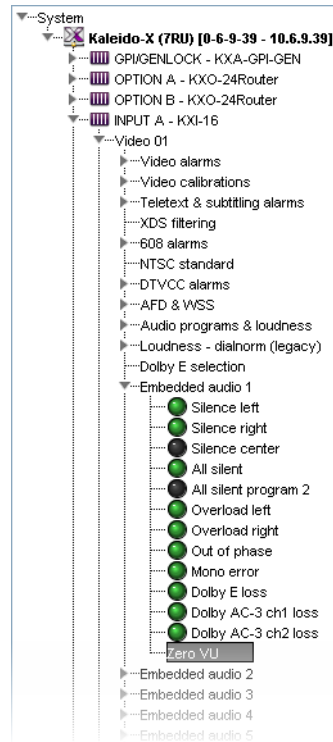

- 2 In the **Properties** pane, set the reference level to the appropriate value (in dBFS), using the **Zero VU** slider, under **Calibration**.

Alternatively, type the value directly in the **Zero VU** box.



## Calibrating Zero VU Reference Level for an ABT Audio Source

---

### Notes

- The KMV-3901/3911 only supports embedded audio, not discrete audio sources from an ABT.
  - This section does not apply to the Kaleido-IP.
- 

### To calibrate an ABT audio source

- 1 In the main window, click the **System** tab, and then click **Description/Calibrations** on the second-level tab bar.  
A hierarchical list representing the current system appears.
- 2 In the list, expand the multiviewer whose inputs you wish to calibrate.
- 3 Expand the appropriate input, its **ABT** element, and then one of the ABT's audio elements. Select **Zero VU**.



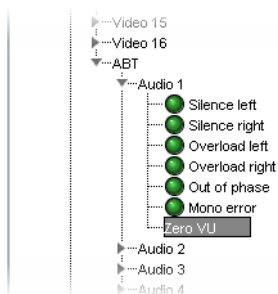

- 4 In the **Properties** pane, set the reference levels to the appropriate values (in dBFS, and in dBu), using the **Zero VU** sliders, under **Calibration**. Alternatively, type the values directly in the **Zero VU** boxes.



## Calibrating Aspect Ratio Decoding

**Note:** This section applies to multiviewers that are used to monitor **SD signals**. In the case of HD signals, since the AFD information always follows AFD 2016, no calibration is needed. No calibration is needed for the Kaleido-IP either, since it supports decoding of a signal's aspect ratio from AFD metadata only. See [page 121](#) for more information.

Aspect ratio information can be encoded following different standards: AFD 2016, AFD VI, or WSS. The following table shows the different standards and their availability according to the signal type:

Signal type	AFD 2016	Video index (AFD VI)	Wide screen signaling (WSS)
HD	Yes	—	—
SD 525	Yes	Yes	—
SD 625	Yes	Yes	Yes

AFD VI information can be encoded as 4 bits or 3 bits (legacy).

### To select the AFD source for an SD signal

- 1 In the main window, click the **System** tab, and then click **Description/Calibrations** on the second-level tab bar.  
A hierarchical list representing the current system appears.
- 2 In the list, expand the multiviewer whose inputs you wish to calibrate.
- 3 Expand the appropriate input, and then click **AFD & WSS**.

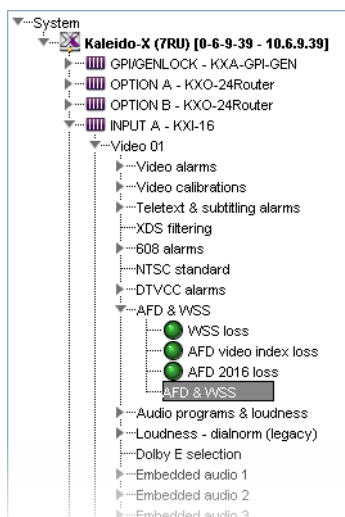

- 4 In the **Properties** pane, select **Legacy AFD 3 bits** to support the legacy AFD 3-bit format for the video index, if appropriate.
- 5 Select the appropriate value from the **SD AFD source** list.

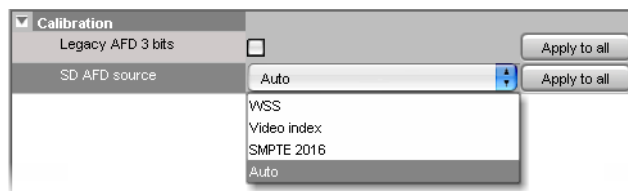

The default value is **Auto**, which means that the multiviewer will automatically detect what is present in the signal and use it to report AFD. If more than one AFD type is present in the signal, and **SD AFD source** is set to **Auto**, then the AFD type is selected in this order: (1) AFD 2016, (2) AFD VI, or (3) WSS.

## Calibrating Detail Enhancement and Dynamic Range

Note: This section applies to the Kaleido-X, Kaleido-X16, Kaleido-MX, and Kaleido-Modular-X multiviewers, only.

### To configure detail enhancement and dynamic range for a video input

- 1 In the main window, click the **System** tab, and then click **Description/Calibrations** on the second-level tab bar.  
A hierarchical list representing the current system appears.
- 2 In the list, expand the multiviewer whose inputs you wish to calibrate.
- 3 Expand the appropriate input, then one of its Video elements.
- 4 Under **Video calibrations**, click **Detail enhancer**.

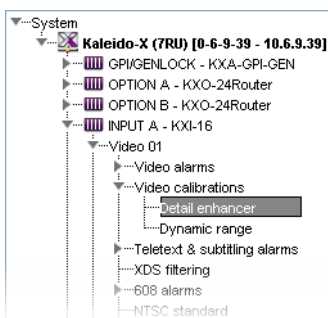

5 In the **Properties** pane, set the appropriate value (between 0 and 15).



6 Click **Apply to all** to apply the associated setting to all video inputs on your multiviewer.

7 In the system list, click **Dynamic range**.

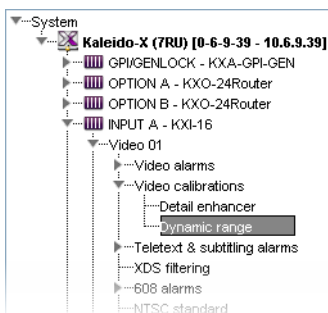

8 In the **Properties** pane, set the appropriate value (either **Full range** or **Video range**).

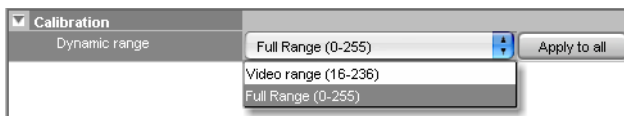

## Calibrating Subtitling/Closed Captioning

This section does *not* apply to the KMV-3901/3911, or Kaleido-XQUAD multiviewers. For a Kaleido-IP, see [Configuring Teletext/Subtitling Page Selection for a Kaleido-IP](#), below. For other multiviewer models, see [Configuring Teletext/Subtitling Page Selection for a Kaleido-X, Kaleido-X16, Kaleido-MX, or Kaleido-Modular-X](#), on page 144.

## Configuring Teletext/Subtitling Page Selection for a Kaleido-IP

To configure Teletext/Subtitling page selection for a Kaleido-IP

- 1 In the main window, click the **System** tab, and then click the **Calibrations (Kaleido-IP)** tab.
- 2 Select the teletext profile you wish to configure, expand the **Page A** element, and then click **Page selection**.

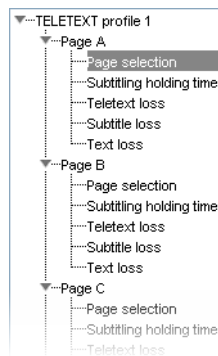

- 3 In the **Properties** pane, type the page number you wish to be the default selection for Page A, in the **Teletext page A selection** box. Alternatively, use the slider to set the page number.



- 4 If you wish to enable or disable teletext decoding for this page, then select or clear the **Enabled** check box accordingly.  
Only decoding of Page A is enabled by default.
- 5 Repeat the procedure for the Page B, to Page H elements.

---

**Note:** Alarms can be configured for all eight preset pages (see [Configuring Alarm Debouncing](#), on page 162 for instructions on how to configure the alarms).

---

### Configuring Teletext/Subtitling Page Selection for a Kaleido-X, Kaleido-X16, Kaleido-MX, or Kaleido-Modular-X

#### To configure Teletext/Subtitling page selection for a Kaleido-X, Kaleido-X16, Kaleido-MX, or Kaleido-Modular-X

- 1 In the main window, click the **System** tab, and then click **Description/Calibrations** on the second-level tab bar.  
A hierarchical list representing the current system appears.
- 2 In the list, expand the multiviewer whose inputs you wish to calibrate.
- 3 Expand the appropriate input, then one of its Video elements.
- 4 Under **Teletext & subtitling alarms**, expand the **Page A** element, and then click **Page selection**.

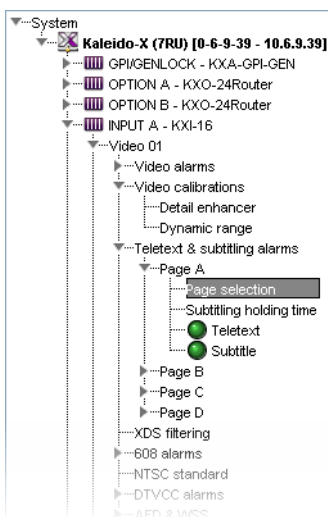

- 5 In the **Properties** pane, type the page number you wish to be the default selection for Page A, in the **Teletext page A selection** box. Alternatively, use the slider to set the page number.



- 6 Click **Apply to all** if you wish this setting to be the default Page A selection for every video signal on your system.
- 7 Repeat the procedure for the Page B, C, and D elements.

---

**Note:** Alarms can be configured for all four preset pages (see [Configuring Alarm Debouncing](#), on page 162 for instructions on how to configure the alarms). The Teletext page set as Page A will also be decoded, and its content can be displayed in a video window.

---

## Calibrating Metadata Holding Time

---

**Note:** This section does *not* apply to the KMV-3901/3911, or Kaleido-XQUAD multiviewers.

---

### To calibrate metadata holding time

- 1 In the main window, click the **System** tab, and then:
  - In the case of a Kaleido-IP, click the **Calibrations (Kaleido-IP)** tab, select the video or teletext profile you wish to configure, and then click **CC Caption holding time**, **XDS filtering**, **DTVCC holding time** (for a video profile), or **Subtitling holding time** (for a teletext profile).

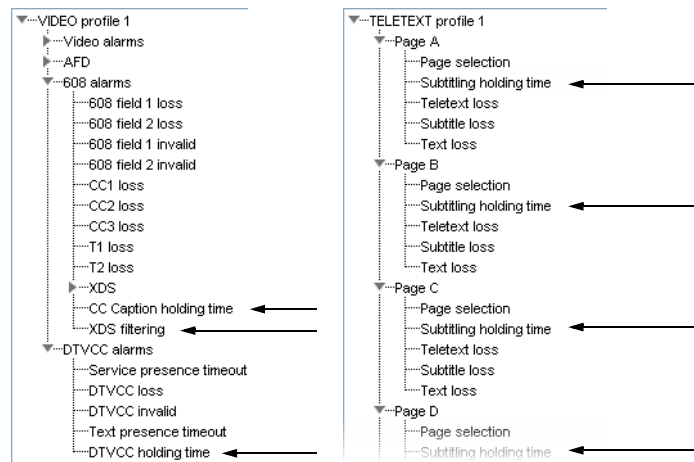

- For all other multiviewer models, click **Description/Calibrations** on the second-level tab bar, expand the appropriate input module, then the video input you wish to calibrate, and select the metadata element whose holding time you wish to configure.

- 2 In the **Properties** pane, set the desired value by typing it directly in the box, or by using the slider (refer to the table below as needed).

### Subtitling holding time

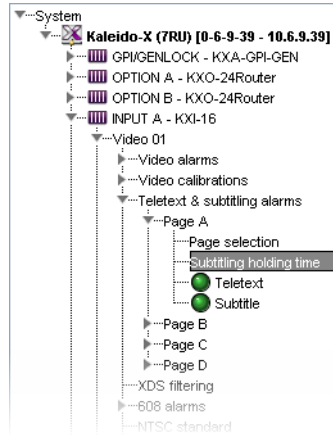

Set the delay (between 5 and 360 seconds, default value is 16 seconds) after which subtitles are cleared:





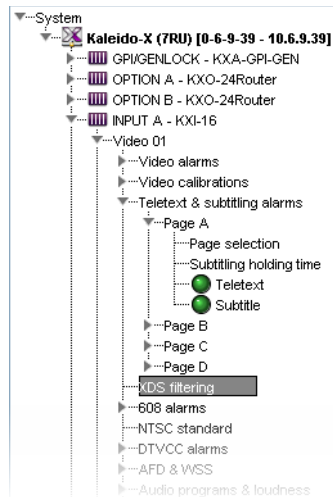

### XDS filtering

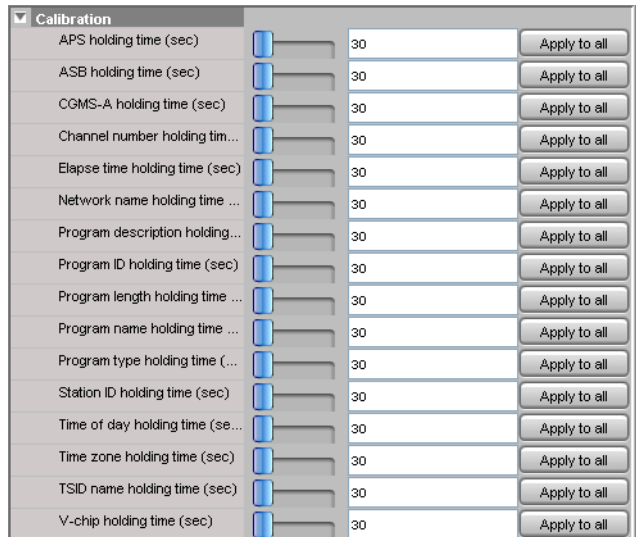

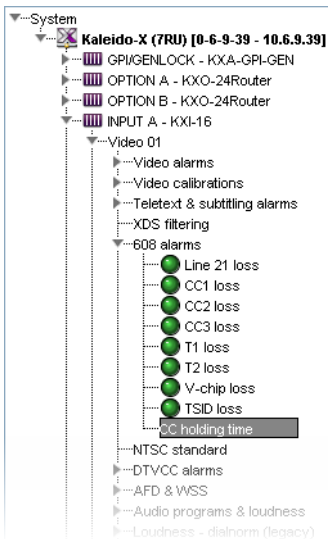
Set the holding time (between 5 and 360 seconds, default value is 30 seconds) for each XDS metadata element (APS, ASB, CGMS-A; channel number; elapsed time; network name; program description, ID, name, length, and type; station ID; TSID name; time of day; time zone; V-chip rating).

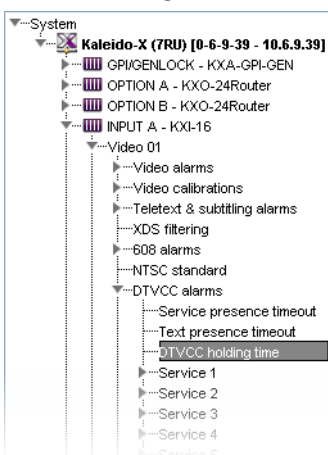

<p><b>CC holding time</b></p> 	<p>Set the delay (between 5 and 360 seconds, default value is 16 seconds) after which closed captions (608) are cleared:</p> 
<p><b>DTVCC holding time</b></p> 	<p>Set the delay (between 15 and 360 seconds, default value is 30 seconds) after which closed captions (708) are cleared:</p> 

## Router Output Calibrations

Note: This section applies to the Kaleido-X16, Kaleido-X (7RU), and Kaleido-X (14RU) expansion systems only.

### Calibrating Switch Field Selection

#### To calibrate switch field selection for a router module

- 1 In the main window, click the **System** tab, and then click **Description/Calibrations** on the second-level tab bar.  
A hierarchical list representing the current system appears.
- 2 In the list, expand the multiviewer you wish to calibrate.
- 3 Expand the appropriate router module, and then click **Switch field selection**.



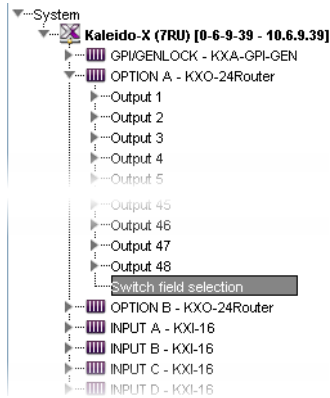

- 4 In the **Properties** pane, click the **Switch field selection** box, and then select the appropriate field value from the list.

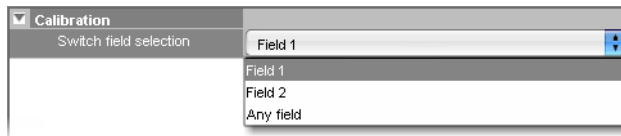

## Calibrating SDI Signal Reclocking

To calibrate reclocking of a router module's output signal

- 1 In the main window, click the **System** tab, and then click **Description/Calibrations** on the second-level tab bar.  
A hierarchical list representing the current system appears.
- 2 In the list, expand the multiviewer you wish to calibrate.
- 3 Expand the appropriate router output, and then click **SDI output reclocking**.

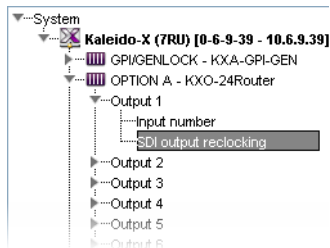

- 4 In the **Properties** pane, click the **SDI output reclocking** box, and then select **ON** or **OFF** from the list.

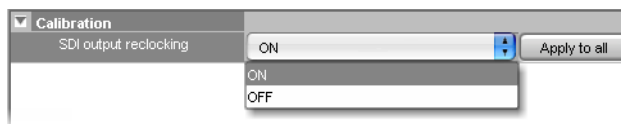

- 5 Click **Apply to all** to apply the chosen value throughout the system.

## GPI/Genlock Calibrations

You can define actions that change the state of a GPI output line, and assign them to a monitor. GPI lines configured as outputs can have their ON/OFF state set manually in XEdit, for test purposes.

---

**Note:** This section applies to Kaleido-X multiviewers, only.

---

### To configure a GPI line's direction as an output

- 1 In the main window, click the **System** tab, and then click **Description/Calibrations** on the second-level tab bar.

A hierarchical list representing the current system appears.

- 2 In the list, expand the multiviewer you wish to calibrate.
- 3 Expand the GPI/GENLOCK module, and then click the desired GPI line element.

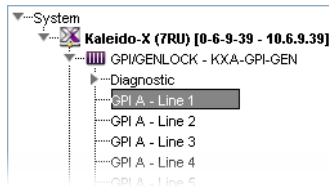

- 4 In the **Properties** pane, click the **GPI direction** box, and then select **output** from the list.

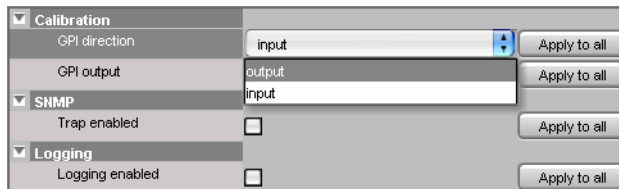

- 5 Click **Apply to all**, if every GPI line in your system is to be configured as an output.
- 6 To set this GPI output line's ON/OFF state set manually for test purposes, click the **GPI output** box, and then select either ON or OFF from the list.

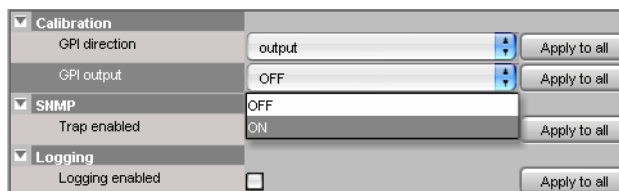

# 6 Configuring Alarms

Your Kaleido-X system can help you monitor alarm conditions efficiently. This section describes how to configure alarm detection and alarm sharing parameters for your system. This configuration is made in XEdit.

## Key Concepts

### Alarm

An alarm is a report on a single, defined condition (generated by a device or service) within a multiviewer system. Depending on how it is configured, an alarm can alert an operator to the occurrence of an event, a change in status, or a specific parameter value (text).

In XEdit, alarms generated by the current multiviewer are displayed in the System list and you can review their status in real time when XEdit is connected to the multiviewer in online mode. You can manage additional alarms, including alarms generated by external devices, by using an alarm browser such as iControl's GSM alarm browser or the alarm browser pane in XEdit's **Build Virtual Alarm** window.

### General Status Manager (GSM)

The general status manager (GSM) is the service responsible for central management of all alarm conditions within a monitoring and control system. Every Kaleido multiviewer has a GSM and can be configured to share GSM information with other multiviewers and iControl systems. For example:

- Display alarm status information from Densité cards on the monitor wall.
- Display alarms detected within a Kaleido-X system on an iControl Web page.
- Display EdgeVision alarms along with the stream coming from the EdgeVision on a Kaleido-IP multiviewer.
- Display alarm status information in XEdit (online mode).
- Create virtual alarms that combine a number of alarm statuses, not only within a single system, but also from different devices within multiple Kaleido-X and iControl systems. See [Creating Virtual Alarms](#) on page 164.

In addition, as of version 6.40 of the Kaleido-X software, it is possible to assign elements from any GSM alarm browser to alarm levels in the sources table, directly, by a drag-and-drop operation (see [Configuring logical sources based on external alarm providers](#), on page 187).

## Alarm Browser

The alarm browser is a window, accessible from within iControl Navigator and other iControl applications. XEdit's **Build Virtual Alarm** window features an alarm browser pane. The information that appears in the Alarm Browser is generated by a specific GSM. The alarm browser displays a hierarchical view of all the alarms that have been discovered by the GSM. The alarms may be related to Grass Valley devices, or other supported third-party devices, and are organized into folders. The current status of each alarm is shown as an icon next to its name. These status are dynamically updated.

## Alarm Status

The current status of an alarm determines the color of the LED-like icon to the left of its name, in XEdit, in GSM alarm browsers, and in iControl log viewers. Video monitors, UMDs and alarm monitors have alarm reporting features (e.g. border color and thickness, blink mode, latch) that can be customized in XEdit, when you create a layout.

Each possible alarm status is represented by a color. Alarm statuses are dynamically updated. The Kaleido-X software supports the following alarm status values, described in the table below: *pending*, *normal* (or *OK*), *warning* (or *minor*), *major*, *critical*, *unknown*, *nonexistent*, and *disabled*. In a multiviewer's System list and on the monitor wall, *nonexistent* and *unknown* alarms are considered *disabled*.

Status	Color	Description
Pending	White	Alarm exists but was not reported yet: The software is waiting for the hardware or driver to update the alarm.
Normal (or OK)	Green	No error detected.
Warning (or Minor)	Yellow	Supported for Gateway alarms only.
Major	Orange	Supported for Gateway alarms only.
Critical	Red	Error detected.
Unknown	Gray	Could not get status: Failed to communicate with device to get status. It could happen for example, if the network connection is lost. Another example is a loss of signal that would trigger a critical alarm for signal presence while the alarm state for all other parameters would become unknown. The freeze or black status is disabled if the signal is not present.
Nonexistent	Blue	Alarm that has been removed (or was never added): It can happen if the alarm reference in XEdit does not exist on the multiviewer — for example, if an input card is removed from a Kaleido-X multiviewer. All associated alarms will disappear from the GSM and become disabled on the multiviewer.
Disabled	Black	No alarm assigned to the status indicator: Alarm exists but is disabled at the source by the user. The Kaleido-X software has the ability to deactivate some alarms on the multiviewer hardware itself.

A multiviewer alarm status is only visible in iControl's GSM alarm browser when at least one of the following conditions apply:

- The alarm is already monitored on the monitor wall.
- Someone navigated to this alarm by expanding the System list in iControl or XEdit.
- The alarm is associated with a background action.
- The alarm contributes to a virtual alarm.

When navigating a multiviewer's GSM, by using the alarm browser in iControl, some alarm folders may show a disabled (black) status, until you expand them to reveal the alarms they contain, at which point the folder color will be updated to reflect the status of the alarms.

---

**TIP**

Create a virtual alarm, based on the alarms whose status you want to be able to monitor in real time.

---

In the case of a **Kaleido-IP**, alarms are decoded only when the corresponding source is being monitored on the wall. Alarms associated with sources that are currently not shown on the monitor wall appear with a pending (white) status in a Kaleido-IP System list or GSM alarm browser.

## External Alarm Provider

Once you have declared a device (e.g. an iControl application server, an EdgeVision quality of experience monitoring system, another multiviewer) as an external alarm provider to your multiviewer system, any alarms registered with this device's GSM, in addition to the alarms generated by the current multiviewer system, can contribute to your monitoring and control purposes. See [Managing Alarm Providers](#) on page 163.

---

**IMPORTANT****iControl application server requirement**

In the case of an iControl system involving multiple application servers, there will typically be only one or two of the servers with a lookup service enabled. To qualify as an external alarm provider, an iControl application server must have its lookup service enabled (i.e. it must be a *lookup server*). Refer to the iControl User Guide for more information.

---

## Lookup Service

Grass Valley's monitoring and control products implement a lookup service for discovery and information sharing over a network. A program on one device can use a lookup service to obtain information from remote applications or devices, including alarm-related information from a device's GSM. By default, every multiviewer has a lookup service and can therefore be considered a *lookup server*. For example, before you can use an RCP-200 control panel to operate your monitor wall, the multiviewer must be specified as a lookup server in the RCP-200's configuration (see [Specifying lookup servers for the RCP-200](#), on page 463).

## Alarm Debouncing

Alarm debouncing allows the filtering of false alarms. Two parameters can be calibrated: the time required for an alarm event to be present before the system considers it to be valid (to avoid false triggering of alarms), and the time required for an alarm state to be normal before the system actually clears the alarm (to avoid false releasing of alarms).

An alarm is triggered when a probe is in a continuous error state for the number of seconds specified in the **Set duration** debouncing parameter. By default, the alarm status will revert to normal as soon as the probe returns a normal state. To delay the releasing of an alarm, you can change its **Clear duration** parameter. The default debouncing parameters are as follows:

Attribute	Default value	Range	Description
Set duration	15 seconds	0 s – 300 s	This is the time interval to wait before triggering an alarm once a probe has been in a continuous error state.
Clear duration	0 seconds	0 s – 90 s	Once a probe has returned to a normal state (the alarm condition is no longer detected), this is the time interval to wait before resetting the alarm.

See [Configuring Alarm Debouncing](#) on page 162, for more information.

---

### Notes

- In the case of *video freeze* alarms, the default debouncing settings are appropriate for most purposes, when the intention is to detect a freeze. Note, however, that it may take up to one second (two seconds, in the case of a Kaleido-IP) more than the value of the **Set duration** parameter to trigger a video freeze alarm. On the other hand, if your situation requires detecting movement (e.g. to detect that nothing is put on air during an off-air period) then you may need to set an appropriate reset delay for this alarm (e.g. 5 seconds) by using the **Clear Duration** parameter.
  - In the case of *video black*, *video luma too high*, and *teletext presence* alarms, it may take up to one second more than the value of the **Set duration** parameter to trigger these alarms, and it may take up to one second more than the value of the **Clear duration** parameter before the system clears them.
  - As of version 6.60 of the Kaleido-X software, the former **Occurrences** and **Detection window** debouncing parameters have been removed. You may need to revise your system's alarm debouncing calibrations when you upgrade to version 6.60 (or later) from version 6.50 (or earlier). Refer to the upgrade instructions in the Kaleido-X Release Notes, for details.
- 

## Alarm Suppression

Alarms that are not relevant—momentarily or on a recurrent basis—can be squelched, either manually or by defining schedules, so that only meaningful alarm information

remains to be monitored. A schedule can put an alarm in either of the following operational modes: *offline*, *in maintenance*, or *inverted*.

---

**Note:** A background action triggered by an alarm is executed, regardless of the alarm's operational mode (see [Creating Background Actions](#), on page 304).

---

## Global Alarms

A logical source comprises different level categories, including alarms (see [Logical source](#), on page 177). Each logical source can include multiple alarm levels: one for each alarm state that can be reported to the Kaleido-X system. In many cases, a single, combined status, based on all the alarms in every alarm level for a logical source, is more useful than having to individually assess each and every alarm condition detected. Such a global alarm combines all the individual alarm statuses into an overall status, where the most critical events take precedence.

**Example:** Three alarms occur, two of which can be acknowledged without further action, while the other one is considered an Error. In such a case, the overall alarm status would be Error.

The Kaleido-X software creates one global alarm for every logical source. The global alarms are not directly exposed in the **Channels/Sources** tab, but you can configure which alarm levels contribute to them (see [Configuring an alarm level's contribution](#), on page 183). If you have disabled global alarm contribution for all alarm levels, then the global alarms are *not* generated.

---

**Note:** If you choose to configure your multiviewer system with a large number of logical sources (i.e., more than 1500), you should disable global alarm contribution for all alarm levels in the sources table, to improve the system performance.

---

In the **Layouts** tab, you can assign a global alarm to a layout element that supports alarm reporting, like a UMD or an alarm monitor: in the **Properties** pane, the lists of alarm levels that can be assigned to a monitor include the item *GlobalAlarm*, along with all the individual alarm levels.

You can select this global alarm not only as an alarm status, but also as a text label. When an individual alarm is in Error, its friendly name will contribute to the global alarm text value. When the global alarm level is assigned to an alarm monitor, the text values for all contributing alarms currently in Error will be visible.

See [Configuring Video Monitors](#) on page 236, [Configuring UMDs](#), on page 267, [Configuring Alarm Monitors](#), on page 274, and [Configuring Subtitling Monitors](#), on page 277), for detailed instructions.

## Virtual Alarm

A virtual alarm allows you to derive a result from the status of one or more existing alarms. Any alarms — including other virtual alarms — can be combined together to form a new, higher-level virtual alarm. Since a virtual alarm can be composed of virtual alarms other than itself, there can be many levels of virtual alarms within a particular virtual alarm. At this

time there is no limit to the number of levels that a virtual alarm can have. See [Creating Virtual Alarms](#) on page 164.

---

**Note:** Creating a virtual alarm that includes itself as a sub-alarm, directly or indirectly, creates a cyclical dependency. XEdit does not automatically check for this dependency. Your multiviewer will, however, perform cycle validation and will record an error in `vroom.log` if such a condition is detected.

---

## Sub-Alarm

A sub-alarm is an alarm that contributes to the status of a higher-level virtual alarm. The effect of a sub-alarm's contribution is determined by the way in which the higher-level alarm is configured.

## Alarm Monitor

Alarm monitors help you see the status of global and virtual alarms, but their use is not limited to this type of alarms. When any alarm level is assigned to an alarm monitor, the status of this alarm will be shown. When using the global alarm at the text label level, it will display the text value of the alarm, which is a readable name. See [Configuring Alarm Monitors](#) on page 274, for more information.

## Teletext, Subtitles, and Closed Captions

In the case of a Kaleido-MX, Kaleido-Modular-X, Kaleido-X, or Kaleido-X16 multiviewer, teletext subtitling (based on WST or SMPTE RDD 8 / Free TV Australia OP-47), NTSC closed captioning (CEA-608), and ATSC Digital Television Closed Captioning (CEA-708 DTVCC) can be displayed on the monitor wall, allowing visual monitoring of decoded text from an analog or SDI video source. The lines of text extracted from the video source metadata are displayed within the corresponding video window.

The Kaleido-IP can monitor teletext and subtitling from DVB streams, and subtitling from SCTE 27 streams. The lines of text extracted from a DVB subtitling compliant with ETSI EN 300 743 V 1.2.1 (2002-10), or from a SCTE 27 subtitling stream can be displayed within the corresponding video window, or in a subtitling monitor. In the case of DVB teletext streams, the lines of text are displayed within the corresponding video window.

Teletext may comprise up to 799 pages of displayable data (numbered from page 100 to 899). Teletext subtitles are decoded as described by the ETSI EN 300 472 V1.3.1 (2003-05) standard (for Kaleido-IP) or ETSI ETS 300 706 (for the other multiviewer models). The Kaleido-IP can decode up to eight pages from a DVB teletext stream, and monitor teletext, subtitle, and text presence for each of the selected pages. In the case of the Kaleido-X, Kaleido-X16, Kaleido-MX, and Kaleido-Modular-X, only one page can be decoded per video monitor and only one page can be decoded per video source, for monitoring purposes. However, these multiviewers can monitor the presence of up to four pages. Refer To [Setting a Video Monitor's Text Mode](#), on page 248, and [Displaying Subtitles and Closed Caption Text](#), on page 45, for more information.

The CEA-708 standard supports legacy CEA-608 data. In the case of an HD-SDI source carrying both 708 captions and 608 legacy caption data, the multiviewer will display the



708 captions, and automatically fall back to displaying the 608 captions only if the 708 data becomes unavailable.

In the case of a Kaleido-IP, when a video or subtitling monitor's *text mode* is set to **Auto sense**, and the associated source carries more than one type of captioning, teletext or subtitling data, decoding precedence is as follows: DVB subtitling, SCTE 27 subtitling, DVB teletext (WST), CC (608). For example, DVB teletext is only decoded if there is no DVB subtitling, and no SCTE 27 subtitling available.

For the other multiviewer models, the following table shows which of captioning, teletext, or subtitling data is decoded by default for each supported video format, when a video monitor's text mode is set to **Auto sense**: DTVCC (708), CC (608), teletext (RDD 8/OP-47, or WST).

Video format	Decoded data	Video format	Decoded data
SDI 525	CC (608)	1080i59.94	DTVCC (708)
SDI 625	Teletext	1080PsF23.98	N/A
NTSC <sup>1</sup>	CC (608)	1080PsF24	N/A
PAL <sup>2</sup>	Teletext	1080PsF25	Teletext
SECAM	Teletext	1080PsF29.97	DTVCC (708)
720p24	N/A	1080p23.98	N/A
720p25	N/A	1080p24	N/A
720p29.97	DTVCC (708)	1080p25	N/A
720p50	Teletext	1080p29.97	DTVCC (708)
720p59.94	DTVCC (708)	1080p50	Teletext
1080i50	Teletext	1080p59.94	DTVCC (708)

1. All supported NTSC formats.

2. All supported PAL formats.

## Dolby E/AC-3 Metadata

In the case of a Kaleido-MX, Kaleido-Modular-X, Kaleido-X, or Kaleido-X16 multiviewer, metadata (*Dialnorm* and *Program config*) information contained in a Dolby E audio stream can be exposed on the monitor wall in text form. Dolby E and PCM audio levels can be displayed via audio monitors. Decoding of Dolby E metadata embedded as ancillary data (VANC) in the video stream is also supported.

- If multichannel audio (up to 8 channels) is coded in a Dolby E stream and transported over a single AES channel, metadata and audio levels are extracted from the Dolby E stream:
  - Limited to two embedded audio sources, selectable, no ABT support
  - VU and Peak meters (8 channels), for each source
  - Program config, for each source
  - Dialnorm for program 1, for each source
- If multichannel audio (up to 16 channels) is transported as regular AES channels (up to 8) in the SDI embedded audio, metadata is extracted from VANC packets:

- Program config
- Dialnorm for program 1
- VU and Peak meters come from the AES in PCM

## Definitions

Term	Definition
Dolby E stream	A coded (compressed) 8-channel digital stream that fits inside an AES channel (L/R)
Dolby metadata	Metadata of Dolby E type such as <i>dialnorm</i> and <i>program config</i>
Dolby E extracted [metadata]	Dolby metadata extracted from a Dolby E stream. Includes audio level data from encoded audio data
VANC extracted [metadata]	Dolby metadata extracted from VANC packets. Audio level data is probed directly from the PCM AES signal
Embedded audio source or channel	Any of the 8 SDI or HD-SDI embedded audio AES signals
AES signal or source	A bit stream for audio service
Multichannel audio	Audio service or essence composed of more than 2 channels of audio (more than Left and Right)

## Audio Format

The format of each audio channel (PCM, Dolby AC-3, Dolby E, other or Unavailable) is reported as a text attribute, that can be assigned to a text level within a logical source.

## Metadata

The metadata extracted from the VANC and from the Dolby E is available as text in the XEdit hierarchical system list, and therefore can be exposed via any layout element capable of displaying text levels from logical sources (currently only UMDs).

*Dialnorm* is displayed as a numeric value between -31 and -1 dB. *Program Config* is displayed as the Dolby E Program Config description. *Unavailable* is displayed if the source is not being decoded, or is not Dolby E.

## Logical Source Assignment

Logical source assignment is performed by dragging an AES pair onto a logical source's audio level.

For Dolby E, if the AES pair is calibrated as a Dolby E source, then the 8 channels are available to be displayed by an audio monitor. The channel displayed by the audio monitor depends on how the monitor was configured.

For Dolby VANC, if the audio monitor is set to **Auto** or **Dolby VANC**, the VANC metadata from the video of the assigned AES will be decoded. The audio monitor will have access to all amended audio peaks depending on VANC program configuration (regardless of which AES pair was assigned to the logical source).

## Microphone Loudness Measurement

Kaleido-X and Kaleido-X16 multiviewers are capable of providing *microphone loudness* measurement as dynamic text values, for Audio Bridge Terminal (ABT) sources. Values are available for every ABT channel, and can be displayed in a UMD (or in an alarm status monitor), provided you configured logical sources with the appropriate text levels (see [Configuring Dynamic UMD Text](#), on page 272, for example). Support is limited to one ABT per multiviewer. *Playout is assumed to be mono*. The measurement is optimized for voice content. The values (in dBFS) are updated every second, and have a precision of 0.5 dB.

## Detailed Directions

### Configuring Alarm Thresholds

---

**Note:** With the current version of the Kaleido-X software, the KMV-3901/3911, and Kaleido-XQUAD support *audio* alarm threshold calibrations only. The Kaleido-IP supports *audio* and *teletext* alarm threshold calibrations.

---

#### To configure the threshold for a video or audio alarm

- 1 Connect to the multiviewer you wish to configure, if you wish to apply the changes in real time (see [Connecting to a Multiviewer](#), on page 76).

---

**Note:** If this step is omitted, then you will need to export the database to apply the calibration changes.

---

- 2 In the main window, click the **System** tab, and then:

- In the case of a Kaleido-IP, click **Calibrations (Kaleido-IP)** on the second-level tab bar, select the appropriate calibration profile in the **Tools** pane, and then click the alarm whose threshold you wish to calibrate in the main pane.

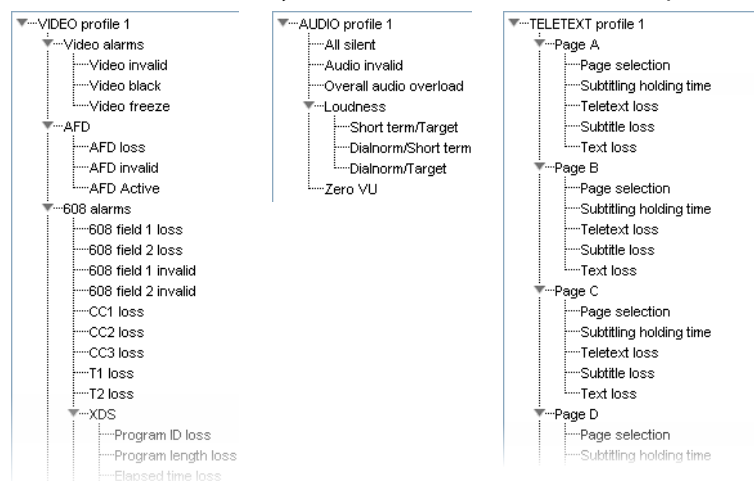

- For all other multiviewer models, click **Description/Calibrations** on the second-level tab bar, navigate to the alarm whose threshold you wish to calibrate, by

expanding the appropriate multiviewer input, one of its Video elements, and then the alarm-related elements (or the ABT element, and then one of the ABT's audio elements).

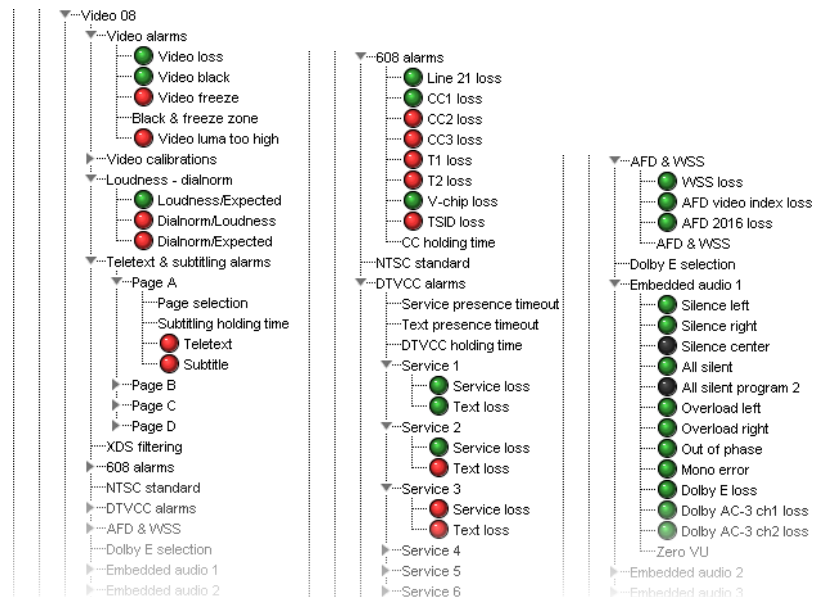

Example of alarms related to video and embedded audio input signals, for Kaleido-X, Kaleido-X16, and KMV-3901/3911 multiviewers.

3 In the **Properties** pane, set the relevant values under **Calibration**.

Video Calibrations





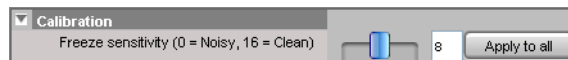

**Black detection threshold** Set the level (in IRE or mV) below which the signal will be considered to be black. By default the threshold is set at 8 IRE.



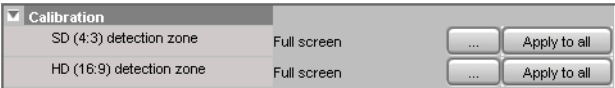



**Freeze sensitivity** Freeze detection is done by comparing successive frames. Noise in the signal could disrupt this process, so filtering is added to remove it. Adjust the sensitivity according to the signal being monitored, on a range of 0 (for a noisy signal) to 16 (for a clean signal). By default the sensitivity is set at 8, and the alarm will be triggered after at least 15 seconds of continuous freeze. Once the alarm is triggered it will only be released if no other freeze condition is detected over the period determined by the **Clear duration** parameter (by default, there is no delay), to avoid unwanted alarm flickering that could be caused by glitches on the signal.

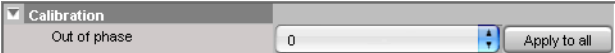

Note that when setting the **Clear duration** parameter to any value other than 0, it may happen that the freeze alarm will only be released after a long time (longer than the value of the period determined by the **Clear duration** parameter) if the video has short-duration freezes during this period.

SD/HD detection zone	<p>Determine the video window area to be monitored for Freeze and Black detection. Two detection zones can be configured: one for SD signals, one for HD signals.</p>  <p>The screenshot shows a 'Calibration' window with two rows. The first row is for 'SD (4:3) detection zone' with a 'Full screen' dropdown and 'Apply to all' button. The second row is for 'HD (16:9) detection zone' with a 'Full screen' dropdown and 'Apply to all' button.</p>
Luma too high detection threshold	<p>Set the level (in IRE or mV) above which <i>Luma too high</i> will be reported. By default the threshold is set at 100 IRE.</p>  <p>The screenshot shows a 'Calibration' window for 'Luma too high detection threshold'. It features a dropdown menu set to 'IRE', a slider, and a numeric input field set to '100', with an 'Apply to all' button.</p>
<b>Audio Calibrations</b>	
Silence left/right/center	<p>Select the level (in dB or dBFS for digital audio sources, in dB or dBu for analog audio sources) below which the audio signal will be considered silenced. The default value is -55 dBFS, on a range of -63 to 0.</p>  <p>The screenshot shows a 'Calibration' window for 'Silence center'. It features a dropdown menu set to 'dBFS', a slider, and a numeric input field set to '-55', with an 'Apply to all' button.</p>
All silent / All silent program 2	<p>Select the level (in dB or dBFS for digital audio sources, in dB or dBu for analog audio sources) below which an audio signal will be considered silenced. An alarm is raised if all available channels are below the threshold. The default value is -55 dBFS, on a range of -63 to 0.</p>  <p>The screenshot shows a 'Calibration' window for 'All silent'. It features a dropdown menu set to 'dBFS', a slider, and a numeric input field set to '-55', with an 'Apply to all' button.</p>
Overload left/right	<p>Select the level (in dB or dBFS for digital audio sources, in dB or dBu for analog audio sources) above which the audio signal will be considered overloaded. The default value is -5 dBFS, on a range of -63 to 0.</p>  <p>The screenshot shows a 'Calibration' window for 'Overload left'. It features a dropdown menu set to 'dBFS', a slider, and a numeric input field set to '-5', with an 'Apply to all' button.</p>
Overall audio overload	<p>Select the level (in dB or dBFS) above which an audio signal will be considered overloaded. An alarm is raised if any available speaker is above the threshold. The default value is -5 dBFS, on a range of -63 to 0. Available for Kaleido-IP only.</p>  <p>The screenshot shows a 'Calibration' window for 'Overall audio overload'. It features a dropdown menu set to 'dBFS', a slider, and a numeric input field set to '-5', with an 'Apply to all' button.</p>
Out of phase	<p>Select the sensitivity level below which the audio signal will be considered out of phase. The sensitivity is a value between -1 and +1, where -1 means completely out of phase and +1 means perfectly in phase. The default value is 0.</p>  <p>The screenshot shows a 'Calibration' window for 'Out of phase'. It features a numeric input field set to '0' and an 'Apply to all' button.</p>

Mono	<p>An audio source is considered to be mono if the left and right signals are perfectly in phase (i.e. more likely to be the same). Select the sensitivity level above which audio will be considered mono. The sensitivity is a value between -1 and +1, where -1 means that everything is considered to be mono, and +1 means that only perfectly in phase audio will be considered mono. The default value is 1 (Perfectly in phase).</p> 
<b>Metadata Calibration</b>	
DTVCC service presence timeout	<p>Set the delay (in seconds) after which a service presence timeout alarm will be triggered. This calibration applies to the six standard services. The default value is 30 seconds, on a range of 1 to 360.</p> 
DTVCC text presence timeout	<p>Set the delay (in seconds) after which a text presence timeout alarm will be triggered. This calibration applies to the six standard services. The default value is 30 seconds, on a range of 1 to 360.</p> 
Text loss	<p>Set the delay (in seconds) after which a text presence timeout alarm will be triggered for the configured WST subtitling page. The default value is 30 seconds, on a range of 1 to 360. <i>Currently available for Kaleido-IP only.</i></p> 

## Configuring Alarm Debouncing

### To configure alarm debouncing

- 1 Connect to the multiviewer you wish to configure, if you wish to apply the changes in real time (see [Connecting to a Multiviewer](#), on page 76).

---

**Note:** If this step is omitted, then you will need to export the database to apply the new calibrations to the multiviewer.

---

- 2 In the main window, click the **System** tab, and then:
  - In the case of a Kaleido-IP, click **Calibrations (Kaleido-IP)** on the second-level tab bar, select the appropriate calibration profile in the **Tools** pane, and then click the alarm whose debouncing you wish to calibrate in the main pane.

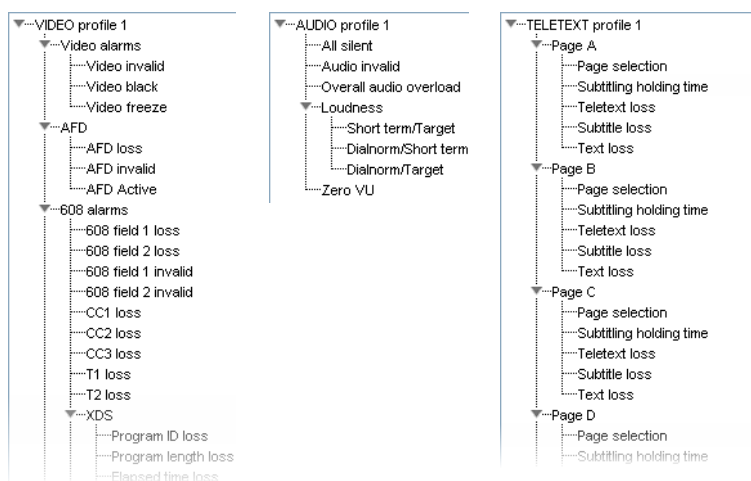

- For all other multiviewer models, click **Description/Calibrations** on the second-level tab bar, navigate to the alarm whose debouncing you wish to calibrate, by expanding the appropriate multiviewer input, one of its Video elements, and then the alarm-related elements (or the ABT element, and then one of the ABT's audio elements).
- 3 In the **Properties** pane, under **Debouncing**, set appropriate values (see [page 154](#)) for the **Set duration** and **Clear duration** attributes.



## Managing Alarm Providers

### To add alarm providers to your Kaleido-X system

- 1 In the main window, click the **System** tab, and then click **Description/Calibrations** on the second-level tab bar.  
A hierarchical list representing the current system appears.
- 2 Click the multiviewer whose alarm providers you wish to define.
- 3 In the **Properties** pane, click the **Alarm providers list** box.

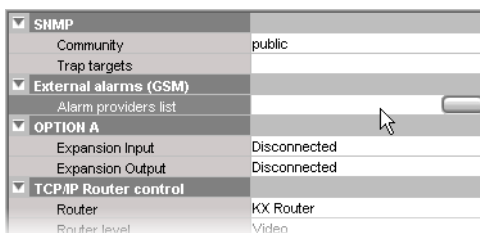

- 4 Click the button that appeared at the end of the box to open the **External Alarm Providers Configuration** window.



- 5 In **External Alarm Providers Configuration**, review the alarm providers list, and then add or remove devices, as required.

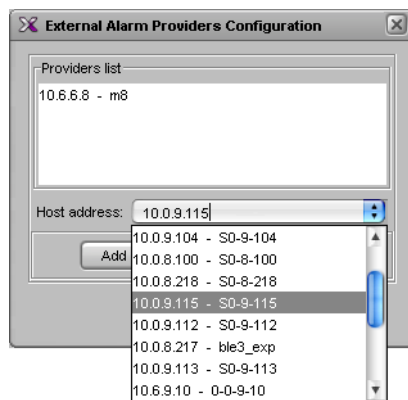

- To add a device to the providers list, select the device from the **Host address** list, and then click **Add**.
- To remove a device from the alarm providers list, select it, and then click **Remove**.

---

**Note:** To qualify as an external alarm provider, an iControl application server must have its lookup service enabled. See [External Alarm Provider](#) on page 153.

---

- 6 Once you have added all devices required for your purposes, click **OK** to close the window.
- 7 On the **File** menu, click **Save**.

## Managing Virtual Alarms

### Creating Virtual Alarms

#### To create a virtual alarm

- 1 Connect XEdit to the multiviewer (see [Using XEdit Online](#), on page 75).
- 2 On the **Tools** menu, click **New virtual alarm**.



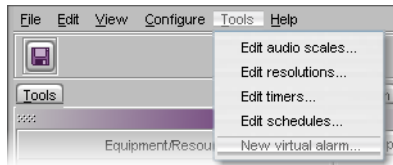

Alternatively, after clicking the Actions tab, or while a *text* or *alarm* level is selected in the sources table you can:

- Right-click **Virtual alarms** in the filtered System list, point to **Virtual alarm**, and then click **New**.

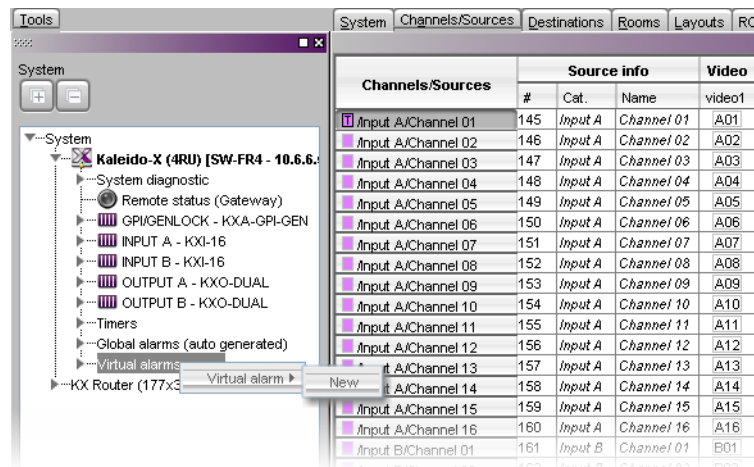

- Expand **Virtual alarms** in the filtered System list, right-click any existing virtual alarm, point to **Virtual alarm**, and then click **New**.

The **Build Virtual Alarm** window appears.

Alarm providers

Alarm browser

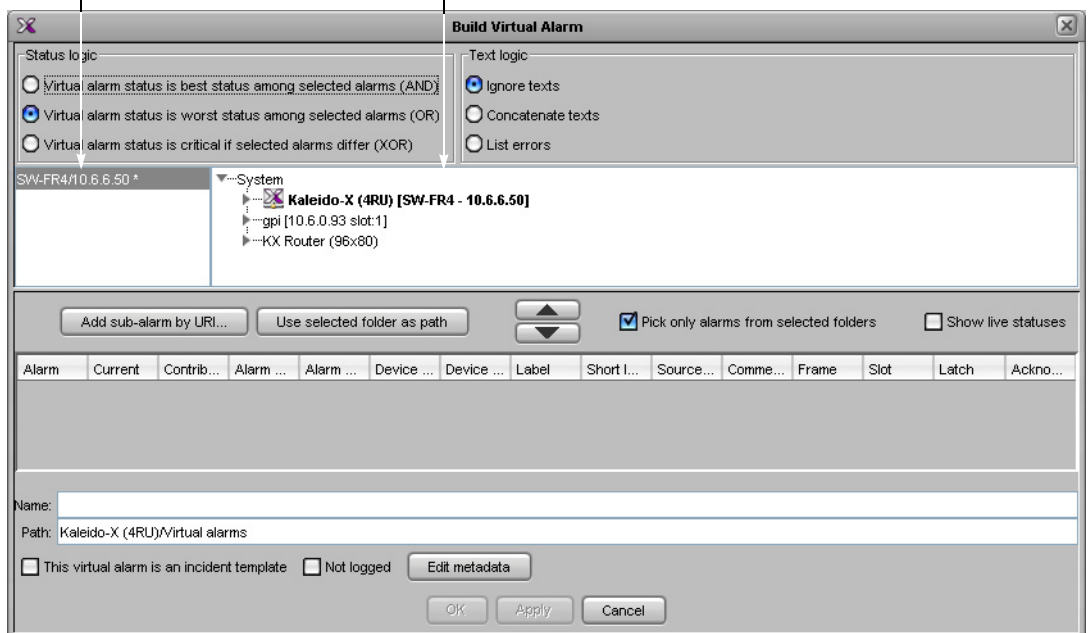

- 3 In the **Status logic** section, select one of the following three options:

**Virtual alarm status is best status among selected alarms (AND)** — Choose this option to have the contribution of the sub-alarms calculated using the *optimistic* version of the alarm logic tables.

**Virtual alarm status is worst status among selected alarms (OR)** — Choose this option to have the contribution of the sub-alarms calculated using the *pessimistic* version of the alarm logic tables. This is the most common option, since it brings changes in the status of any sub-alarms to the attention of the operators.

**Virtual alarm status is critical if selected alarms differ (XOR)** — Choose this option to have the contribution of the sub-alarms calculated using the *XOR* version of the alarm logic tables. This causes the virtual alarm to reflect whether or not all of its sub-alarms have the same status. If all sub-alarms are the same, the virtual alarm will be green. Otherwise, it will be red.

For a more detailed description of the difference between these options, refer to “Understanding the Alarm Logic Tables” in the iControl User Guide.

- In the **Text logic** section, determine what to include in this virtual alarm’s text attribute by selecting one of the following three options:

**Ignore texts** — No text logic (default).

**Concatenate texts** — Concatenate the text attributes from all sub-alarms.

**List errors** — List the text attributes from the sub-alarms that are in error.

- Select the alarm provider you wish to use from the list in the left-hand part of the GSM alarm browser pane.

- In the right-hand part of the alarm browser, select the alarms that are to be sub-alarms of the new virtual alarm, and then click the large down arrow button to transfer them to the table in the bottom half of the window.

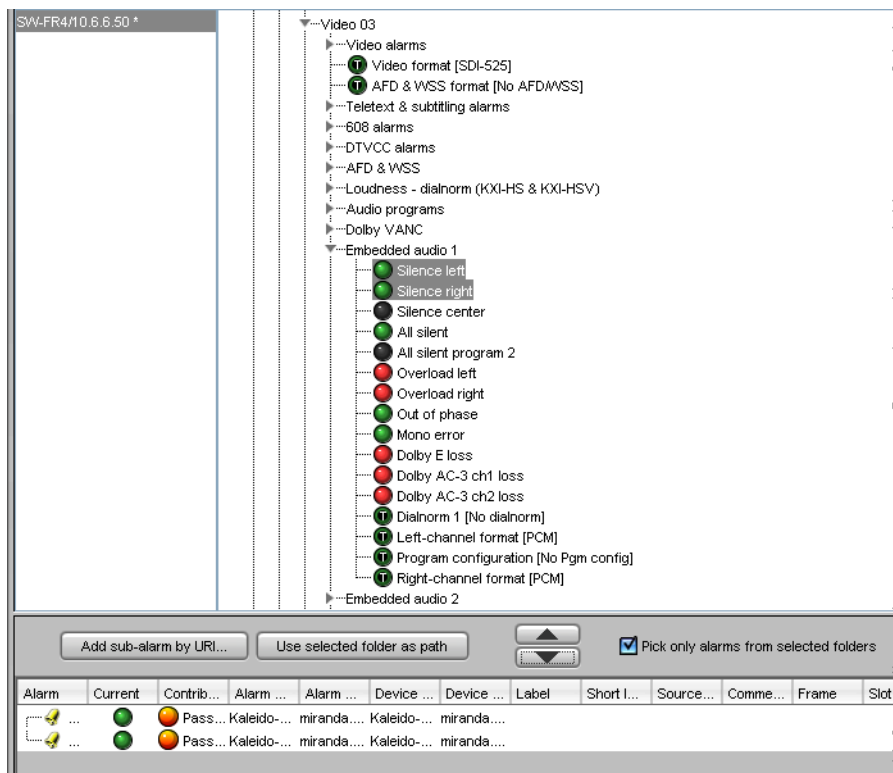

- 7 The table displays various details about the sub-alarms you have selected, including their *contribution*, which defines how a sub-alarm will pass its status on to the virtual alarm. The default contribution value is **Passthrough**, which means the sub-alarm will pass its status unaltered to the overall calculation of the virtual alarm.

It is possible to override the error status of sub-alarms when they are triggered. This is useful when, for example, a device is only able to report a status of either *normal* (green) or *error* (red), but you want the error condition to be considered as *minor* (yellow) in the virtual alarm calculation. To change a sub-alarm's contribution, click in the **Contribution** column, and then select the status you want the virtual alarm to use when an error occurs.

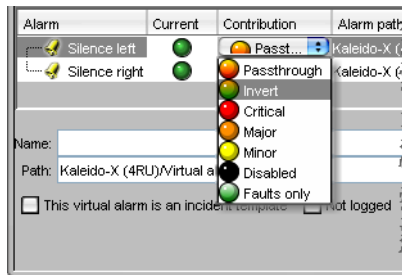

For example, if a sub-alarm goes from green to orange or red, but the selected contribution is yellow, the virtual alarm will “see” yellow (the virtual alarm’s overall status may still depend on other sub-alarms).

The **Invert** contribution allows performing a logical “NOT” calculation on sub-alarms. This feature can be used, for example, to report alarms from GPI inputs. It can also be used to handle cases where an error is expected, and *not* seeing an error is a sign that something probably went wrong. The table below describes the result of inverting sub-alarms:

Sub-alarm status	Inverted contribution
NORMAL	ERROR
MINOR	NORMAL
MAJOR	NORMAL
CRITICAL	NORMAL
NON-EXISTENT	NON-EXISTENT
PENDING	PENDING
DISABLED	DISABLED
UNKNOWN	UNKNOWN

Selecting the **Faults only** contribution causes a sub-alarm to be mapped to NORMAL unless it is in one of the fault statuses—usually CRITICAL, MAJOR, and MINOR. Refer to the iControl User Guide for more information.

**Note:** If the sub-alarm’s fault condition is cleared, its contribution will always be *green* (NORMAL), unless the value specified in the **Contribution** column is *black* (DISABLED).

- 8 Repeat from [step 5](#), until you have added all the required sub-alarms.
- 9 Specify a name for the new virtual alarm in the **Name** box.  
You may adjust the default path, if necessary, so that alarms be grouped in the desired way.

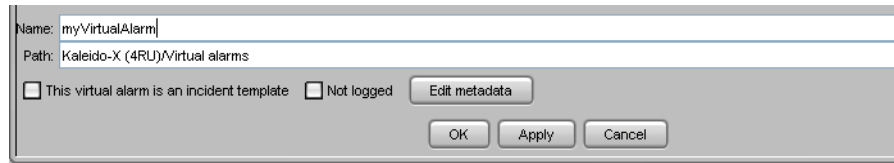

- 10 Configure logging behavior as required (see [Managing Alarm Logging](#), on page 171):
  - If you wish to disable logging for this virtual alarm, then select **Not logged**.
  - If you wish to have occurrences of this virtual alarm logged as *incidents*, select **This virtual alarm is an incident template**. Refer to the iControl User Guide for more information.
  - To add relevant information for your logging purposes, click **Edit metadata**.The **Virtual Alarm Metadata** window appears.

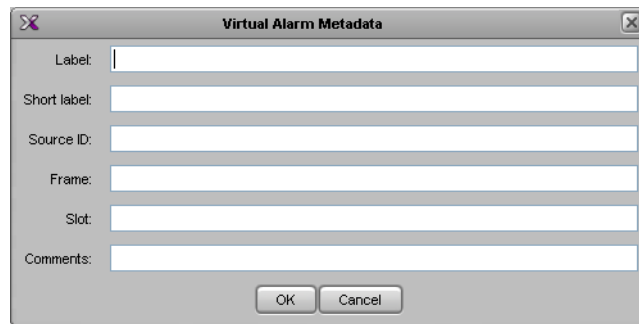

The information you provide for this virtual alarm can be used to sort and locate events and incidents in the iControl log viewers. For example, a meaningful Source ID may help you distinguish this virtual alarm's sub-alarms from other alarms. Click **OK** to close the window.

- 11 Click **OK**.  
The **Build Virtual Alarm** window closes and the newly created alarm appears at the specified path, under **Virtual alarms**, in your multiviewer's filtered System list (e.g. when a text or alarm level is selected in the sources table).

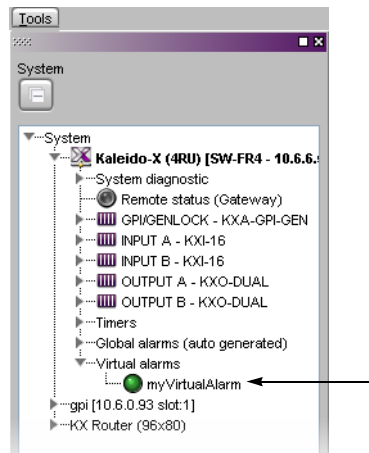

If the multiviewer's IP address was added to an iControl applications server's **Service and alarm discovery** table<sup>1</sup> you will also be able to manage your multiviewer's virtual alarms from the multiviewer's GSM, by using the iControl GSM alarm browser.

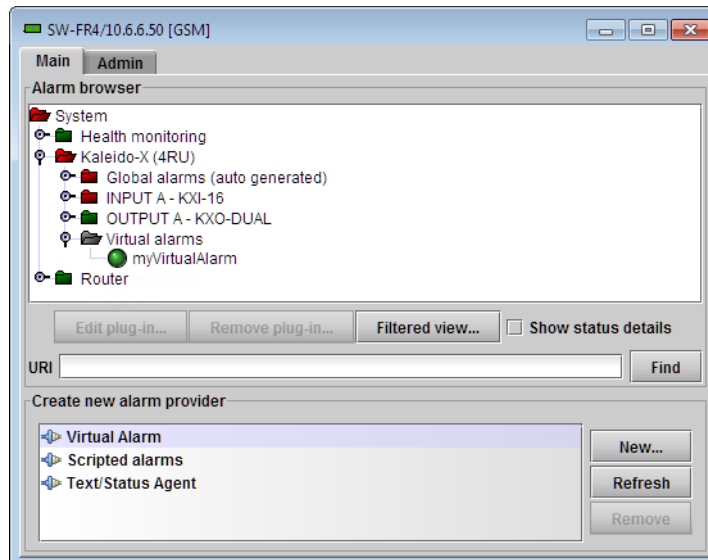

## Modifying Virtual Alarms

### To modify a virtual alarm

- 1 In the sources table, select a text or alarm level.  
Alternatively, click the **Actions** tab.
- 2 Expand the filtered System list, and navigate to the virtual alarm you wish to modify.
- 3 Right-click the alarm, point to **Virtual alarm**, and then click **Edit**.

1. To access the iControl Lookup locations page, where you can review and update the **Service and alarm discovery** table, click **System tools** on the Startup page, and then click **Edit service locations**.

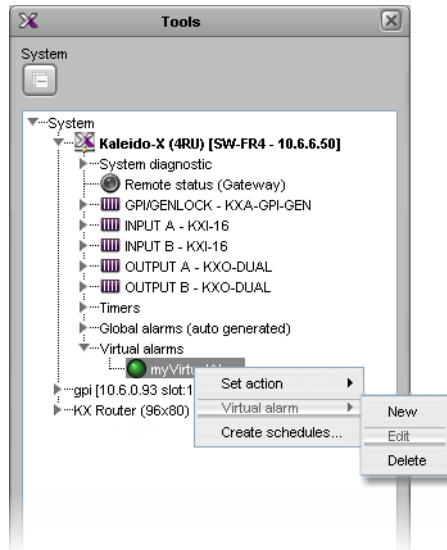

The **Build Virtual Alarm** window appears.

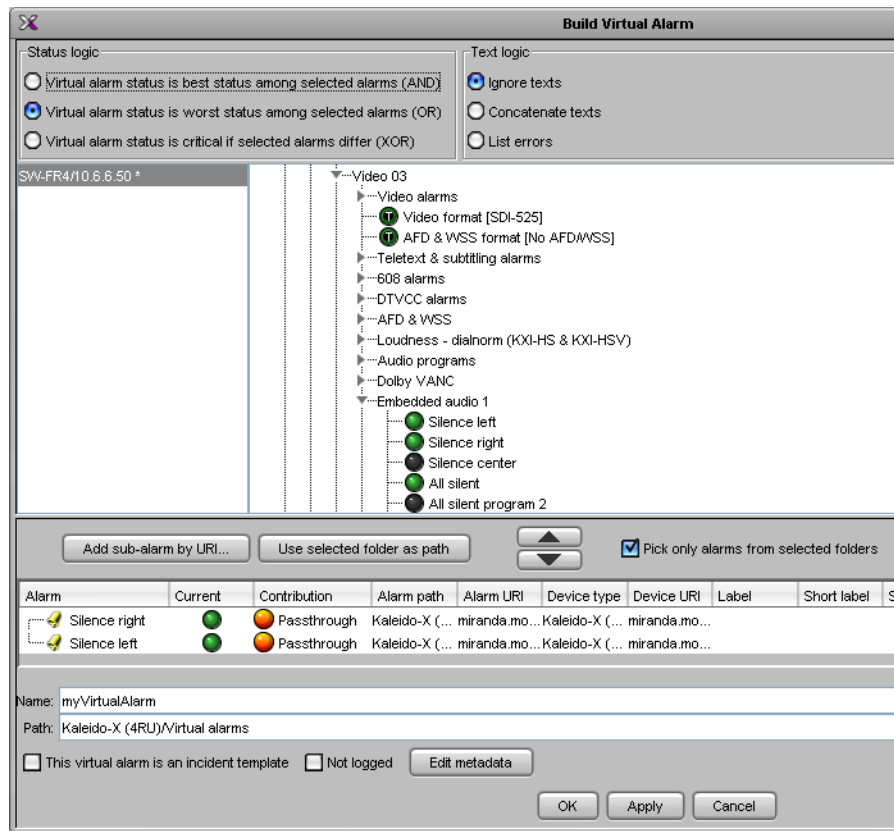

- 4 Modify your virtual alarm, by adding or removing sub-alarms, changing their contribution, the alarm name or path, etc. Refer to [Creating Virtual Alarms](#), on page 164, as needed. For example:
  - after selecting the sub-alarms you wish to remove from the table in the bottom half of the window, click the large up arrow button.

- after selecting the appropriate alarm provider from the list in the left-hand part of the GSM alarm browser pane, select the sub-alarms you wish to add, from the right-hand part of the alarm browser, and then click the large down arrow button to transfer them to the table in the bottom half of the window.
- 5 Once you have completed your changes, click **OK** to close the **Build Virtual Alarm** window.

## Deleting Virtual Alarms

### To delete a virtual alarm

- 1 In the sources table, select a text or alarm level.  
Alternatively, click the **Actions** tab.
- 2 Expand the filtered System list, and navigate to the virtual alarm you wish to delete.
- 3 Right-click the alarm, point to **Virtual alarm**, and then click **Delete**.

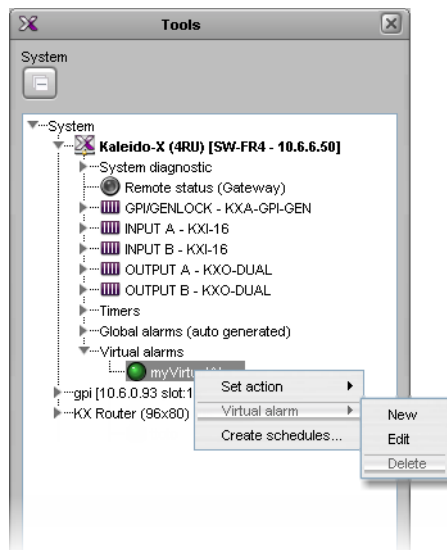

XEdit prompts you to confirm.

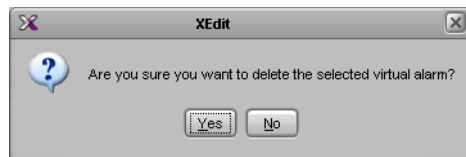

- 4 Click **Yes** to proceed.  
The selected virtual alarm is removed from your configuration.

## Managing Alarm Logging

As part of the alarm calibration process, you can specify that an alarm, when triggered, be logged to an iControl application server that has a GSM log plug-in configured for this multiviewer. As of version 6.50 of the Kaleido-X software, alarms logged to an iControl application server include time code information from the corresponding video signal (ATC or VITC, depending on the signal format).

- By default, native alarms are not logged. See [Enabling logging for a native alarm](#) on page 172.
- Virtual alarms are logged by default. See [Disabling logging for a virtual alarm](#) on page 172. When a virtual alarm status changes, then the native sub-alarms that triggered the change are logged even if logging is disabled for these sub-alarms.
- Global alarms are always logged. It is possible, however, to disable alarm logging for a global alarm, by editing the corresponding plug-in from the iControl application server's GSM alarm browser. Refer to the iControl User Guide, for more information.

## Enabling logging for a native alarm

To allow an alarm to be logged to the GSM log plug-in configured for this system

- 1 In the main window, click the **System** tab, and then click **Description/Calibrations** on the second-level tab bar.

A hierarchical list representing the current system appears.

- 2 Expand the multiviewer whose alarms you wish to log, navigate to the appropriate alarm, and then click the alarm to select it.

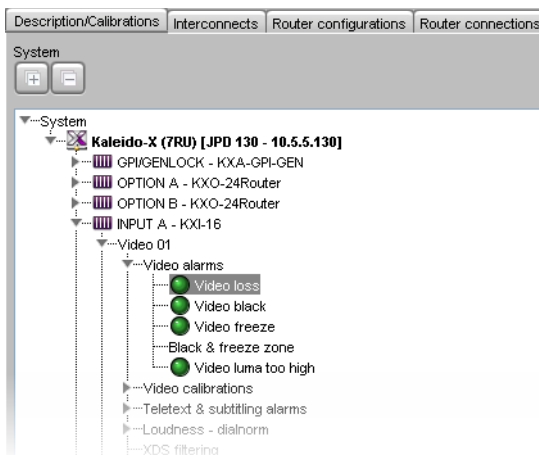

- 3 In the **Properties** pane, select the **Logging enabled** check box to have the multiviewer publish this alarm to the application server's log, each time this alarm is triggered.



- 4 Click **Apply to all** if you wish to apply this setting to *all other alarms with the same name*, throughout the system.

In the example, clicking **Apply to all** will enable logging for the *Video Loss* alarm on every multiviewer input in your system.

- 5 Repeat the procedure until logging is enabled for all desired alarms.
- 6 On the **File** menu, click **Save**.

## Disabling logging for a virtual alarm

To prevent a virtual alarm from being logged to the GSM log plug-in

- 1 In the sources table, select a text or alarm level.



Alternatively, click the **Actions** tab.

- 2 Expand the filtered System list, and navigate to the virtual alarm you wish to modify.
- 3 Right-click the alarm, point to **Virtual alarm**, and then click **Edit**.

The **Build Virtual Alarm** window appears.

- 4 In the bottom area of the window, select **Not logged**.
- 5 Click **OK** to close the **Build Virtual Alarm** window.

## Publishing Alarms to SNMP Devices

### Notes

- This section does not apply to the KMV-3901/3911 multiviewer models, which do not support SNMP-related calibrations and settings.
- In the case of a Kaleido-IP multiviewer, the SNMP status for an alarm is valid, only when the corresponding source is monitored on the monitor wall.
- MIB files are available from your multiviewer. To access them, point your browser to:  
<http://<your multiviewer's IP address>/pub/KALEIDO-KX-MIB.mib>,  
 and  
<http://<your multiviewer's IP address>/pub/MIRANDA-MIB.mib>.

The Kaleido-IP, Kaleido-MX, Kaleido-Modular-X, Kaleido-X and Kaleido-X16 multiviewers support the use of Simple Network Management Protocol (SNMP) traps to notify an external SNMP manager of significant events. These significant events are flagged within the Kaleido-X system as alarms.

Two actions are required to set up the SNMP trap process:

- Identify the targets (SNMP managers) to which SNMP traps will be sent.
- Choose the traps that will be sent to the selected SNMP managers.

## Defining Target SNMP Managers

### To define target SNMP managers

- 1 In the main window, click the **System** tab, and then click **Description/Calibrations** on the second-level tab bar.  
A hierarchical list representing the current system appears.
- 2 Click the multiviewer whose SNMP trap targets you wish to define.
- 3 In the **Properties** pane, click the **Community** box (which contains "public" by default), and then type a new name for the group of target SNMP managers.

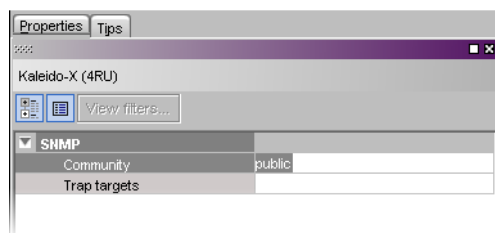

- 4 Click the **Trap targets** box.



- 5 Click the button that appeared at the end of the box to open the **SNMP Configuration** window.

The trap targets list shows all trap targets currently identified for the selected multiviewer. SNMP Managers that are trap targets for this multiviewer are identified by their host address and port number.

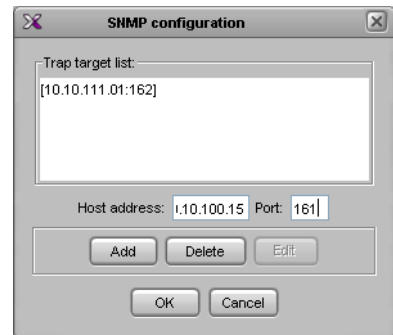

- 6 Add, remove, or modify trap targets as needed, and then click **OK** to confirm and apply the changes, or click **Cancel** to close the **SNMP Configuration** window without saving your changes to the trap targets list.

#### To add a trap target to the list

- 1 In the **Host address** box, type the IP address of the device that has the target SNMP manager.
- 2 In the **Port** box, type the port number through which the SNMP manager will be accessed.
- 3 Click **Add**.  
The new trap target is added to the list.

#### To modify an existing trap target

- 1 Click the trap target you wish to modify in the list.  
It becomes highlighted and its host address and port number appear in the data boxes, and the **Edit** button is available.
- 2 Type new or revised data in the data boxes.
- 3 Click **Edit**.  
The revised data appears in the target list.

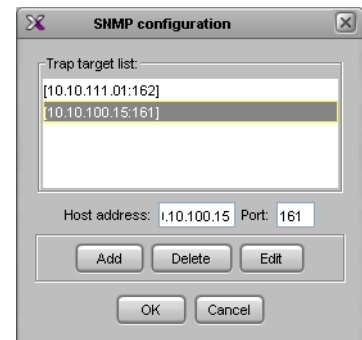

#### To remove a trap target from the list

- 1 Click the trap target you wish to remove in the list.  
It becomes highlighted and its host address and port number appear in the data boxes.
- 2 Click **Delete**.  
The trap target is removed from the list.

---

**Note:** The host address and port number remain in the data boxes. Hence the trap target can easily be added back to the list, by clicking **Add**, if it was removed in error.

---

## Enabling SNMP Traps

The multiviewer analyses the signals that pass through it, and can detect and flag problems by raising alarms. Each alarm can be individually configured. Most alarm definitions specify detection thresholds, a *set duration*, and a *clear duration*, in order to exclude transient events. See [Configuring Alarm Thresholds](#) on page 159, and [Configuring Alarm Debouncing](#), on page 162, for more details on alarms and their configuration.

As part of the alarm calibration process, you can specify that the alarm, when triggered, be sent as an SNMP trap.

### To choose the traps that will be sent to the selected trap targets for this system

- 1 In the main window, click the **System** tab, and then click **Description/Calibrations** on the second-level tab bar.  
A hierarchical list representing the current system appears.
- 2 Expand the multiviewer whose traps you wish to enable, navigate to the appropriate alarm, and then click the alarm to select it.

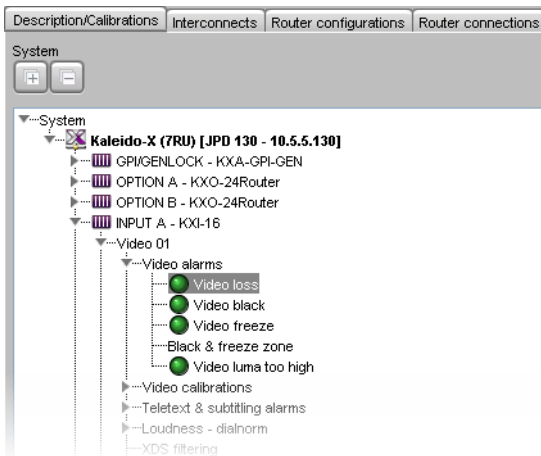

- 3 In the **Properties** pane, select the **Trap enabled** check box to have the multiviewer issue an SNMP trap each time this alarm is triggered.



- 4 Click **Apply to all** to apply this setting to *all other alarms with the same name*, throughout the system.

In the example, clicking **Apply to all** will enable Video Loss SNMP traps for every input in your system. This is particularly useful for audio input errors, because of the large number of channels arriving at the multiviewer.

- 5 Repeat the procedure until all desired SNMP traps have been enabled.
- 6 On the **File** menu, click **Save**.



# 7 Logical Sources

This chapter explain how to configure logical sources for your multiviewer system.

## Key Concepts

Term	Description
Logical source	<p>A <i>logical source</i> (called a <i>channel</i>, in earlier versions of the Kaleido-X software user interface, and related documentation) refers to a group of physical audio, video, or metadata sources, and text attributes. A logical source can be used as a whole, and assigned to a virtual monitor. The Kaleido-X software supports 7000 logical sources.</p> <p>Notes</p> <ul style="list-style-type: none"><li>• The KMV-3901/3911, Kaleido-MX and Kaleido-Modular-X do not yet support more than 1500 logical sources.</li><li>• Kaleido-IP X310 and Kaleido-IP X110 multiviewers support 6000 logical sources. In the case of the Kaleido-IP X300, to support more than 1500 sources, the multiviewer's RAM must be upgraded to 24 GB. Refer to the "Kaleido-IP X300 Memory Modules" section, in the Kaleido-X Release Notes, for installation instructions. The Kaleido-IP X100 is limited to 1500 sources.</li><li>• If you choose to configure your multiviewer system with a large number of logical sources (i.e., more than 1500), you should disable global alarm contribution for all alarm levels in the sources table (see <a href="#">Global Alarms</a>, on page 155), to improve the system performance.</li></ul>
Level	<p>Within a logical source, attributes are organized by <i>levels</i> belonging to either of the following categories: Source info, Video, Audio, Text, Alarm, Time code, and Color. For example, the video level category may comprise multiple levels, each representing a specific physical part of a video signal.</p>
Incremental copy	<p>Once a logical source (channel) is configured, it is possible to use incremental copy to automatically propagate appropriate physical assignments to other adjacent logical sources. For instance, if the current logical source's levels are assigned from Video 1, then the incremental copy tool will automatically assign corresponding physical elements from Video 2 to the next logical source's levels, and so on. Alternatively, if only one or a few specific levels are to be similarly configured, it is possible to use incremental copy on the corresponding level column only.</p>
Incremental copy handle	<p>In the sources table, the incremental copy handle is indicated by a small square  at the bottom right of the selected cell.</p>

## Detailed Directions

### Creating and Configuring Logical Sources

When opening XEdit in offline mode, the initial database is populated with the default configuration for a Kaleido-X (7RU) system, including a fully-populated frame (all cards present) and a set of predefined logical sources. The *KX Router* logical router is also created as a 96 × 80 router where the 96 inputs are the multiviewer's logical sources, the first 48 outputs are those from the two router cards, and the last 32 outputs are monitor wall destinations.

Likewise, when you replace the initial Kaleido-X (7RU) with the appropriate multiviewer model that matches your actual system, you can choose to have your local database populated with a default set of logical sources and a preconfigured *KX Router* logical router.

### Automatically Adding Logical Sources

A set of logical sources based on external video router sources or on multiviewer inputs can be added to the sources table, as a single operation, by clicking **Create logical sources** on the menu that appears when you right-click supported elements in the filtered system list. From the same menu, you can also enable automatic sources creation, which means that the logical sources associated with the selected element will be kept in sync with the corresponding external sources. For example, when sources are added or modified in a router's own configuration environment, logical sources will be added or updated automatically in the multiviewer's sources table.

Alternatively, in the case of a Kaleido-IP, a set of logical sources is also automatically created if you import the stream lineup from a spreadsheet file (see [Importing a stream lineup](#), on page 95).

This section explains how to add logical sources for transport stream sources in the context of a Kaleido-IP multiviewer system. The same procedure applies to all types of multiviewer inputs, including inputs from upstream routers.

### To define logical sources for a transport stream

- 1 In the main window, click the **Channels/Sources** tab.

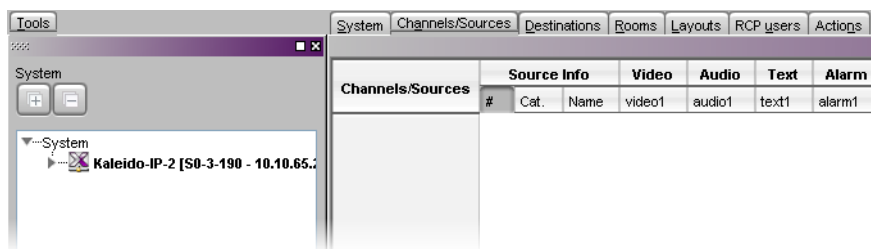

- 2 In the **Tools** pane, expand the multiviewer, and navigate to the transport stream for which you wish to define logical sources.
- 3 Right-click the transport stream, and then click **Create logical sources** on the menu.

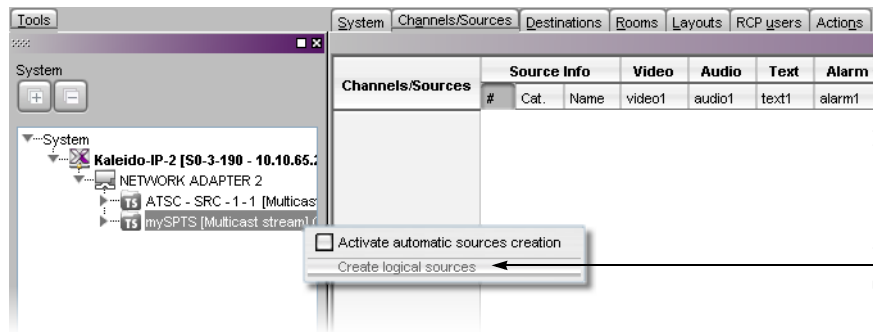

Logical sources are automatically created for every program signal found in the selected transport stream.

Channels/Sources	Source Info			Video	Audio	Program Number
	#	Cat.	Name	video1	audio1	
mySPTS/PG-NUM1		mySPTS	PG-NUM1	PG-NUM:1 ES-IDX:1	PG-NUM:1 ES-PID:52	PG-Num: 1

#### Notes

- Under **Source info**, dynamic and static names resulting from the **Name** level assignments are limited to 48 characters and automatically truncated as needed.
- In the case of a Kaleido-IP system, *do not* select **Activate automatic sources creation**.
- If the case of router sources, if the router is subject to frequent dimension changes, then you may want to select **Activate automatic sources creation**.

- 4 Repeat until you have added logical sources for every stream you wish to monitor.
- 5 If your system involves a control panel from which you will control your multiviewer as a router, then configure source numbers for the *KX Router* logical router, by typing the appropriate numbers in the first column (#) under **Source info**, and using the incremental copy tool as needed.

Channels/Sources	Source Info			Video
	#	Cat.	Name	video1
/ATSC - SRC - 1/PG-NUM2	1	ATSC - SRC - 1	PG-NUM2	PG-NUM:1 ES-IDX:1
/ATSC - SRC - 1/PG-NUM3	2	ATSC - SRC - 1	PG-NUM3	PG-NUM:1 ES-IDX:1
/ATSC - SRC - 1/PG-NUM4	3	ATSC - SRC - 1	PG-NUM4	PG-NUM:1 ES-IDX:1
/ATSC - SRC - 1/PG-NUM6	4	ATSC - SRC - 1	PG-NUM6	PG-NUM:1 ES-IDX:1
/ATSC - SRC - 1/PG-NUM7	5	ATSC - SRC - 1	PG-NUM7	PG-NUM:1 ES-IDX:1

- 6 On the **File** menu, click **Save**.

## Managing Logical Sources Associated with Programs in a Transport Stream

In the case of a Kaleido-IP system, you may need to add or remove sources, from time to time, when programs are added or removed from a transport stream.

### Adding logical sources for new programs in a transport stream

#### To add a logical source for a new program in a transport stream

- 1 Connect XEdit to the Kaleido-IP (see [Using XEdit Online](#), on page 75), and then click the **Channels/Sources** tab.

- 2 In the **Tools** pane, navigate to the transport stream that includes the new program.
- 3 Right-click the program, and then click **Create logical sources** on the menu.

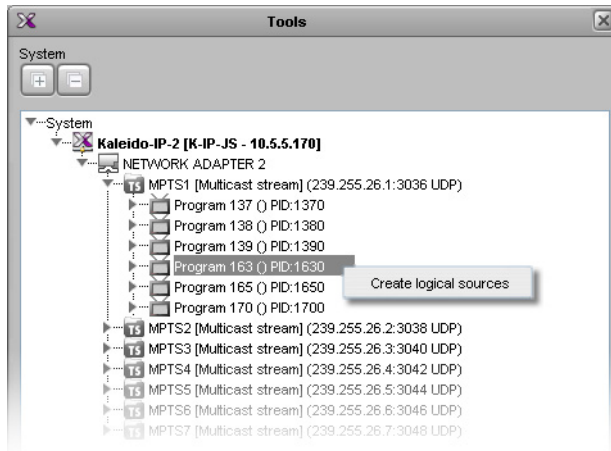

A new entry appears in the sources table, with all assignments based on the logical source template (see [Defining Physical Assignments](#), on page 185).

**Note:** Under **Source info**, dynamic and static names resulting from the **Name** level assignments are limited to 48 characters and automatically truncated as needed.

- 4 On the **File** menu, click **Save**.

### Removing logical sources for removed programs in a transport stream

To remove logical sources associated with programs that are not present anymore

- 1 Connect XEdit to the Kaleido-IP (see [Using XEdit Online](#), on page 75) and then click the **Channels/Sources** tab.

Logical sources associated with programs that have been removed from a transport stream will have elements marked in red.

System Channels/Sources Destinations Rooms Layouts RCP users Actions					
Channels/Sources	Source info			Video	Audio
	#	Cat.	Name	video1	audio1
MPTS1	1		MPTS1	PG-IDX:2 ES-IDX:1	PG-IDX:2 ES-IDX:1
MPTS2	2		MPTS2	PG-IDX:2 ES-IDX:1	PG-IDX:2 ES-IDX:1
MPTS3	3		MPTS3	PG-IDX:2 ES-IDX:1	PG-IDX:2 ES-IDX:1
MPTS4	4		MPTS4	PG-IDX:1 ES-IDX:1	PG-IDX:1 ES-IDX:1
MPTS5	5		MPTS5	PG-IDX:3 ES-IDX:1	PG-IDX:3 ES-IDX:1
MPTS6	6		MPTS6	PG-IDX:5 ES-IDX:1	PG-IDX:5 ES-IDX:1
MPTS7	7		MPTS7	PG-IDX:7 ES-IDX:1	PG-IDX:7 ES-IDX:1
SPTS1	8		SPTS1	PG-IDX:1 ES-IDX:1	PG-IDX:1 ES-IDX:1
SPTS2	9		SPTS2	PG-IDX:1 ES-IDX:1	PG-IDX:1 ES-IDX:1
SPTS3	10		SPTS3	PG-IDX:1 ES-IDX:1	PG-IDX:1 ES-IDX:1
SPTS4	11		SPTS4	PG-IDX:1 ES-IDX:1	PG-IDX:1 ES-IDX:1
SPTS5	12		SPTS5	PG-IDX:1 ES-IDX:1	PG-IDX:1 ES-IDX:1
SPTS6	13		SPTS6	PG-IDX:1 ES-IDX:1	PG-IDX:1 ES-IDX:1

- 2 Select these sources (using the standard Shift+click or Ctrl+click keyboard shortcuts to extend your selection as needed).
- 3 Right-click the selection, and then click **Delete selected sources** on the menu.



System Channels/Sources Destinations Rooms Layouts RCP users Actions						
Channels/Sources	Source info			Video	Audio	
	#	Cat.	Name	video1	audio1	
MPTS1	1		MPTS1	PG-IDX:2 ES-IDX:1	PG-IDX:2 ES-IDX:1	
MPTS2	2		MPTS2	PG-IDX:2 ES-IDX:1	PG-IDX:2 ES-IDX:1	
MPTS3	3		MPTS3	PG-IDX:2 ES-IDX:1	PG-IDX:2 ES-IDX:1	
MPTS4	4		MPTS4	PG-IDX:1 ES-IDX:1	PG-IDX:1 ES-IDX:1	
MPTS5	5		MPTS5	PG-IDX:3 ES-IDX:1	PG-IDX:3 ES-IDX:1	
MPTS6	6		MPTS6	PG-IDX:5 ES-IDX:1	PG-IDX:5 ES-IDX:1	
MPTS7	7		MPTS7	PG-IDX:7 ES-IDX:1	PG-IDX:7 ES-IDX:1	
SPTS1	8		SPTS1	PG-IDX:1 ES-IDX:1	PG-IDX:1 ES-IDX:1	
SPTS2				PG-IDX:1 ES-IDX:1	PG-IDX:1 ES-IDX:1	
SPTS3				PG-IDX:1 ES-IDX:1	PG-IDX:1 ES-IDX:1	
SPTS4				PG-IDX:1 ES-IDX:1	PG-IDX:1 ES-IDX:1	
SPTS5				PG-IDX:1 ES-IDX:1	PG-IDX:1 ES-IDX:1	
SPTS6				PG-IDX:1 ES-IDX:1	PG-IDX:1 ES-IDX:1	

Add source

Delete selected sources

Set source as template

Apply template to all sources

Apply template to selected sources

- 4 On the **File** menu, click **Save**.
- 5 Click the **Layouts** tab, open the appropriate layouts, locate any monitors that included assignments based on the sources you just deleted, and update their configuration as required (see [Assigning Logical Sources](#) or [Monitor Wall Destinations to Monitors](#), on page 232).

## Manually adding a Logical Source

### To add a logical source

- 1 Click the **Channels/Sources** tab in the main window.

The sources table appears.

System Channels/Sources Destinations Rooms Layouts RCP users Actions											
Channels/Sources	Source info			Video	Audio	Text	Alarm	Time code	Color		
	#	Cat.	Name	video1	audio1	text1	Loss	timecode1	color1		
Input A/Channel 01	1	Input A	Channel 01	A01	A01 Emb 1	InputA-video1	A01 Video loss	A01 Vid. TC			
Input A/Channel 02	2	Input A	Channel 02	A02	A02 Emb 1	InputA-video2	A02 Video loss	A02 Vid. TC			
Input A/Channel 03	3	Input A	Channel 03	A03	A03 Emb 1	InputA-video3	A03 Video loss	A03 Vid. TC			
Input A/Channel 04	4	Input A	Channel 04	A04	A04 Emb 1	InputA-video4	A04 Video loss	A04 Vid. TC			
Input A/Channel 05	5	Input A	Channel 05	A05	A05 Emb 1	InputA-video5	A05 Video loss	A05 Vid. TC			
Input A/Channel 06	6	Input A	Channel 06	A06	A06 Emb 1	InputA-video6	A06 Video loss	A06 Vid. TC			
Input A/Channel 07	7	Input A	Channel 07	A07	A07 Emb 1	InputA-video7	A07 Video loss	A07 Vid. TC			
Input A/Channel 08	8	Input A	Channel 08	A08	A08 Emb 1	InputA-video8	A08 Video loss	A08 Vid. TC			
Input A/Channel 09	9	Input A	Channel 09	A09	A09 Emb 1	InputA-video9	A09 Video loss	A09 Vid. TC			
Input A/Channel 10	10	Input A	Channel 10	A10	A10 Emb 1	InputA-video10	A10 Video loss	A10 Vid. TC			
Input A/Channel 11	11	Input A	Channel 11	A11	A11 Emb 1	InputA-video11	A11 Video loss	A11 Vid. TC			
Input A/Channel 12	12	Input A	Channel 12	A12	A12 Emb 1	InputA-video12	A12 Video loss	A12 Vid. TC			
Input A/Channel 13	13	Input A	Channel 13	A13	A13 Emb 1	InputA-video13	A13 Video loss	A13 Vid. TC			
Input A/Channel 14	14	Input A	Channel 14	A14	A14 Emb 1	InputA-video14	A14 Video loss	A14 Vid. TC			
Input A/Channel 15	15	Input A	Channel 15	A15	A15 Emb 1	InputA-video15	A15 Video loss	A15 Vid. TC			
Input A/Channel 16	16	Input A	Channel 16	A16	A16 Emb 1	InputA-video16	A16 Video loss	A16 Vid. TC			
Input B/Channel 01	17	Input B	Channel 01	B01	B01 Emb 1	InputB-video1	B01 Video loss	B01 Vid. TC			
Input B/Channel 02	18	Input B	Channel 02	B02	B02 Emb 1	InputB-video2	B02 Video loss	B02 Vid. TC			
Input B/Channel 03	19	Input B	Channel 03	B03	B03 Emb 1	InputB-video3	B03 Video loss	B03 Vid. TC			
Input B/Channel 04	20	Input B	Channel 04	B04	B04 Emb 1	InputB-video4	B04 Video loss	B04 Vid. TC			

**Note:** The sources table is preconfigured with a set of default assignments, including at least one level under each level category. A symbol indicates the physical source for each assignment: for example, "A16" indicates input signal 16 on input card A. In the case of an expansion system, the symbol is prefixed with a frame identifier: either "FRA-" or "FRB-". On the Kaleido-X16, only the input numbers 01 to 16 appear. On a KMV-3901/3911, the input numbers 1 to 8 (or 1 to 4, in the case of the 4 × 1 and 4 × 2 models) appear.

2 On the **File** menu, click **New**.

Alternatively right-click the **Channels/Sources** column heading, and then click **Add source** on the menu.

System Channels/Sources Destinations Rooms Layouts RCP users Actions						
Channels/Sources	Source info		Video	Audio	Text	
	#	Cat	Name	video1	audio1	text1
Input A/Channel 0		Sort	Channel 01	A01	A01 Emb 1	InputA-video1
Input A/Channel 0		Add source	Channel 02	A02	A02 Emb 1	InputA-video2
Input A/Channel 03	3	Input A	Channel 03	A03	A03 Emb 1	InputA-video3
Input A/Channel 04	4	Input A	Channel 04	A04	A04 Emb 1	InputA-video4
Input A/Channel 05	5	Input A	Channel 05	A05	A05 Emb 1	InputA-video5
Input A/Channel 06	6	Input A	Channel 06	A06	A06 Emb 1	InputA-video6

A logical source is added at the bottom of the sources table.

Input F/Channel 10	90	Input F	Channel 10	F10	F10 Emb 1	InputF-video10	F10 Vid. TC
Input F/Channel 11	91	Input F	Channel 11	F11	F11 Emb 1	InputF-video11	F11 Vid. TC
Input F/Channel 12	92	Input F	Channel 12	F12	F12 Emb 1	InputF-video12	F12 Vid. TC
Input F/Channel 13	93	Input F	Channel 13	F13	F13 Emb 1	InputF-video13	F13 Vid. TC
Input F/Channel 14	94	Input F	Channel 14	F14	F14 Emb 1	InputF-video14	F14 Vid. TC
Input F/Channel 15	95	Input F	Channel 15	F15	F15 Emb 1	InputF-video15	F15 Vid. TC
Input F/Channel 16	96	Input F	Channel 16	F16	F16 Emb 1	InputF-video16	F16 Vid. TC
Channel1			Channel1				

**Notes**

- Under **Source info**, you can change the logical source name and path, resulting from the **Name** and **Cat.** level assignments. For example, “Channel 1” can be renamed “Cam 1” or assigned a dynamic name. You can group related logical sources together, by adding static or dynamic text elements to the **Cat.** level, and then sorting the table as needed, to suit your purposes (see [Sorting the Sources Table](#), on page 190). You can also apply a filter to the table, so that sources that do not match the filter be hidden from view (see [Filtering the Sources Table](#), on page 191).
- When a logical source’s name or category changes, the row header is updated accordingly.
- When applying an *overall* incremental copy (from the row header), the **Source info** columns and the Video levels are excluded. These columns must be incremented individually. The overall incremental copy features relies on a video level having been populated first.

3 On the **File** menu, click **Save**.

The sources table is saved.

**Managing Levels**

**Adding a level**

**Note:** To be able to monitor a 3D stereoscopic signal, you must first add a second video level to your logical sources (so you have a level for each eye), and then for each video monitor or composite you wish to use for 3D monitoring, you must assign the left-eye and right-eye levels.

## To add a level

- 1 Click the **Channels/Sources** tab in the main window.

The level categories Video, Audio, Text, Alarm, Time code, and Color appear as main column headings in the sources table.

System Channels/Sources Destinations Rooms Layouts RCP users Actions										
Channels/Sources	Source info			Video	Audio	Text	Alarm	Time code	Color	← Level categories
	#	Cat.	Name	video1	audio1	text1	alarm1	timecode1	color1	
Input A/Channel 01	1	Input A	Channel 01	A01	A01 Emb 1	InputA-video1	A01 Video loss	A01 Vid. TC		
Input A/Channel 02	2	Input A	Channel 02	A02	A02 Emb 1	InputA-video2	A02 Video loss	A02 Vid. TC		
Input A/Channel 03	3	Input A	Channel 03	A03	A03 Emb 1	InputA-video3	A03 Video loss	A03 Vid. TC		
Input A/Channel 04	4	Input A	Channel 04	A04	A04 Emb 1	InputA-video4	A04 Video loss	A04 Vid. TC		
Input A/Channel 05	5	Input A	Channel 05	A05	A05 Emb 1	InputA-video5	A05 Video loss	A05 Vid. TC		
Input A/Channel 06	6	Input A	Channel 06	A06	A06 Emb 1	InputA-video6	A06 Video loss	A06 Vid. TC		

- 2 Right-click the appropriate level category, and then click **Add level** on the menu.

Add level

Channels/Sources	Source info			Video	Audio	Text	Alarm	Time code	Color
	#	Cat.	Name	video1	audio1	text1	alarm1	timecode1	color1
Input A/Channel 01	1	Input A	Channel 01	A01	A01 Emb 1	InputA-video1	A01 Video loss	A01 Vid. TC	
Input A/Channel 02	2	Input A	Channel 02	A02	A02 Emb 1	InputA-video2	A02 Video loss	A02 Vid. TC	
Input A/Channel 03	3	Input A	Channel 03	A03	A03 Emb 1	InputA-video3	A03 Video loss	A03 Vid. TC	
Input A/Channel 04	4	Input A	Channel 04	A04	A04 Emb 1	InputA-video4	A04 Video loss	A04 Vid. TC	
Input A/Channel 05	5	Input A	Channel 05	A05	A05 Emb 1	InputA-video5	A05 Video loss	A05 Vid. TC	
Input A/Channel 06	6	Input A	Channel 06	A06	A06 Emb 1	InputA-video6	A06 Video loss	A06 Vid. TC	

A new level appears under the selected category.

Channels/Sources	Source info			Video	Audio	Text	Alarm	Time code	Color	
	#	Cat.	Name	video1	audio1	text1	text2	alarm1	timecode1	color1
Input A/Channel 01	1	Input A	Channel 01	A01	A01 Emb 1	InputA-video1		A01 Video loss	A01 Vid. TC	
Input A/Channel 02	2	Input A	Channel 02	A02	A02 Emb 1	InputA-video2		A02 Video loss	A02 Vid. TC	
Input A/Channel 03	3	Input A	Channel 03	A03	A03 Emb 1	InputA-video3		A03 Video loss	A03 Vid. TC	
Input A/Channel 04	4	Input A	Channel 04	A04	A04 Emb 1	InputA-video4		A04 Video loss	A04 Vid. TC	
Input A/Channel 05	5	Input A	Channel 05	A05	A05 Emb 1	InputA-video5		A05 Video loss	A05 Vid. TC	
Input A/Channel 06	6	Input A	Channel 06	A06	A06 Emb 1	InputA-video6		A06 Video loss	A06 Vid. TC	

- 3 If you wish to change the level name, click the level header, and then, in the **Properties** pane, type the new name in the **Level name** box.

In the case of an alarm level, you may also set its contribution to your system's global alarms. See [Configuring an alarm level's contribution](#) below.

- 4 On the **File** menu, click **Save**.

The sources table is saved.

## Configuring an alarm level's contribution

You can select which alarm levels contribute to the global alarm associated with every logical source (see [Global Alarms](#), on page 155), and rank their individual contribution.

### To configure an alarm level's contribution to your system's global alarms

- In the sources table, click the column header for the level you wish to configure. The **Properties** pane shows the name of the selected alarm level, and its current contribution settings.

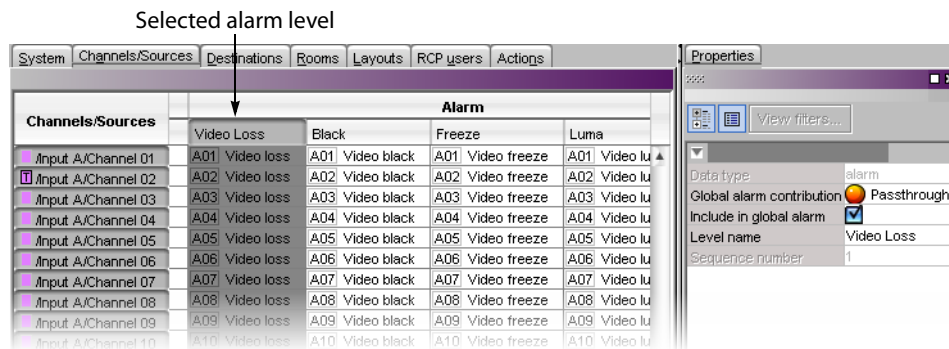

- If you wish to exclude alarms in this level from the global alarm calculation, then clear the **Include in global alarm** check box.
- To rank this level's contribution to your system's global alarms, click the **Global alarm contribution** box, and then select the appropriate value from the list.

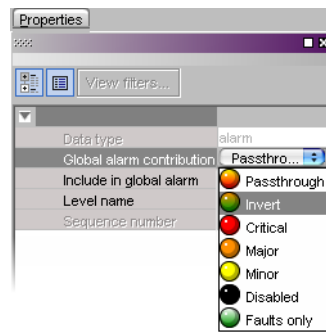

- **Passthrough:** This is the default value. Alarms in this level will pass their status unaltered to the global alarms.
- **Critical, Major, Minor, Disabled:** It is possible to override the error status of alarms when they are triggered. This is useful when, for example, a device is only able to report a status of either normal or error, but you want the error condition to be considered as minor in the global alarm calculation.
- **Invert:** Alarms in this level will pass the opposite of their status to the global alarms. This can be used, for example, to report alarms from GPI inputs, or to handle cases where an error is expected, and not seeing an error is a sign that something probably went wrong. The table below describes the result of inverting sub-alarms:

Alarm status	Inverted contribution
NORMAL	ERROR
MINOR	NORMAL
MAJOR	NORMAL
CRITICAL	NORMAL
NON-EXISTENT	NON-EXISTENT
PENDING	PENDING

Alarm status	Inverted contribution
DISABLED	DISABLED
UNKNOWN	UNKNOWN

- **Faults only:** Alarms in this level will be mapped to normal unless their status is one of the fault statuses—usually critical, major, and minor.<sup>2</sup>

## Defining Physical Assignments

Once you have created a logical source, you must make the physical assignments. This is required before you can create a layout.

### To make the physical assignments for a logical source

- 1 In the sources table, click the cell that corresponds to the level you wish to define for this logical source.
- 2 In the **Tools** pane, expand the filtered System list, and then drag the appropriate element from the list, to the selected level in the sources table.

For a typical logical source, you will normally start by making a video assignment, set the appropriate category and source ID (under **Source info**) if you wish to control your multiviewer system as a router, and then proceed with the audio, text, alarm, time code, and color levels. See, for example, [Configuring text level assignments](#), on page 186, [Configuring alarm level assignments](#), on page 186, [Configuring logical sources based on external alarm providers](#), on page 187, and [Configuring color level assignments](#), on page 188.

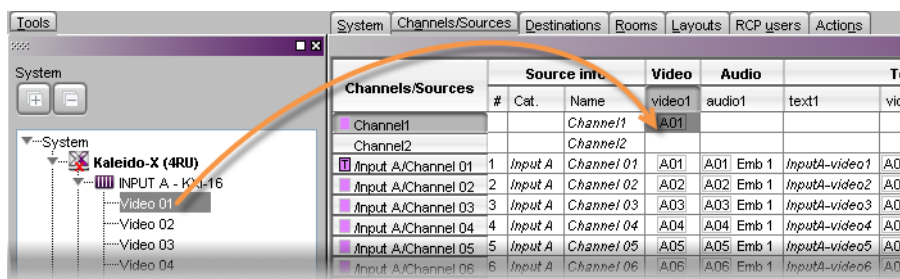

Sources table with a selected cell in the Video level category for Channel1

- 3 Repeat the procedure until all desired physical assignments are completed for this logical source.

**Note:** Under **Source info**, dynamic and static names resulting from the **Name** level assignments are limited to 48 characters and automatically truncated as needed.

- 4 If you wish to be able to use this logical source as a template, right-click the source header and then click **Set source as template** on the menu.

<sup>2</sup>The list of fault status can be modified by scripting.

System Channels/Sources Destinations Rooms Layouts RCP users Actions						
Channels/Sources	Info	Video	Audio	Text	Alarm	
Name	video1	audio1	text1	alarm1	timecode1	
<input type="checkbox"/> Input A/Channel 01	Channel 01	A01	A01 Emb 1	Input-video1	A01 Video loss	A01 Vid. TC
<input type="checkbox"/> Input A/Channel 02	Add source			Input-video2	A02 Video loss	A02 Vid. TC
<input type="checkbox"/> Input A/Channel 03	Delete selected sources			Input-video3	A03 Video loss	A03 Vid. TC
<input type="checkbox"/> Input A/Channel 04	Set source as template			Input-video4	A04 Video loss	A04 Vid. TC
<input type="checkbox"/> Input A/Channel 05	Apply template to all sources			Input-video5	A05 Video loss	A05 Vid. TC
<input type="checkbox"/> Input A/Channel 06	Apply template to selected sources			Input-video6	A06 Video loss	A06 Vid. TC
<input type="checkbox"/> Input A/Channel 07				Input-video7	A07 Video loss	A07 Vid. TC
<input type="checkbox"/> Input A/Channel 08	Channel 08	A08	A08 Emb 1	Input-video8	A08 Video loss	A08 Vid. TC
<input type="checkbox"/> Input A/Channel 09	Channel 09	A09	A09 Emb 1	Input-video9	A09 Video loss	A09 Vid. TC
<input type="checkbox"/> Input A/Channel 10	Channel 10	A10	A10 Emb 1	Input-video10	A10 Video loss	A10 Vid. TC

Once you have added the required number of logical sources, and made appropriate video assignments, you will be able to populate remaining levels in a single operation by applying the template. If you have enabled automatic sources creation for an external router, then automatically-created logical sources will be based on the template.

### Configuring text level assignments

#### To assign a text element to a logical source's text level

- 1 Click the **Channels/Sources** tab in the main window.
- 2 In the sources table, click the cell that corresponds to the logical source and text level you wish to configure.
- 3 Expand the filtered System list in the **Tools** pane, locate the text element, and then drag it onto the selected cell in the sources table.

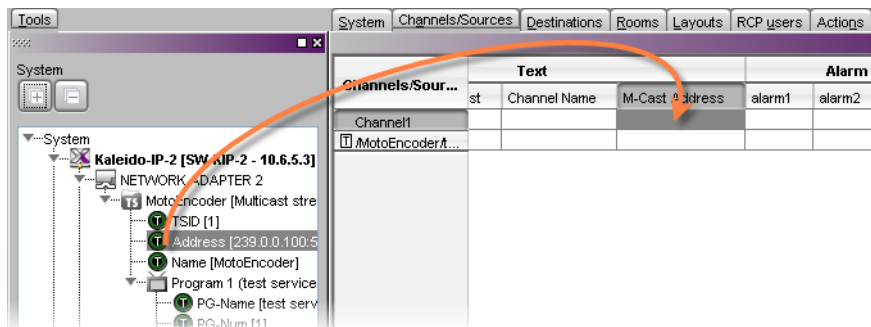

**Note:** Under **Source info**, dynamic and static names resulting from the **Name** level assignments are limited to 48 characters and automatically truncated as needed.

- 4 On the **File** menu, click **Save**.  
The sources table is saved.

### Configuring alarm level assignments

#### To assign an alarm to a logical source's alarm level

- 1 Click the **Channels/Sources** tab in the main window.
- 2 In the sources table, click the cell that corresponds to the logical source and alarm level you wish to configure.

- Expand the filtered System list in the **Tools** pane, locate the alarm, and drag it onto the selected cell in the sources table.

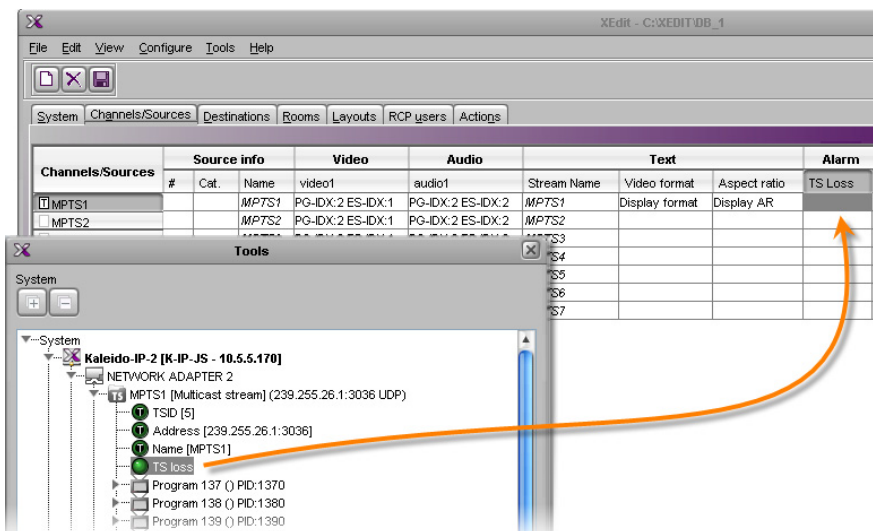

- On the **File** menu, click **Save**.  
The sources table is saved.

### Configuring logical sources based on external alarm providers

To have access to alarms and text elements from an external alarm provider, you must have specified this provider in your multiviewer system configuration (see [Managing Alarm Providers](#), on page 163).

#### To assign an alarm or a text element from an external provider

- Open a GSM alarm browser associated with the alarm provider you wish to use.  
For example, after opening iControl Navigator, click **General status managers** on the **View** menu. Refer to the iControl User Guide for more information.
- In XEdit, click the **Channels/Sources** tab in the main window.
- In the GSM alarm browser, navigate to the element you wish to assign, and then drag it onto the cell that corresponds to the alarm or text level you wish to configure in the sources table.

In the selected cell, the prefix "EXT" indicates that the assignment is from an external source and is followed with information such as the device class and a name.

---

#### Notes

- You can select multiple elements in the GSM alarm browser (by pressing Shift+click or Ctrl+click as needed) and assign them to consecutive logical sources at once, by dragging the multiple selection to the appropriate level for the first logical source you wish to configure. The elements are inserted in the same order you selected them.
  - Drag an alarm folder to an alarm level to monitor the folder's status. Dragging an alarm folder to a text level is not supported.
  - GSM alarms are not available as triggers for background actions (see [Creating Background Actions](#), on page 304).
  - Incremental copy is not supported in the case of assignments from external providers (see [Making Further Assignments by Incremental Copy](#), below).
- 

- 4 On the **File** menu, click **Save**.  
The sources table is saved.

### Configuring color level assignments

You may configure sources with color levels so that you can distinguish them at a glance on the monitor wall. For example, your sources could have three color levels: one that you would apply to a monitor's border color, one to a UMD's background, and one to the UMD text.

#### To configure a logical source's color levels

- 1 Click the **Channels/Sources** tab in the main window.
- 2 In the sources table, double-click the cell that corresponds to the logical source and color level you wish to configure.  
The color picker window opens.
- 3 In **Colors**, click the tab that corresponds to the color space you wish to use, and then choose the color that will be associated with the selected source and color level.



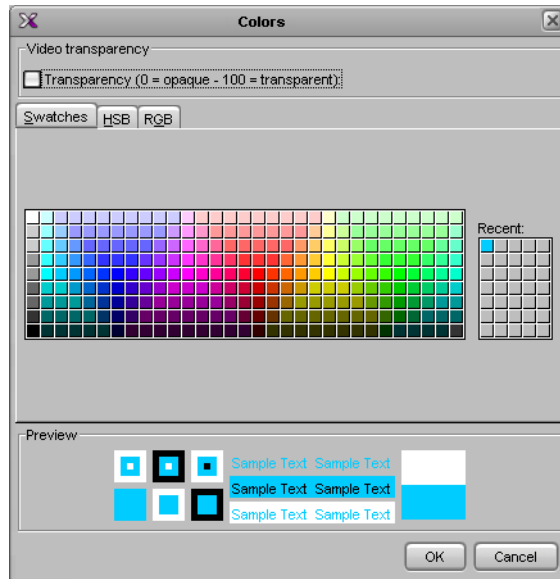

- Click **OK** to close the color picker window.  
The color you chose appears in the sources table.

Channels/Sources	Source info			Video	Audio	Text	Alarm	Time code	Color
	#	Cat.	Name	video1	audio1	text1	Loss	timecode1	color1
Input A/Channel 01	1	Input A	Channel 01	A01	A01 Emb 1	InputA-video1	A01 Video loss	A01 Vid. TC	R:0 G:204 B:255
Input A/Channel 02	2	Input A	Channel 02	A02	A02 Emb 1	InputA-video2	A02 Video loss	A02 Vid. TC	
Input A/Channel 03	3	Input A	Channel 03	A03	A03 Emb 1	InputA-video3	A03 Video loss	A03 Vid. TC	

- Repeat from [step 2](#) until you have configured all color levels for this source.
- On the **File** menu, click **Save**.  
The sources table is saved.

### Making Further Assignments by Incremental Copy

Once done with a first logical source, if the next logical source is to be similar to the first one, it is possible to use incremental copy to automatically create it. Alternatively, if only one or a few specific levels are to be similarly configured, it is possible to use incremental copy on the corresponding level column only.

---

Note: Color levels are not subject to incremental copy.

---

### To use the incremental copy tool to propagate physical assignments to adjacent logical sources

- Click the row header for the logical source whose assignments you wish to propagate.  
A small square, the *incremental copy handle*, appears in the bottom right corner of the header cell.

System Channels/Sources Destinations Rooms Layouts RCP_users Actions						
Channels/Sources		Video	Audio	Text	Alarm	Time code
	Source ID	video1	audio1	text1	alarm1	timecode1
/Input A/Channel 14	14	A14	A14 Emb 1	InputA-video14		A14 Vid. TC
/Input A/Channel 15	15	A15	A15 Emb 1	InputA-video15		A15 Vid. TC
/Input A/Channel 16	16	A16	A16 Emb 1	InputA-video16		A16 Vid. TC
/Input B/Channel 01	17	B01	B01 Emb 1	InputB-video1		B01 Vid. TC
/Input B/Channel 02						
/Input B/Channel 03						

Incremental copy handle

- 2 Move the pointer to the incremental copy handle. The pointer changes to crosshairs.

Channels/Sources		Video	Audio	Text	Alarm	Time code
	Source ID	video1	audio1	text1	alarm1	timecode1
/Input A/Channel 13	13	A13	A13 Emb 1	InputA-video13		A13 Vid. TC
/Input A/Channel 14	14	A14	A14 Emb 1	InputA-video14		A14 Vid. TC
/Input A/Channel 15	15	A15	A15 Emb 1	InputA-video15		A15 Vid. TC
/Input A/Channel 16	16	A16	A16 Emb 1	InputA-video16		A16 Vid. TC
/Input B/Channel 01	17	B01	B01 Emb 1	InputB-video1		B01 Vid. TC
/Input B/Channel 02						
/Input B/Channel 03						
/Input B/Channel 04						
/Input B/Channel 05						
/Input B/Channel 06						

- 3 Click and drag to propagate the selected logical source's physical assignments to the next logical sources' levels. The source cells are highlighted with a green border and the target cells with a red border.

/Input A/Channel 15	15	A15	A15 Emb 1	InputA-video15		A15 Vid. TC
/Input A/Channel 16	16	A16	A16 Emb 1	InputA-video16		A16 Vid. TC
/Input B/Channel 01	17	B01	B01 Emb 1	InputB-video1		B01 Vid. TC
/Input B/Channel 02						
/Input B/Channel 03						
/Input B/Channel 04						
/Input B/Channel 05						
/Input B/Channel 06						
/Input B/Channel 07						

- 4 Release the mouse button once you have reached the last logical source to be configured.

The level cells are now populated with "incremented" physical assignments.

/Input A/Channel 14	14	A14	A14 Emb 1	InputA-video14		A14 Vid. TC
/Input A/Channel 15	15	A15	A15 Emb 1	InputA-video15		A15 Vid. TC
/Input A/Channel 16	16	A16	A16 Emb 1	InputA-video16		A16 Vid. TC
/Input B/Channel 01	17	B01	B01 Emb 1	InputB-video1		B01 Vid. TC
/Input B/Channel 02	18	B02	B02 Emb 1	InputB-video2		B02 Vid. TC
/Input B/Channel 03	19	B03	B03 Emb 1	InputB-video3		B03 Vid. TC
/Input B/Channel 04	20	B04	B04 Emb 1	InputB-video4		B04 Vid. TC
/Input B/Channel 05	21	B05	B05 Emb 1	InputB-video5		B05 Vid. TC
/Input B/Channel 06	22	B06	B06 Emb 1	InputB-video6		B06 Vid. TC
/Input B/Channel 07	23	B07	B07 Emb 1	InputB-video7		B07 Vid. TC
/Input B/Channel 08						
/Input B/Channel 09						

**Note:** It is possible to drag the incremental copy handle up, or down. The physical assignments will be decremented or incremented accordingly.

## Sorting the Sources Table

### To sort the sources table

- Right-click the heading of the column you wish to sort by (i.e. either **Source ID**, or any of the level headings), and then click **Sort** on the menu.

System Channels/Sources Destinations Rooms Layouts RCP users Actions						
Channels/Sources	Source ID	Video	Audio	Text	Alarm	Time code
		video1	audio1	text1	alarm1	timecode1
/Input A/Channel 01	1	A01	Sort	InputA-video1		A01 Vid. TC
/Input A/Channel 03	3	A03	Delete level	InputA-video3		A03 Vid. TC
/Input A/Channel 04	4	A04		InputA-video4		A04 Vid. TC
/Input A/Channel 02	2	A02	A02 Emb 1	InputA-video2		A02 Vid. TC
/Input A/Channel 05	5	A05	A05 Emb 1	InputA-video5		A05 Vid. TC
/Input A/Channel 06	6	A06	A06 Emb 1	InputA-video6		A06 Vid. TC
/Input A/Channel 07	7	A07	A07 Emb 1	InputA-video7		A07 Vid. TC

The sources table is sorted, based on the elements in the selected level.

## Filtering the Sources Table

To filter the sources table

- Type in the **Cat./Name** filter box, located above the sources table.

Cat./Name filter →

System Channels/Sources Destinations Rooms Layouts RCP users Actions						
Cat./Name filter ...						
Channels/Sources	Source info			Video	Audio	
	#	Cat.	Name	video1	audio1	text1
/Input A/Channel 01	1	Input A	Channel 01	A01	A01 Emb 1	InputA-video1
/Input A/Channel 02	2	Input A	Channel 02	A02	A02 Emb 1	InputA-video2
/Input A/Channel 03	3	Input A	Channel 03	A03	A03 Emb 1	InputA-video3
/Input A/Channel 04	4	Input A	Channel 04	A04	A04 Emb 1	InputA-video4
/Input A/Channel 05	5	Input A	Channel 05	A05	A05 Emb 1	InputA-video5
/Input A/Channel 06	6	Input A	Channel 06	A06	A06 Emb 1	InputA-video6
/Input A/Channel 07	7	Input A	Channel 07	A07	A07 Emb 1	InputA-video7
/Input A/Channel 08	8	Input A	Channel 08	A08	A08 Emb 1	InputA-video8

Logical sources with categories and names that do not match the text or regular expression are hidden as you type.

Filter text →

Example: Type "input f" to view only the sources that belong to Input F.

System Channels/Sources Destinations Rooms Layouts RCP users Actions						
input f						
Channels/Sources	Source info			Video	Audio	
	#	Cat.	Name	video1	audio1	text1
/Input F/Channel 01	81	Input F	Channel 01	F01	F01 Emb 1	InputF-video1
/Input F/Channel 02	82	Input F	Channel 02	F02	F02 Emb 1	InputF-video2
/Input F/Channel 03	83	Input F	Channel 03	F03	F03 Emb 1	InputF-video3
/Input F/Channel 04	84	Input F	Channel 04	F04	F04 Emb 1	InputF-video4
/Input F/Channel 05	85	Input F	Channel 05	F05	F05 Emb 1	InputF-video5
/Input F/Channel 06	86	Input F	Channel 06	F06	F06 Emb 1	InputF-video6
/Input F/Channel 07	87	Input F	Channel 07	F07	F07 Emb 1	InputF-video7
/Input F/Channel 08	88	Input F	Channel 08	F08	F08 Emb 1	InputF-video8
/Input F/Channel 09	89	Input F	Channel 09	F09	F09 Emb 1	InputF-video9
/Input F/Channel 10	90	Input F	Channel 10	F10	F10 Emb 1	InputF-video10
/Input F/Channel 11	91	Input F	Channel 11	F11	F11 Emb 1	InputF-video11
/Input F/Channel 12	92	Input F	Channel 12	F12	F12 Emb 1	InputF-video12
/Input F/Channel 13	93	Input F	Channel 13	F13	F13 Emb 1	InputF-video13
/Input F/Channel 14	94	Input F	Channel 14	F14	F14 Emb 1	InputF-video14
/Input F/Channel 15	95	Input F	Channel 15	F15	F15 Emb 1	InputF-video15
/Input F/Channel 16	96	Input F	Channel 16	F16	F16 Emb 1	InputF-video16

## Notes

- The filter is not applied to new logical sources that have yet to be saved. They will remain visible, until you saved the sources table.
- It is always possible to apply the template source to other logical sources, even when this specific source is hidden.
- Apply template to all sources** affects all logical sources, regardless of filtering.

---

*Notes (continued)*

- The incremental copy tool affects visible sources only.
- 

**Resizing the Sources Table's Columns****To resize a column manually**

- In the category or level heading row, point the column boundary you wish to move until the pointer becomes a resize pointer (↔), and then drag the boundary until the column is the desired width.

**To resize a column to the width of its content**

- In the category or level heading row, point either boundary for the column you wish to resize to fit, until the pointer becomes a resize pointer (↔), and then double-click. The column width is adjusted to fit the content.

**To resize all columns to the width of their content**

- In the category or level heading row, point any column boundary until the pointer becomes a resize pointer (↔), and then triple-click. All columns are resized to fit their content.

---

**Note:** If there are more than 250 rows in the sources tables, when you double- or triple-click, the columns are adjusted to fit the content of the currently visible rows only.

---

**Monitoring Internal-Router Outputs on the Monitor Wall (Sample Scenario)**

It is possible, for specific monitoring purposes, to configure a video monitor so that it displays the current signal at a physical output from the multiviewer's internal router, by assigning this router output to a logical source's video level.

**To configure a monitor to follow an internal-router output on the monitor wall**

- 1 Click the **Channels/Sources** tab in the main window.
- 2 Add a logical source to the table (see [Manually adding a Logical Source](#), on page 181).
- 3 In the new logical source row, click the cell that corresponds to the first video level.
- 4 Expand the filtered System list in the **Tools** pane, locate the router output you wish to monitor, and then drag it onto the selected cell in the sources table.
- 5 On the **File** menu, click **Save**.  
The sources table is saved.
- 6 Click the **Layouts** tab, and open the appropriate layout.
- 7 From the **Channel/Sources** list in the **Tools** pane, drag the new logical source onto the monitor you wish to configure, and then save the layout.

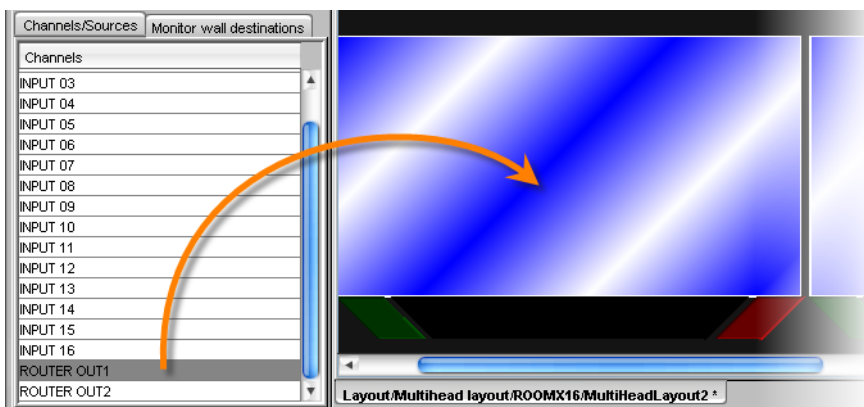

Once such a logical source is available, you can also assign it to other composite or video monitors, directly on the monitor wall, and their video window will dynamically follow the video signal sent to that router output.

---

**Note:** The current version of the Kaleido-X software does not support monitoring of the associated audio signal.

---



# 8

## Setting Up Rooms

This section describes Kaleido-X rooms and their configuration.

### Key Concepts

Term	Description
Room	A room is a visual grouping of displays that represent the physical displays positioned and sized as they are installed in an actual room. Multiple operators can share the same room. The grouping of display creates a large virtual monitor wall that operators see as a single large display. The room definition specifies display resolutions and sizes, as well as zones that are used to display full screen layouts.
Display versus monitor	Within the XEdit workflow, a <i>display</i> refers to the representation of a physical display monitor (such as a CRT) within a room, whereas a <i>monitor</i> represents a physical signal within a layout: for example, a video monitor displaying a specific video signal.
Full screen zone	A full screen zone is a sub-section of a room. It can be any size and it can be positioned on any of the displays in the room. A full screen zone can be associated with one or more full screen layouts assigned to specific users.
Display library	A display library contains a collection of predefined displays that can be conveniently reused to configure your system's rooms. More than one display library can exist.

### Detailed Directions

#### Managing Rooms

In XEdit, a room represents a grouping of displays on the monitor wall driven by your Kaleido-X system. When creating a room, you add displays, and assign each of them an output head. You can also define full screen zones.

---

**Note:** In the case of a cluster system, it is possible to view a room configuration in offline mode. However, to create and configure a room, XEdit must be connected to one of the cluster members (see [Using XEdit Online](#), on page 75).

---

## Creating Rooms

### To create a room

- 1 Click the **Rooms** tab in the main window.
- 2 On the **File** menu, click **New**.  
An empty room with a black background appears in the main window.
- 3 Add the appropriate number of displays and configure them to match your actual installations. See [Adding Displays](#) on page 198, and [Configuring Displays](#), on page 202.
- 4 Optionally add full screen zones (see [Adding Full Screen Zones](#) on page 201).
- 5 On the **File** menu, click **Save**.

The **Save Room** window appears.

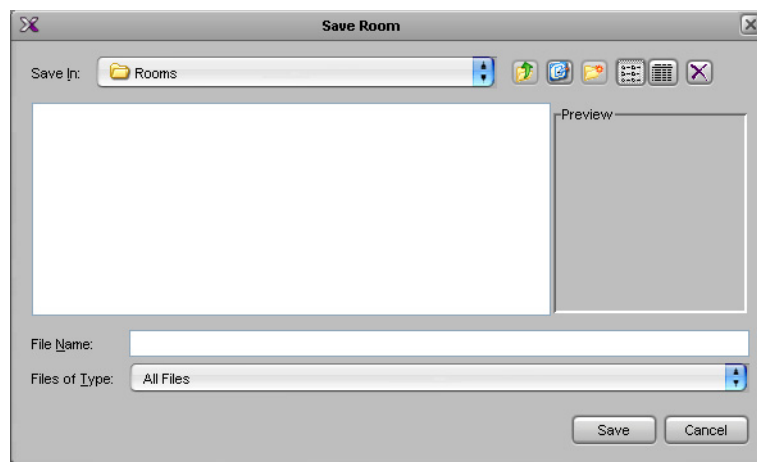

- 6 Type a name for the new room, and then click **Save**.

---

### Notes

- A room name cannot exceed 7 characters.
  - A room can only be saved once every display has been assigned an output head (see [Adding Displays](#), on page 198).
  - In a cluster system, each room must have a unique name across the whole system. XEdit will not let you use a name if there is already a room with this name associated with one of the multiviewers within the cluster.
  - In a cluster system, if one of the member multiviewers becomes unavailable while you were configuring a room, then XEdit will not let you save the room. If you wish to save the room anyway, first remove any unavailable multiviewer from the cluster.
- 

## Opening Rooms

### To open an existing room

- 1 Click the **Rooms** tab in the main window.
- 2 On the **File** menu, click **Open**.  
The **Open Room** window appears.



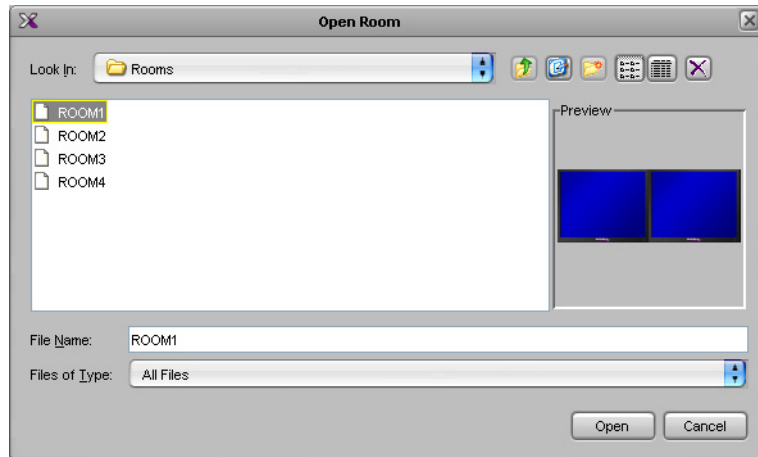

- 3 Select the room you wish to open, and then click **Open**.  
The selected room appears in the **Rooms** tab.

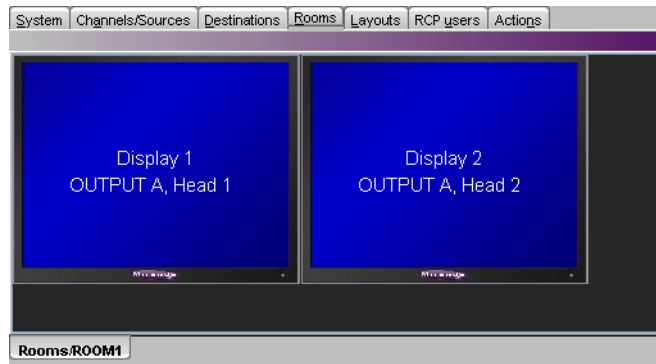

### Notes

- When you have more than one room open, you can switch from one to another by clicking the tabs at the bottom of the window.

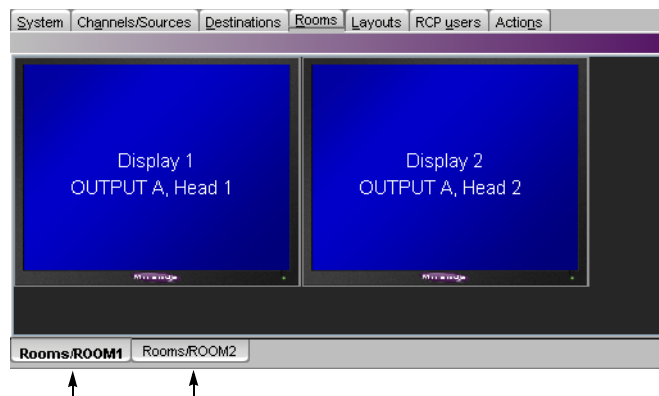

- In the case of a cluster system, it is possible to view a room configuration in offline mode, but any changes must be made in online mode.

## Closing Rooms

### To close a room

- On the **File** menu, click **Close**. Alternatively, click the Close button  on the toolbar.

## Deleting Rooms

Before deleting a room, make sure there are no layouts left for that room in your system configuration. If there are still layouts for this room, then XEdit will issue an error message and prevent you from deleting the room. See [Deleting Layouts](#) on page 228.

### To delete a room

- 1 Open the room you wish to delete (see [Opening Rooms](#), on page 196).
- 2 On the **File** menu, click **Delete**. Alternatively, click the Delete button  on the toolbar.

The system prompts you to confirm.

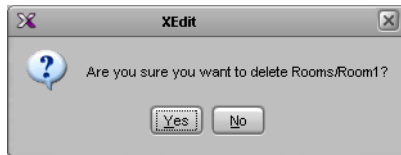

- 3 Click **Yes** to proceed.  
The room is removed from your system configuration.

## Adding Displays

### To add a display to a room

- 1 Select a display from the display library and drag it onto the room area.  
Alternatively, click the Display button  on the toolbar, and then click the room area to add a custom display.

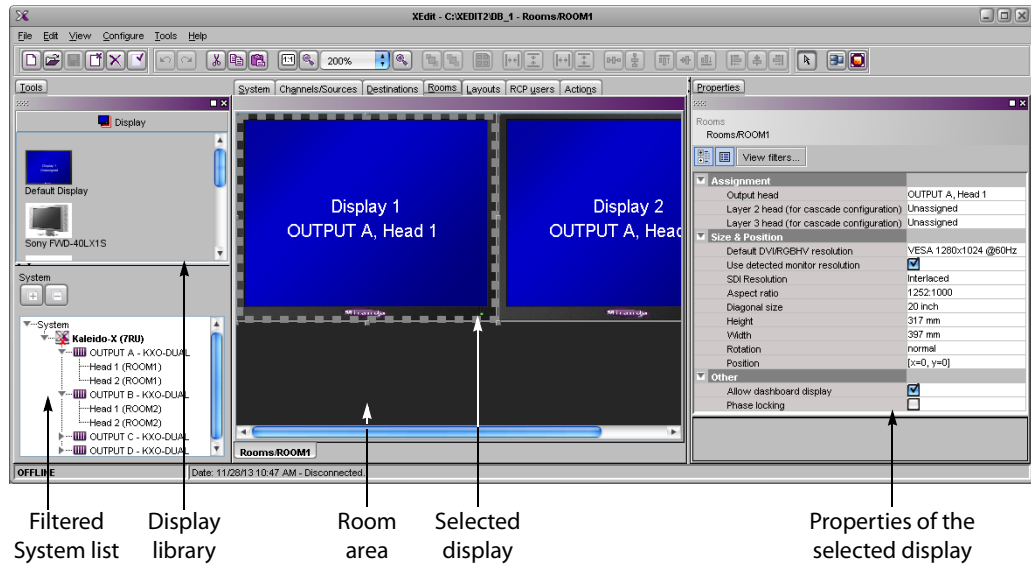

Note: All currently open display libraries appear on the **Tools** pane. Custom display libraries are stored separately from the XEdit workspace. See [Managing Display Libraries](#) on page 214 for details.

- Expand the filtered System list in the **Tools** pane, and then drag the appropriate output head onto a display in the **Rooms** tab.

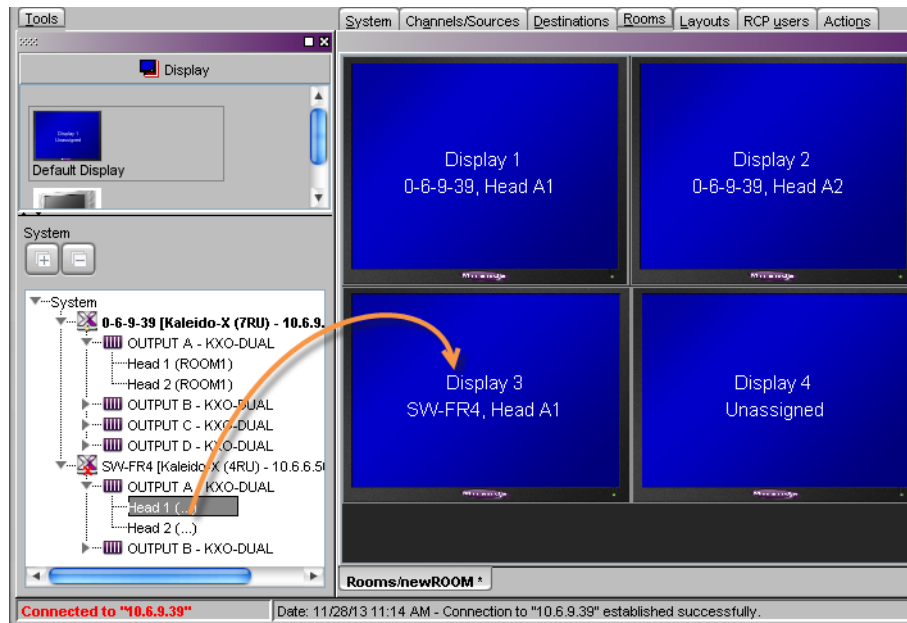

The name of the output head is indicated on the display. In the case of a Kaleido-X (4RU) or Kaleido-X (7RU), the card slot is also indicated. In the case of a cluster system, the name of the originating multiviewer also appears.

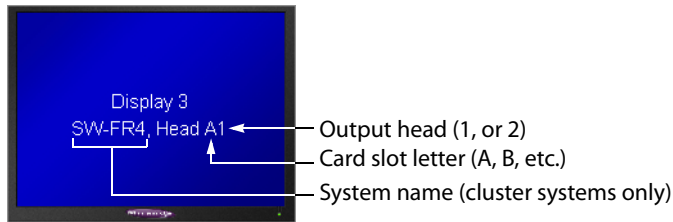

One output head cannot be assigned to more than one display at a time. When different displays are assigned the same output head, if the displays are part of the same room, then XEdit will issue an error message and prevent you from saving the room until the head assignment is corrected.

However, to facilitate room management — for example, in a cluster system where rooms and layouts have been created based on configurations from earlier standalone systems — XEdit will let you assign the same head to displays that are located *in different rooms*, but such *conflicting assignments will be marked in red* in the filtered System list displayed in the **Tools** pane, and should be resolved by removing a conflicting display (see [Removing Displays](#), on page 201), or by deleting the conflicting room (see [Deleting Rooms](#), on page 198).

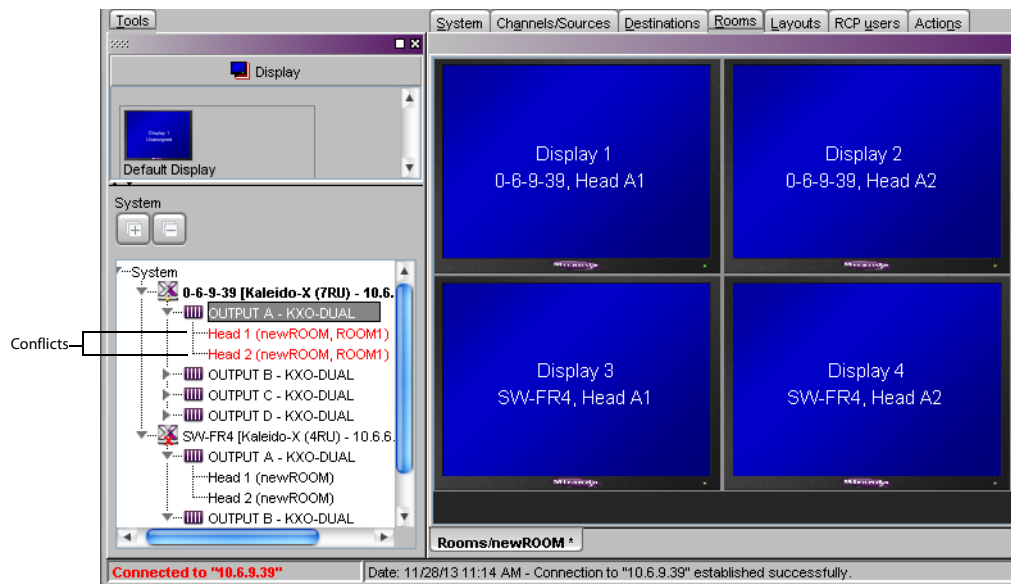

---

#### IMPORTANT

##### Conflicting head assignments

Neglecting to resolve conflicting head assignments could result in distorted layout elements on the monitor wall (which would happen, for example, if the same output head is assigned to two displays with different resolutions), or, in the case of a cluster, in the dashboard showing the wrong room name (from one of the earlier standalone configurations you may have used to create the cluster).

To prevent this from happening, open the old room configuration, and look for red *Head* elements in the filtered System list that appears at the bottom of the **Tools** pane. Clear the unwanted head assignments, either by removing the corresponding displays from the room layout (see [Removing Displays](#), on page 201), or by completely deleting the old room configuration if you do not need it anymore (see [Deleting Rooms](#), on page 198).

- 3 On the **File** menu, click **Save**.

The updated room configuration is saved.

## Removing Displays

Before removing a display, make sure there are no *room layouts* and no *full screen layouts* associated with this display in your system configuration. If there are still layouts for this display, then XEdit will issue an error message and prevent you from saving the room. See [Deleting Layouts](#) on page 228.

### To remove a display from a room

- 1 Open the room that contains the display you wish to remove (see [Opening Rooms](#), on page 196).
- 2 If there is a full screen zone associated with this display, click its border and then press Delete on your keyboard to remove it.
- 3 Click the display and then press Delete on your keyboard.
- 4 On the **File** menu, click **Save**.

The updated room configuration is saved.

## Adding Full Screen Zones

---

#### Notes

- Adding full screen zones to a room is optional.
- Do not span a full screen zone across more than one display; use spanned video monitors instead. See [Spanning](#) on page 221 for more information.

### To add a full screen zone to a room

- 1 Click the Full screen zone button  on the toolbar, and then click the room area to create the full screen zone.
- 2 Position and resize the zone as appropriate.

- 3 In the **Properties** pane, click the **Friendly name** box, and then type a name for the zone.

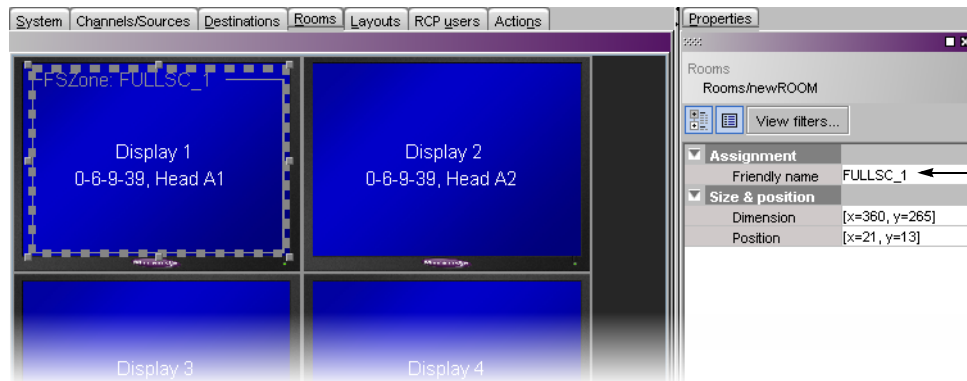

- 4 Press Enter on your keyboard to validate the new name, and then click **Save** on the **File** menu.  
The room configuration is saved.

## Removing Full Screen Zones

Before removing a full screen zone, make sure there are no *full screen layouts* associated with this zone in your system configuration. If there are still full screen layouts for this zone, then XEdit will issue an error message and prevent you from saving the room. See [Deleting Layouts](#) on page 228.

### To remove a full screen zone from a room

- 1 Open the room that contains the full screen zone you wish to remove (see [Opening Rooms](#), on page 196).
- 2 Locate the full screen zone, click its border and then press Delete on your keyboard.
- 3 On the **File** menu, click **Save**.

The updated room configuration is saved.

## Configuring Displays

The monitor wall driven by your Kaleido-X system may include displays of various shapes and sizes, each with its specific characteristics. The displays you add to your rooms in XEdit must be configured to match the attributes of their physical counterparts. The Kaleido-X software includes a set of predefined resolutions that cover most standard displays. Any custom resolutions you add to this set will be available throughout the system, and can be reused when configuring any display in any room.

You can manually configure display resolutions in two ways: either globally, from the **Tools** menu, or by clicking a specific display in a room.

In addition to monitor wall displays, your system can include other monitors connected to the multiviewer's HD-SDI outputs (one for each output head, available with the *SDI monitoring output* option). The HD-SDI output format on a given head depends on the resolution configured for the corresponding multiviewer output, and, in the case of a 1080-line resolution, on the selected scan format (interlaced, progressive) for this output head. In the case of a KMV-3911 or Kaleido-X16 multiviewer, you can enable phase-locking at the

output head level, to support production switchers (or other equipment) connected to the multiviewer's HD-SDI outputs.

## Viewing Room Display Properties

To view the properties for one of the display in a room

- 1 Click the display whose properties you wish to view.
- 2 Review the attributes and values that appear in the **Properties** pane.

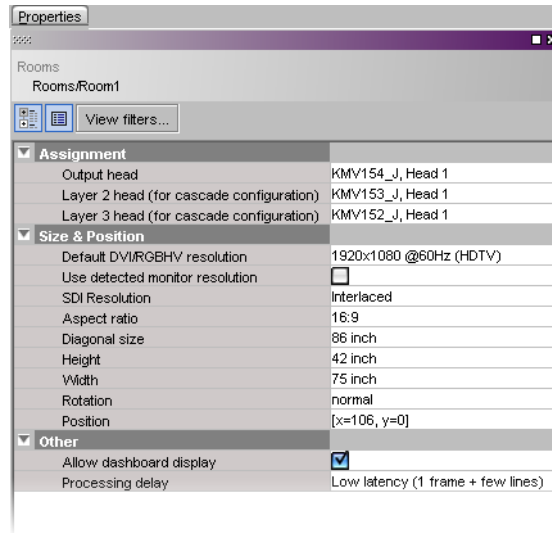

## Enabling EDID Auto-Detection in XEdit

The monitor EDID auto-detection feature is enabled by default in order to facilitate the initial setup of a Kaleido-X system. Setting an output head to a specific resolution, from a multiviewer service panel in iControl (if available), from the monitor wall (Kaleido-IP, Kaleido-X, Kaleido-X16), or from a Densité controller's local control panel (Kaleido-MX, Kaleido-Modular-X, KMV-3901/3911, Kaleido-XQUAD) disables the EDID auto-detection for this head.

To enable EDID auto-detection for a display

- 1 In the Rooms tab, click the display you wish to configure.
- 2 In the **Properties** pane, select the **Use detected monitor resolution** check box.

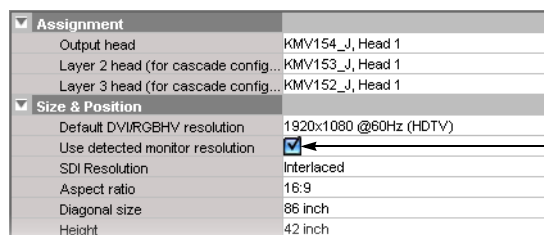

Select to enable  
automatic detection  
of EDID information

- 3 On the **File** menu, click **Save**.

## Configuring Custom Resolutions from the Tools Menu

To create a custom display resolution from the Tools menu

- 1 On the **Tools** menu, click **Edit resolutions**.

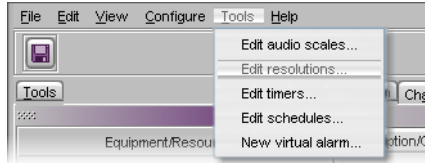

The **Edit Resolution Settings** window appears.

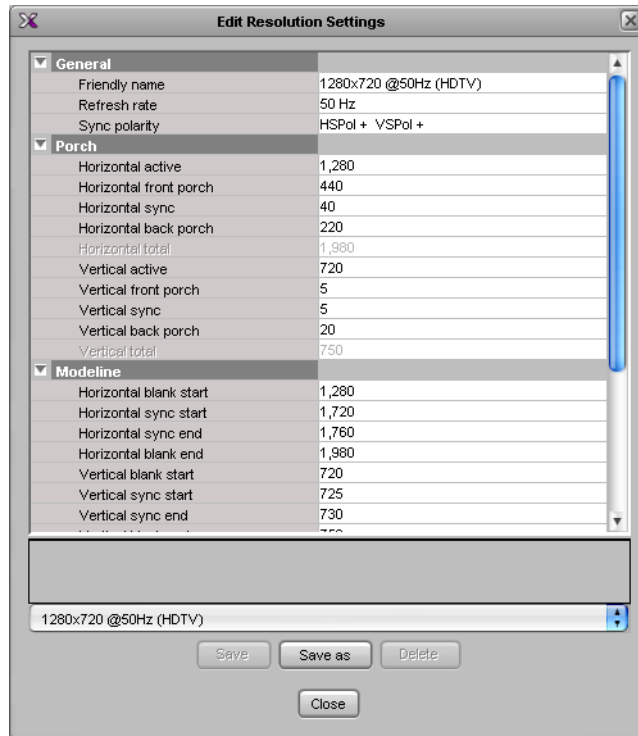

- 2 Select the resolution you wish to customize (or the one on which you wish to base a new resolution), from the list at the bottom of the window.

---

**Note:** When you modify one of the default resolutions, you can only save your changes as a new resolution. On the other hand, custom resolutions can be tweaked and saved repeatedly until the desired configuration is achieved. However, make sure that the active width and active height values you specify match those of one of the default resolutions, otherwise your custom resolution will be ignored.

---

- 3 Under either the **Porch** or the **Modeline** section—depending on whether you prefer to specify front porch, back porch, sync, and active values, or blank start, sync start, sync end and blank end—, set the refresh rate and other timing parameters so that they match those of the physical display you need to configure.



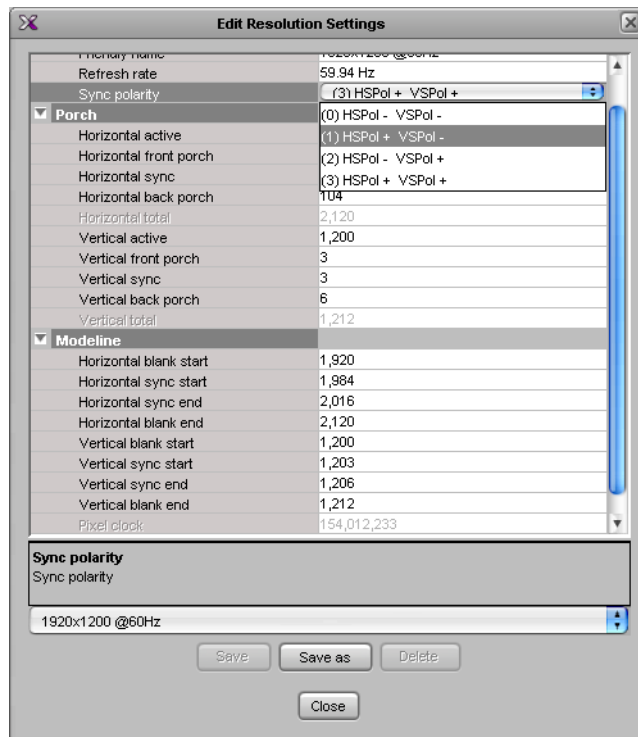

**Note:** In XAdmin's **Status and Options** page, these parameters are listed under the corresponding output card information, according to the blank/sync start/end modeline system, and with the sync polarity expressed as a number between 0 and 3. Refer to [Viewing a Multiviewer's Status Information](#), on page 515 for details.

**Example:** Suppose you want to configure the display that is connected to *head 1* of a Kaleido-X (7RU) multiviewer's OUTPUT D card. The image below shows the relevant data you need to copy to the **Modeline** section of the **Edit Resolution Settings** window.

OUTPUT D (master): KXO-DUAL (s/n 079201-20532001)	
Firmware 0xC0 / Safemode 0x5F	
KXO-DUAL - 3D support option	<input type="radio"/> Enable...
KXO-DUAL - Display (90 degree) rotation option	<input checked="" type="radio"/> Disable... (Key: C02E3BCD)
EDID DVI output 1 - EDID presence	<input checked="" type="radio"/>
EDID DVI output 1 - Frequency	59.95
EDID DVI output 1 - Horizontal active	1920
EDID DVI output 1 - Horizontal blank end	2080
EDID DVI output 1 - Horizontal blank start	1920
EDID DVI output 1 - Horizontal sync end	2000
EDID DVI output 1 - Horizontal sync start	1968
EDID DVI output 1 - Horizontal total	2080
EDID DVI output 1 - Sync polarity	1
EDID DVI output 1 - Vertical active	1200
EDID DVI output 1 - Vertical blank end	1235
EDID DVI output 1 - Vertical blank start	1200
EDID DVI output 1 - Vertical sync end	1209
EDID DVI output 1 - Vertical sync start	1203
EDID DVI output 1 - Vertical total	1235
EDID DVI output 2 - EDID presence	<input checked="" type="radio"/>
EDID DVI output 2 - Frequency	59.88
EDID DVI output 2 - Horizontal active	1680

Frequency and timing information

- 4 Type a name for the new resolution in the **Friendly name** box, and then click **Save as** to close the **Edit Resolution Settings** window. Alternatively, if you are modifying an existing custom resolution, you can click the **Save** button.

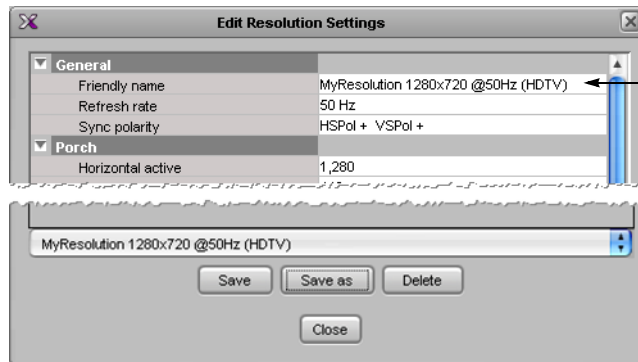

Type a name

## Configuring a Custom Resolution from a Specific Display in a Room

To configure a custom resolution from a specific display in a room

- 1 Click the display whose resolution you wish to configure.
- 2 Click the **Resolution** box in the **Properties** pane, and then click the button that appeared on the right of the resolution presets.  
The **Edit Resolution Settings** window appears.

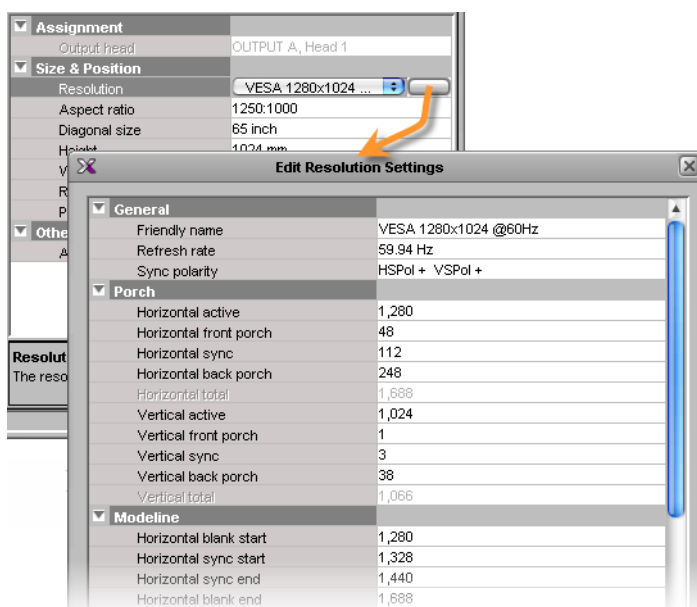

- Under either the **Porch** or the **Modeline** section—depending on whether you prefer to specify front porch, back porch, sync, and active values; or blank start, sync start, sync end and blank end—, set the refresh rate and other timing parameters so that they match those of the physical display you need to configure.

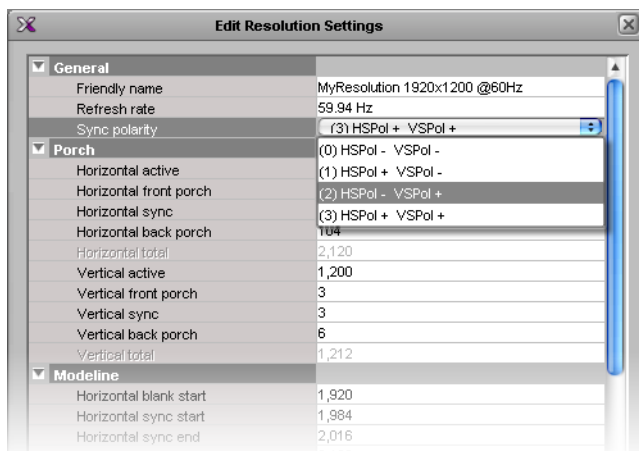

---

**Note:** In XAdmin's **Status and Options** page, these parameters are listed under the corresponding output card information, according to the blank/sync start/end modeline system, and with the sync polarity expressed as a number between 0 and 3. Refer to [Viewing a Multiviewer's Status Information](#), on page 515 for details.

---

**Example:** Suppose you want to configure the display that is connected to the OUTPUT C (master) KXO-DUAL card's head 1. The image below shows the relevant data you need to copy to the **Edit Resolution Settings** window.

OUTPUT D (master): KXO-DUAL (s/n 079201-20532001)	
Firmware 0xC0 / Safemode 0x5F	
KXO-DUAL - 3D support option	<input type="radio"/> Enable...
KXO-DUAL - Display (90 degree) rotation option	<input checked="" type="radio"/> Disable... (Key: C02E3BCD)
EDID DVI output 1 - EDID presence	<input checked="" type="radio"/>
EDID DVI output 1 - Frequency	59.95
EDID DVI output 1 - Horizontal active	1920
EDID DVI output 1 - Horizontal blank end	2080
EDID DVI output 1 - Horizontal blank start	1920
EDID DVI output 1 - Horizontal sync end	2000
EDID DVI output 1 - Horizontal sync start	1968
EDID DVI output 1 - Horizontal total	2080
EDID DVI output 1 - Sync polarity	1
EDID DVI output 1 - Vertical active	1200
EDID DVI output 1 - Vertical blank end	1235
EDID DVI output 1 - Vertical blank start	1200
EDID DVI output 1 - Vertical sync end	1209
EDID DVI output 1 - Vertical sync start	1203
EDID DVI output 1 - Vertical total	1235
EDID DVI output 2 - EDID presence	<input checked="" type="radio"/>
EDID DVI output 2 - Frequency	59.88
EDID DVI output 2 - Horizontal active	1680

*Frequency and timing information, as listed in XAdmin*

- 4 Type a name for the new resolution in the **Friendly name** box, and then click **Save as** to close the **Edit Resolution Settings** window. Alternatively, if you are modifying an existing custom resolution, you can click the **Save** button.

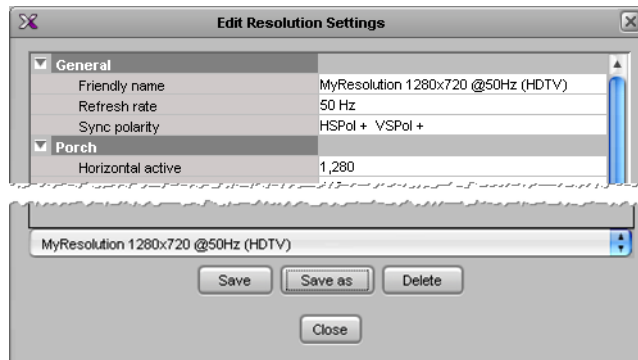

- 5 On the **File** menu, click **Save**.

## Changing Room Display Resolutions

To change the resolution for a display in a room

- 1 Click the display you wish to configure.
- 2 Click the **Resolution** box in the **Properties** pane.  
The resolution presets appears.

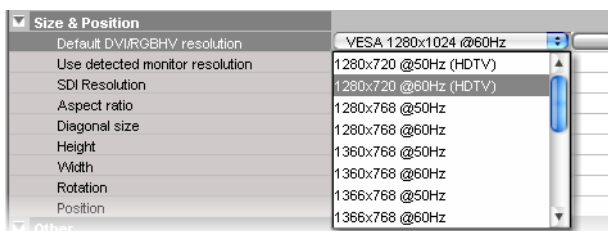

- 3 Select the appropriate resolution from the list.
- 4 On the **File** menu, click **Save**.

### Configuring the HD-SDI Monitoring Output Format

The HD-SDI output format on a given head depends on the resolution configured for the corresponding multiviewer output (see [Changing Room Display Resolutions](#), on page 208), and, in the case of a 1080-line resolution, on the selected scan format (interlaced, progressive) for this output head. In addition, EDID auto-detection must be *disabled* (see [Enabling EDID Auto-Detection in XEdit](#), on page 203). The following multiviewer output resolutions are supported: 1920 × 1080 (for an HD-SDI output in the 1080i or 1080p format) and 1280 × 720 (for an HD-SDI output in the 720p format). Any other DVI/RGBHV resolution will result in the HD-SDI output being disabled.

Multiviewer output resolution	HD-SDI output (interlaced)	HD-SDI output (progressive)
1280 × 720 50Hz	No output	720p 50Hz
1280 × 720 59.94Hz	No output	720p 59.94Hz
1920 × 1080 50Hz	1080i 50Hz	1080p 50Hz
1920 × 1080 59.94Hz	1080i 59.94Hz	1080p 59.94Hz
Any other HDMI resolutions	No output	No output

#### To configure the scan format for a 1080-line signal at the SDI monitoring output

- 1 In the Room area, click the display associated with the multiviewer output head whose properties you wish to configure.
- 2 In the **Properties** pane, verify that the selected default resolution configured for the monitor wall display is compatible with the desired format as the SDI output for this head (see table above), and make sure that the **Use detected monitor resolution** option is disabled.
- 3 Click the **SDI Resolution** box, and then select the appropriate scan format: **Progressive**, or **Interlaced**.

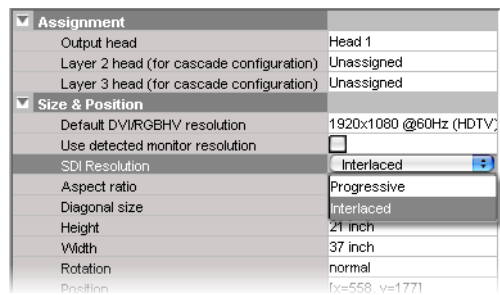

← monitor wall display resolution  
← EDID auto-detection *disabled*  
← scan format for a 1080-line signal at the SDI monitoring output

- 4 On the **File** menu, click **Save**.

### Enabling Phase Locking at the HD-SDI Monitoring Output

**KMV-3911** and **Kaleido-X16** multiviewers can feed production switchers (or other equipment) via their HD-SDI output. If your downstream equipment requires input signals that are in phase with the facility's genlock reference, then you need to enable phase locking at the corresponding output head. This increases the processing delay equally at the HD-SDI output and corresponding HDMI output.

---

**Note:** Phase locking is disabled by default, to allow for a minimal processing delay. Leave it disabled for all other multiviewer models, or if your system does not involve downstream equipment requiring phase-locked signals.

---

#### To enable phase locking at the HD-SDI output for a specific output head

- 1 Click the display associated with the head whose HD-SDI output you wish to configure, and then select the **Phase locking** check box in the **Properties** pane.



- 2 On the **File** menu, click **Save**.

### Disabling the Dashboard

A room can be configured to prevent the dashboard from appearing on specific displays. For instance, in a production control room, or if the Kaleido-X is used in the studio backdrop you may not want the dashboard to pop up, regardless of alarm conditions.

---

**Note:** Make sure the dashboard remains enabled on a least one display, in a room where alarm conditions can be monitored, since it is your only way to be notified in case of a card booting in offline mode, a duplicate IP address, a defective fan, a power supply alarm, etc.

---

#### To disable the dashboard for a specific display

- 1 Click the display on which you do not want the dashboard to appear, and then clear the **Allow dashboard display** check box in the **Properties** pane.

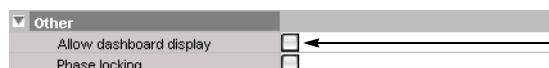

- 2 On the **File** menu, click **Save**.

## Changing a Display's Aspect Ratio

### Notes

- It is important to properly set the aspect ratio of a display, since this will affect the proportions of every component you will use to create layouts for this room. For instance, if the aspect ratio of a display does not match the aspect ratio of the actual display in the physical room, then a video window inside a layout will show distorted images.
- If you change the display aspect ratio later in the process, layouts created before the change will be broken.

### To change the aspect ratio of a display in a room

- 1 Click the display whose aspect ratio you wish to set.
- 2 Click the **Aspect ratio** box, in the **Properties** pane.

The aspect ratio presets appear.

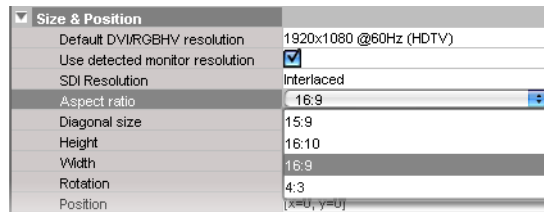

- 3 Select the appropriate aspect ratio from the list. Alternatively, type the desired ratio directly in the box.
- 4 On the **File** menu, click **Save**.

## Changing a Display's Diagonal Size

### To change the diagonal size of a display in a room

- 1 Click the display whose size you wish to configure.
- 2 Click the **Diagonal size** box in the **Properties** pane.

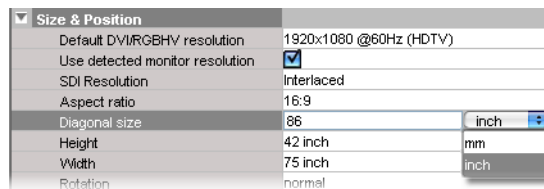

- 3 Select the appropriate unit of measurement from the list that appears inside the **Diagonal size** box, and type the size.
- 4 On the **File** menu, click **Save**.

## Changing a Display's Height

### To change the height of a display in a room

- 1 Click the display whose height you wish to configure.
- 2 Click the **Height** box in the **Properties** pane.

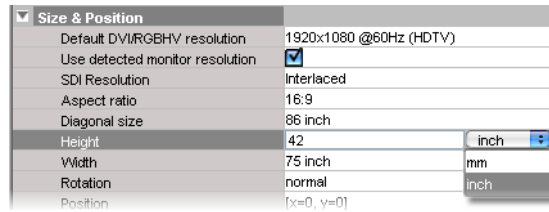

- 3 Select the appropriate unit of measurement from the list that appears inside the **Height** box and type the height.
- 4 On the **File** menu, click **Save**.

## Changing a Display's Width

To change the width of a display in a room

- 1 Click the display whose width you wish to configure.
- 2 Click the **Width** box in the **Properties** pane.

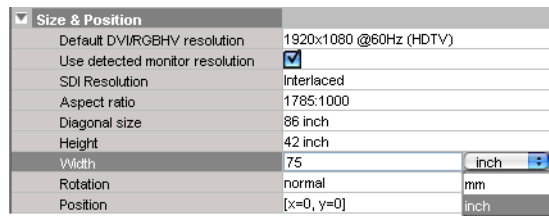

- 3 Select the appropriate unit of measurement from the list that appears inside the **Width** box and type the width.
- 4 On the **File** menu, click **Save**.

## Changing a Display's Rotation

---

### Notes

- The KMV-3901/3911, and Kaleido-XQUAD multiviewers do not support display rotation.
  - For rotation to work properly on the monitor wall, the *Display Rotation* option must be enabled on the corresponding output card (in the case of a Kaleido-X, Kaleido-MX, or Kaleido-Modular-X multiviewer) or HDMI output port (in the case of a Kaleido-X16). The option can be enabled and verified in XAdmin's Status and Options page (see [Hardware and Software Options](#), on page 443).
  - The Kaleido-IP supports display rotation. If two displays are connected to the multiviewer, then they must both have the same orientation. It is not yet possible to enable or verify the rotation option in XAdmin's Status and Options page, for this multiviewer model. Contact Technical Support for activation and configuration instructions (see [Contact Us](#), on page 529).
  - In the case of a Kaleido-MX or Kaleido-Modular-X system, every time the orientation of a display has changed in XEdit, the multiviewer automatically restarts after the room is saved (or, if you were working in offline mode, once you have exported the database).
-



### To change the rotation setting for a display in a room

- 1 Click the display you wish to configure.
- 2 Click the **Rotation** box in the **Properties** pane.

The rotation presets appear.

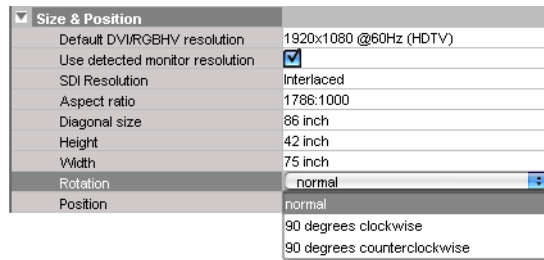

- 3 Select the configuration that matches the way the actual display is mounted in the physical room: normal, rotated 90 degrees clockwise, rotated 90 degrees counterclockwise.
- 4 On the **File** menu, click **Save**.

If you already had created layouts for the room associated with the display whose rotation setting you just changed, you may need to adjust layout elements in these layouts (see [Creating Layouts](#), on page 217).

### Changing a Display's Position

#### To change position of a display in a room

- 1 Click the display whose position you wish to configure.
- 2 Click the **Position** box in the **Properties** pane, then click the button that appears inside the box.

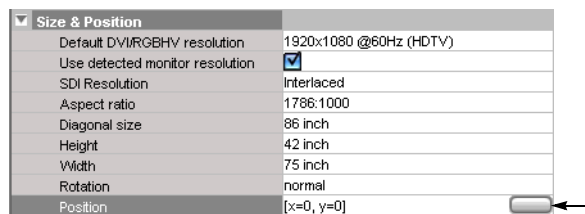

The **Specify Position** window appears.

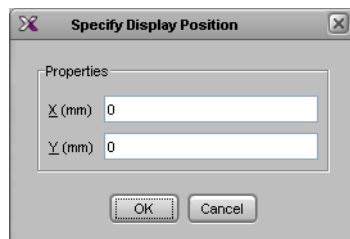

- 3 Type the appropriate values in the **X (mm)**, and **Y (mm)** boxes, and then click **OK**. The values appear in the **Position** box.
- 4 On the **File** menu, click **Save**.

## Managing Display Libraries

The default display library includes configurations for the most popular display models. You can also create your own display configurations, and add them to custom display libraries. All open display libraries appear on the **Tools** pane. The default display library is always open. Custom display libraries are stored separately from the XEdit workspace, and must be opened explicitly.

### Creating Custom Display Libraries

#### To create a custom display library

- 1 Click the **Rooms** tab in the main window.
- 2 On the **File** menu, click **New**. Alternatively, click **Open** to open an existing room.
- 3 On the **File** menu, click **New display library**.

Alternatively, right-click anywhere inside the **Tools** pane's display library area, and then click **New display library** on the menu.

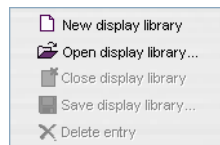

The new display library appears below the default display library area in the **Tools** pane.

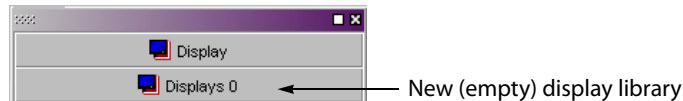

- 4 Right-click anywhere in the display library area, and then click **Save Display Library** on the menu.

The **Save Display Library** window appears.

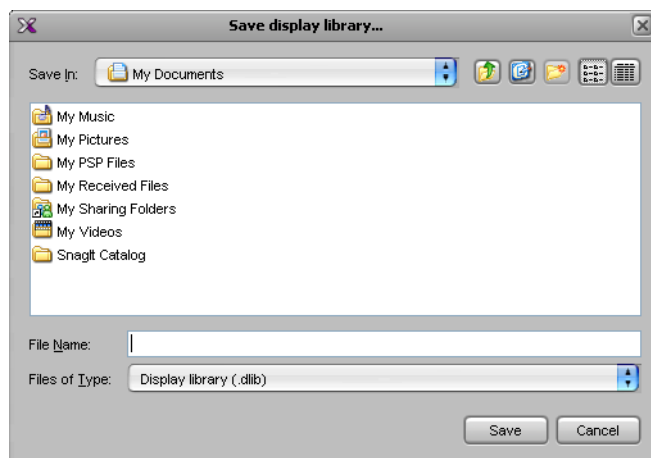

- 5 Type a name for the new custom display library, and then click **Save**. Custom display libraries are stored separately from the XEdit workspace. They have a `.dlib` extension.

## Adding Displays to Custom Libraries

### To add a display to a custom display library

- 1 Click the Display button  on the toolbar, and then click the room background to add a display. Alternatively drag a display from a display library onto the room, or choose a display within an existing room.
- 2 Customize the display as needed, and then drag it onto the display library *while holding the Ctrl key*.

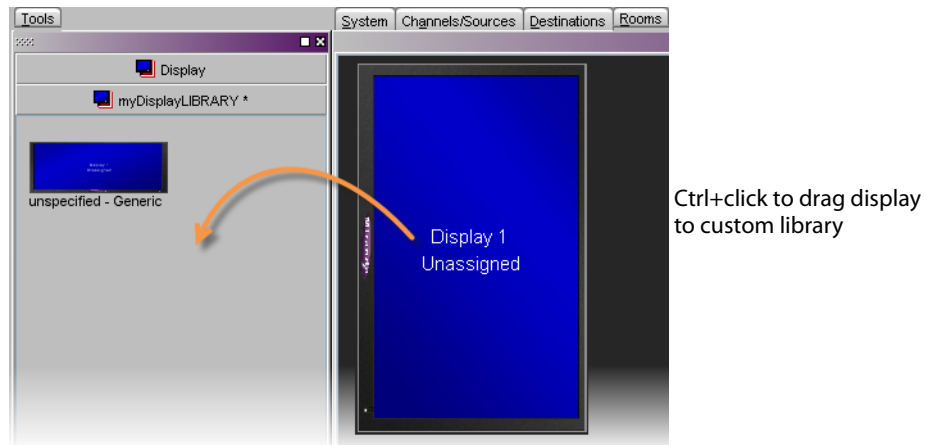

**Note:** It is not possible to further customize a display once it is inside a library. Should you need to do so, drag the display to the room area, apply the required changes, and then Ctrl+drag the modified display to the display library. You can then remove the obsolete display from the library.

## Removing Displays from Custom Libraries

### To remove a display from a custom library

- Click the display you wish to remove and then press Delete.
- Alternatively, right-click its icon and then click **Delete entry** on the menu.

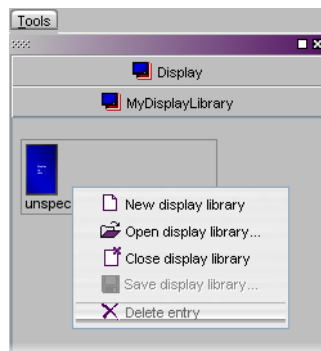

## Closing Display Libraries

### To close a display library

- Once the custom library is saved, you can right-click in the library area, and then click **Close display library** on the menu.

- Alternatively, click **Close display library**, on the **File** menu.

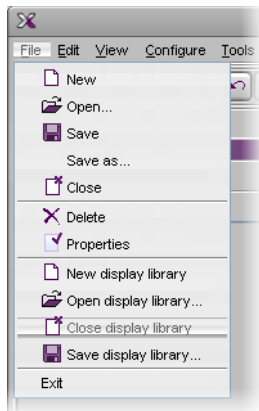

## Opening Display Libraries

### To open a custom display library

- In the **Tools** pane, right-click anywhere in the display library area, and then click **Open display library** on the menu.
- Alternatively, click **Open display library**, on the **File** menu.

---

**Note:** It is possible to have multiple custom libraries open at the same time.

---

# 9 Creating Layouts

This section describes layout elements and their purposes, and provides detailed configuration instructions.

## Key Concepts

### Layouts and Layout Elements

#### Layout elements

Term	Description
Layout	<p>A <i>layout</i> is a visual grouping of monitors that appear on displays within a room. A layout includes different types of monitors in a variety of placements and sizes. There are two types of layouts: room layouts and full screen layouts. See <a href="#">Managing Layouts</a> on page 223.</p> <p>Note: Before creating layouts, you may want to review your room configurations. Should a display be rotated in a room (see <a href="#">Changing a Display's Rotation</a>, on page 212), some layout elements in your existing room layouts may require adjustments.</p>
Monitor	<p>A <i>monitor</i> (also called <i>widget</i>) is an element that is part of a layout. The Kaleido-X software supports several types of primitive layout elements (e.g., clocks, video monitors, audio monitors, UMDs, time code monitors, etc.), as well as composite monitors. All primitive layout elements, except for the video monitors and subtitling monitors are <i>graphical</i> layout elements. See <a href="#">Adding Monitors to a Layout</a> on page 229.</p>
Video monitor	<p>A <i>video monitor</i> is a layout element used to define an area for displaying a video signal. It is represented in XEdit by the boundary box made visible by clicking the element.</p> <p>Within a video monitor, the <i>video window</i> is the active area where the video signal is displayed, possibly including closed captions or teletext. The <i>video window</i> is represented in XEdit by the blue rectangle inside a video monitor. The video window does not necessarily cover the complete video monitor's area. See <a href="#">Configuring Video Monitors</a> on page 236.</p>
Composite monitor	<p>A <i>composite monitor</i> is a group of primary elements that can be seen as a single object within a layout. Composite monitors typically include a video window, one or more audio level meters, and a UMD with two tallies.</p>

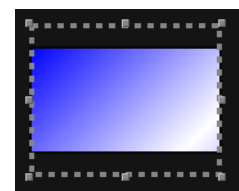

**Layout elements (continued)**

Term	Description
Time code monitor	A <i>time code monitor</i> displays the Ancillary Time Code (ATC) from an HD video signal, or the time code found in an embedded SDI video signal, part of the vertical interval of an analog signal (VITC), or other external Linear Time Code (LTC). This monitor also supports time code information from external providers (see <a href="#">Configuring logical sources based on external alarm providers</a> , on page 187). Time code monitors can be used for monitoring the duration of programs. See <a href="#">Configuring Time Code Monitors</a> on page 259.
Timer	A <i>timer</i> can be slaved to a production timer, controlled from the Kaleido-RCP2 (with start, stop and reset control via GPI inputs), and/or used for monitoring the duration of programs. Three <i>timer modes</i> are available: (1) UP: timer counts up starting from zero up to a preset time, (2) DOWN: timer counts down from a preset time to zero, and (3) REMAINING: timer counts down from the current time until it reaches a preset time. A <i>timer monitor</i> is based on a timer defined within the Kaleido-X system. Timers are defined and configured in XEdit. Timer monitors can be configured directly on the monitor wall. See <a href="#">Configuring Timers</a> on page 261.
Audio monitor	An <i>audio monitor</i> (also called <i>audio level meter</i> or <i>ALM</i> ) is a graphical layout element that provides a visual representation of sound. See <a href="#">Configuring Audio Monitors</a> on page 252, and <a href="#">Configuring Audio Scales</a> , on page 256.
Loudness monitor	A <i>loudness monitor</i> is a graphical layout element that provides a visual representation of the perceived loudness of an audio program. It provides two measures (short term, and momentary loudness) per audio program. See <a href="#">Configuring Loudness Monitors</a> on page 254.
UMD	An <i>under monitor display (UMD)</i> has a <i>text label</i> that can be static or dynamically updated by a peripheral device. It can also have <i>left and right tally indicators</i> . The UMD typically indicates the name of the video source seen in a video monitor. See <a href="#">Configuring UMDs</a> on page 267.
Alarm monitor	<i>Alarm monitors</i> help you see the status of global and virtual alarms, but their use is not limited to this type of alarms. When any alarm level is assigned to an alarm monitor, the status of this alarm is shown. When using the global alarm at the text label level, the alarm monitor displays the text value of the alarm, which is a readable name. See <a href="#">Configuring Alarm Monitors</a> on page 274 and <a href="#">Alarm latch</a> , on page 31 for more information.
Subtitling monitor	A <i>subtitling monitor</i> defines an area for displaying subtitles extracted from a video signal. By using a subtitling monitor you can monitor subtitling from a specific DVB or SCTE 27 stream, independently from the associated video stream. Requires the <i>CC/XDS</i> option (see <a href="#">Hardware and Software Options</a> , on page 443). See <a href="#">Configuring Subtitling Monitors</a> on page 277. Note: With the current version of the Kaleido-X software, the subtitling monitor supports DVB and SCTE 27 subtitles, from Kaleido-IP sources only.
Metadata monitor	A <i>metadata monitor</i> defines an area for displaying XDS, or digital content advisory descriptor (CAD) information extracted from a video signal. Requires the <i>CC/XDS</i> option (see <a href="#">Hardware and Software Options</a> , on page 443). See <a href="#">Configuring Metadata Monitors</a> on page 282.

**Layout elements (continued)**

Term	Description
V-chip monitor	The <i>V-chip monitor</i> provides a visual indication of the V-chip rating from the CC (608) metadata in an SD video signal, or from the CC (608) legacy caption data, when such data is present within an HD video signal. Requires the CC/XDS option. See <a href="#">Hardware and Software Options</a> on page 443, and <a href="#">Configuring V-Chip Monitors</a> , on page 283.
Clock	A <i>clock</i> is the visual representation of time in a video or display. It can be based on a reference LTC signal or on the multiviewer system time. Clocks can be in a digital or analog format. See <a href="#">Configuring Clocks</a> on page 285. Note: The KMV-3901/3911 supports digital clocks only.
Widget library	A <i>widget library</i> is a collection of predefined layout elements. Monitors from a library can be used to help construct a layout. Default widget libraries are available from XEdit's <b>Tools</b> pane. You can also create your own libraries. See <a href="#">Managing Widget Libraries</a> on page 298. Note: As of version 7.40 of the Kaleido-X software, two new 16:9, and 4:3 composite widget libraries with <i>proportional elements</i> are available. In these libraries, the primary monitors within each composite have all their dimensions defined as a percentage, which allows intuitive resizing, whereas, in the legacy <i>maximum video area</i> libraries, some primary monitors have fixed height or width, to allow more space for the video window. The new composite monitors with proportional elements suit most purposes. It is preferable to always use them, unless you specifically require monitors with fixed dimensions.

**Aspect Ratio**

Aspect ratio information can be encoded within a video signal following different standards: AFD 2016, AFD VI, or WSS. The Kaleido-X software may use this information to render the video raster in the target video window on the monitor wall.

Term	Description
AFD VI	Active format description encoded in the video index.
AFD 2016	Active format description encoded in the ancillary data (according to the SMPTE 2016 standard).
WSS	Wide Screen Signaling.
Video raster	Video signal that is displayed inside the video monitor on a monitor wall.

The aspect ratio of video displayed on the monitor wall can be automatically adjusted. With multiple video players (monitors) on a monitor wall, in multiple formats/aspect ratios, this makes it easy to switch from one format to another in the same player. Automatic adjustment can be accomplished in two ways:

- **Video monitor slaved to input:** A video monitor can be slaved to the input format such that the video monitor will change its aspect ratio according to the input signal type (e.g. SD, HD, DVI).

- **Video raster follows AFD/WSS:** A video monitor can be configured so that WSS, AFD VI, or AFD 2016 metadata is used to crop (and/or add black bars to) the video signal, giving the video raster the correct aspect ratio.

---

**Note:** The Kaleido-X software does not yet support automatic aspect ratio adjustment based on decoded AFD/WSS information for signals originating from Kaleido-IP multiviewers.

---

This metadata can be reported as text inside a UMD. Its presence can also be made available in alarms as well as via SNMP traps.

See [Configuring Automatic Aspect Ratios](#) on page 244, for more information.

---

**Note:** Aspect ratio decoding can also be configured for each multiviewer input, based on decoded AFD or WSS metadata when such information is available within the input signal (see [Calibrating Aspect Ratio Decoding](#), on page 141).

---

## Cropping Mode

The display of a video signal can be cropped to remove unwanted portions, or to zoom in on a specific portion of the image. In XEdit, you can configure a video monitor to display signals in underscan or overscan mode (see [Video Cropping/Zooming](#), on page 242). Not supported on Kaleido-IP.

**Underscan:** When a video window is in underscan mode, it displays the full signal without cropping any of the image.

**Overscan:** When a video window is in overscan mode, it displays a selected area of the image, typically zoomed and cropped to fit the window. By default, the overscan mode crops the left, right, top and bottom margins by 5% each.

### Changing the underscan/overscan mode dynamically

It is possible to dynamically change the overscan/underscan mode based on the current feed assigned to a video monitor. For example, you can change logical sources in a video monitor using Gateway commands, where a video source requires the monitor to be in overscan mode but a graphics source requires the monitor to be in underscan mode to avoid cropping the image. A custom action script can make the monitor change its scan mode depending on the format detected. For information on how to create such a script, contact [support@miranda.com](mailto:support@miranda.com).

### Custom overscan

The amount of overscan applied can be customized to some extent, which will depend on the original signal resolution, relative to the size of the video window where the image is displayed. Excessive cropping may result in a loss of video image on the monitor wall. Likewise, when a layout has several monitors with heavy cropping settings on the same display head, some video windows may turn blank.

The examples listed below may be used as guidelines. Unless specified otherwise, these are based on a *1080p display resolution*. Displays with a lower resolution can afford more cropping.



- In the case of a *full screen* video window:
  - The KMV-3901/3911 supports cropping up to **6%** in both directions (i.e., 6% vertically, and 6% horizontally).
  - The Kaleido-X and Kaleido-X16 support cropping up to **18%** in both directions.
  - Kaleido-MX, and Kaleido-Modular-X support cropping up to **40%** in both directions, for *SD 525 sources* in a 1920×1200 monitor.
- In the case of a video window occupying  $1/16^{th}$  of the display area:
  - The KMV-3901/3911 supports cropping up to **17%** in both directions for a *1080i HD source*, or up to **38%** for an SD source.
  - The Kaleido-X and Kaleido-X16 support cropping up to **42%** in both directions.

## Spanning

Graphical layout elements (UMDs, audio monitors, etc.) and video monitors can be made to span across multiple heads, on up to 4 displays, portrait or landscape, in any combination. On displays that fit perfectly side by side, this gives the impression of having one large screen. When any layout element is spanned across displays, an icon automatically appears in the top right corner.

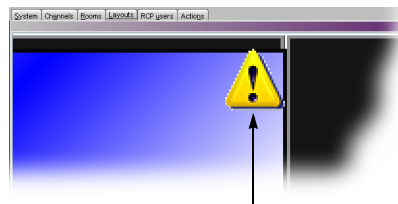

Warning icon appears even if monitor is one pixel over the edge

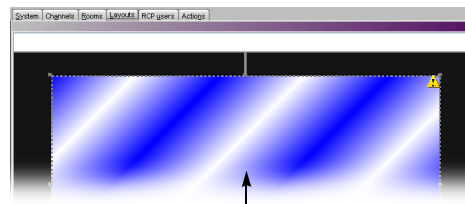

Video monitor spanned over two displays with warning icon in top right corner

To avoid pixel cropping on spanned monitors, you must position room displays so that there is no gap between them. Use XEdit's **Remove horizontal space** and/or **Remove vertical space** buttons to make sure your displays are perfectly positioned for spanning.

You must also ensure that each display has the same pixel-per-inch (or -per-mm) ratio, calculated as horizontal resolution (pixels) divided by display width (inches or mm) and vertical resolution divided by display height. Ideally, you should use displays that have the same physical size and resolution.

The figure below shows two displays properly sized and positioned for monitor spanning.

Display 1		Display 2	
<b>Assignment</b>		<b>Assignment</b>	
Output head	OUTPUT A, Head 1	Output head	OUTPUT A, Head 2
Layer 2 head (for cascade configuration)	Unassigned	Layer 2 head (for cascade configuration)	Unassigned
Layer 3 head (for cascade configuration)	Unassigned	Layer 3 head (for cascade configuration)	Unassigned
<b>Size &amp; Position</b>		<b>Size &amp; Position</b>	
Default DVI/RGBHV resolution	VESA 1600x1200 @60Hz	Default DVI/RGBHV resolution	1366x768 @60Hz
Use detected monitor resolution	<input checked="" type="checkbox"/>	Use detected monitor resolution	<input checked="" type="checkbox"/>
SDI Resolution	Interlaced	SDI Resolution	Interlaced
Aspect ratio	4:3	Aspect ratio	16:9
Diagonal size	1000 mm	Diagonal size	784 mm
Height	600 mm	Height	384 mm
Width	800 mm	Width	683 mm
Rotation	normal	Rotation	normal
Position	[x=0, y=0]	Position	[x=802, y=0]

Horizontal: 1600 pixels ÷ 800 mm = 2 pixels/mm  
Vertical: 1200 pixels ÷ 600 mm = 2 pixels/mm

Horizontal: 1366 pixels ÷ 683 mm = 2 pixels/mm  
Vertical: 768 pixels ÷ 384 mm = 2 pixels/mm

### Notes

- The Kaleido-IP does not yet support spanned monitors.
- In the case of KMV-3901/3911 and Kaleido-XQUAD multiviewers, which support a maximum of eight video monitors over two displays, a spanned video monitor counts as two (i.e. if you have one spanned video monitor, you can only add six other video monitors to your layout; if you span two video monitors, you can add only four other video monitors).
- Monitors can extend outside the edge of a display, but not completely.
- The use of a mouse is not completely supported with spanned video monitors.
- Do not span a layout element beyond a maximum of 3000 × 1800 pixels. When spanning or scaling video monitors in a layout, avoid heavy cropping settings (generally avoid exceeding 15% in any direction).

---

Notes (continued)

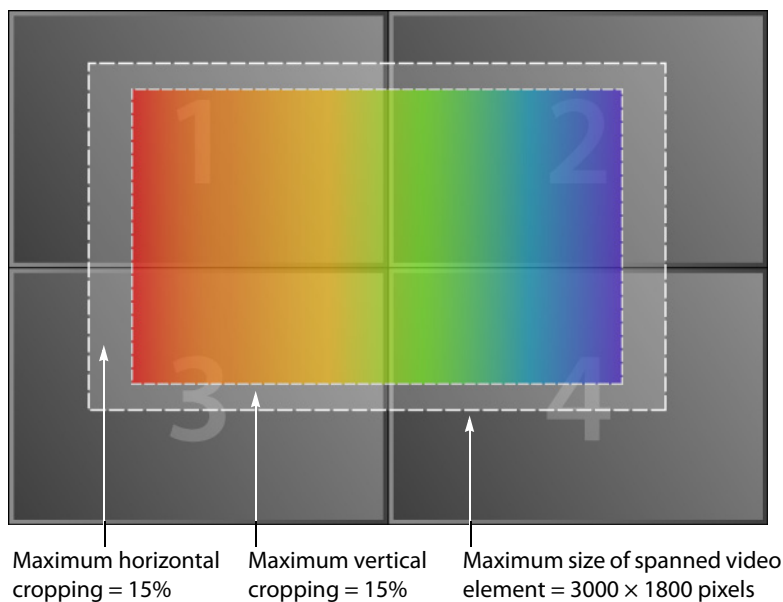

- There is no special configuration to be done in XEdit.

---

## Detailed Directions

### Managing Layouts

---

Note: Before creating or modifying a layout for a **Kaleido-IP** system, review the guidelines listed in the [Network Considerations](#) section on [page 452](#).

---

#### Opening Layouts

To open an existing layout

- 1 Click the **Layouts** tab.
- 2 On the **File** menu, click **Open**. Alternatively, click the Open button  on the toolbar. The **Open Layout** window appears.

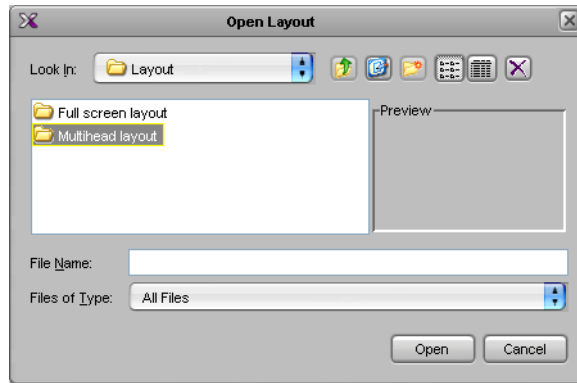

- Double-click **Full screen layout**, if you wish to open a full screen layout.
- Double-click **Multihead layout**, if you wish to open a room layout.

3 Double-click the appropriate room.

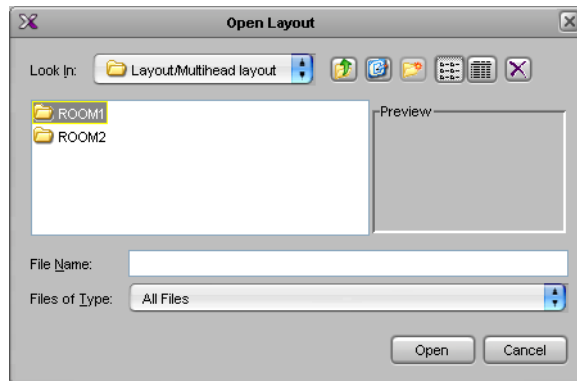

4 Click the layout you wish to open, and then click **Open**.

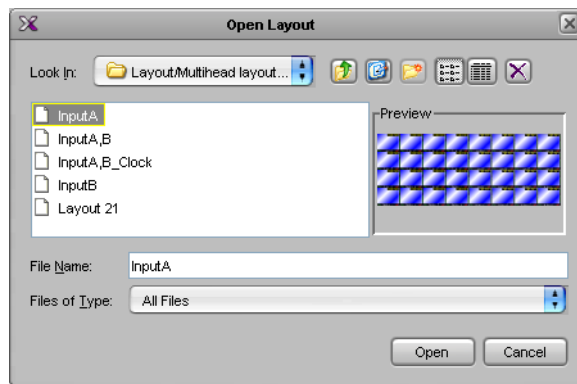

The selected layout appears in the **Layouts** tab.

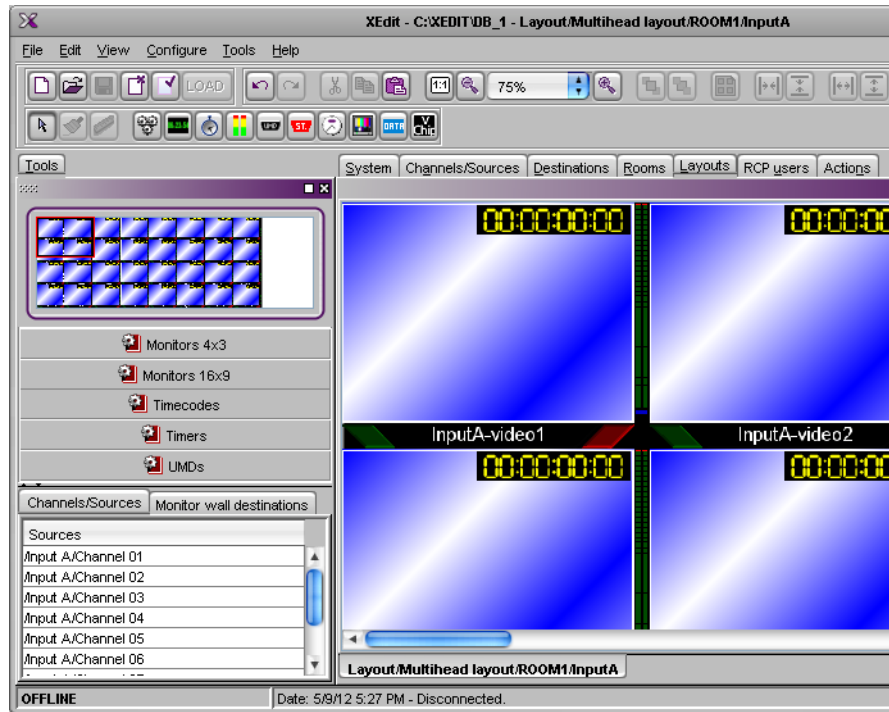

**TIP**

When you have more than one layout open, you can switch from one to another by clicking the tabs at the bottom of the window.

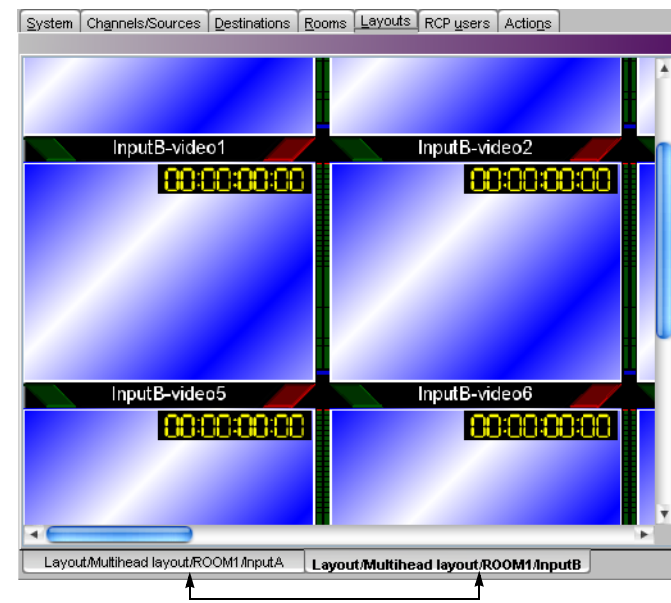

**Loading a Layout on the Monitor Wall**

To load the current layout on the monitor wall, directly from XEdit, in online mode

- Click the **LOAD** button on the toolbar.

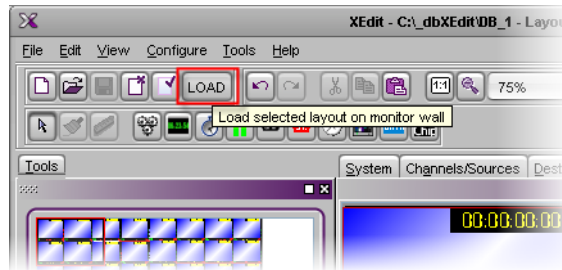

The current layout appears on the monitor wall.

## Closing Layouts

### To close the current layout

- On the **File** menu, click **Close**. Alternatively, click the Close button  on the toolbar.

## Creating Room Layouts

### To create a room layout

- 1 Click the **Layouts** tab in the main window.
- 2 On the **File** menu, click **New**.  
The **Create a New Layout** window appears. It lists all the existing rooms and full screen zones in your system.
- 3 Click the name of the room where this layout will be displayed.

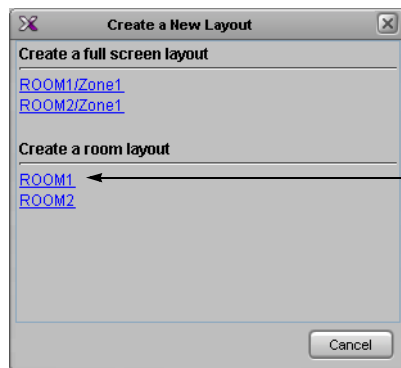

An empty layout appears.

- 4 Add at least one monitor to the layout (see [Adding Monitors to a Layout](#), on page 229).
- 5 Assign every monitor a logical source (see [Assigning Logical Sources or Monitor Wall Destinations to Monitors](#), on page 232).
- 6 On the **File** menu, click **Save**.  
The **Save Layout** window appears.

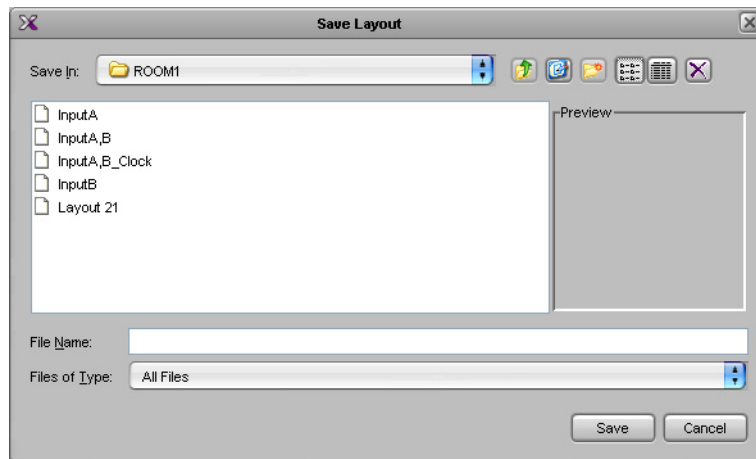

- 7 Type a name for the layout, and then click **Save**.

## Creating Full Screen Layouts

### To create a full screen layout

- 1 Click the **Layouts** tab in the main window.
- 2 On the **File** menu, click **New**.

The **Create a New Layout** window appears. It lists all the existing rooms and full screen zones in your system.

- 3 Click the name of the full screen zone in which this layout will be displayed.

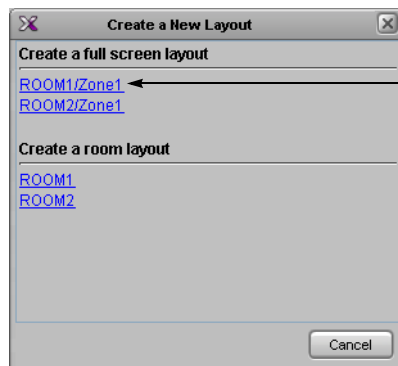

An empty layout area appears.

- 4 Add at least one monitor to the layout (see [Adding Monitors to a Layout](#), on page 229).  
If the full screen layout includes more than one composite monitor, you can designate one of them who will receive its source assignments from the monitor under the mouse pointer on the monitor wall, by selecting the **Full screen layout monitor** option in the **Properties** pane.

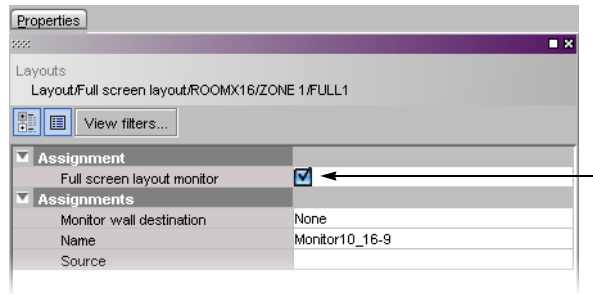

Make the appropriate assignments for the other elements in the layout (see [Assigning Logical Sources](#) or [Monitor Wall Destinations to Monitors](#), on page 232).

- 5 On the **File** menu, click **Save**.

The **Save Layout** window appears.

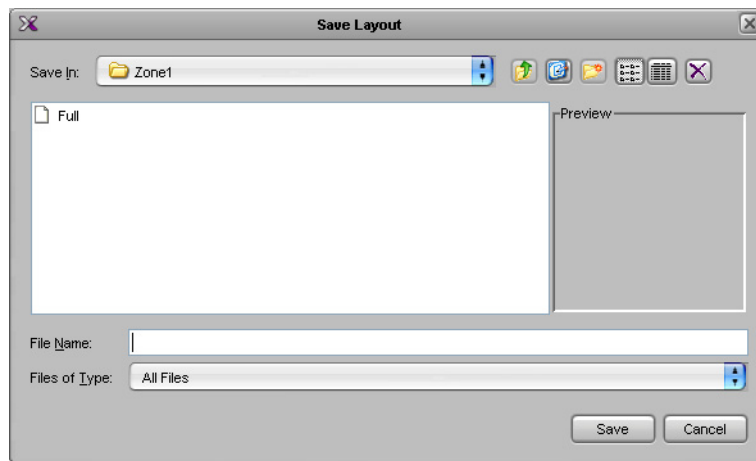

- 6 Type a name for the full screen layout, and then click **Save**.

## Deleting Layouts

### To delete a layout

- 1 Open the layout you wish to delete (see [Opening Layouts](#), on page 223).
- 2 On the **File** menu, click **Delete**.

The system prompts you to confirm.

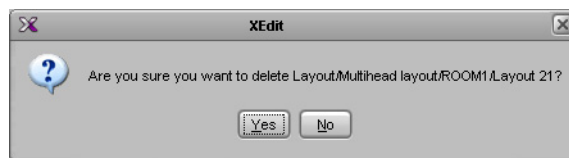

- 3 Click **Yes** to proceed.

The layout is removed from your system configuration.



---

## Adding Monitors to a Layout

---

### Notes

- When adding monitors to a layout, avoid overlapping graphical layout elements with one another. For example, making sure that there be no overlap between UMDs and audio monitors in a layout will ensure optimal performance.
  - Before creating or modifying a layout for a **Kaleido-IP** system, review the guidelines listed in the [Network Considerations](#) section on [page 452](#).
  - In the case of a **KMV-3901/3911** or **Kaleido-XQUAD** multiviewer, layouts are subject to the following limitations:
    - up to eight video monitors over two displays (overlapping is not supported),
    - up to four stereo audio level meters per video monitor,
    - one time code per video monitor,
    - only digital clocks are supported,
    - XDS metadata monitors are not supported.
  - In the case of the **Kaleido-X**, **Kaleido-X16**, and **Kaleido-IP** multiviewers, every *output head* supports up to 64 video monitors, across both the current layout and a full screen layout when used.
  - In the case of a **Kaleido-X** or **Kaleido-X16**, the minimum *width* supported for a video window is 1/16th of the original signal's *horizontal* resolution.
  - In the case of a **Kaleido-X**, the minimum *height* supported for a video window is 91 pixels.
  - In the case of a **Kaleido-MX** or **Kaleido-Modular-X** multiviewer, every *output head* supports up to 64 video monitors. However, if every monitor is associated with audio meters and a time code monitor, then the maximum is 24 video windows per output head. If a layout is used to monitor color teletext, then it should be limited to 16 windows per output head. The image can be scaled down to 1/8 of the original signal's resolution. The minimum width supported for a video window is 128 pixels.
- 

### To add monitors to a layout

- 1 Drag components from the widget libraries onto the layout, or create custom components, using the toolbar buttons ().

---

Note: All open widget libraries appear in the **Tools** pane. See [Widget library](#) on [page 219](#).

---

- 2 Resize, move and configure the monitors until the desired layout is achieved. For detailed configuration instructions on the different monitor types, see:
  - [Configuring Video Monitors](#), on [page 236](#)
  - [Configuring Audio Monitors](#), on [page 252](#)
  - [Configuring Loudness Monitors](#), on [page 254](#)
  - [Configuring Time Code Monitors](#), on [page 259](#)

- [Configuring Timers](#), on page 261
- [Configuring UMDs](#), on page 267
- [Configuring Alarm Monitors](#), on page 274
- [Configuring Subtitling Monitors](#), on page 277
- [Configuring Metadata Monitors](#), on page 282
- [Configuring V-Chip Monitors](#), on page 283
- [Configuring Clocks](#), on page 285
- [Working with Composite Monitors](#), on page 289
- [Managing Widget Libraries](#), on page 298

## Removing Monitors

### To remove a monitor from a layout

- Click the monitor you wish to remove, and then press Delete on your keyboard.

---

#### TIP

To remove multiple monitors in a single operation, extend your selection by using the standard Ctrl+click keyboard shortcut.

---

## Duplicating Monitors

### To duplicate a monitor within a layout

- 1 Click the monitor you wish to duplicate.
- 2 On the **Edit** menu, click **Duplicate**. Alternatively, press Ctrl+D.  
A copy of the monitor is added to the layout.
- 3 Move the new monitor to the appropriate position on the layout.
- 4 Press Ctrl+D again, and repeat until the desired number of copies of the monitor are added to the layout.

The new copies are automatically positioned at intervals matching the relative positions of the original monitor and its first duplicate.

## Automatically Populating a Grid-Type Layout

Use the *Auto-layout* tool, to quickly create a layout containing several rows of up to 256 identical composites.

### To automatically populate a grid-type layout

- 1 Add a first monitor to the layout (see [Adding Monitors to a Layout](#), on page 229, and [Working with Composite Monitors](#), on page 289).
- 2 Position the monitor so that its upper left corner marks the location where you wish to start populating the grid.
- 3 Click the monitor, and then click the Auto-layout button () on the toolbar.
- 4 In the **Auto-Layout** window, type the total number of monitors you wish to spread over the area delimited by the upper left corner of the current monitor and the bottom right corner of the current head, and then click **OK**.

The first monitor is resized and replicated until the grid area is populated with the specified number of monitors.

**Note:** To undo this action, you will need to press Ctrl+Z twice: once to remove the copies, and then once more to restore the first monitor's initial size.

## Copying layouts

### To copy a layout

- 1 Open the layout you wish to duplicate.
- 2 On the **File** menu, click **Copy layout to**, point to the appropriate room, and then either select an existing layout from the list, or click **Empty layout**.

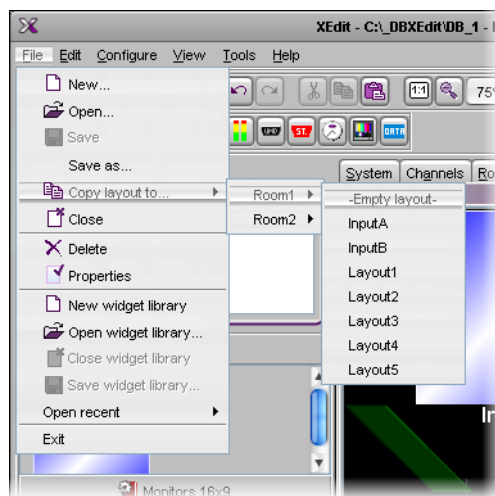

A two-pane window appears. The left pane represents the source layout, and the right pane represents the destination room where the new layout is to be used.

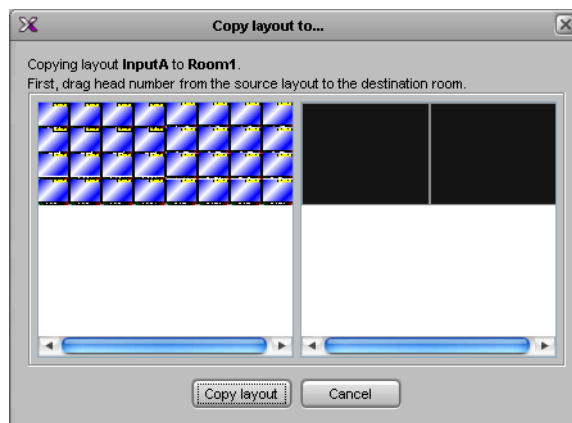

- 3 Drag one head from the source pane to the destination pane.
  - 4 Repeat until every part of the source layout you wish to copy has been dragged to the appropriate head in the destination pane, and then click **Copy layout**.
- The **Save Layout** window appears.

- 5 In **Save Layout**, type a name for the new layout, and then click **Save**. Alternatively, you can replace an existing layout with the new layout.

### Assigning Logical Sources or Monitor Wall Destinations to Monitors

In addition to the widget libraries, the **Tools** pane includes lists from which you can make assignments by dragging logical sources and monitor wall destinations onto monitors (you do not need to select the monitor first).

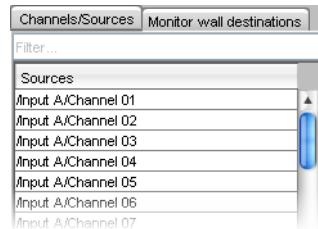

#### To assign a logical source to a monitor

- Select a logical source from the **Channels/Sources** list, in the **Tools** pane, and then drag it onto the appropriate monitor.

#### To assign a monitor wall destination to a monitor

- Select a destination from the **Monitor wall destinations** list, in the **Tools** pane, and then drag it onto the appropriate monitor.

Type in the filter box located above the **Channels/Sources**, and **Monitor wall destinations** lists, to hide sources or destinations that do not match the filter text or regular expression.

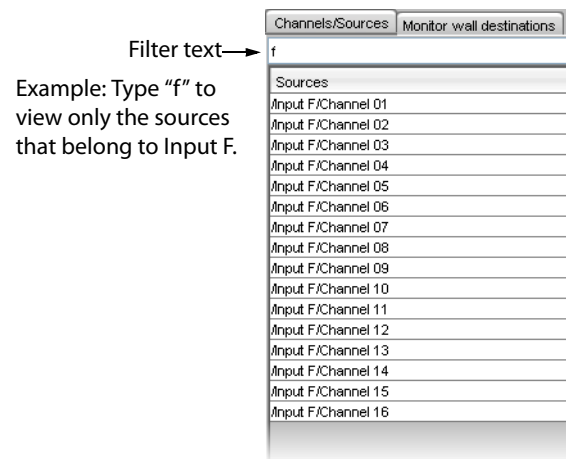

When assigning logical sources or monitor wall destinations to monitors in a layout, it may happen that the selection migrates to an adjacent element from the **Channels/Sources** or **Monitor wall destinations** list during the drag-and-drop operation. Once you selected a logical source or monitor wall destination from the corresponding list, dragging the selected element horizontally until the pointer exits the **Tools** pane, or performing a slower drag-and-drop may help.

#### To assign different monitor wall destinations to *individual* components within a composite monitor

- 1 Double-click the composite monitor to unlock it.

- 2 Click a component you wish to configure as a monitor wall destination, within the unlocked composite.
- 3 In the **Properties** pane, click the **Monitor wall destination** box, and then select the appropriate destination from the list.
- 4 Repeat from [step 2](#) until you have made the required assignments for this composite.
- 5 Click outside the composite monitor to lock it.

When you load a layout to the monitor wall, monitors that are not configured with a logical source assignment may be blank (until you manually set the assignment) but, if a monitor was configured as a monitor wall destination, then it will remember its last source assignment (if any). Keep in mind that, if two monitors are assigned the *same* monitor wall destination, they will both reflect source assignments made to any of them during operation. You may want to keep track of already assigned monitor wall destinations, if this is something you wish to avoid, and carefully review any layouts you create or modify based on elements from other layouts.

### Selecting a Background Image for a Layout

For some purposes, you may wish to display a layout's elements against a specific static image.

#### To select a background image for a layout

- 1 Click the **Layouts** tab, and open the layout whose background you wish to set.
- 2 Click the display background on the layout.
- 3 In the **Properties** pane, click the **Background image** box, under **Appearance**, and then click the button that appeared at the end of the box.

The **Select Image** window appears.



- 4 If the image you wish to use is not already listed in **Select Image**, then click the Open button  to open the **Browse Image** window. Locate the image, select it, and then click **Open**.

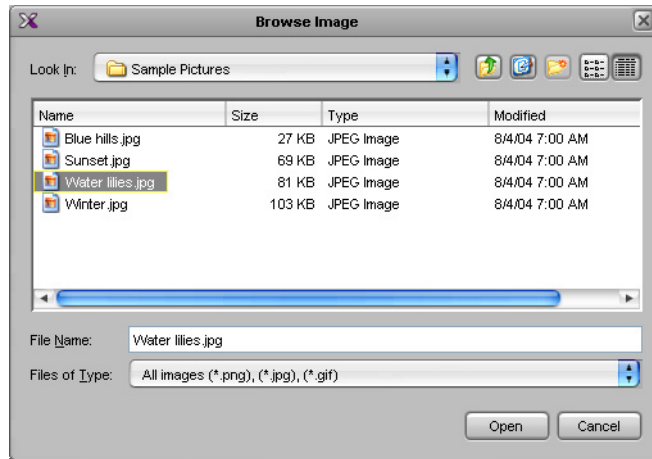

The image is imported into the database.

---

**Note:** The maximum size for each image is 256 KB, and the maximum overall size (for all images) is 10 MB. The image can be in PNG, GIF, or JPEG format. Images can be used on multiple layouts and only need to be imported to the database once.

---

- 5 In **Select image**, select the image from the **Image selection** list, and then click **OK**.

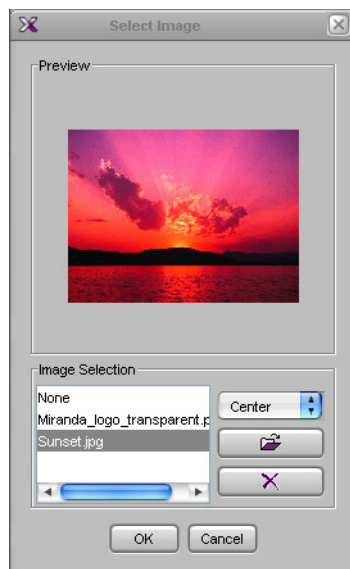

The image appears in the layout background.

### Setting up a Layout for Background Keying from the DVI Input

This section explains how to set up a layout's background to be keyed out and replaced with content from the DVI input (see [DVI keying mode](#), on page 120).

---

#### Notes

- The Kaleido-IP, Kaleido-MX, Kaleido-Modular-X, KMV-3901/3911, and Kaleido-XQUAD multiviewers do not support DVI keying.

Notes (continued)

- Since the DVI input cannot be resized, the resolution on the PC that feeds this input is best set to match the selected display's (head) resolution. The DVI background is always positioned from the top-left corner of the display and is drawn pixel for pixel. If the resolutions do not match, some part of the DVI input might be missing or noise might be displayed.

To use the DVI input as the background in a layout

- 1 Click the background of the layout.
- 2 In the **Properties** pane, click the **Background color** box, and then click the button that appears inside the box to open the color picker window.

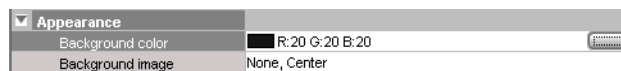

- 3 In **Colors**, click the **RGB** tab, and then set the **Red** to 254, **Green** to 0 and **Blue** to 254.

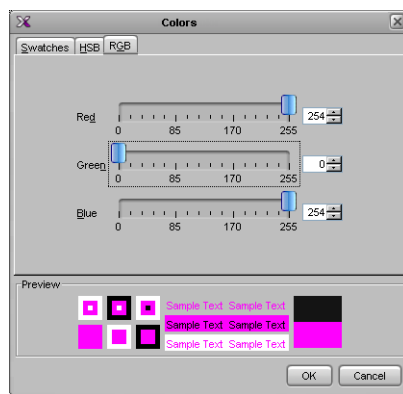

**Note:** Since bright pink colors matching the RGB values listed below are considered pass-through colors, and since background keying is always enabled, if a layout's background color (or any monitor's color attribute) is set to any of these RGB values, the DVI input will be displayed in the corresponding areas on the monitor wall. If there is no signal at the associated DVI input (or the multiviewer does not support DVI input, as would be the case with a Kaleido-IP, Kaleido-MX, Kaleido-Modular-X, KMV-3901/3911 or Kaleido-XQUAD), residual data may be visible in such areas.

- **Pass-through colors:** RGB (254,0,254), (254,0,255), (254,1,254), (254,1,255), (255,0,254), (255,0,255), (255,1,254), (255,1,255)

Do not use these colors for any monitor's color attributes. A layout's background should only be set to such a color if a DVI input will be contributing the actual background for this layout on the monitor wall.

- 4 Click **OK**.
- 5 If the area you wish to configure for background keying covers more than one head, repeat the procedure for the remaining heads, by clicking the corresponding areas in the layout.
- 6 On the **File** menu, click **Save**.

## Zooming and Panning a View

To adjust the portion of a layout or room that is shown in the main window

- Press and hold the Ctrl key, then press the plus key (+) to zoom in or the minus key (–) to zoom out.
- Press and hold the Ctrl key, then rotate the mouse wheel to zoom in or out.
- Type the zoom factor you wish to apply (in the range of 2% to 1600%) directly in the zoom box.
- Press and hold the spacebar, then click and drag to pan.
- Use the scroll bars at the right side and bottom of the **Layouts** or **Rooms** tab.
- In the case of a layout view, click and drag the layout navigator's red rectangle in the **Tools** pane.

## Showing and Hiding the Layout Navigator

To show or hide the layout navigator

- On the **View** menu, click **Navigator**. Alternatively, press Ctrl+Shift+N.

The layout navigator will appear in the **Tools** pane if it was hidden, and vice versa.

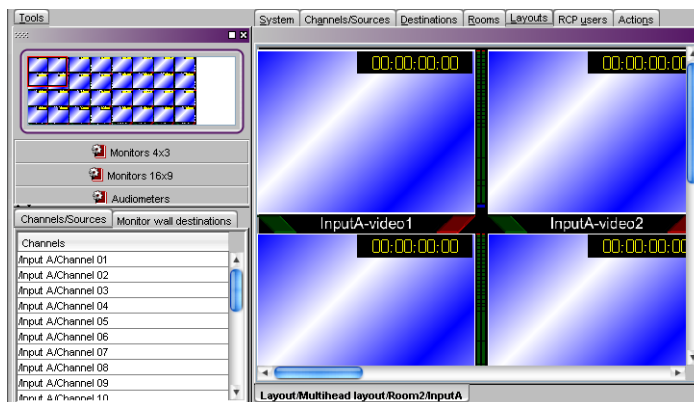

## Configuring Video Monitors

In XEdit, you can configure several properties for a video monitor in a layout.

To configure a video monitor

- 1 In XEdit, click the **Layouts** tab, and then open the desired layout.
- 2 Unlock the appropriate composite monitor if applicable (see [Unlocking a Composite Monitor](#), on page 295).
- 3 Click the video monitor you wish to configure.
- 4 To pre-assign a logical source to be monitored by default, to configure a video monitor as a monitor wall destination, or to configure reporting behaviors, see:
  - [Assigning Logical Sources or Monitor Wall Destinations to Monitors](#), on page 232.
  - [Setting Monitored Levels for a Video Monitor](#), on page 237.
  - [Setting a Video Monitor's Text Mode](#), on page 248.
  - [Configuring a Video Monitor's Alarm Reporting Behavior](#), on page 245.



- [Configuring a Video Monitor's Source Reporting Behavior](#), on page 246.
- 5 To configure dimensions, and resizing behavior, see:
    - [Resizing a Video Monitor](#), on page 238.
    - [Setting a Video Monitor's Aspect Ratio](#), on page 238.
    - [Adding Safe Area Markers](#), on page 239.
    - [Adding a Custom Safe Area Image](#), on page 239.
    - [Video Cropping/Zooming](#), on page 242.
    - [Configuring Automatic Aspect Ratios](#), on page 244.
  - 6 Click outside the composite monitor to lock it, if applicable.
  - 7 On the **File** menu, click **Save**.

### Setting Monitored Levels for a Video Monitor

When a system's logical sources include more than one level under a given category, the first level is selected by default for monitoring. In the case of a video monitor, you may change the default assignments for video, audio, and alarm levels.

#### To change the default levels selected for a video monitor

- 1 If your system's logical sources include more than one video level (e.g., to monitor 3D stereoscopic signals), select the ones you wish to monitor from the **Video level (left/mono)**, and **Video level (right)** lists.

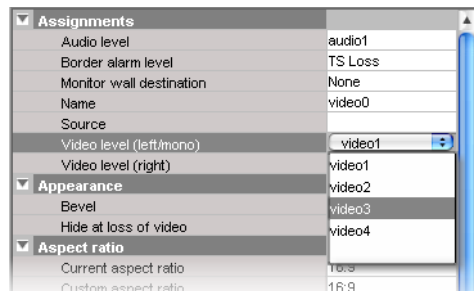

- 2 To monitor a different alarm level, or the source's global alarm, select the appropriate level from the **Border alarm level** list.

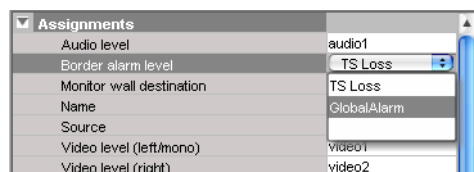

- 3 If you wish the default *Monitor audio* action associated with this video monitor to use a different audio level, select the desired level from the **Audio level** list.

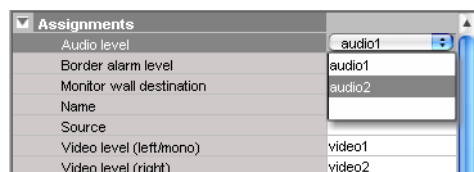

## Resizing a Video Monitor

### To resize a video monitor

- Drag any of the corner handles, inwards or outwards.  
The video monitor, and the associated video window, will become smaller or larger, and they will both keep their aspect ratio.
- Drag any of the side handles, inwards or outwards.  
The bounds of the video monitor will change, while the video window will still keep its aspect ratio.
- Change the aspect ratio property of the video monitor. See [Setting a Video Monitor's Aspect Ratio](#) below.  
The video monitor will keep its bounds, and the video window will be resized to fill as much of the video monitor area as possible, given the new aspect ratio.

---

**Note:** In the case of a Kaleido-X or Kaleido-X16, the minimum *width* supported for a video window is 1/16<sup>th</sup> of the original signal's *horizontal* resolution. In the case of a Kaleido-X, the minimum *height* supported for a video window is 91 pixels. For a Kaleido-MX or Kaleido-Modular-X, the minimum width is 128 pixels. In the case of a KMV-3901/3911, Kaleido-XQUAD, or Kaleido-IP, there is no minimum size.

---

## Setting a Video Monitor's Aspect Ratio

### To set a video monitor's aspect ratio

- 1 Click the video monitor whose aspect ratio you wish to configure.

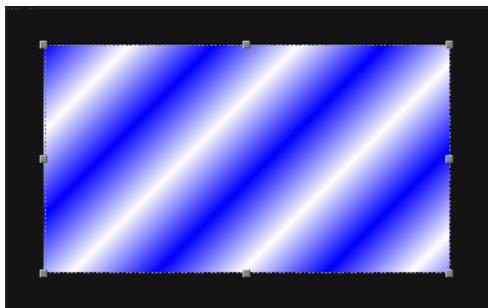

*Video monitor with an aspect ratio of 16:9*

---

**Note:** Double-click the video monitor, if it is part of a composite monitor.

---

- 2 In the **Properties** pane, click the **Current aspect ratio** box, and then select the appropriate aspect ratio from the list.

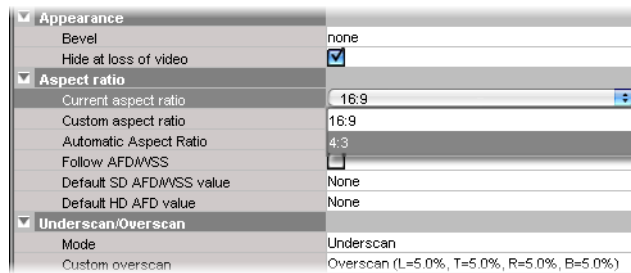

The selected aspect ratio is applied to the video window, within the video monitor.

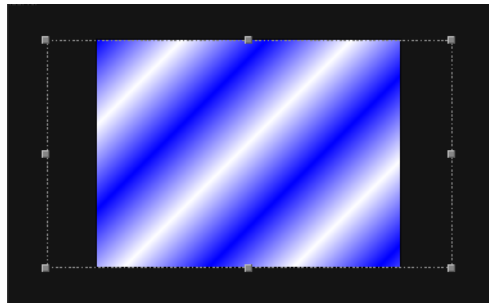

*Video window's aspect ratio changed to 4:3, within a 16:9 video monitor*

### To set a custom aspect ratio for a video monitor

- 1 In the **Properties** pane, click the **Custom aspect ratio** box.

The box becomes editable.

- 2 Type the appropriate aspect ratio, and then press Enter.

The new aspect ratio is applied to the video window, within the video monitor, and it is added to both the **Current aspect ratio**, and **Custom aspect ratio** lists.

---

**Note:** The custom values are appended to the **Custom aspect ratio** list on an ongoing basis. They can then be applied to other monitors in other layouts. **Current aspect ratio** only lists the current custom ratio, if any, in addition to the default 16:9, and 4:3 values.

---

### Adding Safe Area Markers

#### To add safe area markers for a video monitor in a layout

- In the **Properties** pane, select the appropriate options, under **Safe area markers**.

### Adding a Custom Safe Area Image

XEdit allows you to superimpose an image, e.g. a brand graphics, on top of a video monitor in such a way that a video signal will show through the transparent areas in the graphics. This is accomplished by adding a free-form safe area image to the video monitor. The image can be in PNG, GIF, or JPEG format.

---

#### Notes

- The maximum **size** for each image is 256 KB, and the maximum overall size (for all images) is 10 MB. Images can be used on multiple layouts and only need to be imported to the database once.

Notes (continued)

- To ensure that the **aspect ratio** of the imported image is preserved, you should position the graphics on a fully transparent background with the same aspect ratio as the video monitor on which it is to appear.
- In the case of a **cascade** system, XEdit must be connected to the multiviewer that will provide the source for the corresponding video monitor. A monitor that is not associated with a specific source is displayed by the system closest to the display.

To add a free-form safe area image to a video monitor

- 1 In the **Properties** pane, select the **Show markers** check box, under **Safe area markers**.

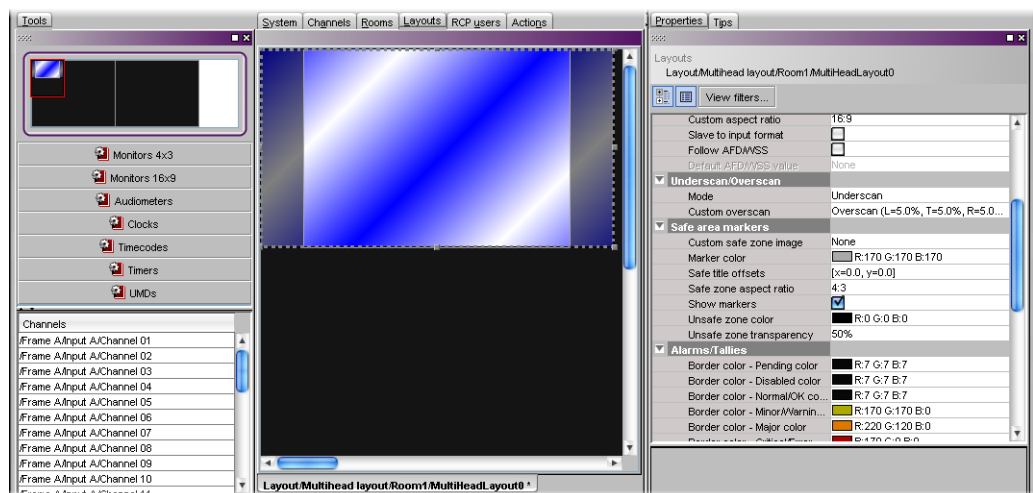

- 2 Click the **Custom safe zone image** box.

A button appears inside the box.

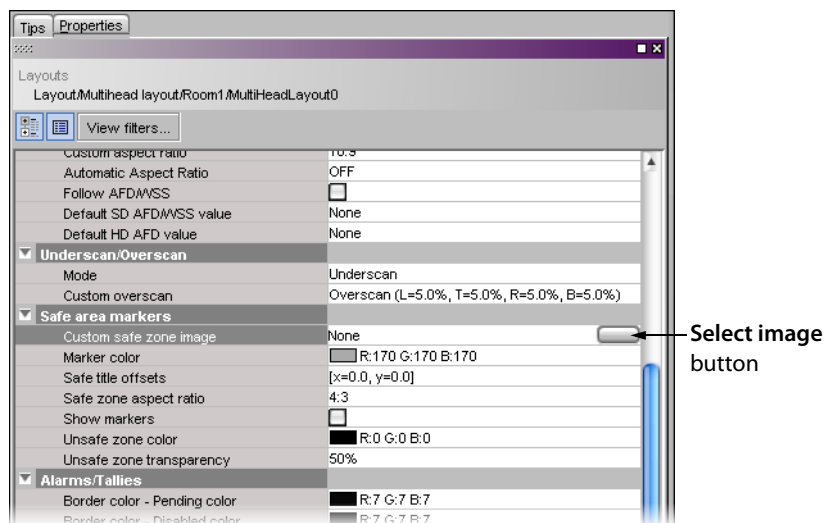

- 3 Click the button to open the **Select Image** window.



- 4 If the image you wish to use is not already listed in **Select Image**, then click the Open button  to open the **Browse Image** window. Locate the image, select it, and then click **Open**.

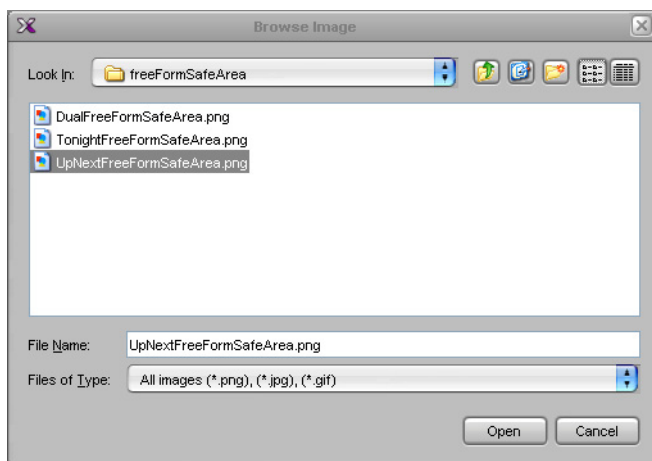

The image is imported into the database.

- 5 In **Select image**, select the image from the **Image selection** list, and then click **OK**.

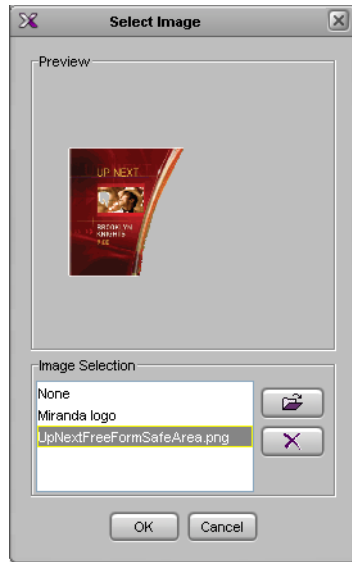

6 The image appears on the video monitor.

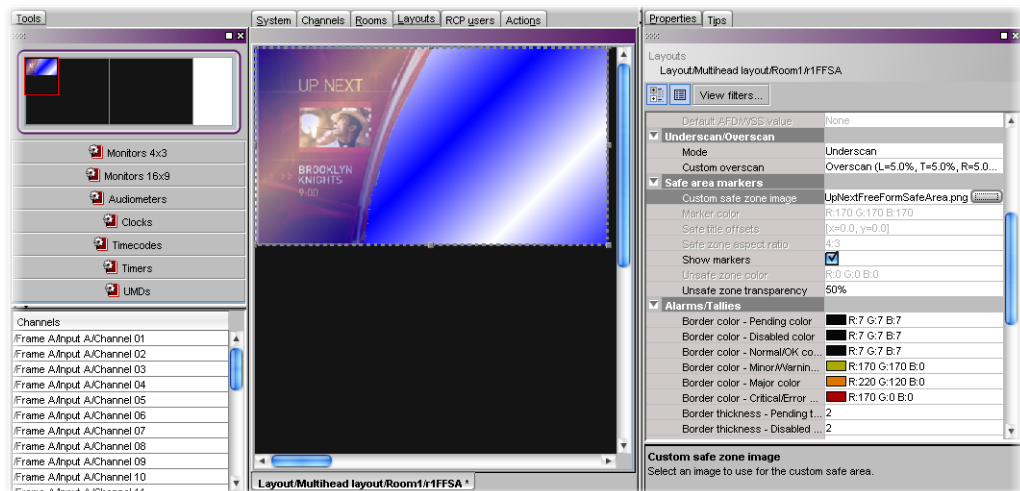

7 To adjust the transparency level of the image, click the **Unsafe zone transparency** box, then move the slider or type the desired transparency value directly in the box. At 0% the portions of the image that correspond to the unsafe area are opaque; at 100% the entire image is transparent.

---

Note: When a custom safe zone image is selected, the following attributes are not available: **Marker color**, **Safe title offsets**, **Safe zone aspect ratio**, and **Unsafe zone color**.

---

## Video Cropping/Zooming

---

Note: The Kaleido-IP does not yet support cropping and zooming.

---

To set the underscan/overscan properties of a video monitor

- 1 In the **Properties** pane, scroll down to the **Underscan/Overscan** section.

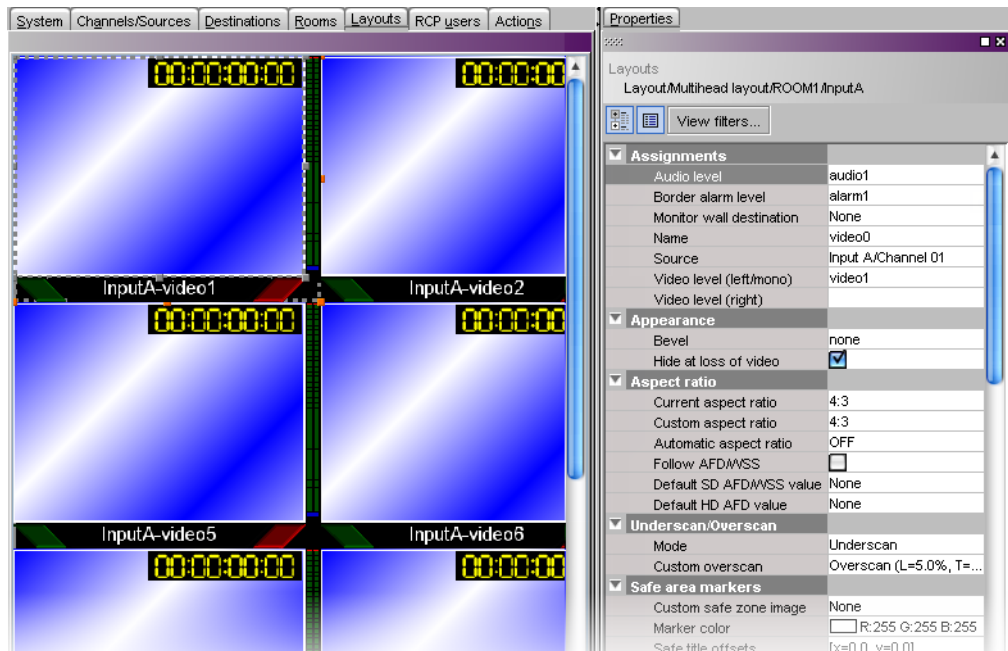

- 2 In the **Mode** list, select **Underscan** (to display the entire video signal) or **Overscan** (to display a cropped video signal).

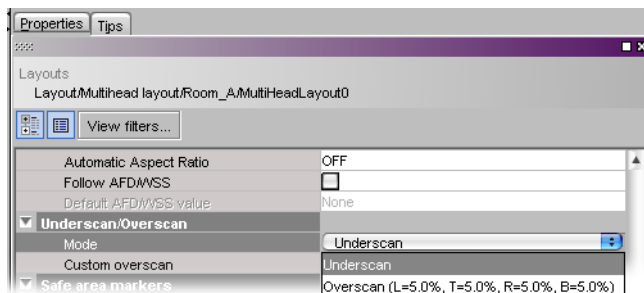

- 3 To specify custom crop settings, click in the white area to the right of **Custom overscan**, then click the button that appears.

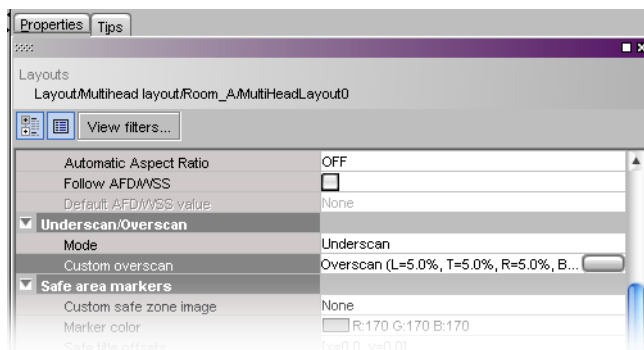

- 4 In the **Custom Overscan** window, specify new percentage values for **Left**, **Right**, **Top**, and **Bottom** overscan margins, then click **OK**.

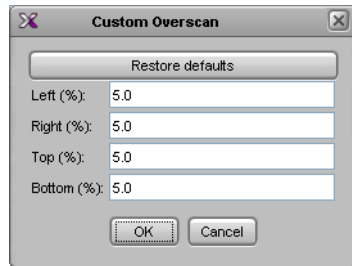

---

**Note:** Generally avoid exceeding 15% in any direction. You can click **Restore defaults** to enter the default overscan values (left, right, top and bottom = 5%). Safe title area and aspect ratio markers follow the video signal (e.g. if the safe title is within 5% of top, left, right and bottom, then when the video is in default overscan mode, the safe title will not appear).

---

When the layout is loaded on the monitor wall, the updated overscan/underscan properties become available.

## Configuring Automatic Aspect Ratios

### To slave a video monitor to the input signal aspect ratio

- In the **Properties** pane, select the appropriate value from the **Automatic Aspect Ratio** list.

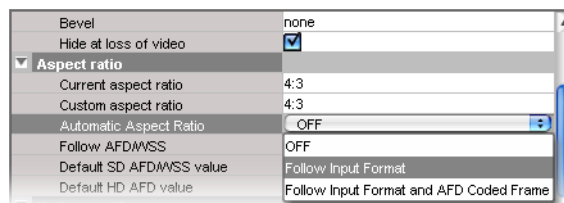

- The default value is **OFF**.
- If the **Automatic Aspect Ratio** property is set to **Follow Input Format**, then the video monitor will change its aspect ratio based on the input feed's format.
- If the **Automatic Aspect Ratio** property is set to **Follow Input Format and AFD Coded Frame**, then the video monitor will change its aspect ratio according to the AFD coded frame. If there is no AFD present, the default value for the current format will be used (see [Configuring the default aspect ratio for HD and SD signals](#), below):
  - the default HD AFD value, if the input is HD;
  - the default SD AFD/WSS value if the input is not HD;
  - if the default value for the current input format is **None**, then the video monitor will change its aspect ratio based on the input feed's format.

---

**Note:** In the case of the Kaleido-IP, aspect ratio information can be extracted and monitored. However, the Kaleido-X software does not yet support automatic aspect ratio adjustment *based on the decoded information* for signals originating from these multiviewers.

---



## Configuring the default aspect ratio for HD and SD signals

To have a video raster follow a video signal's AFD/WSS metadata

- 1 Click to put a check mark in the box labeled **Follow AFD/WSS**.

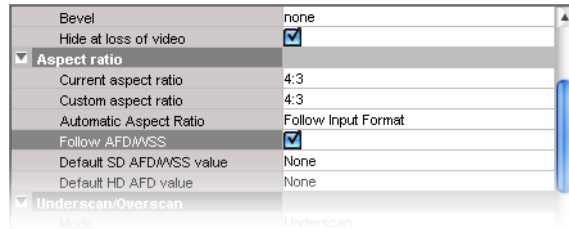

- 2 In the **Default SD AFD/WSS value** list, select the aspect ratio to use when there is no AFD or WSS in an SD signal. Select **Keep Last** to have the video window maintain the last decoded AFD or WSS value if the signal is paused.

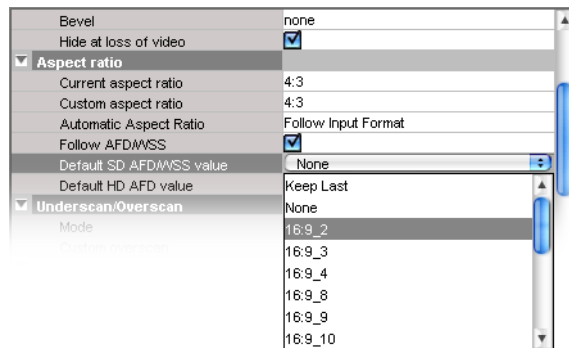

- 3 In the **Default HD AFD value** list, select the aspect ratio to use when there is no AFD or WSS in an SD signal. Select **Keep Last** to have the video window maintain the last decoded AFD value if the signal is paused.

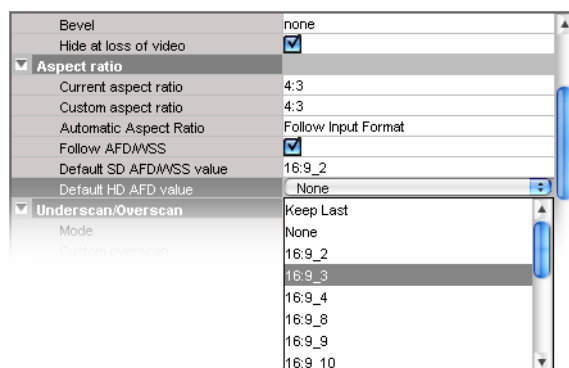

## Configuring a Video Monitor's Alarm Reporting Behavior

To prevent users from missing temporary alarms on the monitor wall, monitors that are capable of displaying an alarm status (e.g. video monitors, subtitling monitors, UMDs, alarm monitors) can be configured with a latching mechanism. An alarm latch will keep the error state visible until someone acknowledges the associated alarm. Video monitors can provide alarm status information through their borders' color and blinking behavior, and show the latched state as small indicators in each corner of the video window. See also: [Configuring a Video Monitor's Source Reporting Behavior](#), on page 246.

### To set the alarm reporting features for a video monitor

- 1 In the **Properties** pane, scroll down to the **Alarms/Tallies** section.



- 2 Set the appropriate border color scheme and associated thickness attributes.
- 3 Click the **Blink mode** box, and then select the appropriate blinking behavior, for your purposes.

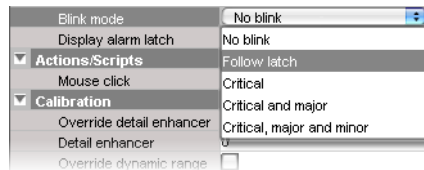

- 4 The Kaleido-X supports the following blinking modes:

Blink mode	Description
Off	The status indicator will never blink.
Follow Latch	The status indicator's blinking will follow the latch status. The indicator will blink until someone unlatches the alarm.
Critical	The status indicator will blink when the current status is critical.
Critical or Major	The status indicator will blink when the current status is critical or major.
Critical, Major and Minor	The status indicator will blink when the current status is critical, major or minor.

- 5 Select the **Display alarm latch** check box to enable the latched status indicators in each corner of the video window.

### Configuring a Video Monitor's Source Reporting Behavior

To help you distinguish which sources are currently active on the monitor wall, monitors that are capable of displaying an alarm status (e.g. video monitors, subtitling monitors, UMDs, alarm monitors) can have their borders, background or text configured to appear in a specific color, based on their current source. Video monitors can provide this information through their borders' color. See also: [Configuring a Video Monitor's Alarm Reporting Behavior](#), on page 245.

## To configure a video monitor's border colors for source reporting

- 1 In the **Properties** pane, scroll down to the **Alarms/Tallies** section.

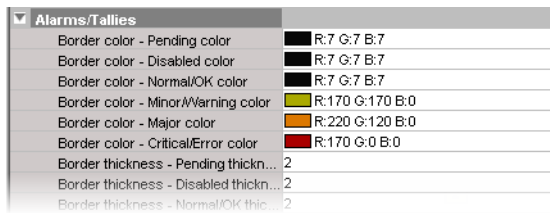

- 2 Set the border thickness attributes as desired.
- 3 Click the border color box for an alarm state you want associated with a distinctive color, based on the monitor's current source.
- 4 Click the button that appeared at the end of the box.

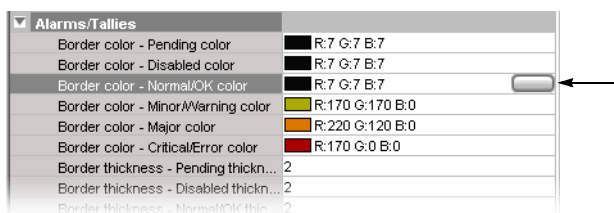

- 5 In **Colors**, select the appropriate level from the **Source color level** list. See [Configuring color level assignments](#) on page 188, for more information.

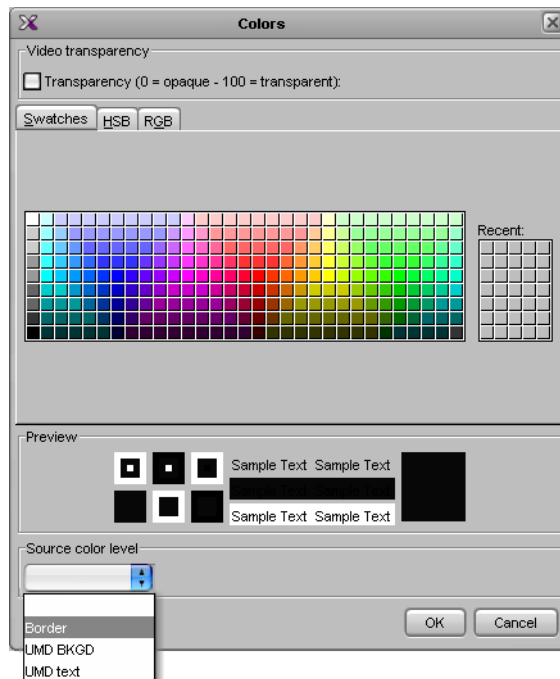

- 6 Set the color's transparency as desired.
- 7 Set the color to be used for sources whose color levels might not be defined, by clicking the tab that corresponds to the color space you wish to use, and then choosing the desired color (see [Configuring a Video Monitor's Alarm Reporting Behavior](#), on page 245, for more information).

8 Click **OK** to close the color picker window.

In the **Properties** pane, the name of the selected source-based color level appears next to the fallback color (and transparency, if used).

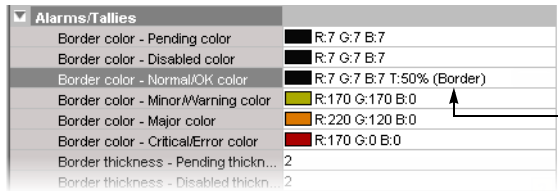

9 Repeat from [step 3](#) for the remaining colors you wish to set.

## Setting a Video Monitor's Text Mode

### Notes

- Closed captioning/subtitling text services can be enabled by purchasing the *CC/XDS* option. In the case of a Kaleido-X, Kaleido-MX, and Kaleido-Modular-X multiviewer system, one license is needed per input card. See [Hardware and Software Options](#) on page 443 for more information.
- The Kaleido-IP supports extraction of CC/subtitling and XDS data (1 license/program). It is not yet possible to enable or verify the *CC/XDS* option in XAdmin's Status and Options page, for this multiviewer model. Contact Technical Support for activation and configuration instructions (see [Contact Us](#), on page 529).
- The KMV-3901/3911, and Kaleido-XQUAD multiviewers do not support extraction of subtitles and closed captions.

### To set the subtitling properties of a video monitor

1 In the **Properties** pane, scroll down to the **CC/Subtitling** section.

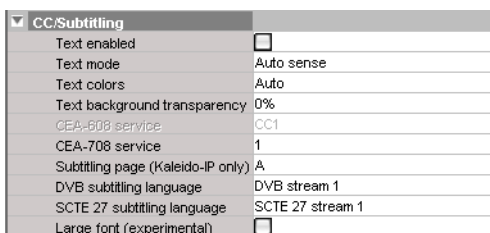

2 Select the **Text enabled** check box.

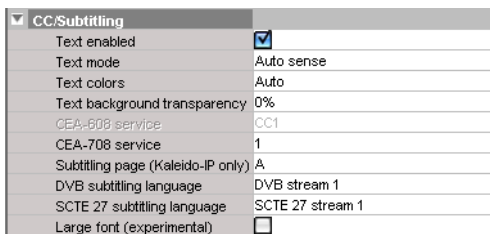

3 Select a value from the **Text mode** list.

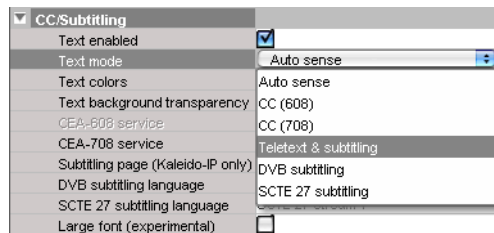

4 Select the appropriate option from the **Text colors** list.

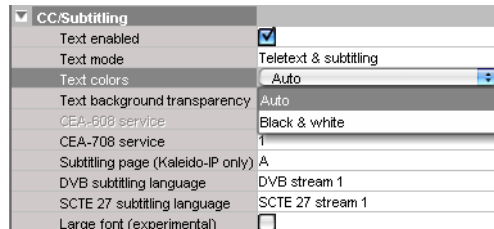

- **Auto:** To display text in colors, as defined in the signal.
- **Black & white:** To display white characters against a black background, regardless of what is specified in the signal.

5 To adjust the transparency level of the text background, click the **Text background transparency** box, and then move the slider, or type the desired transparency value directly in the box.

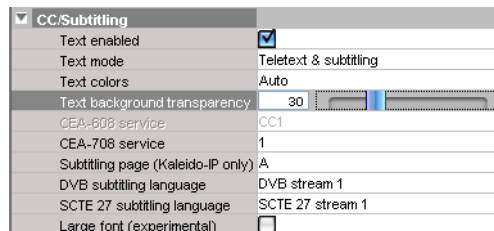

At 0% the text will appear against an opaque background; at 100% the fully transparent background will let the text appear directly against the video. This applies to CEA-608, CEA-708 captions, WST and RDD 8/OP-47 text.

6 Specify a CEA-708 service value, if necessary, and then click **Apply**.

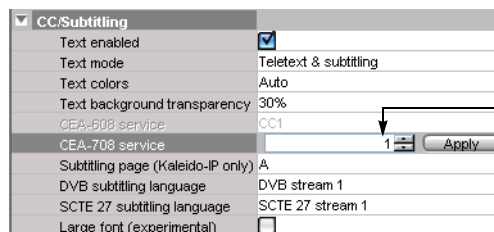

7 In the case of a Kaleido-IP, if you wish to pre-select a specific DVB teletext subtitling language for this monitor, select the desired page from the **Subtitling page** list.

Make sure the selected page is configured (see [Configuring Teletext/Subtitling Page Selection for a Kaleido-IP](#), on page 143). For other multiviewer models, make sure page A remains selected.

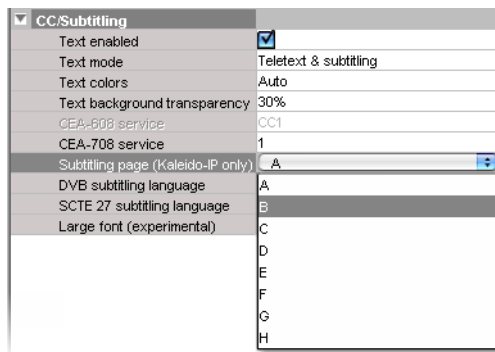

- 8 If you wish to pre-select a specific DVB subtitling language for this monitor, click to expand the **DVB subtitling language** list and then select the appropriate language or DVB stream you wish to monitor.

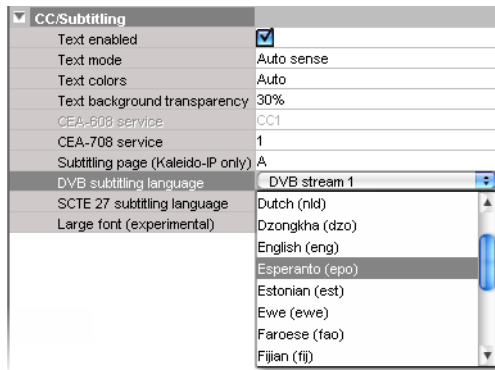

The list of subtitling streams and languages contains the following:

- A series of DVB streams identified by their relative number: **DVB stream 1** to **DVB stream 12**. Choose from this series if you wish to always monitor the third available subtitling stream, for example.
- A list of all supported languages, in alphabetical order based on the English name, which is followed with the corresponding ISO 639-2 alpha-3 code. Choose from this series if you wish to monitor subtitling in a specific language.

When XEdit is connected to the multiviewer, the available languages are indicated in bold text. The ISO 639-2 alpha-3 code for each available language, and the corresponding PID appear in the list of relative subtitling streams.

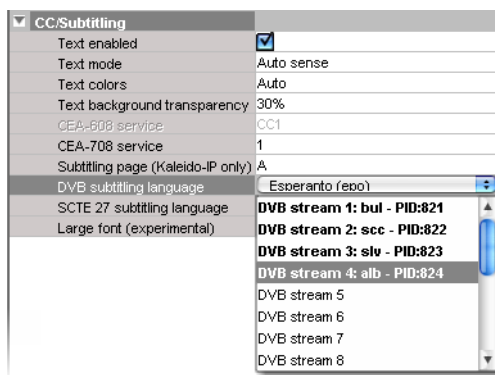

Then, following **DVB stream 12**, for each of the currently available languages, the name, the 3-letter code, and the corresponding PID appear in bold text before the list of all supported languages.

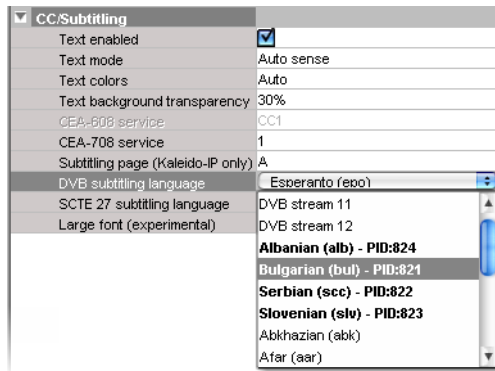

- 9 If you wish to pre-select a specific SCTE 27 subtitling language for this monitor, click to expand the **SCTE 27 subtitling language** list and then select the appropriate language or SCTE 27 stream you wish to monitor.

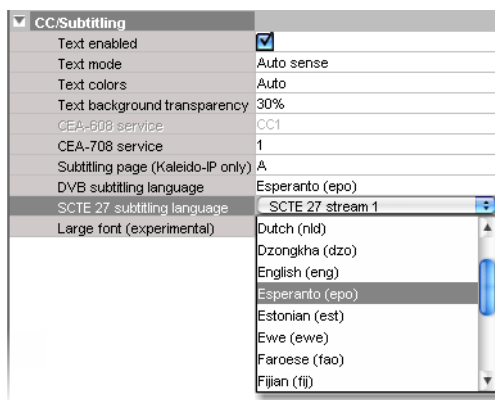

The list of subtitling streams and languages contains the following:

- A series of SCTE 27 streams identified by their relative number: **SCTE 27 stream 1** to **SCTE 27 stream 12**. Choose from this series if you wish to always monitor the third available subtitling stream, for example.
- A list of all supported languages, in alphabetical order based on the English name, which is followed with the corresponding ISO 639-2 alpha-3 code. Choose from this series if you wish to monitor subtitling in a specific language.

When XEdit is connected to the multiviewer, the available languages are indicated in bold text. The ISO 639-2 alpha-3 code for each available language, and the corresponding PID appear in the list of relative subtitling streams.

Then, following **SCTE 27 stream 12**, for each of the currently available languages, the name, the 3-letter code, and the corresponding PID appear in bold text before the list of all supported languages.

---

### Notes

- The current version of the Kaleido-X software supports foreground colors for teletext (WST, OP-47) only. Closed captions (CC, DTVCC) will appear in white against a black background.

Notes (continued)

- If you do not need teletext to be displayed in colors, then you may find that selecting **Black & white** will improve your system's performance.
  - In the case of the Subtitling (WST) text services, the Kaleido-IP supports decoding of up to eight preset pages (page *A* to page *H*) per video signal on the monitor wall. The other multiviewer models support decoding of a single preset page (i.e., page *A*) per video signal.
  - In the case of CEA-608, only CC1 subtitles can be decoded.
  - The current version of the Kaleido-X software supports DVB and SCTE 27 subtitles, from Kaleido-IP sources only.
- 

- 10 If you wish to see CC/subtitling text in a larger, more readable font size, select the **Large font (experimental)** check box.

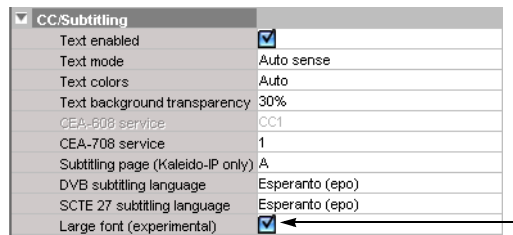

**Note:** The large font option is in a beta stage, and works best with an aspect ratio of 16:9.

---

## Configuring Audio Monitors

**Note:** To decode Dolby E audio metadata, the *Dolby E* option (KXS-DolbyE) is required. See [Enabling Options](#) on page 471, for more information.

---

### To configure an audio monitor

- 1 In the **Layouts** tab, click the audio monitor you wish to configure.
- 2 In the **Properties** pane, click the **Audio scale** box, under **Appearance**, and then select the appropriate audio scale from the list.

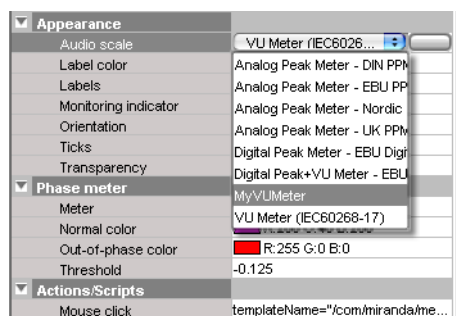

**Note:** See [Configuring Audio Scales](#) on page 256 for more information.

---



- 3 The **Monitoring indicator** check box is selected by default. Audio monitors with a monitoring indicator show by their color that someone is listening to the same audio level. There could be a distinctive color for each of the displays at the site, or one for each room, etc., telling you in more or less details, where the audio is currently being monitored. Clear the check box if you do not need this.

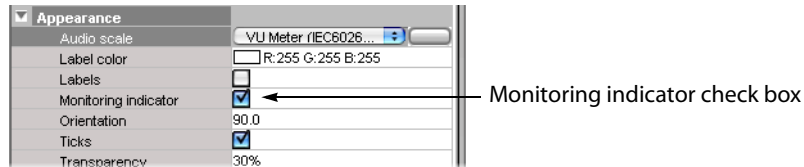

- 4 Under **Assignments**, click the **Audio format** box, and then select the appropriate format from the list: Auto, PCM, Dolby E or Dolby VANC.

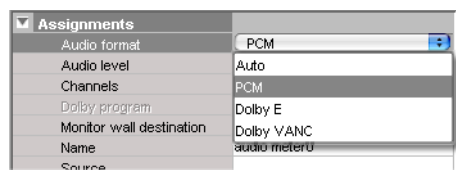

By default, audio monitors added to a layout by using the toolbar button have this attribute set to *Auto*.

#### Notes

- If the actual audio source assigned to this audio monitor is not of the same format configured here, then the audio data will not be shown.
- In the case of a Kaleido-IP, the current version of the Kaleido-X software does not support audio monitors configured to monitor PCM audio signals. For every audio monitor in your layout, the **Audio format** property should be set to **Auto**.

- 5 Choose an **Audio level**.

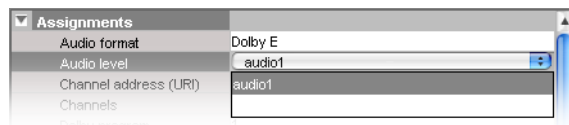

- 6 Choose a value from the **Channels** list to indicate which channel to display.

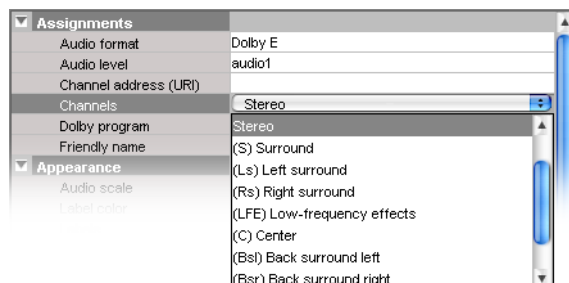

- If the **Audio format** is set to **PCM**, then the available choices are *(L) Left*, *(R) Right*, and *Stereo*.
- If the **Audio format** is set to **Auto**, **Dolby E** or **Dolby VANC**, then the available choices are *(L) Left*, *(R) Right*, *Stereo*, *(S) Surround*, *(Ls) Left surround*, *(Rs) Right*

*surround, (LFE) Low-frequency effects, (C) Center, (Bsl) Back surround left, (Bsr) Back surround right, (Le) Left extra and (Re) Right extra.*

- 7 If your monitoring purposes may involve decoding Dolby audio metadata, then select the appropriate program number (1–8) from the **Dolby program** list.

---

**Note:** The number of programs included in a Dolby metadata bit stream depends on the program configuration. For example, a Dolby E stream with the 7.1 program configuration only has one program available for selection in its metadata bit stream; a 5.1+2 stream has two programs; a 8x1 stream has eight program selections possible.

---

- 8 Make the appropriate assignments (see [Assigning Logical Sources or Monitor Wall Destinations to Monitors](#), on page 232).
- 9 Set the other attributes, as needed (see [Creating Actions](#), on page 301 for more information).

▼ <b>Assignments</b>	
Audio format	PCM
Audio level	audio1
Channels	Stereo
Dolby program	1
Monitor wall destination	None
Name	audio meter0
Source	Input_A/Channel 01
▼ <b>Appearance</b>	
Audio scale	VU Meter (IEC60268-17)
Label color	<input type="checkbox"/> R:255 G:255 B:255
Labels	<input checked="" type="checkbox"/>
Monitoring indicator	<input checked="" type="checkbox"/>
Orientation	90.0
Ticks	<input checked="" type="checkbox"/>
Transparency	30%
▼ <b>Phase meter</b>	
Meter	<input checked="" type="checkbox"/>
Normal color	<input type="checkbox"/> R:200 G:40 B:200
Out-of-phase color	<input type="checkbox"/> R:255 G:0 B:0
Threshold	-0.125
▼ <b>Actions/Scripts</b>	
Mouse click	templateName="/com/miranda/me...

- 10 On the **File** menu, click **Save**.

## Configuring Loudness Monitors

### To configure a loudness monitor

- 1 In XEdit, click the **Layouts** tab, and then open the desired layout.
- 2 Unlock the appropriate composite monitor if applicable (see [Unlocking a Composite Monitor](#), on page 295).
- 3 Click the loudness monitor you wish to configure.

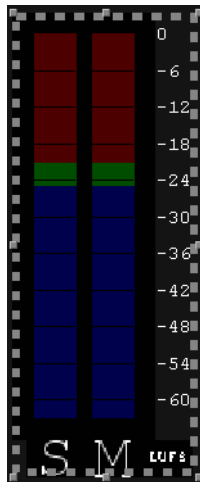

- 4 In the **Properties** pane, click the **Audio scale** box, under **Appearance**, and then select the appropriate audio scale from the list.

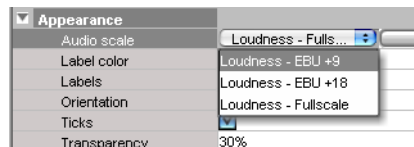

Three predefined audio scales are available for loudness monitors:

- Full scale (default)
- EBU +9
- EBU +18

---

Note: The audio scales applicable to loudness monitors have fixed upper and lower limits. Only the colors of the can be changed (see [Configuring Audio Scales](#), on page 256).

---

- 5 Choose the **Audio level** you wish to monitor.

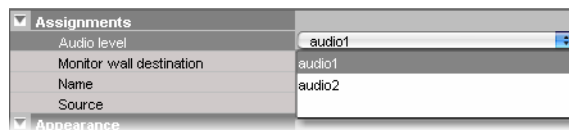

---

Note: The selected audio level must be associated with an *audio program* (not with an embedded audio pair). See [Audio program](#) on page 122.

---

- 6 Make the appropriate source and destination assignments (see [Assigning Logical Sources or Monitor Wall Destinations to Monitors](#), on page 232).
- 7 Set the other attributes, as needed (see [Creating Actions](#), on page 301 for more information).

▼ <b>Assignments</b>	
Audio level	audio1
Monitor wall destination	None
Name	loudness0
Source	
▼ <b>Appearance</b>	
Audio scale	Loudness - Fullscale
Label color	<input type="checkbox"/> R:255 G:255 B:255
Labels	<input checked="" type="checkbox"/>
Orientation	90.0
Ticks	<input checked="" type="checkbox"/>
Transparency	30%
▼ <b>Actions/Scripts</b>	
Mouse click	

8 On the **File** menu, click **Save**.

## Configuring Audio Scales

You can configure audio scales in two ways: either globally, from the **Tools** menu, or by clicking a specific audio monitor in a layout.

### Configuring Audio Scales from the Tools Menu

To configure an audio scale from the **Tools** menu

- 1 On the **Tools** menu, click **Edit audio scales**:

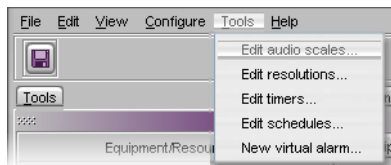

The **Edit Audio Scale** window appears.

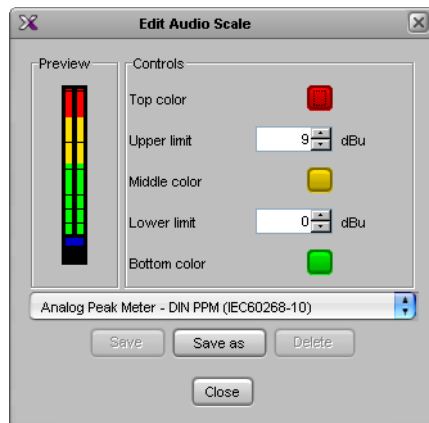

- 2 Select the audio scale you wish to customize (or the one on which you wish to base a new audio scale), from the list at the bottom of the window.

---

**Note:** When you modify one of the default audio scales, you can only save your changes as a new audio scale. On the other hand, custom audio scales can be tweaked and saved repeatedly until the desired configuration is achieved.

---

- 3 Click one of the **Top**, **Middle** or **Bottom Color** buttons to set the top, middle and bottom color.

The color picker window appears.

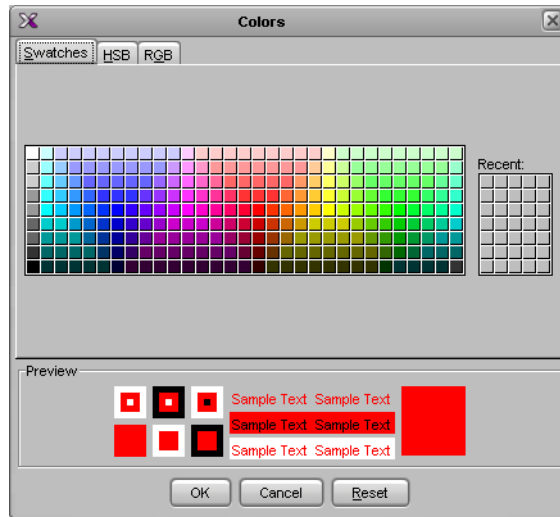

- 4 In **Colors**, click the tab that corresponds to the color space you wish to use, and then choose the desired color.  
Swatches in the selected color appear under **Preview**.
- 5 Click **OK** to close the color picker window.  
In **Edit Audio Scale**, the corresponding button and the corresponding part of the audio monitor preview show the selected color.
- 6 Repeat the procedure until all three colors are set as desired.
- 7 Enter the audio thresholds in **Upper limit** and **Lower limit**.
- 8 Type a name for the new audio scale in the box at the bottom, and then click the **Save as** button. Alternatively, if you are modifying an existing custom audio scale, you can click the **Save** button.

## Configuring an Audio Scale from a Specific Audio Monitor

To configure an audio scale from a specific audio monitor

- 1 In the **Layouts** tab, click the audio monitor you wish to configure.
- 2 In the **Properties** pane, click the **Audio scale** box, under **Appearance**, and then click the button that appeared at the end of the box.  
The **Edit Audio Scale** window appears.

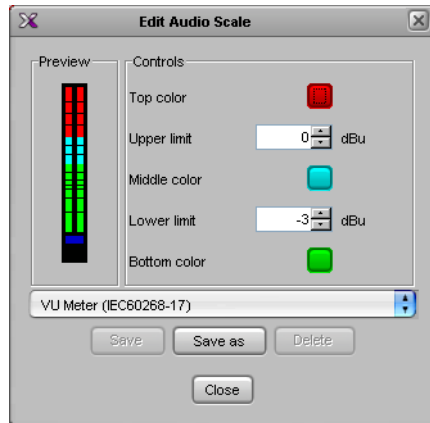

- 3 Click one of the **Top**, **Middle** or **Bottom Color** buttons to set the top, middle and bottom color.

The color picker window appears.

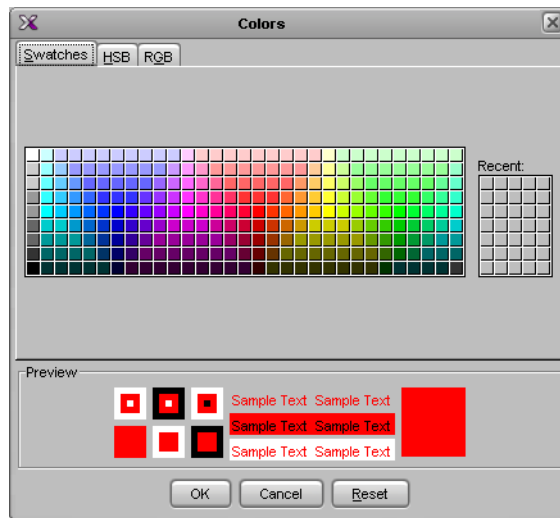

- 4 In **Colors**, click the tab that corresponds to the color space you wish to use, and then choose the desired color.  
Swatches in the selected color appear under **Preview**.
- 5 Click **OK** to close the color picker window.  
Swatches in the selected color appear under **Preview**.
- 6 Click **OK** to close the **Choose Background Color** window.  
In **Edit Audio Scale**, the corresponding button and the corresponding part of the audio monitor preview show the selected color.
- 7 Repeat the procedure until all three colors are set as desired.
- 8 Enter the audio thresholds in **Upper limit** and **Lower limit**.

- 9 Type a name for the new audio scale in the box at the bottom, and then click the **Save as** button.

---

**Note:** When you modify one of the default audio scales, you can only save your changes as a new audio scale. On the other hand, custom audio scales can be tweaked and saved repeatedly until the desired configuration is achieved.

---

## Removing Audio Scales from the System

To remove a custom audio scale from the system

- 1 On the **Tools** menu, click **Edit audio scales**.

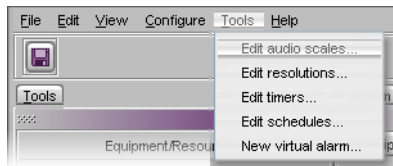

The **Edit Audio Scale** window appears.

- 2 In **Edit Audio Scale**, select the custom scale you wish to remove, from the list at the bottom of the window, and then click **Delete**.

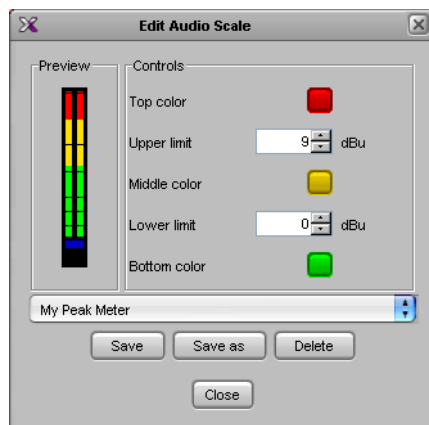

---

**Note:** The default audio scales cannot be removed from the system.

---

## Configuring Time Code Monitors

To configure a time code monitor in a layout

- 1 To add a time code monitor to a layout, click the "Time code monitor" button  on the toolbar, and then click and drag to draw a time code monitor on the layout.  
Alternatively, you can drag a time code monitor from a widget library to the layout.
- 2 Click the time code monitor you wish to configure.  
The time code's attributes appear in the **Properties** pane.

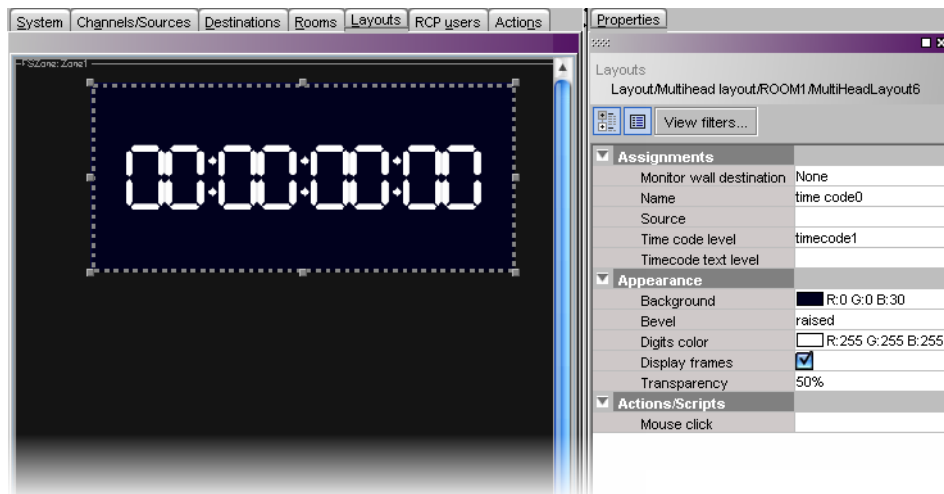

- To replace the default name, type a new name in the **Name** box.

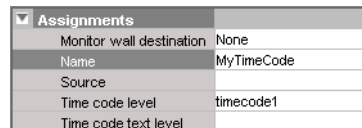

- If you wish to assign a logical source, drag the appropriate element from the **Channels/Sources** list that appears in the **Tools** pane, to the time code monitor.

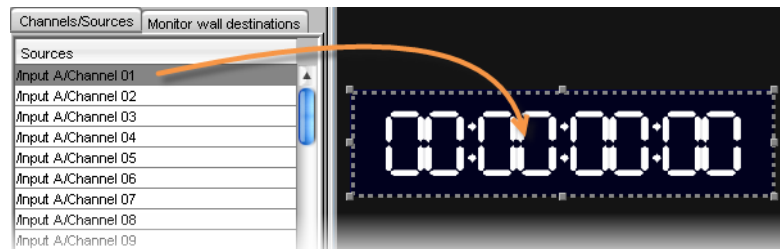

The selected logical source's name appears in the **Source** box.

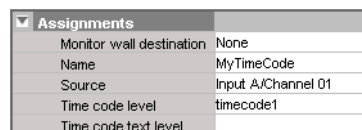

---

**Note:** The first time code level applies by default. If your system's logical sources include more than one time code level, select the one you wish to apply from the **Time code level** list.

---

- If you wish to assign time code information from an external provider (see [Configuring logical sources based on external alarm providers](#), on page 187), then select the appropriate text level from the **Time code text level** list.



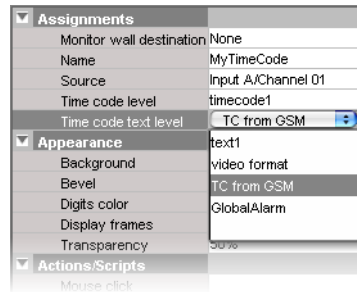

If the time code monitor is configured with both a time code level and a text level, it will show the most recently updated value (i.e., if the multiviewer received time code data, followed by a text update from the GSM, then the monitor will display the GSM alarm text). If a text value from the GSM does not meet the supported formats, then the value is ignored. The supported formats are:

- HH:MM:SS (showing the hours, minutes, and seconds, as 2-digit values)
- HH:MM:SS:FF (showing the hours, minutes, seconds, and frames, as 2-digit values)
- HH:MM:SS;FF (showing the hours, minutes, seconds, and drop frames, as 2-digit values)

---

**Note:** With the current implementation of this feature, you may observe a 200-270 ms delay, depending on your multiviewer system topology, and on the network load.

---

## Configuring Timers

Building a countdown timer involves defining the timer itself (name, behavior, time reference, etc.), and then creating one or more timer monitors to display the timer on a monitor wall. Timers can be created, modified, deleted, added to a layout, assigned to logical sources, rooms or individual RCP users, and controlled from the Kaleido-RCP2.

---

**Note:** In addition to timer monitors, Gateway commands can be used to interact with timers. Refer to the *Kaleido Remote Control Protocol (Gateway)* guide for details.

---

## Adding Timers to the System

### To define a timer

- 1 On the **Tools** menu, click **Edit timers**.

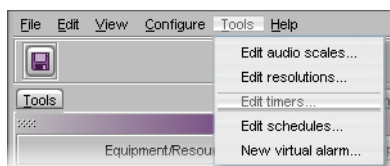

- 2 In **Timer Editor**, click **New**.

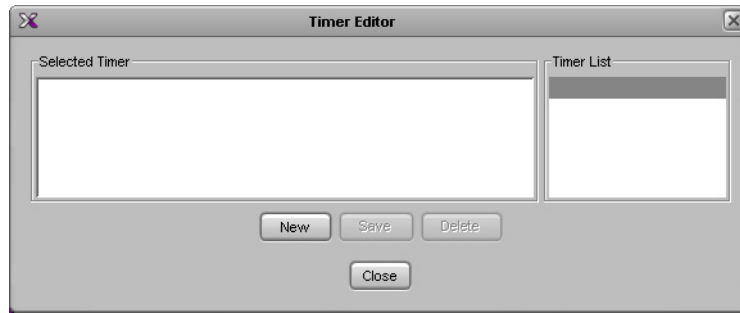

3 Type a name for your new timer in the **Timer name** box.

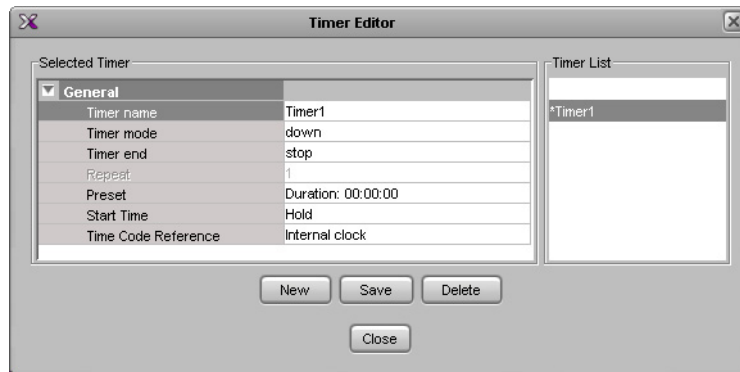

4 Choose the appropriate mode, from the **Timer mode** list.

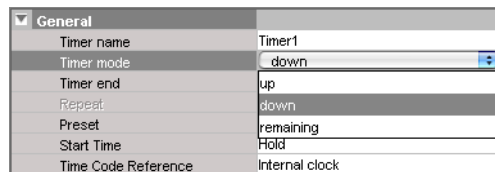

- **Up:** The timer counts up starting from zero up to the Preset time.
- **Down:** The timer counts down from the Preset time to zero.
- **Remaining:** The timer counts down from the current time until it reaches the Preset time. This mode is a one-shot mode—the timer will not automatically restart the next day at the same start time. To restart it, you must either reset the timer monitor on the monitor wall, or set and specify a new start time.

5 Choose what happens when the timer reaches the end of its countdown period, from the **Timer end** list.

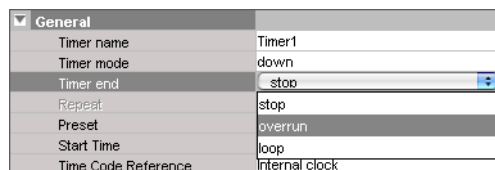

- **Loop:** The timer restarts and repeats its cycle (not available with the **Remaining** timer mode).
- **Stop:** The timer stops.
- **Overrun:** The timer counts through its specified end point, and then continues (when **Overrun** is specified, the timer always counts up).

- 6 If you chose **Loop** as a timer end mode, specify the number of times the loop should repeat.

General	
Timer name	Timer1
Timer mode	down
Timer end	loop
Repeat	1
Preset	Duration: 00:00:00
Start Time	Hold
Time Code Reference	Internal clock

- 7 Specify a **Preset** duration.

General	
Timer name	Timer1
Timer mode	down
Timer end	loop
Repeat	1
Preset	Duration: 00:00:00
Start Time	Hold
Time Code Reference	Internal clock

- 8 Specify a **Start time**.

General	
Timer name	Timer1
Timer mode	down
Timer end	loop
Repeat	1
Preset	Duration: 00:00:00
Start Time	Hold 6/5/08 6:20 PM
Time Code Reference	Hold

- 9 Choose a synchronization source from the **Time code reference** list— either an embedded time code signal from a video source, an LTC input (if available), or the internal clock time (default).

General	
Timer name	Timer1
Timer mode	down
Timer end	loop
Repeat	1
Preset	Duration: 00:00:00
Start Time	Hold
Time Code Reference	<ul style="list-style-type: none"> <li>System               <ul style="list-style-type: none"> <li>Kaleido-X (7RU)                   <ul style="list-style-type: none"> <li>INPUT A - KXI-16</li> <li>INPUT B - KXI-16</li> <li>INPUT C - KXI-16</li> <li>INPUT D - KXI-16</li> <li>INPUT E - KXI-16</li> <li>INPUT F - KXI-16</li> <li>OUTPUT A - KXO-DUA                       <ul style="list-style-type: none"> <li>LTC 1</li> <li>LTC 2</li> <li>LTC 3</li> </ul> </li> <li>OUTPUT B - KXO-DUA</li> <li>OUTPUT C - KXO-DUA</li> <li>OUTPUT D - KXO-DUA</li> </ul> </li> </ul> </li> </ul>

### IMPORTANT

**Before setting a timer's start time in XEdit, review the following:**

- If the selected time code reference *includes time zone information*, then make sure that the PC or laptop that has XEdit is configured for the same time zone.

- If the selected time code reference *does not include time zone information*, or you chose to bind the timer to the multiviewer's *internal clock*, then the multiviewer's system time will apply.
  - In the case of a Kaleido-X or Kaleido-X16 multiviewer model, make sure the time zone settings are the same, on the multiviewer, and on the PC or laptop that has XEdit.
  - In the case of a KMV-3901/3911, when you save or export the timer to the multiviewer, XEdit automatically converts the start time you specified to UTC, based on your computer's time zone settings.

**Note:** In the case of a Kaleido-X or Kaleido-X16 multiviewer model, the system's time zone is configured in XAdmin. In the case of a KMV-3901/3911, time is always based on UTC. On a Windows PC or laptop, the time zone is configured in the Date and Time control panel.

- 10 Click **Save** to save your new timer and close the **Timer Editor** window.
- 11 Under the **Channels/Sources** tab, create a new logical source to associate with the timer, and name it.

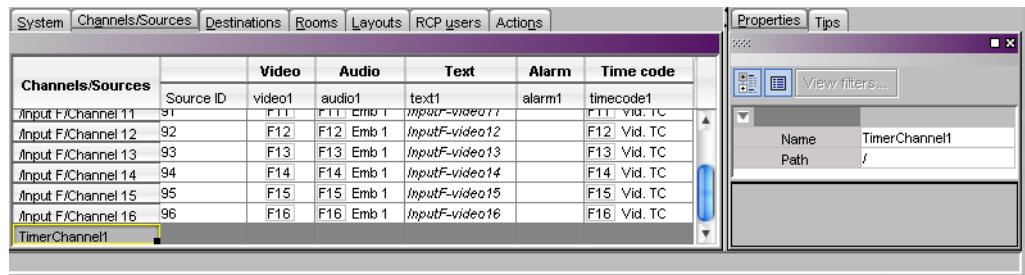

- 12 Click a cell in the time code level of the new logical source, and drag the timer you wish to assign to this logical source from the filtered System list that appears in the **Tools** pane, to the selected cell in the sources table.

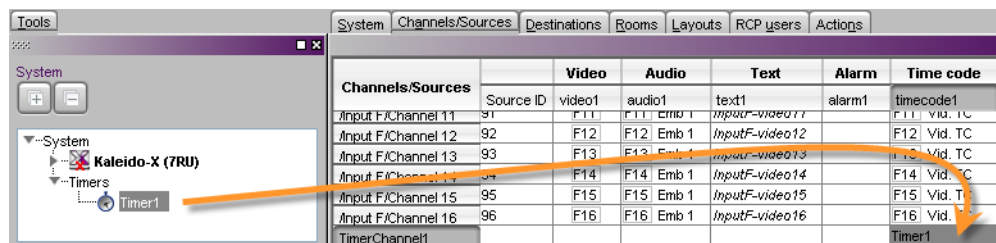

- 13 Click **Save**.

## Adding a Timer Monitor to a Layout

### To create a timer monitor

- 1 In XEdit, open a layout and click the Timer button .
- 2 Click and drag to draw a timer monitor on the layout.

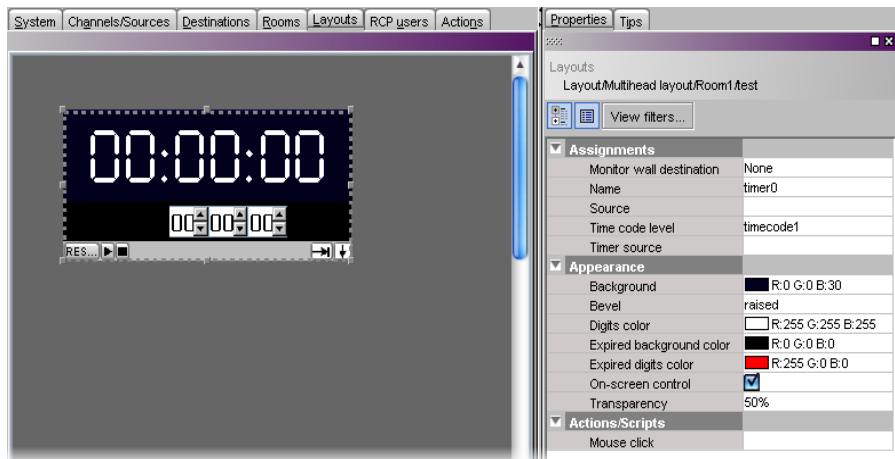

Alternatively, you can drag a timer monitor from the Timers library to the layout. The timer's attributes appear in the **Properties** pane.

- 3 Replace the default name, by typing a new name in the **Name** box.

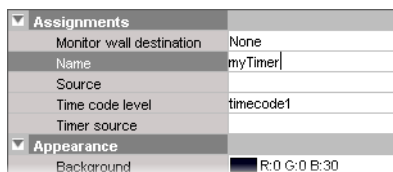

- 4 If you wish to assign a logical source, drag the appropriate element from the **Channels/Sources** list that appears in the **Tools** pane, to the timer monitor.

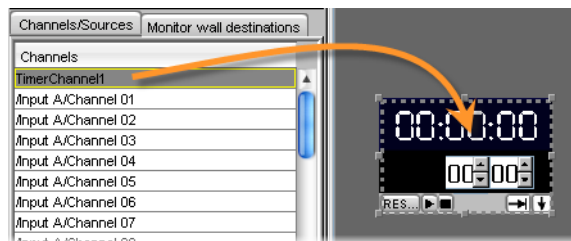

The selected logical source's name appears in the **Source** box, and the **Timer source** box shows the value of the corresponding time code level.

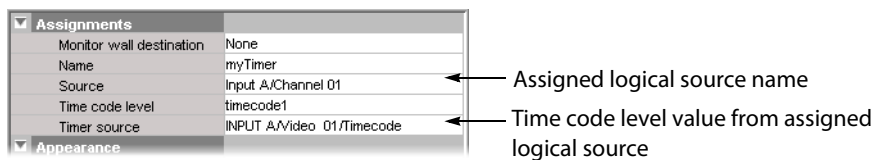

**Note:** The first time code level applies by default. If your system's logical sources include more than one time code level, select the one you wish to apply from the **Time code level** list.

- 5 Click the button beside **Timer source**.

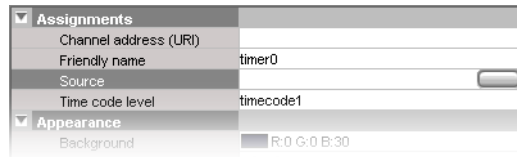

The **Timer Editor** window appears.

- 6 Choose a timer (see [Configuring Timers](#), on page 261) from the **Timer List**.

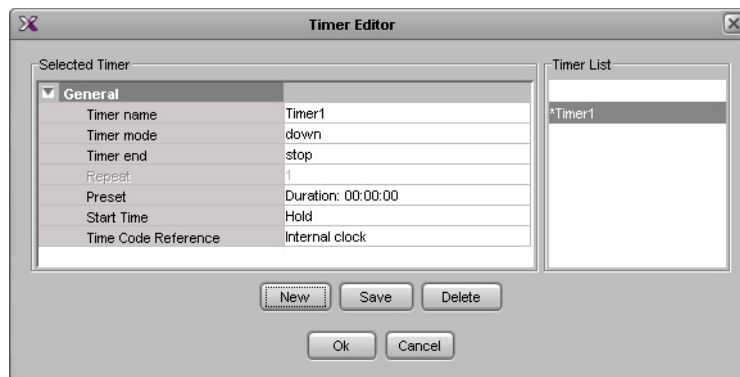

It is also possible to assign a timer to a timer monitor by dragging an existing logical source (containing a timer assignment) to the monitor.

---

**Note:** Each timer monitor is assigned to exactly one timer. Multiple timer monitors can be assigned to the same timer. Start/stop/reset or mode changes applied to one monitor affect all other monitors assigned to the same timer.

---

- 7 Click **Save**.
- 8 Modify the timer's **Appearance** properties as needed.

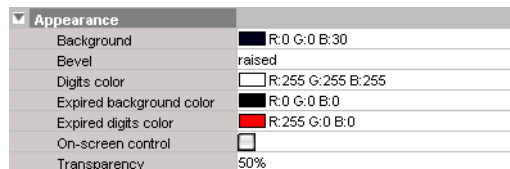

- 9 To attach an action to the timer, click the button beside **Mouse click**.



The **Action Editor** window appears.

- 10 Drag an action from the left pane to the middle pane, then specify the action's behavior in the right pane.

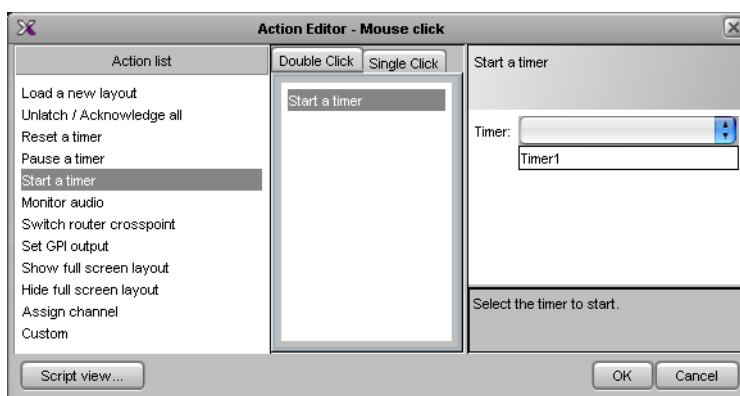

For more information on creating actions, refer to [Creating Actions](#), on page 301.

- 11 Click **OK** to save the action assignment and close the **Action Editor** window.
- 12 Click **Save** to save the layout with the new timer monitor.
- 13 Export the database to a Kaleido-X, and load the layout.

The interactive timer monitor appears on the monitor wall. See [Using Timers](#) on page 57, [Assigning a Timer to a Room](#), on page 316, and [Assigning a Timer to an RCP User](#), on page 320, for more information.

## Configuring UMDs

UMDs can serve various purposes: in addition to displaying the name of the video source seen in a video monitor, they can report operational status and error conditions in real time, by showing dynamic alarm and text attributes associated with a source.

### To configure a UMD

- 1 In XEdit, click the **Layouts** tab, and then open the desired layout.
- 2 Unlock the appropriate composite monitor if applicable (see [Unlocking a Composite Monitor](#), on page 295).
- 3 Click the UMD you wish to configure.
- 4 To pre-assign a logical source to be monitored by default, to configure the selected UMD as a monitor wall destination, or to configure its reporting behaviors, see:
  - [Assigning Logical Sources or Monitor Wall Destinations to Monitors](#), on page 232.
  - [Setting Monitored Alarm and Text Levels for a UMD](#), on page 268.
  - [Configuring a UMD's Alarm Reporting Behavior](#), on page 268.
  - [Configuring a UMD's Source Reporting Behavior](#), on page 270.
- 5 To configure UMD text properties, see:
  - [Configuring Static UMD Text](#), on page 272.
  - [Configuring Dynamic UMD Text](#), on page 272.
  - [Setting the Text Font](#), on page 273.
- 6 Click outside the composite monitor to lock it, if applicable.
- 7 On the **File** menu, click **Save**.

## Setting Monitored Alarm and Text Levels for a UMD

When a system's logical sources include more than one level under a given category, the first level is selected by default for monitoring. In the case of a UMD, you may change the alarm levels associated with the UMD itself and with its left and right tallies, and the text level from which the UMD label will be retrieved.

### To change the default alarm and text levels selected for a UMD

- 1 To monitor a different alarm level, or the source's global alarm, select the appropriate level from the **UMD alarm level** list.

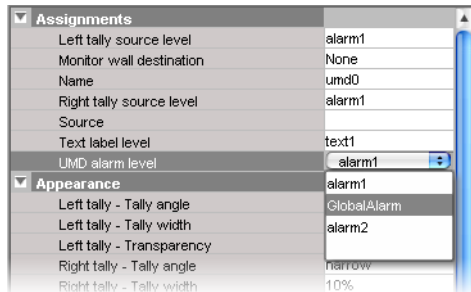

- 2 To have the UMD report alarm text (or other dynamic text), select the desired level from the **Text label level** list.

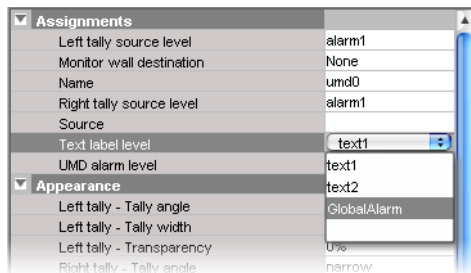

See [Configuring Dynamic UMD Text](#) on page 272, for more information.

- 3 If you wish to monitor tallies, select the desired levels from the **Left tally source level**, and **Right tally source level** lists.

See [Tally Interface Devices & Timer Systems](#) on page 375, for examples of such configurations.

## Configuring a UMD's Alarm Reporting Behavior

To prevent users from missing temporary alarms on the monitor wall, monitors that are capable of displaying an alarm status (e.g. video monitors, subtitling monitors, UMDs, alarm monitors) can be configured with a latching mechanism. An alarm latch will keep the error state visible until someone acknowledges the associated alarm. For UMDs, the latch color can be set to follow the background or the text color configuration. See also: [Configuring a UMD's Source Reporting Behavior](#), on page 270.

### To set the alarm reporting features for a UMD (text and tallies)

- 1 In XEdit, open a layout and click the UMD whose alarm reporting behavior you wish to configure.

---

**Note:** Double-click the UMD, if it is part of a composite monitor.

---



- 2 If you wish to use the UMD's alarm latching mechanism, make sure the UMD is configured with a bevel.

In the **Properties** pane, the **UMD bevel** attribute should be set to either *lowered*, or *raised*.

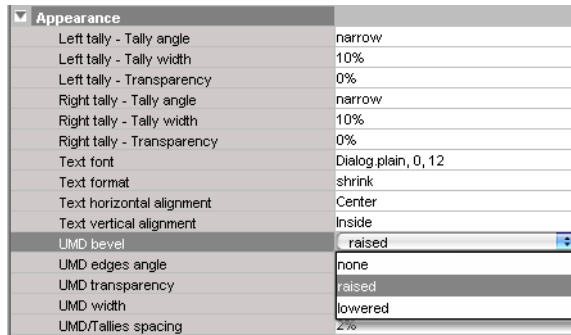

- 3 Scroll down to the **Alarms/Tallies** section, in the **Properties** pane, to set the appropriate text and background color scheme.

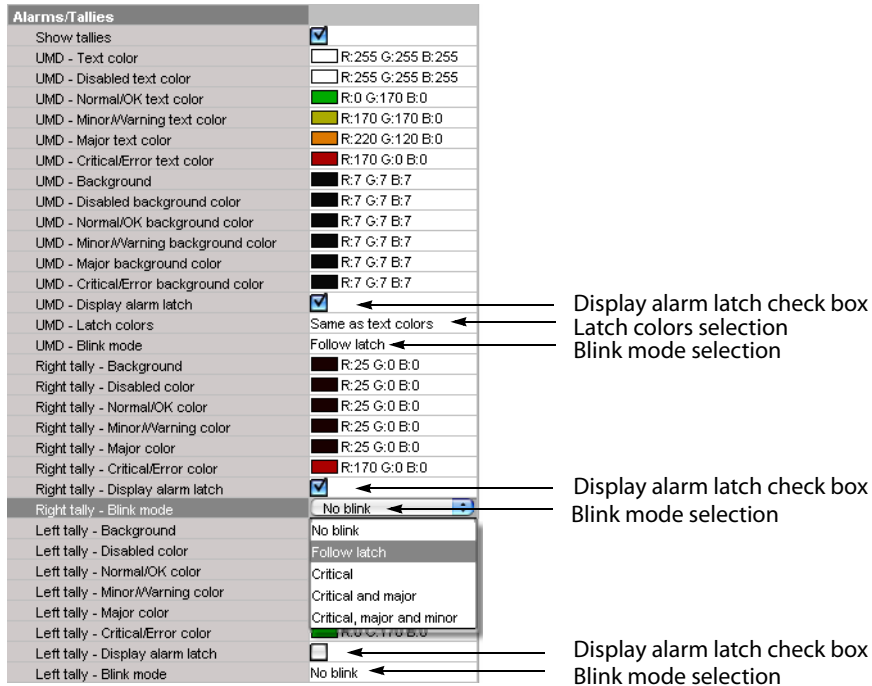

- 4 Click the **Blink mode** boxes, and then select the appropriate blinking behavior, for your purposes:

Blink mode	Description
<b>Off</b>	The status indicator will never blink.
<b>Follow latch</b>	The status indicator's blinking will follow the latch status. The indicator will blink until someone unlatches the alarm.
<b>Critical</b>	The status indicator will blink when the current status is critical.

Blink mode	Description
<b>Critical and major</b>	The status indicator will blink when the current status is critical or major.
<b>Critical, major and minor</b>	The status indicator will blink when the current status is critical, major or minor.

- 5 Select the **Display alarm latch** check box to enable the latched status indicators.

### Configuring a UMD's Source Reporting Behavior

To help you distinguish which sources are currently active on the monitor wall, monitors that are capable of displaying an alarm status (e.g. video monitors, subtitling monitors, UMDs, alarm monitors) can have their borders, background or text configured to appear in a specific color, based on their current source. UMDs can provide this information through their text and background colors. See also: [Configuring a UMD's Alarm Reporting Behavior](#), on page 268.

#### To configure a UMD's background or text colors for source reporting

- 1 In XEdit, open a layout and click the UMD whose source reporting behavior you wish to configure.

Note: Double-click the UMD, if it is part of a composite monitor.

- 2 In the **Properties** pane, scroll down to the **Alarms/Tallies** section.

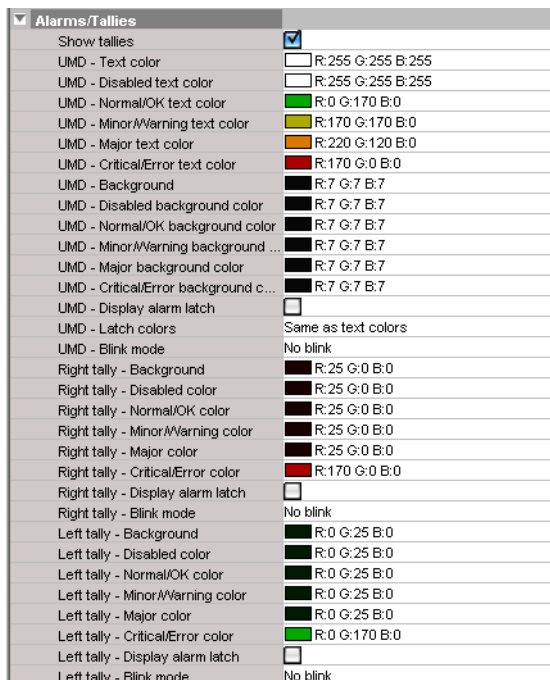

- 3 Click the text or background color box for a state you want associated with a distinctive color, based on the monitor's current source.
- 4 Click the button that appeared at the end of the box.

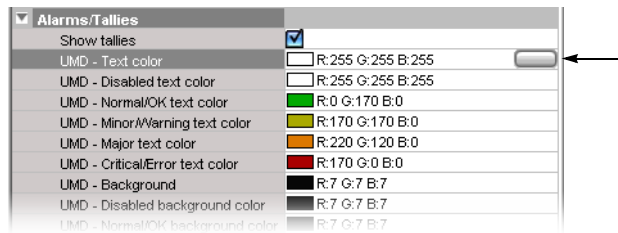

- In **Colors**, select the appropriate level from the **Source color level** list. See [Configuring color level assignments](#) on page 188, for more information.

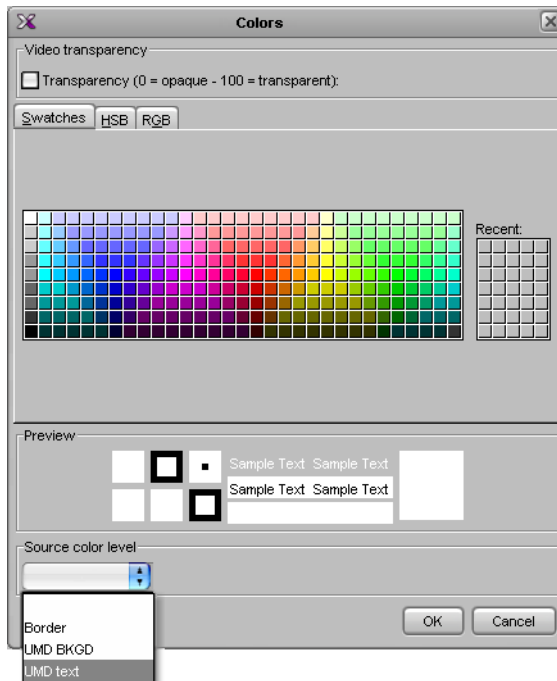

- Set the color's transparency as desired.
- Set the color to be used for sources whose color levels might not be defined, by clicking the tab that corresponds to the color space you wish to use, and then choosing the desired color (see [Configuring a UMD's Alarm Reporting Behavior](#), on page 268, for more information).
- Click **OK** to close the color picker window.

In the **Properties** pane, the name of the selected source-based color level appears next to the fallback color (and transparency, if used).

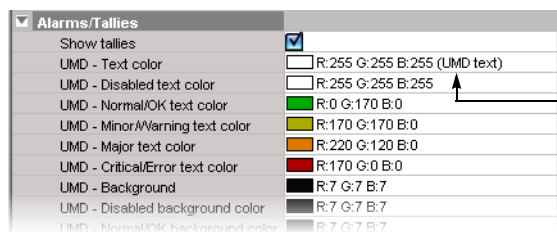

- Repeat from [step 3](#) for the remaining colors you wish to set.

## Configuring Static UMD Text

A UMD can show two types of static text:

- static text that you typed directly on a layout, in XEdit (see below), or on the monitor wall (see [Editing UMD Text](#), on page 50);
- static text associated with the current logical source assigned to the UMD, which you entered in the sources table.

In the first case, the static text is tied to a specific layout whereas, in the other case, the text is tied to a specific input signal.

### To configure static text for a specific UMD in a layout

- 1 In the **Layouts** tab, double-click the UMD whose static text you wish to set.
- 2 Make sure the appropriate input language and method are set in your operating system.
- 3 Type the desired static text.

### To configure static UMD text from the sources table

- 1 In the **Channels/Sources** tab, click the cell that corresponds to the appropriate text level of the logical source that is assigned to the UMD whose static text you wish to set.
- 2 Type the new static text.

## Configuring Dynamic UMD Text

Assuming you have created logical sources (see [Creating and Configuring Logical Sources](#), on page 178) and a layout in XEdit, you can further configure UMDs in your layout to report dynamic text labels, associated with the sources you wish to monitor.

### To configure dynamic UMD text

- 1 In the **Channels/Sources** tab, click a cell that corresponds to the appropriate text level of a logical source.
- 2 In the filtered System list, navigate to the text element you wish to monitor, and drag it onto the selected cell.

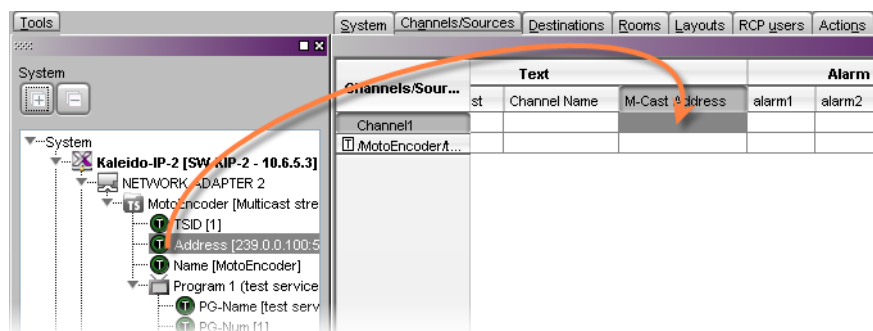

- 3 Make corresponding assignments to other logical sources by incremental copy, if desired (see [Making Further Assignments by Incremental Copy](#), on page 189).
- 4 On the **File** menu, click **Save**.  
Changes to the sources table are saved.
- 5 Click the **Layouts** tab, and then open the layout you wish to configure.

- 6 Unlock the appropriate composite monitor if applicable (see [Unlocking a Composite Monitor](#), on page 295), and then click the UMD whose dynamic text reporting behavior you wish to set.
- 7 In the **Properties** pane, click the **Text label level** box, and then select the text level you configured in [step 2](#).

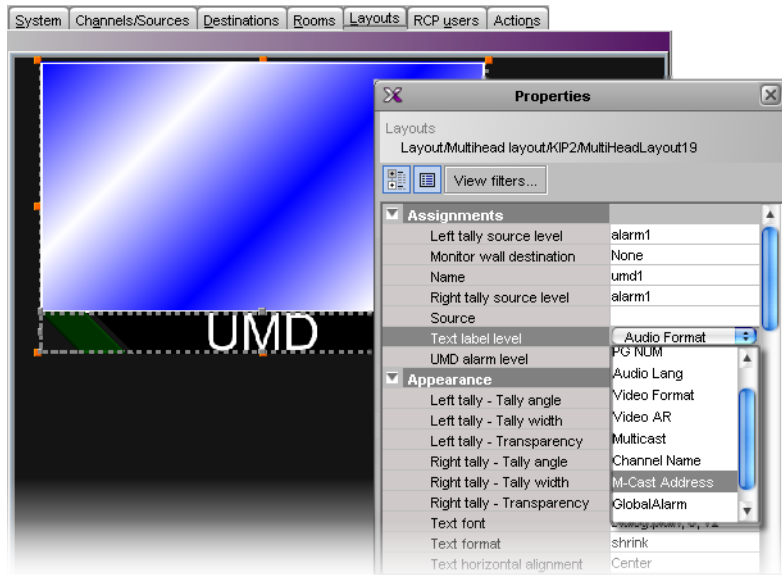

- 8 Click outside the composite to lock it, if applicable.
- 9 Repeat [step 6](#) – [step 8](#) until you have configured all UMDs that are to display dynamic text when this layout is loaded on the monitor wall.
- 10 On the **File** menu, click **Save**.

## Setting the Text Font

### To set the text font for a UMD in a layout

- 1 In the **Layouts** tab, click the UMD whose text font you wish to set.
- 2 In the **Properties** pane, click the **Text font** box, under **Appearance**, then click the button that appeared at the end of the box.

The **Select a Font** window appears.

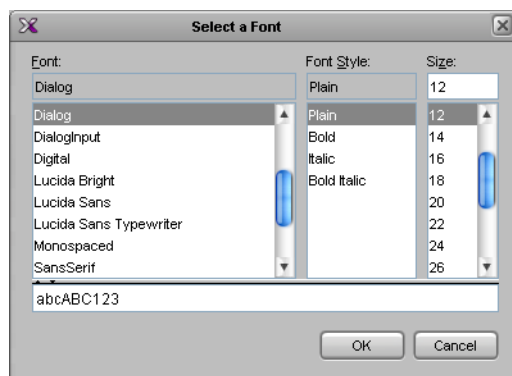

- 3 Select the appropriate values from the **Font**, **Font Style** and **Size** lists.

---

Note: On a monitor wall display connected to a KMV-3901/3911 multiviewer output, there is no difference in the rendering between bold and regular text.

---

- 4 Click **OK**.

## Configuring Alarm Monitors

### To add an alarm monitor to a layout

- 1 Click the Alarm monitor button () on the toolbar, click the layout, and then move or resize the monitor as needed.

You may choose to layer this monitor on top of the video window within a composite. See [Working with Composite Monitors](#) on page 289, for instructions on how to add elements to a composite.

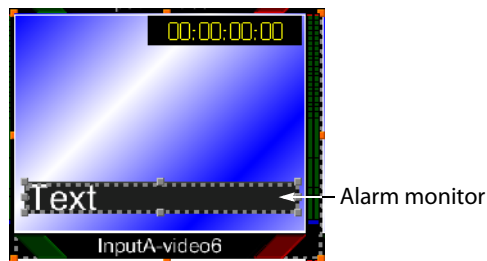

---

Note: On the monitor wall, an alarm monitor positioned over a video window has the following default behavior:

- If the source assigned to the alarm monitor is an active alarm (red), the alarm monitor is visible. The video transparency settings configured in XEdit for this alarm monitor apply to the part of the monitor that overlaps the video window.
  - If the source assigned to the alarm monitor is an inactive alarm (green), the alarm monitor is not visible on the monitor wall. If the alarm monitor partially overlaps the video window, then the part of the monitor that does not cover the video window remains visible (green).
- 

- 2 In the **Properties** pane, set the transparency attribute to the appropriate value for your purposes, by clicking the **Transparency** box, and then using the slider or typing the desired value directly into the box.

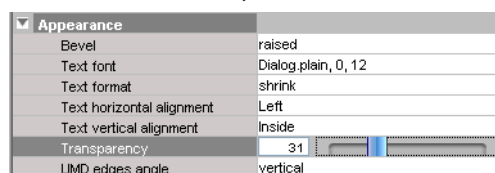

Set the other appearance attributes as desired.

- 3 In the **Alarms/Tallies** section, set the appropriate color and video transparency scheme for the text and background, to achieve the desired alarm reporting and source reporting behaviors (see [Configuring an Alarm Monitor's Source Reporting Behavior](#),

on page 275, for details).

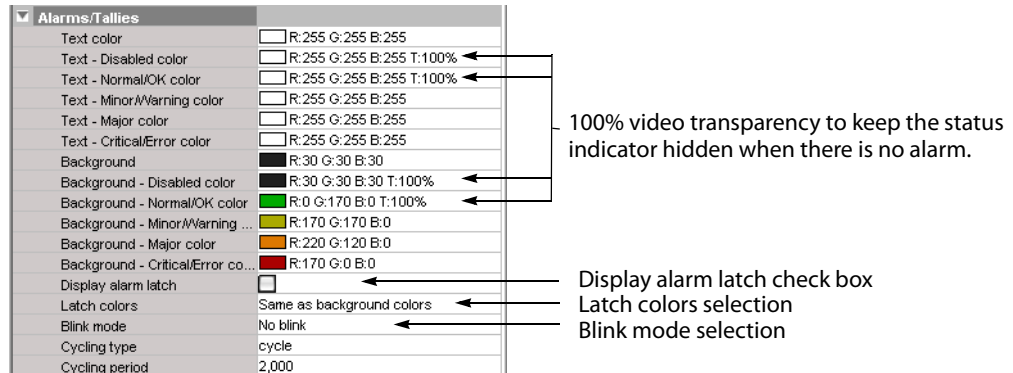

- 4 Click the **Blink mode** box, and then select the appropriate blinking behavior, for your purposes:

Blink mode	Description
<b>Off</b>	The status indicator will never blink.
<b>Follow latch</b>	The status indicator's blinking will follow the latch status. The indicator will blink until someone unlatches the alarm.
<b>Critical</b>	The status indicator will blink when the current status is critical.
<b>Critical and major</b>	The status indicator will blink when the current status is critical or major.
<b>Critical, major and minor</b>	The status indicator will blink when the current status is critical, major or minor.

- 5 To enable the latched status indicators, select the **Display alarm latch** check box, click the **Latch colors** box, and then select the appropriate color scheme for your purposes: either **Same as text colors**, or **Same as background colors**.
- 6 Choose from two display modes: **Cycle** and **Marquee**.  
In cycle mode, the alarm monitor displays text from each alarm, one after the other. In marquee mode, the alarm text scrolls across the monitor. In addition, you can control the cycling speed and the scroll rate by setting the cycling period, in milliseconds.
- 7 Make the appropriate assignments (see [Assigning Logical Sources or Monitor Wall Destinations to Monitors](#), on page 232), and select the desired alarm and text label levels, if necessary.

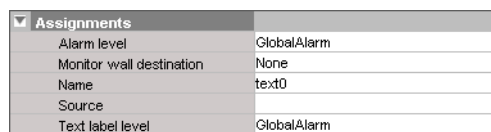

- 8 On the **File** menu, click **Save**.

### Configuring an Alarm Monitor's Source Reporting Behavior

To help you distinguish which sources are currently active on the monitor wall, monitors that are capable of displaying an alarm status (e.g. video monitors, subtitled monitors,

UMDs, alarm monitors) can have their borders, background or text configured to appear in a specific color, based on their current source. Alarm monitors can provide this information through their text and background colors.

### To configure an alarm monitor's background or text colors for source reporting

- 1 In XEdit, open a layout and click the alarm monitor whose source reporting behavior you wish to configure.

**Note:** Double-click the alarm monitor, if it is part of a composite monitor.

- 2 In the **Properties** pane, scroll down to the **Alarms/Tallies** section.

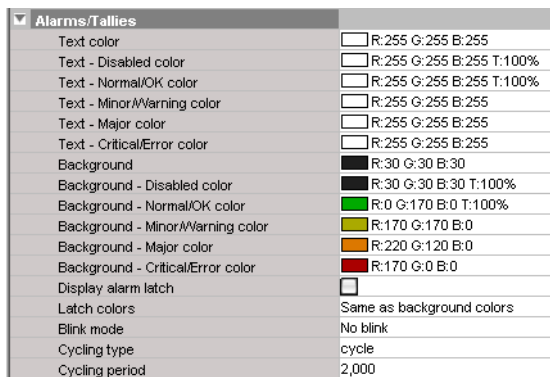

- 3 Click the text or background color box for a state you want associated with a distinctive color, based on the monitor's current source.
- 4 Click the button that appeared at the end of the box.

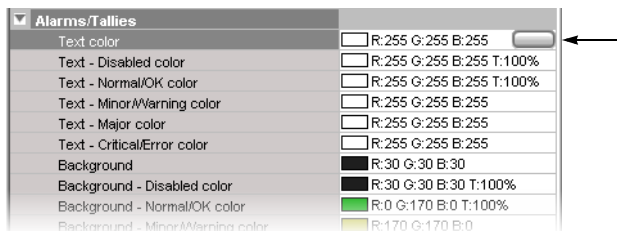

- 5 In **Colors**, select the appropriate level from the **Source color level** list. See [Configuring color level assignments](#) on page 188, for more information.



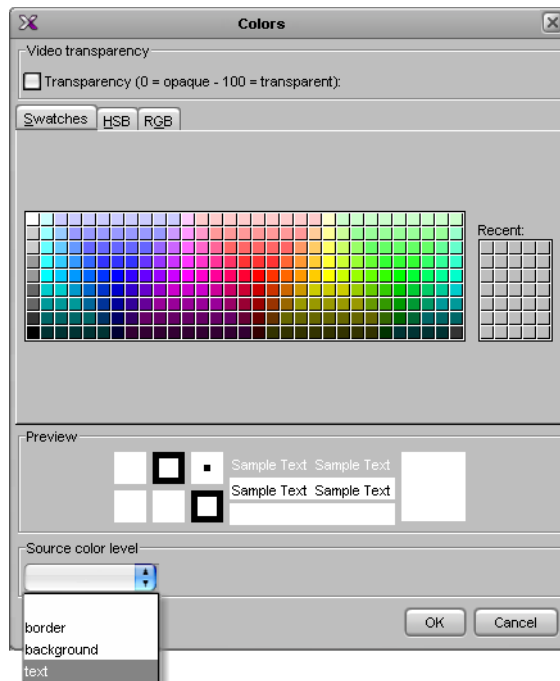

- 6 Set the color's transparency as desired.
- 7 Set the color to be used for sources whose color levels might not be defined, by clicking the tab that corresponds to the color space you wish to use, and then choosing the desired color.
- 8 Click **OK** to close the color picker window.

In the **Properties** pane, the name of the selected source-based color level appears next to the fallback color (and transparency, if used).

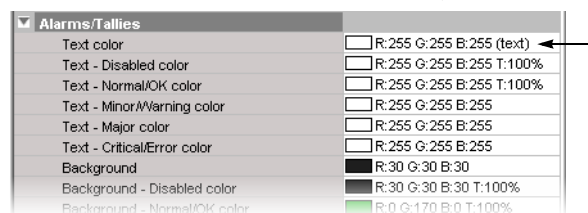

- 9 Repeat from [step 3](#) for the remaining colors you wish to set.

## Configuring Subtitling Monitors

### To monitor subtitling from a DVB or SCTE 27 stream

- 1 To add a subtitling monitor, click the Subtitling monitor button () on the toolbar, click the layout, and then move or resize the monitor as needed.
- 2 Click the subtitling monitor you wish to configure.

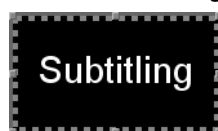

The subtitling monitor's attributes appear in the **Properties** pane.

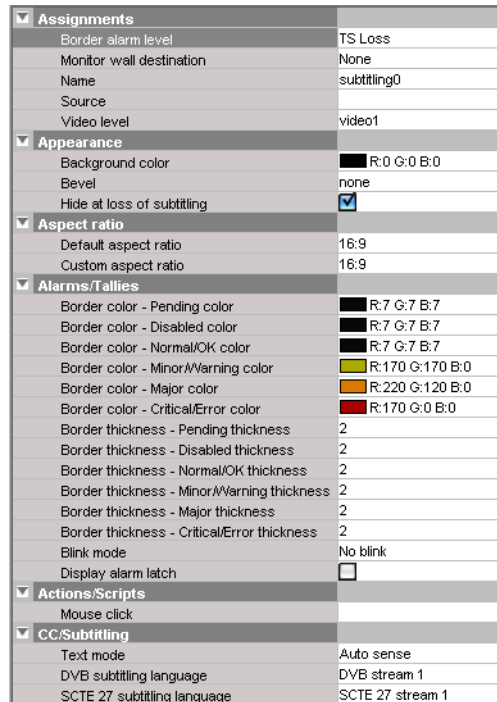

The first alarm level is selected by default for alarm reporting.

- If you wish to monitor a different alarm level, or the source's global alarm, select the appropriate level from the **Border alarm level** list.

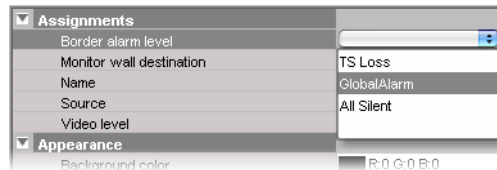

The first video level applies by default.

- If your system's logical sources include more than one video level, select the one you wish to monitor from the **Video level** list.

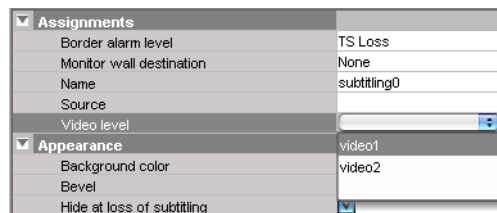

- If you wish to replace the default name, type a new name in the **Name** box.



- If you wish to assign a logical source, drag the appropriate element from the **Channels/Sources** list that appears in the **Tools** pane, to the subtitling monitor.

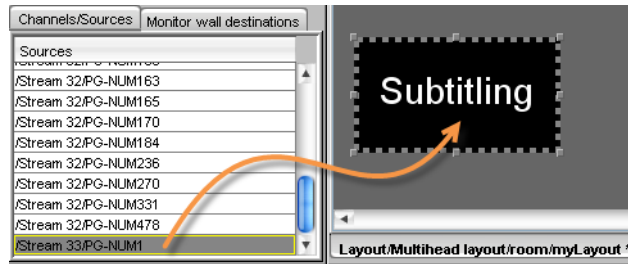

The selected logical source's name appears in the **Source** box.

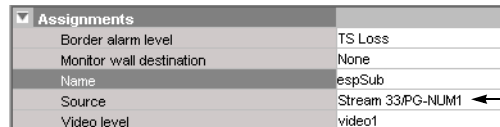

- If you wish to pre-select a specific text mode for this monitor, select the desired value from the **Text mode** list (see [Teletext](#), [Subtitles](#), and [Closed Captions](#), on page 156).

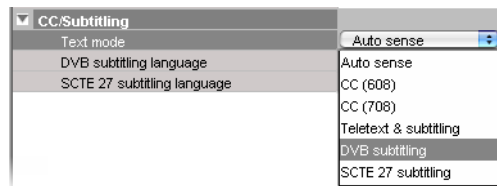

- If you wish to pre-select a specific DVB subtitling language for this monitor, click to expand the **DVB subtitling language** list and then select the appropriate language or DVB stream you wish to monitor.

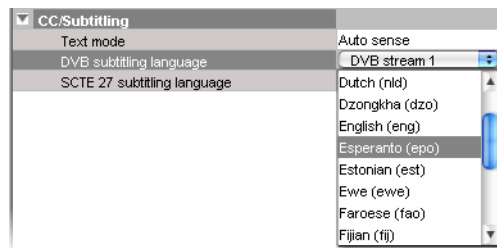

The list of subtitling streams and languages contains the following:

- A series of DVB streams identified by their relative number: **DVB stream 1** to **DVB stream 12**. Choose from this series if you wish to always monitor the third available subtitling stream, for example.
- A list of all supported languages, in alphabetical order based on the English name, which is followed with the corresponding ISO 639-2 alpha-3 code. Choose from this series if you wish to monitor subtitling in a specific language.

When XEdit is connected to the multiviewer, the available languages are indicated in bold text. The ISO 639-2 alpha-3 code for each available language, and the corresponding PID appear in the list of relative subtitling streams.

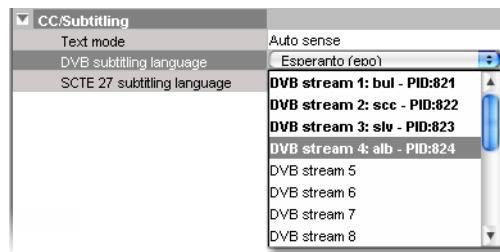

Then, following **DVB stream 12**, for each of the currently available languages, the name, the 3-letter code, and the corresponding PID appear in bold text before the list of all supported languages.



- 9 If you wish to pre-select a specific SCTE 27 subtitling language for this monitor, click to expand the **SCTE 27 subtitling language** list and then select the appropriate language or SCTE 27 stream you wish to monitor.



The list of subtitling streams and languages contains the following:

- A series of SCTE 27 streams identified by their relative number: **SCTE 27 stream 1** to **SCTE 27 stream 12**. Choose from this series if you wish to always monitor the third available subtitling stream, for example.
- A list of all supported languages, in alphabetical order based on the English name, which is followed with the corresponding ISO 639-2 alpha-3 code. Choose from this series if you wish to monitor subtitling in a specific language.

When XEdit is connected to the multiviewer, the available languages are indicated in bold text. The ISO 639-2 alpha-3 code for each available language, and the corresponding PID appear in the list of relative subtitling streams.

Then, following **SCTE 27 stream 12**, for each of the currently available languages, the name, the 3-letter code, and the corresponding PID appear in bold text before the list of all supported languages.

- 10 Modify the subtitling monitor's **Appearance** properties as needed.

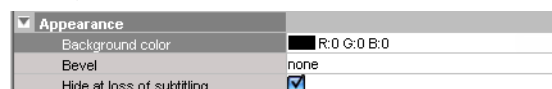

- 11 If you wish to use the subtitling monitor's background color for source reporting:
  - a Click the **Background color** box, and then click the button that appeared at the end of the box.

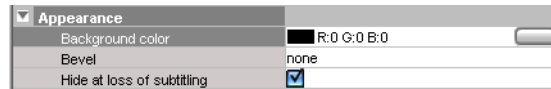

- b In **Colors**, select the appropriate level from the **Source color level** list. See [Configuring color level assignments](#) on page 188, for more information.

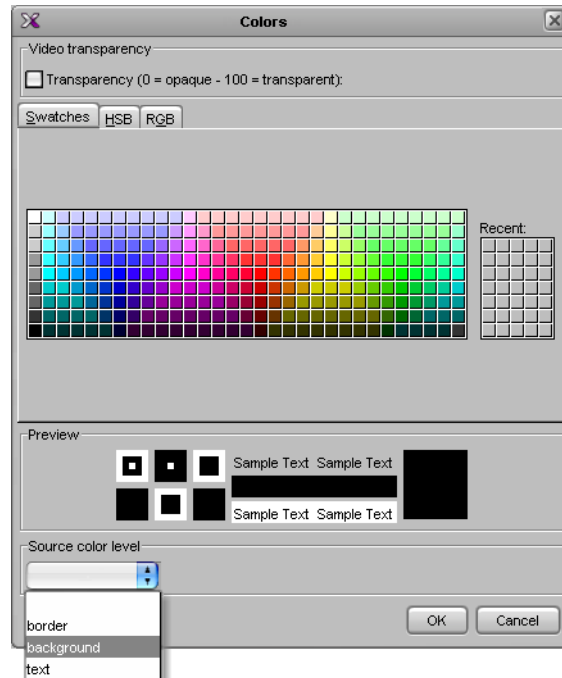

- c Set the color's transparency as desired.
  - d Set the color to be used for sources whose color levels might not be defined, by clicking the tab that corresponds to the color space you wish to use, and then choosing the desired color.
  - e Click **OK** to close the color picker window.
  - f In the **Properties** pane, the name of the selected source-based color level appears next to the fallback color (and transparency, if used).

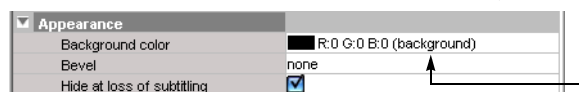

- 12 Change the **Default aspect ratio** as needed.

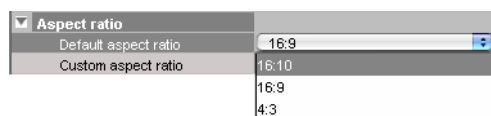

This value is used in the absence of aspect ratio information in the DVB or SCTE 27 subtitling stream, when the associated video stream is not decoded. When the video is decoded, the video signal's aspect ratio is used, in the absence of aspect ratio information in the subtitling stream. See [Setting a Video Monitor's Aspect Ratio](#) on

page 238 for more information, including on selecting a custom aspect ratio.

- 13 Refer to [Configuring a Video Monitor's Alarm Reporting Behavior](#), on page 245, and to [Configuring a Video Monitor's Source Reporting Behavior](#), on page 246, to configure the subtitling monitor's other alarm reporting, and source reporting features.

Alarms/Tallies	
Border color - Pending color	■ R:7 G:7 B:7
Border color - Disabled color	■ R:7 G:7 B:7
Border color - Normal/OK color	■ R:7 G:7 B:7
Border color - Minor/Warning color	■ R:170 G:170 B:0
Border color - Major color	■ R:220 G:120 B:0
Border color - Critical/Error color	■ R:170 G:0 B:0
Border thickness - Pending thickness	2
Border thickness - Disabled thickness	2
Border thickness - Normal/OK thickness	2
Border thickness - Minor/Warning thickness	2
Border thickness - Major thickness	2
Border thickness - Critical/Error thickness	2
Blink mode	No blink
Display alarm latch	<input type="checkbox"/>

- 14 Refer to [Creating Monitor Wall Actions](#), on page 303 to configure mouse-click actions for this subtitling monitor.



- 15 On the **File** menu, click **Save**.

## Configuring Metadata Monitors

### To monitor XDS data, or digital content advisory descriptor (CAD) information

- 1 Click the Metadata monitor button () on the toolbar, click the layout, and then move or resize the monitor as needed.

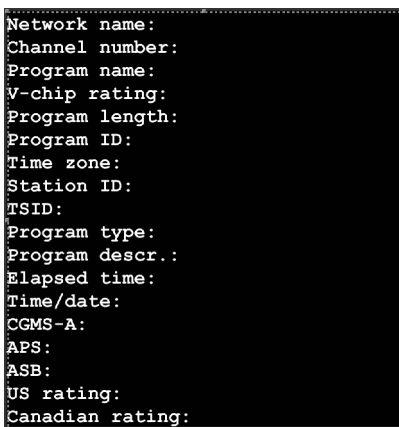

Alternatively, you may choose to layer this monitor on top of the video window within a composite. See [Working with Composite Monitors](#) on page 289, for instructions on how to add elements to a composite.

- 2 In the **Properties** pane, select the check boxes that correspond to the data elements you wish the monitor to display.
  - XDS data: APS, ASB, CGMS-A; channel number; elapsed time; network name; program description, ID, name, length, and type; station ID; TSID; time/date; time zone; V-chip rating
  - CAD information: US rating, Canadian rating

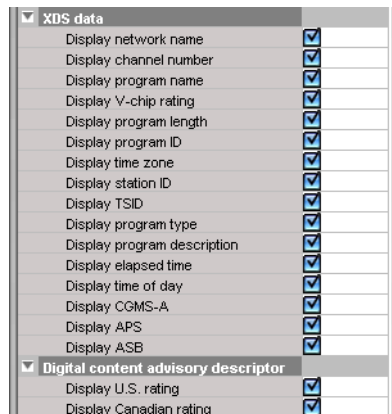

- 3 You can also set appearance properties, including the font and size of the text labels, or choose not to display the labels by clearing the **Display legend** check box.

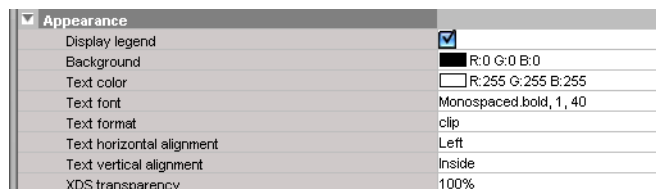

The selected monitor is updated accordingly on the layout.

- 4 Make the appropriate assignments (see [Assigning Logical Sources or Monitor Wall Destinations to Monitors](#), on page 232) and select the desired video level, if necessary.

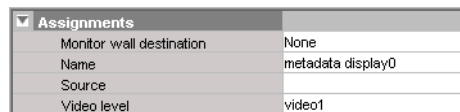

- 5 Click the Save button on the toolbar.

## Configuring V-Chip Monitors

A V-chip monitor provides a visual indication of the V-chip rating from the CC (608) metadata in an SD video signal, or from the CC (608) legacy caption data when such data is present within an HD video signal.

---

**Note:** Extraction of CC (608) captions and CC (608) legacy captions is available with the *Extraction of CC, Subtitling and XDS metadata* option (CC/XDS).

---

### To add a V-chip monitor to a layout

- 1 Click the V-chip monitor button () on the toolbar, click the layout, and then move or resize the monitor as needed.

You may choose to layer this monitor on top of the video window within a composite. See [Working with Composite Monitors](#) on page 289, for instructions on how to add elements to a composite.

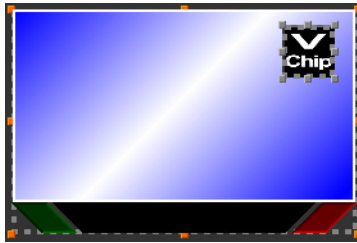

- 2 In the **Properties** pane, set the transparency attribute to the appropriate value for your purposes, by clicking the V-chip transparency box, and then using the slider or typing the desired value directly into the box.



- 3 If you wish to preview the logo associated with a specific V-chip rating, select it from the **V-chip rating preview** list. For example:

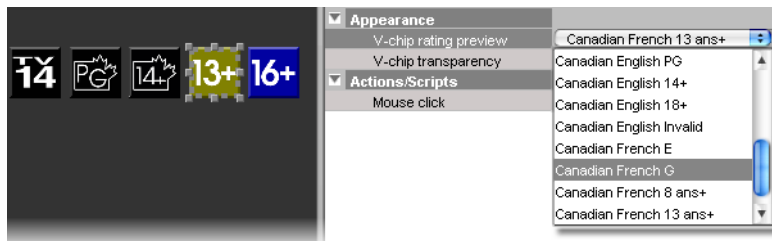

---

**Note:** As its name implies, the V-chip rating preview is only a preview, and its value is not saved with the layout.

---

- 4 Make the appropriate assignments (see [Assigning Logical Sources or Monitor Wall Destinations to Monitors](#), on page 232), and select the desired video level if necessary.

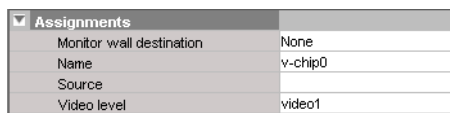

- 5 On the **File** menu, click **Save**.

---

### Notes

- Unlike alarms, the V-chip rating associated with a video signal that is currently monitored on the monitor wall is not relayed to the XEdit user interface, when working in online mode.
  - The V-chip monitor uses the holding time configured with the **XDS filtering** calibrations for the associated video source (see [Calibrating Metadata Holding Time](#), on page 145). Once the specified holding time has expired, the V-chip monitor displays the N/A logo ( **N/A** ).
  - When V-chip data cannot be extracted from the current video signal, the V-chip monitor displays the N/A logo ( **N/A** ).
-



## Configuring Clocks

In addition to the default combo-type clock that can be added to a layout by using the Clock button (🕒) on the toolbar, the predefined widget library includes a selection of analog and digital clocks.

### Notes

- The KMV-3901/3911 and Kaleido-XQUAD do not support analog clocks.
- In the case of a KMV-3901/3911, Kaleido-XQUAD, Kaleido-MX or Kaleido-Modular-X, the system time is always based on UTC. However, if you wish to see the time from different time zones on the monitor wall, you can configure different clocks accordingly.

### To configure a clock

- 1 In the **Layouts** tab, click the clock you wish to configure.

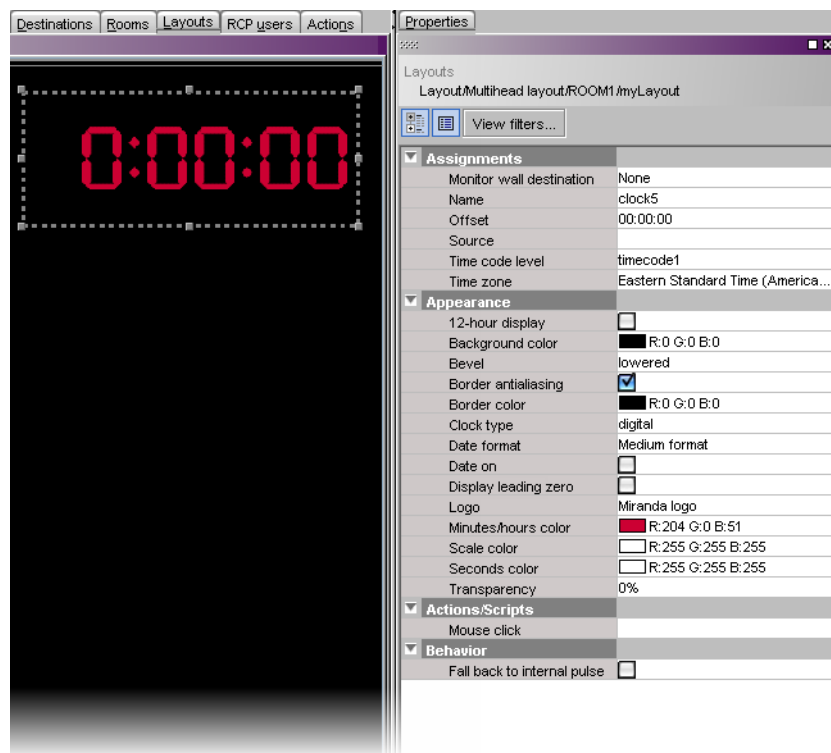

- 2 In the **Properties** pane, make the appropriate assignments:

- Determine the time source (see [Assigning Logical Sources or Monitor Wall Destinations to Monitors](#), on page 232), and select the desired time code level if necessary.

Assignments	
Monitor wall destination	None
Name	clock5
Offset	00:00:00
Source	Input A/Channel 01
Time code level	timecode1
Time zone	Eastern Standard Time (America...)

- Select the appropriate time zone for your purposes.

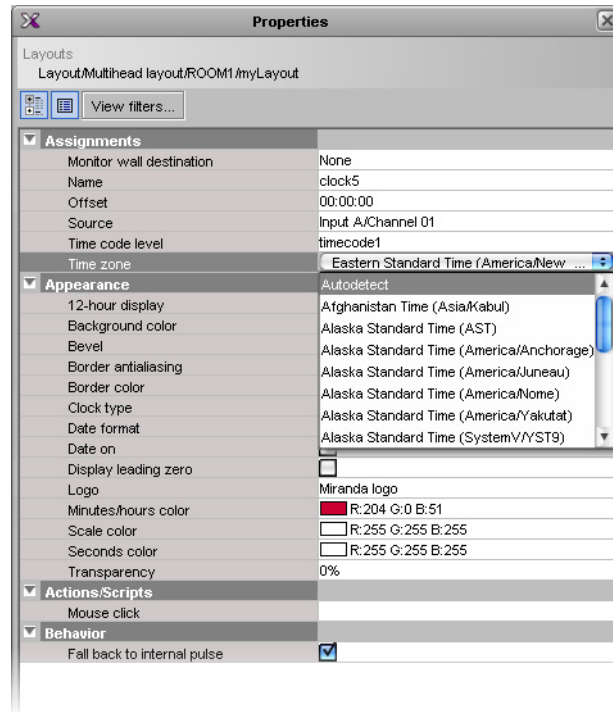

If you select **Autodetect**, then the clock will use the time zone from the assigned source, based on the following rules:

- If the clock is bound to an LTC or DVITC time code that includes time zone information, then the time zone is decoded from the time code.
  - If the clock is bound to the system time, or to an LTC or DVITC time code that *does not* include time zone information, then:
    - in the case of a Kaleido-X or Kaleido-X16 multiviewer model, the time zone configured in XAdmin applies;
    - in the case of a KMV-3901/3911 or Kaleido-MX, the system time is always based on UTC.
- 3 If the clock is bound to an LTC or DVITC time code, and you wish it to momentarily use the multiviewer's internal clock for reference should the assigned time code become unavailable, then select **Fall back to internal pulse**.



When a clock configured with this option loses its time reference, it will not stop but keep working to the beat of the multiviewer internal clock instead.

### Notes

- When a clock switches between the LTC or DVITC signal and the multiviewer's internal clock reference, you may notice a one-second offset on the monitor wall.

Notes (continued)

- Refreshing the current layout (or switching to another layout and then back) cancels the fallback mechanism. When this happens, the clock that had lost its time reference halts, showing the time it was at the moment the layout was refreshed (or loaded again), based on the multiviewer system clock.

4 Modify the clock's **Appearance** properties as needed:

- From the **Clock type** list, select between a digital, an analog or a combo-type clock.



- Resize the clock as needed, set color attributes and select the appropriate date and time formats.
- In the case of a digital or combo-type clock, select the **Display leading zero** check box, if you wish to see the time with a leading zero when it is before 10:00 a.m. or 10:00 p.m.

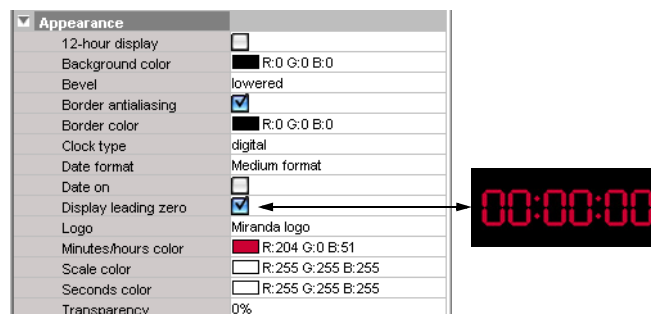

- In the case of an analog or combo-type clock, you can also add a clock logo (see [Inserting a Clock Logo](#), below).
- In the case of an analog or combo clock, if the clock is to be displayed against a pink background— RGB (255, 0, 255) or similar—, or if the current layout belongs to a cascade room (see [page 71](#)), then make sure to clear the **Border antialiasing** check box.

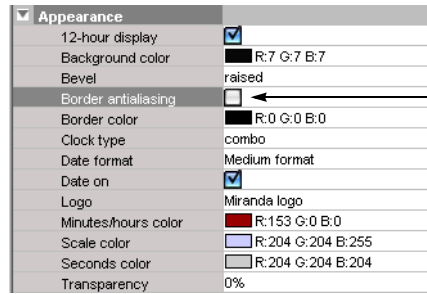

In such cases, if border antialiasing remains enabled, the clock will have a pink outline on the monitor wall.

- 5 Define actions associated to this layout element (see [Creating Monitor Wall Actions](#), on page 303).
- 6 On the **File** menu, click **Save**.

## Inserting a Clock Logo

---

### Notes

- The maximum **size** for each image is 256 KB, and the maximum overall size (for all images) is 10 MB. The image can be in PNG, GIF, or JPEG format. Images can be used on multiple layouts and only need to be imported to the database once.
  - In the case of a **cascade** system, XEdit must be connected to the multiviewer that will provide the source for the corresponding clock. A clock that is not associated with a specific source is displayed by the system closest to the display.
- 

### To insert a clock logo

- 1 In the **Properties** pane, click the **Logo** box, under **Appearance**.
- 2 Click the button that appeared at the end of the box.

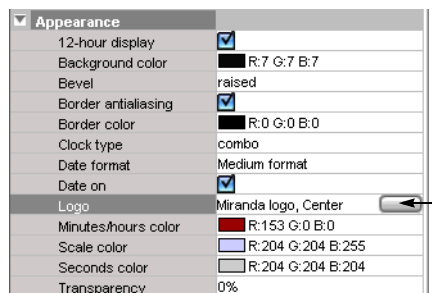

The **Select Image** window appears.

- 3 If the logo you wish to use is not already listed in **Select Image**, then click the **Open**  button to open the **Browse Image** window. Locate the image, select it, and then click **Open**.

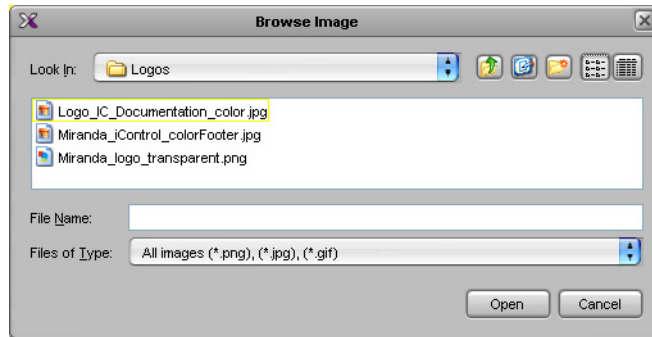

The image is imported into the database.

- 4 In **Select image**, select the logo you wish to use from the **Image selection** list, and then click **OK**.



The logo appears on the clock background.

## Working with Composite Monitors

### Creating a Composite Monitor

Composite monitors encapsulate a number of primary elements (e.g. a video monitor, one or two audio monitors, a UMD, and a time code) that can then be managed as a single object. The following example outlines the basic rules to follow, in order to create composite monitors that can be resized elegantly.

#### To create a composite monitor

- 1 Open an existing layout or create a new one.
- 2 Click the Composite button  on the toolbar, and then click the layout. Resize the empty composite box approximately, to a size that will be appropriate for the display where it is to appear.



*Empty composite*

- 3 Right-click the empty box, and then click **Unlock** on the menu.  
Notice that the handles around the box boundary line become orange.



*Unlocked empty composite*

---

**Note:** If you double-click a composite monitor, the handles also become orange. However, in such a case, you cannot move or resize individual components within the composite (see [Unlocking a Composite Monitor](#), on page 295).

---

- 4 Add a monitor to the composite, either using a button on the toolbar or dragging an element from a widget library. For example, click the Video monitor button  on the toolbar, and then click inside the composite to add a video monitor.



*Video monitor within unlocked composite*

---

**Note:** Only primary monitors (not composite) can be part of a composite.

---

- 5 Click the Audio monitor button  on the toolbar, and then click inside the composite to add an audio level meter.

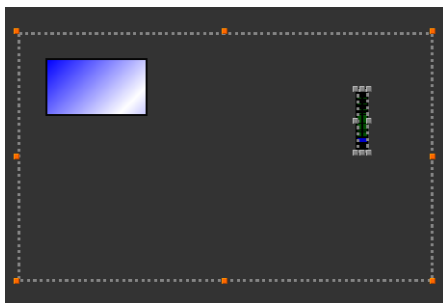

*Audio level meter within unlocked composite*

- 6 Click the UMD button  on the toolbar, and then click inside the composite to add a UMD.

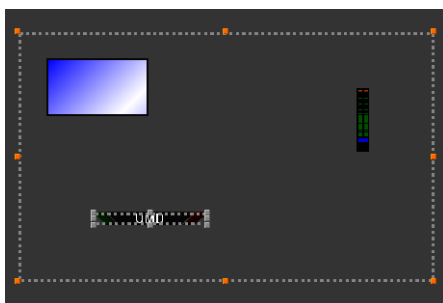

*UMD within unlocked composite*

- 7 Move the audio level meter *to the very edge* of the composite, using the mouse and then finishing with the arrow keys, and resize it as appropriate.

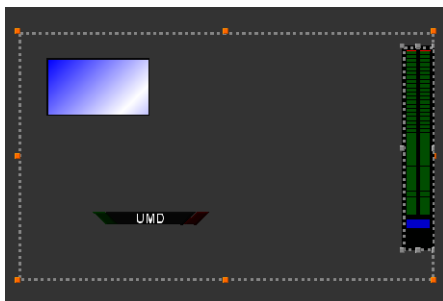

*Audio level meter resized and moved to the side*

- 8 Move the UMD *to the very bottom* of the composite, using the mouse and then finishing with the arrow keys, and resize it if needed.

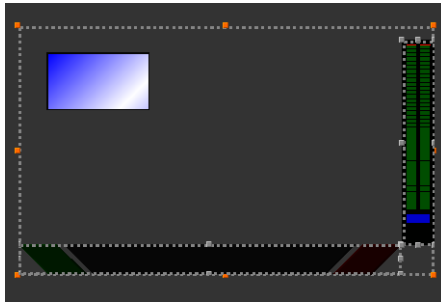

*UMD resized and moved to the bottom, with its upper right handle matching the audio level meter's lower left handle*

---

### Notes

- Making sure that UMDs and audio monitors do not overlap one another in a composite monitor will ensure optimal performance of any layout where several copies of this composite might appear. As a rule, avoid overlapping graphical elements in a layout.
- To align a monitor more precisely against another, select one of them, and then click the second one while holding the Shift key. It is then possible to drag any of the sizing handles (the larger grey dots) to resize any of the selected monitors, while their relative position remains visible. Whenever appropriate, matching adjacent monitors' corner or center handles together will help achieve a composite that can be resized elegantly.

- 
- 9 Move the video monitor to the top-left corner of the composite, then click its bottom-right corner handle, and drag it to stretch the video until one of its dimensions completely fills the empty area (vertically or horizontally).

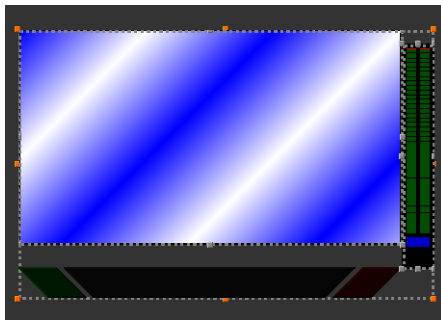

*Video monitor stretched to fill the remaining horizontal area*

- 10 Drag the video monitor's bottom-center handle until it meets the UMD's bounds.



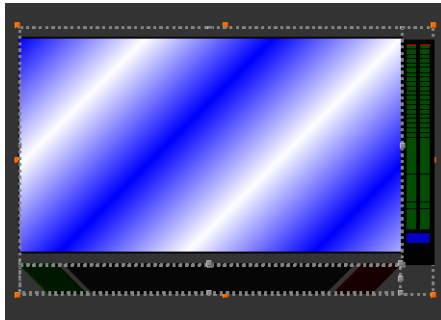

*Video monitor stretched vertically with its bounds matching the UMD's*

---

**Note:** Resizing the video monitor is easier with the UMD's bounds visible: first click the video monitor and then click the UMD while holding the Shift key.

---

- 11 Adjust the size and position of the components some more if needed, making sure to keep the peripheral monitors at the very edges of the composite's boundary box, while minimizing empty space within the composite.
- 12 Click outside the composite to lock it.

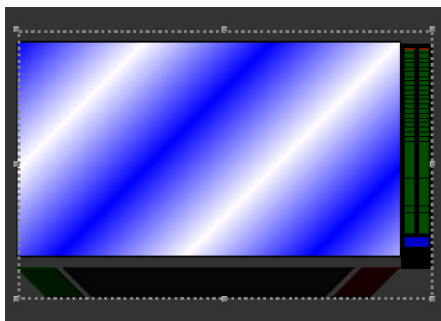

*Locked composite*

- 13 Drag the composite's top or bottom center handle inwards, until there is no more empty space above and below the video monitor.

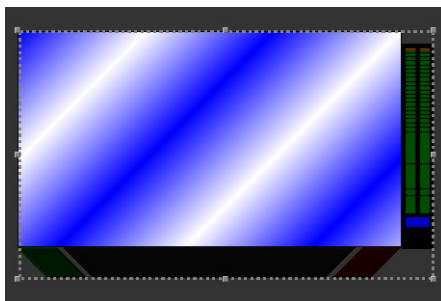

*Composite resized to remove remaining empty space around video monitor*

- 14 To be able to reuse the new composite in other layouts, drag it onto the appropriate widget library while *holding the Ctrl key*. See [Creating a Widget Library](#) on page 298 for more information.
- 15 On the **File** menu, click **Save**.

## Resizing a Composite Monitor

### To resize a composite

- Click the composite monitor, and drag any of its *corner* handles outwards or inwards. The composite expands or shrinks while its individual elements maintain their relative position and aspect ratio.

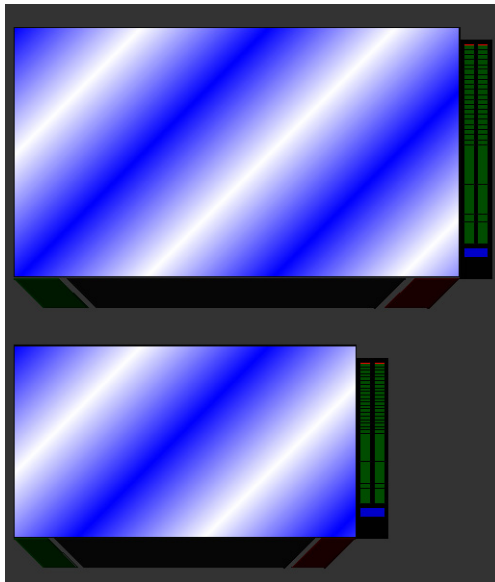

*Larger and smaller copies of the original composite*

---

**Note:** In the case of a Kaleido-X or Kaleido-X16, the minimum *width* supported for a video window is 1/16<sup>th</sup> of the original signal resolution. In the case of a Kaleido-X, the minimum *height* supported for a video window is 91 pixels. For a Kaleido-MX or Kaleido-Modular-X, the minimum width is 128 pixels. In the case of a KMV-3901/3911 or Kaleido-IP, there is no minimum size.

---

### Composite monitors configured for maximum video area

In the case of composite monitors from the legacy *maximum video area* widget libraries, or that were created with a version of XEdit earlier than 7.40, individual monitors within a composite are resized according to the following rules:

- Video monitors are scaled proportionally, in both width and height.
- Vertical audio monitors are scaled vertically, but their width does not change.
- Horizontal audio monitors, time codes, timers, and UMDs are scaled horizontally, but their height does not change.
- Clocks are not resized.

The following table summarizes these rules:

Monitor type	Height	Width
Video	Scalable	Scalable
Vertical audio monitor	Scalable	Fixed
Horizontal audio monitor, UMD, time code, timer	Fixed	Scalable
Clock	Fixed	Fixed

### Unlocking a Composite Monitor

Since a composite monitor functions as a single entity, its individual components are locked together. If you wish to configure individual components within a composite monitor, you need to first unlock the monitor. There are two ways in which a composite monitor can be unlocked, one of which prevents you from moving or resizing individual components. An unlocked composite monitor has orange handles around its boundary line.

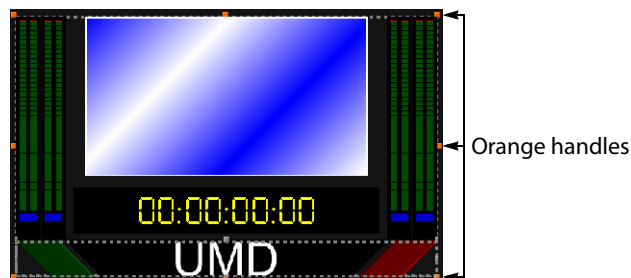

#### If you wish to configure properties for individual components within a composite monitor

- Double-click the composite monitor whose primary elements you wish to configure. Notice that the handles around the boundary line become orange. When using this method, you cannot move or resize the monitor's individual components.

#### If you wish to add, move, or resize individual components within a composite monitor

- Right-click the composite monitor you wish to modify, and then click **Unlock** on the menu. Alternatively, click the monitor, and then press F2. Notice that the handles around the boundary line become orange.

## Using the Region Editor

### Opening the Region Editor

---

**Note:** The region editor is part of the expert view. To show the expert view, click the **View filters** button on the **Properties** pane's toolbar, and then select the **Expert view** check box. Using the region editor is not recommended. To accomplish most configurations, the standard tools available in the layout editor are sufficient.

---

### To open the region editor

- 1 Click the monitor whose properties you wish to see.
- 2 In the **Properties** pane, click the **Bounds** box, under **Size & Position**.

Click the button that appeared inside the box to open the **Region Editor** window.

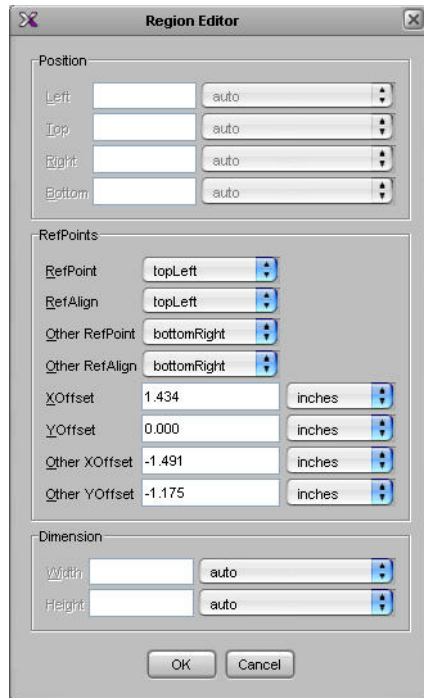

### Configuring a Monitor's Position Using the Region Editor

#### To set a monitor's position on the layout

- 1 For each position, first select the appropriate unit.

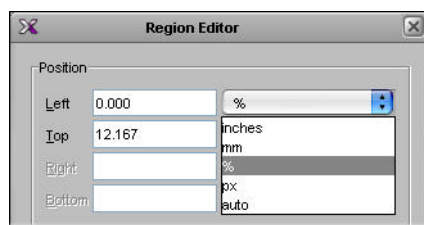

- 2 Type values in the **Left**, **Top**, **Right**, and **Bottom** boxes, relative to the upper-left corner of the display.
- 3 Click **OK** to close the editor.
- 4 On the **File** menu, click **Save**.

### Configuring a Monitor's Dimensions Using the Region Editor

#### To configure a monitor's dimensions

- 1 For each dimension, first select the appropriate unit.

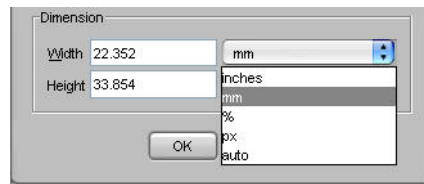

- 2 Type values in the **Width** and **Height** boxes.
- 3 Click **OK** to close the editor.
- 4 On the **File** menu, click **Save**.

## Format Painting

### Copying Properties from one Monitor to Another



Every monitor in a layout has properties related to its appearance that can be configured by the user, in the Properties pane. The Copy properties tool  copies most of these properties from one monitor *to another of the same type* (e.g. audio monitor to audio monitor, clock to clock, etc.).

---

**Note:** The **Copy properties** tool does not copy the assignments from one monitor to another, and it does not copy the size from one monitor to another.

---

#### To use the Copy properties tool

- 1 In the **Layouts** tab, click the monitor whose properties you wish to copy to another monitor of the same type.  
The monitor's boundary box appears.  
The Copy properties button  becomes available on the toolbar.
- 2 Click the Copy Properties button to switch into format-painting mode.
- 3 Point to another monitor of the same kind in the layout.  
The pointer changes to a pointing finger , indicating that the properties of the first monitor (whose boundary box is still shown) can be copied onto the monitor beneath the pointer.
- 4 Click the monitor beneath the pointer to copy the properties onto that monitor.  
Its appearance will change to reflect the new properties.

---

**Note:** To have the width and height copied as well, press and hold the Ctrl key while clicking the monitor.

---

- 5 Repeat this for each monitor whose properties you wish to change.
- 6 Click the Select button  on the toolbar to exit format-painting mode when you have finished.

## Copying Size from one Monitor to Another



The size of every monitor in a layout can be adjusted by the user, by dragging handles on the boundary box that appears when the monitor is selected. The Copy size tool  copies the size from one monitor *to another monitor of the same kind*.

---

**Note:** The **Copy size** tool does not copy any other property from one monitor to another.

---

### To use the Copy size tool

- 1 In the **Layouts** tab, click the monitor whose size you wish to copy to another monitor of the same type.  
The monitor's boundary box appears.  
The Copy size button  becomes available on the toolbar.
- 2 Click the **Copy size** button to switch into size-painting mode.
- 3 Point to another monitor of the same kind in the layout.  
The pointer changes to a pointing finger , indicating that the size of the first monitor (whose boundary box is still shown) can be copied onto the monitor beneath the pointer.
- 4 Click the monitor beneath the pointer to copy the size onto that monitor.  
Its size will change to match that of the first monitor.
- 5 Repeat this for each monitor whose size you wish to change.
- 6 Click the Select button  on the toolbar to exit size-painting mode when you have finished.

## Managing Widget Libraries

### Creating a Widget Library

#### To create a widget library

- 1 Click the **Layouts** tab.
- 2 Right-click inside one of the predefined widget libraries in the **Tools** pane, and then click **New widget library** on the menu. Alternatively, click **New widget library** on the **File** menu.

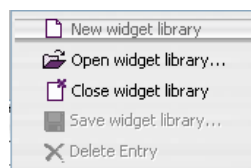

*Widget-library menu.*

The new widget library appears below the default widget library area in the **Tools** pane.

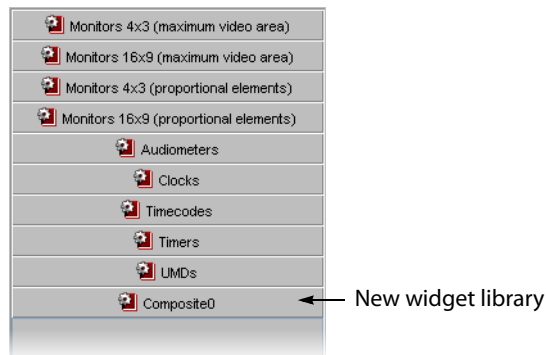

- 3 On the **File** menu, click **New**. Alternatively, click **Open** to open an existing layout.
- 4 Click the appropriate button on the toolbar, then click the layout to add a monitor of the selected type. Alternatively drag a monitor from one of the existing libraries onto the layout, or choose an existing monitor within the layout.
- 5 Customize the monitor if necessary, and then drag it onto the new widget library while *holding the Ctrl key*.

**Note:** It is not possible to customize a monitor once it is inside a library.

- 6 Right-click anywhere inside the widget library, and then click **Save widget library** on the menu.

The **Save Widget Library** window appears.

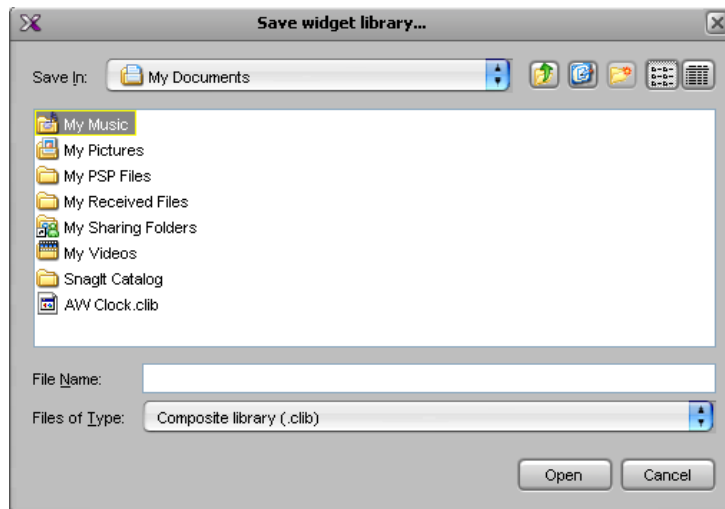

- 7 Type a name for the new custom widget library, and then click **Save**.

## Closing a Widget Library

### To close a widget library

- Once the custom library is saved, you can right-click in the library area, and then click **Close widget library** on the menu. Alternatively, on the **File** menu, click **Close widget library**.

## Opening a Widget Library

### To open a custom library

- Right-click inside one of the predefined widget libraries in the **Tools** pane, and then click **Open widget library** on the menu.
- On the **File** menu, click **Open widget library**.
- On the **File** menu, point to **Open recent**, and then select from the list of recently used widget libraries.

---

**Note:** It is possible to have multiple custom libraries open at the same time.

---



# 10

## Creating Actions

This chapter describes how to configure and trigger monitor wall actions, and background actions.

### Overview

An action is an operation automatically performed in response to a specific trigger. A *monitor wall action* is associated with a monitor belonging to a specific layout or directly with a specific layout. It can only be activated when that layout is loaded on the monitor wall, whereas a *background action* can be triggered at any time by any alarm on the multiviewer. Unlike monitor wall actions, background actions are always available within a Kaleido-X system, regardless of what layouts are currently loaded. Examples of actions:

- Unlatch/Acknowledge all
- Load layout
- Assign logical source (channel)
- Set GPI output
- Show/Hide full screen layout
- Reset/Pause/Start a timer
- Monitor audio
- Toggle destination overlay
- Switch router crosspoint
- Custom (JavaScript)

---

**Note:** Version 5.30 of the Kaleido-X software introduced a bug fix that required changes to the JavaScript code associated with all predefined actions elements in XEdit. For the fix to be applied to actions created with an earlier version of XEdit, open them with version 5.30 or later, and view the underlying JavaScript code by selecting every action element in turn, and then clicking the **View source** button in the **Properties** pane. XEdit will automatically update the JavaScript code. Verify that the first lines in the code start with `var param_<xxx> = <value>`, before saving the action.

---

### Key Concepts

Term	Description
Layout	A group of monitors (or composite monitors) arranged for display on a monitor wall.
XAdmin	The application used to perform administrative functions (e.g. configure network settings) on a Kaleido-X monitoring system.

Term	Description
XEdit	The application used to create and modify rooms, layouts and other components of a Kaleido-X monitoring system.
Composite monitor	A group of primary monitors.
Monitor	A graphical component used in the creation of a layout. Typical monitors include UMDs, time code monitors, audio monitors, video monitors, and clocks.
Action item	Action elements that are associated with a specific action (e.g. Load Layout, Set GPI Out, etc.).
System list	Refers to the hierarchical list visible under XEdit's System tab, which gives a virtual representation of the system hardware (i.e. multiviewers and peripheral devices).
Trigger	<p>Refers to the event that causes an action to be invoked. For a monitor wall action, a trigger could be a double click on a monitor. Background actions are triggered by alarms or by a Gateway command. When defining an action for a monitor, you could specify, for instance, that a specific full screen layout be displayed on the monitor wall in response to the trigger.</p> <p><b>On Change:</b> background action is triggered by any change in alarms status</p> <p><b>On Disabled:</b> background action is triggered when an alarm is disabled</p> <p><b>On Normal/OK:</b> background action is triggered when an alarm reverts to normal</p> <p><b>On Minor/Warning:</b> <i>supported for Gateway alarms only</i></p> <p><b>On Major:</b> <i>supported for Gateway alarms only</i></p> <p><b>On Critical/Error:</b> background action is triggered by a critical alarm</p>
Triggering of actions	<p>Any multiviewer alarm can be used as a trigger to invoke a background action.</p> <p><b>Note:</b> A background action triggered by an alarm is always executed, regardless of the alarm's operational mode (see <a href="#">Alarm Suppression</a>, on page 154).</p> <p>The end event of any countdown timer can be used as a trigger to invoke a background action.</p> <p>Gateway commands sent by an external device can be used to trigger actions created in XEdit.</p> <p>Any GPI input from the multiviewer can trigger a background action.</p>
Triggering of GPI outputs	Any multiviewer alarm can be used to trigger a GPI output change.
Gateway	Refers to the "Kaleido Remote Control Protocol (Gateway)" interface supported by Kaleido multiviewers. See the <i>Kaleido Remote Control Protocol (Gateway) User's Guide</i> for more information.

## Detailed Directions

### Creating Monitor Wall Actions

Monitor wall actions can be assigned to a monitor on a specific layout. Such actions can only be triggered when that layout is loaded on the monitor wall.

#### To assign a monitor wall action to a monitor

- 1 Open the layout that contains the monitor to which you wish to assign an action, or create a new layout.
- 2 In the **Layouts** tab, unlock the appropriate composite monitor if applicable (see [Unlocking a Composite Monitor](#), on page 295), and then click the monitor you wish to configure.
- 3 In the **Properties** pane, click the **Mouse click** box, under **Actions/Scripts**.



**Note:** For a UMD, three action types can be set, and there is a box for each under **Actions/Scripts: Left tally - Mouse click, Right tally - Mouse click, and UMD click.**

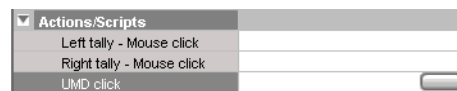

- 4 Click the button that appeared at the end of the box you clicked.  
The **Action Editor** window appears.
- 5 In **Action Editor**, drag the appropriate action item from the **Action List** pane to the middle pane under either the **Single Click** or **Double Click** tab.

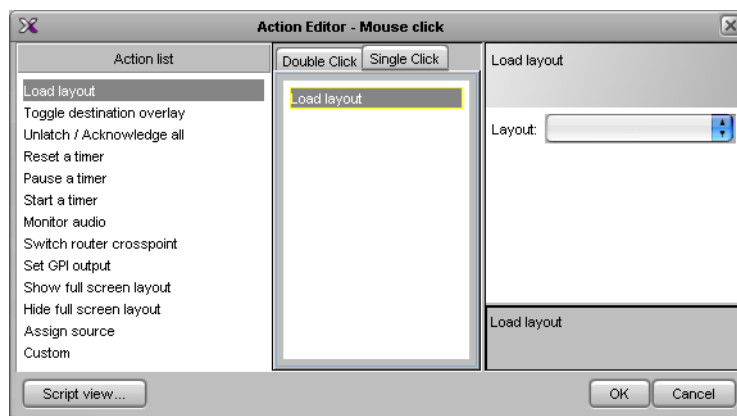

- 6 Select the action in the middle pane.
- 7 In the right pane, specify the attributes of the action.
- 8 Repeat the procedure if you wish to add action items. If multiple actions are specified, the trigger (e.g. single click on UMD) will cause all of these actions to be executed in order.

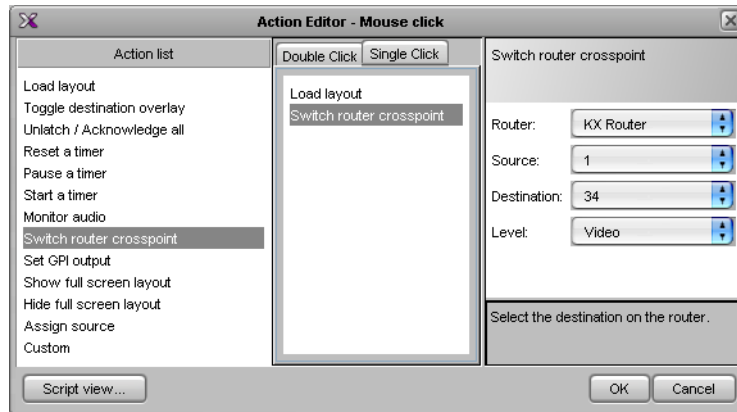

- 9 When finished, click **OK** to close the window, and then click the Save button on the toolbar.

The next time the layout is loaded on the monitor wall, the actions will be available.

---

**Note:** When you click a monitor on the monitor wall, all the actions associated with the single-click event are triggered. When you double-click a monitor, all the actions associated with the single-click AND the double-click events are triggered.

---

## Creating Background Actions

### Creating a Background Action from the Actions Tab

#### To create a background action

- 1 Open XEdit and load the database associated with the multiviewer for which you wish to create a background action. Alternatively, click **Connect** on the **Configure** menu, to work online (see [Using XEdit Online](#), on page 75).
- 2 Click the **Actions** tab.

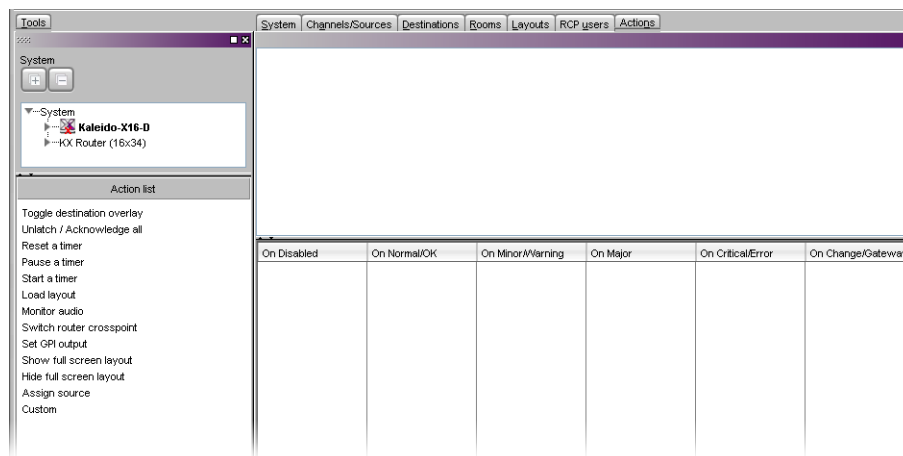

- 3 Click the New button on the toolbar.

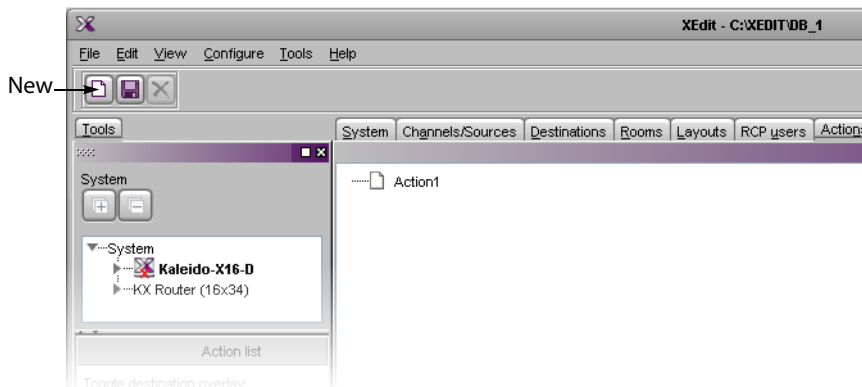

- 4 In the **Tools** pane, click and drag an alarm from the filtered System list onto the new action. This defines the alarm as the trigger for the action.

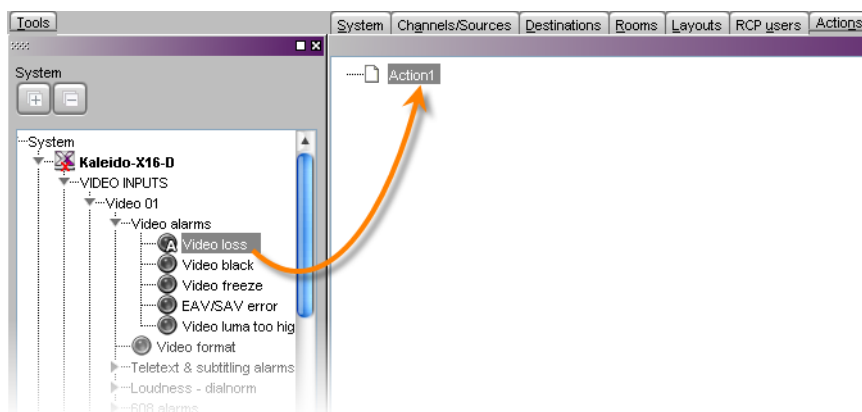

---

**Note:** You do not have to perform this step for actions triggered by Gateway commands, because the Gateway alarm itself acts as the trigger. See [Creating an Action that can be Triggered via a Gateway Command](#), on page 307.

---

- 5 From the **Action list** area of the **Tools** pane, drag one of the available action items onto one of the six columns at the bottom of the **Actions** tab.

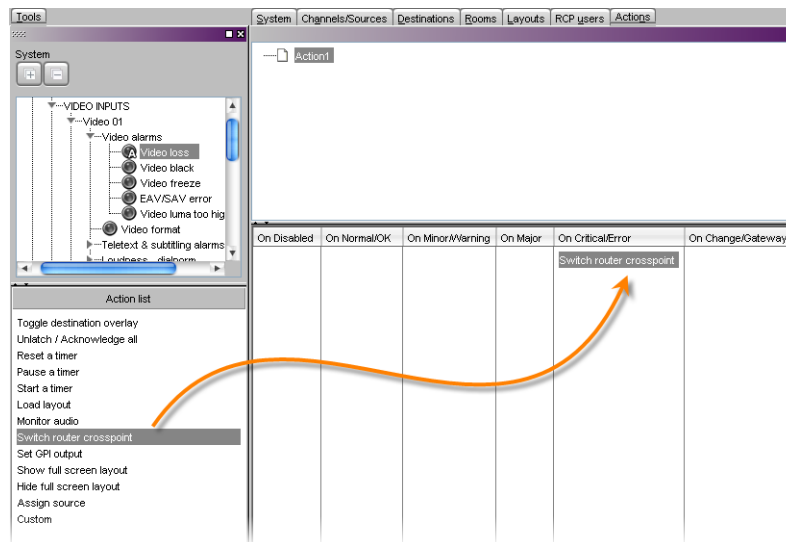

6 Configure the action's properties in the **Properties** pane.

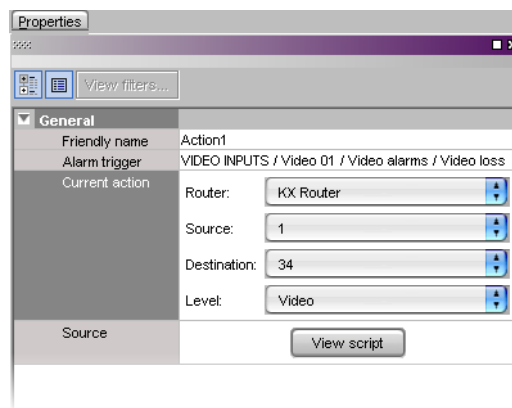

7 Repeat [step 5](#) and [step 6](#) as necessary.

---

**Note:** If you assign multiple action items to a trigger, you can change the order of execution by dragging items to higher or lower positions in the list. When the background action is triggered, its associated action items are executed in order from top to bottom.

---

- 8 Click the Save button on the toolbar.
- 9 Export the database to the multiviewer.

## Creating a Background Action from the System List

### To create a background action from the System list

- 1 In the **Description/Calibration** tab (or in any other tab that shows a filtered System list with alarms), right-click the alarm you wish to associate with an action.

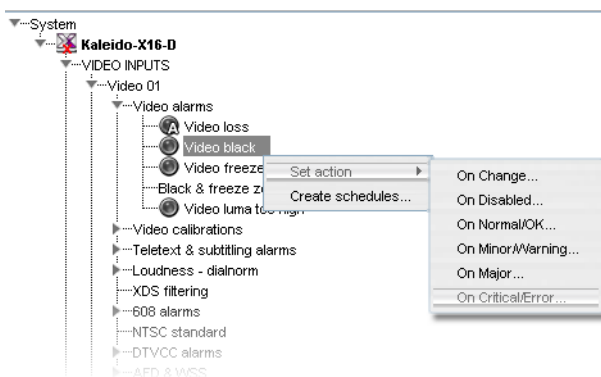

- 2 On the **Set action** menu, select the appropriate trigger condition:
  - On Change
  - On Disabled
  - On Normal/OK
  - On Critical/Error

---

Note: The trigger conditions **on Minor/Warning** and **on Major** are supported for Gateway alarms only.

---

The **Action Editor** window appears.

- 3 From the **Action list** pane, drag one of the available action items to the middle column, and then set the action item's properties in the **Properties** pane.

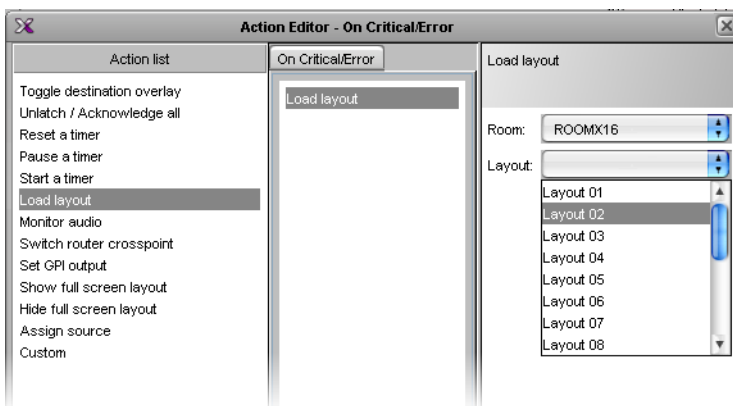

- 4 Repeat [step 3](#) as needed.
- 5 Click **OK** to close the window, and then click the Save button on the toolbar, to save the action.
- 6 Export the database to the multiviewer.

## Creating an Action that can be Triggered via a Gateway Command

### To create an action that can be triggered via the Gateway

- 1 Perform [step 1](#) to [step 3](#) from [Creating Background Actions](#), on page 304.
- 2 From the **Action list** area of the **Tools** pane, drag one of the available action items onto the **On Change / Gateway** column at the bottom of the **Actions** pane.

## Creating Actions Creating Background Actions

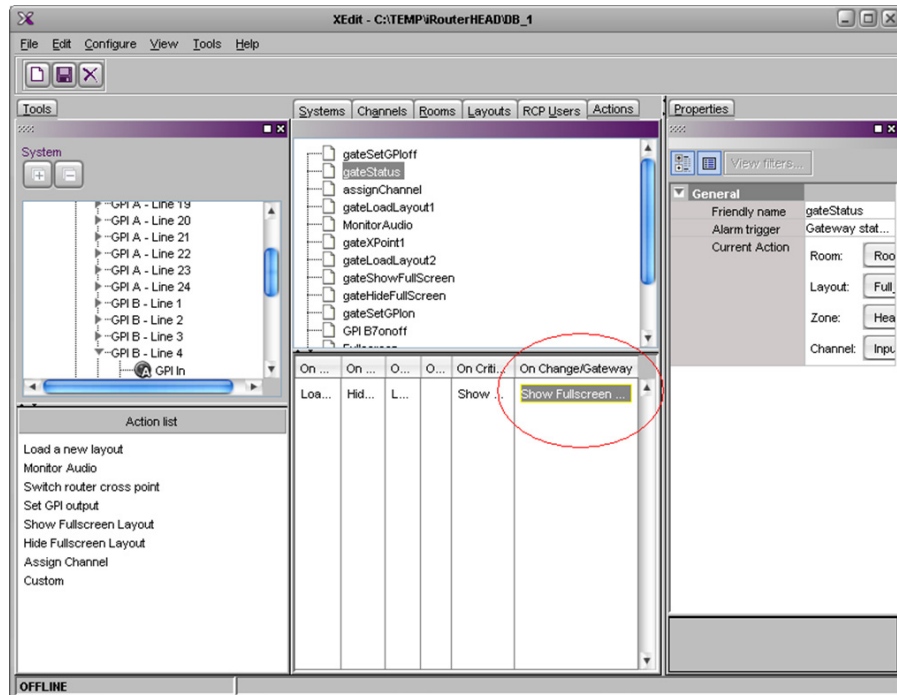

### 3 Under Properties > General, type a Friendly name for the Action.

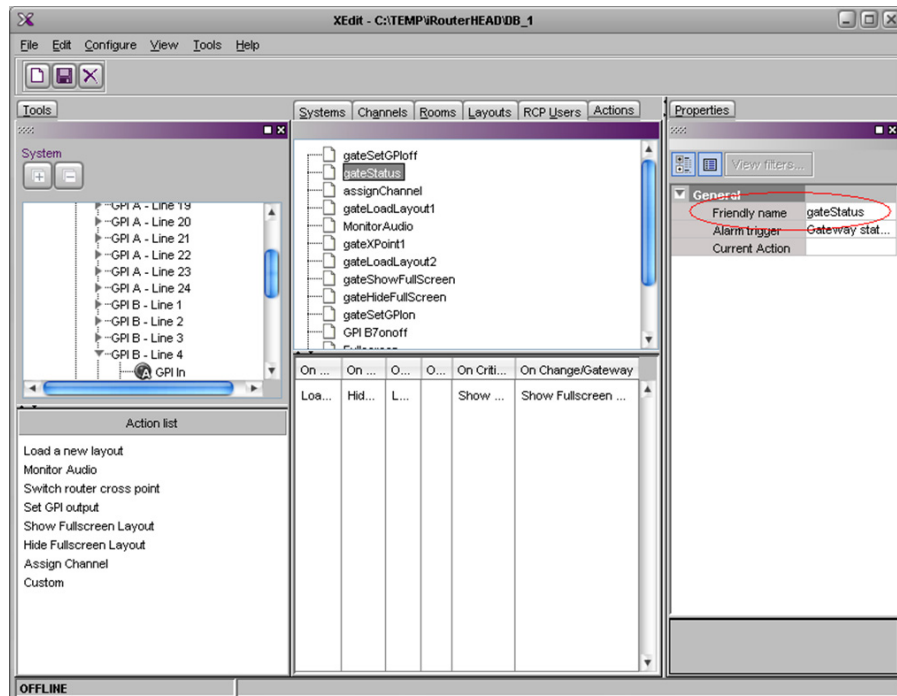

**Note:** The **Friendly name** is used with the `setKFireAction` command to trigger the action. Refer to the *Kaleido Remote Control Protocol (Gateway) User's Guide* for details.



## Editing an Action

### To edit an action

- 1 Select an action under the **Actions** tab, or in the middle pane of the **Action Editor** window.
- 2 Under the **Properties** pane, modify the action item's parameters
- 3 Click Save on the toolbar if you modified the action under the **Actions** tab, or click **OK** if you modified the action in the **Action Editor** window.
- 4 Export the database to the multiviewer.

## Removing Action Items from an Action

### To remove an action item from an action

- 1 Select an action under the **Actions** tab, or in the middle pane of the **Action Editor** window.
- 2 Select one or more action items associated with the action.
- 3 Press the Delete key.
- 4 Click Save on the toolbar if you modified the action under the **Actions** tab, or click **OK** if you modified the action in the **Action Editor** window.
- 5 Export the database to the multiviewer.

## Deleting an Action

### To delete an action

- 1 Select the action you wish to delete under the **Actions** tab.
- 2 Click the Delete button on the toolbar.
- 3 Click Save on the toolbar if you modified the action under the **Actions** tab, or click **OK** if you modified the action in the **Action Editor** window.
- 4 Export the database to the multiviewer.



# 11

## Managing RCP Users

This chapter explains the configuration of a Kaleido multiviewer for use with a Kaleido-RCP2, an RCP-200 Remote Control Panel, or from the Gateway.

### Summary

<i>Managing RCP Users</i> .....	312
<i>Managing Room Access</i> .....	313
<i>Setting Room Preferences</i> .....	313
<i>Setting RCP User Preferences</i> .....	316

### XEdit Quick Start Task List

Follow these steps in XEdit, to set up your RCP Users' profiles:

- 1 Create an RCP user. See [Managing RCP Users](#) on page 312.
- 2 Grant room access to the RCP user. See [Managing Room Access](#) on page 313.
- 3 Select the configuration of the external keyboard for this user. See [Setting the Keyboard Language](#) on page 319.

### Key Concepts

#### Kaleido-RCP2

The Kaleido-RCP2 is a multi-function remote control panel designed for use with Grass Valley's Kaleido-X software. Ethernet connectivity allows multiple RCP users to access multiple Kaleido-X systems, allowing convenient access to their real-time operating features.

The XEdit application is used to manage certain aspects of the Kaleido-RCP2.

#### RCP-200

The RCP-200 advanced remote control panel for Densité cards, Kaleido multiviewers, and NVISION/third party routers provides a highly intuitive graphical interface. It simplifies video/audio signal processing and control in both single and multi-user environments.

The XEdit application is used to manage certain aspects of the RCP-200.

## Detailed Directions

### Managing RCP Users

#### Adding RCP Users

##### To add an RCP user to the system

- 1 In the main window, click the **RCP users** tab.
- 2 In the **Tools** pane, right-click anywhere in the **RCP users** area, and then click **New user** on the menu.

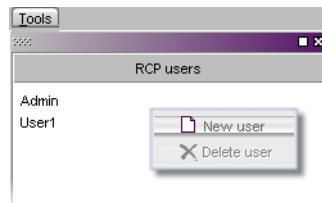

A new user is added to the **RCP users** list.

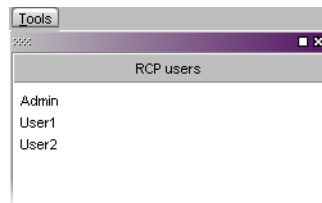

---

#### Notes

- New users are called UserN, where N = 1, 2, 3 etc.
  - RCP users can be renamed. See [Changing an RCP User's Name and Password](#) on page 321.
  - New users are saved automatically; it is not necessary to click the **Save** button after adding a user to the system.
- 

#### Removing RCP Users from the System

##### To remove an RCP user from the system

- 1 In the main window, click the **RCP users** tab.
- 2 In the **Tools** pane, select the user you wish to remove from the system's RCP users list.
- 3 Right-click the selection, and then click **Delete user** on the menu.

A confirmation window appears.

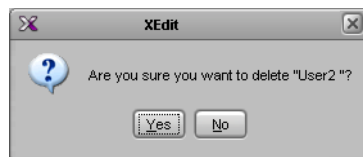

- 4 Click **Yes**.

- 5 On the **File** menu, click **Save**.

---

Note: The user "Admin" cannot be removed.

---

## Managing Room Access

### Granting Room Access to RCP Users

#### To grant RCP users access to a room

- 1 In the main window, click the **RCP users** tab.
- 2 In the **Tools** pane, select the appropriate users from the RCP users list.

---

Note: Use Shift+click or Ctrl+click to select multiple users.

---

- 3 Drag the selected users onto the appropriate room in the **RCP users** tab.
- 4 Expand the room (if it is not expanded already) to verify that the users were added.

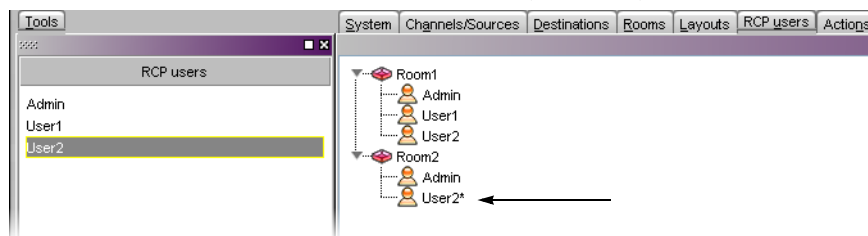

*RCP user "User2" has been granted access to Room2*

- 5 On the **File** menu, click **Save**.

### Removing RCP Users from Rooms

#### To remove RCP users from rooms

- 1 In the main window, click the **RCP users** tab, expand the appropriate rooms if needed, and then select the users you wish to remove.

---

Note: Use Shift+click or Ctrl+click to select multiple users.

---

- 2 On the **File** menu, click **Remove user from room**. Alternatively, click the Remove button  on the toolbar, or right-click and then click **Remove user from room** on the menu.
- 3 On the **File** menu, click **Save**.

---

Note: The user "Admin" cannot be removed.

---

## Setting Room Preferences

Room preferences will apply by default for any user who log on to the room from a Kaleido-RCP2, or RCP-200 control panel. See [Setting RCP User Preferences](#) on page 316, to learn how to configure preferences for a specific user.

### To set default preferences for a room

- 1 In the main window, click the **RCP users** tab, and then select the appropriate room. The selected room's preferences (layout presets, audio monitoring output, mouse pointer size, and timer) are listed in the **Properties** pane.

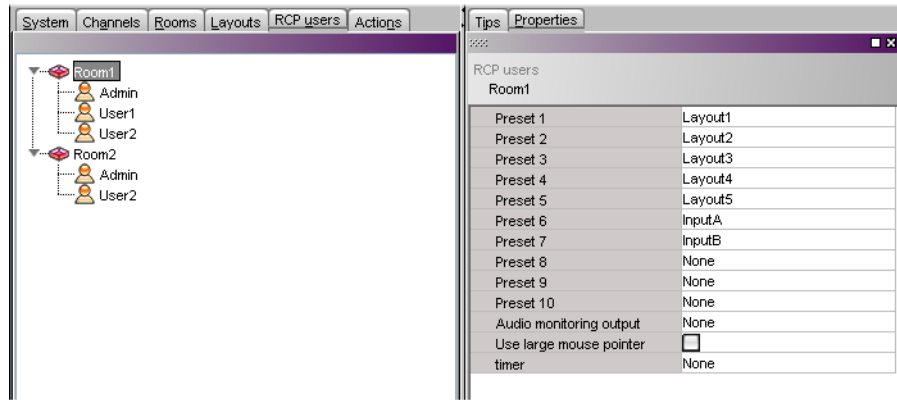

- 2 Modify the room preferences as needed.

**Note:** An asterisk (\*) will appear beside the room in the main pane, if any of its properties are modified. The asterisk will disappear when the changes are saved.

- 3 On the **File** menu, click **Save**.

### Assigning Room Layouts to the Kaleido-RCP2 Preset buttons

#### To assign room layouts to the Kaleido-RCP2 preset buttons

- 1 In the main window, click the **RCP users** tab, and then select the room for which you wish to configure layout presets, from the hierarchical list.
- 2 For each Kaleido-RCP2 preset button, click the corresponding box in the **Properties** pane, and then select the appropriate layout from the list.

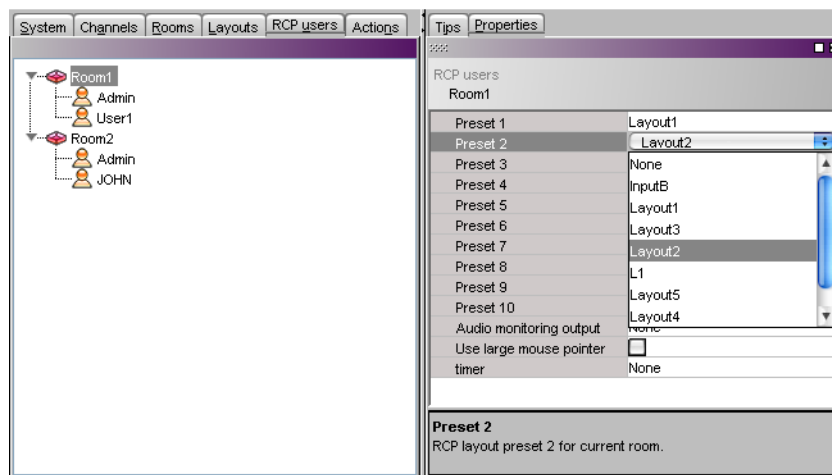

## Assigning an Audio Output to the Remote Control Panel's AUDIO MONITORING Button

To assign an audio output to the Remote Control Panel's AUDIO MONITORING button for a room

- 1 In the main window, click the **RCP users** tab, and then select the room for which you wish to configure the remote control panel's AUDIO MONITORING button, from the rooms hierarchical list.
- 2 In the **Properties** pane, click the **Audio monitoring output** box, and then select the output used to monitor audio signals, from the list of available outputs.

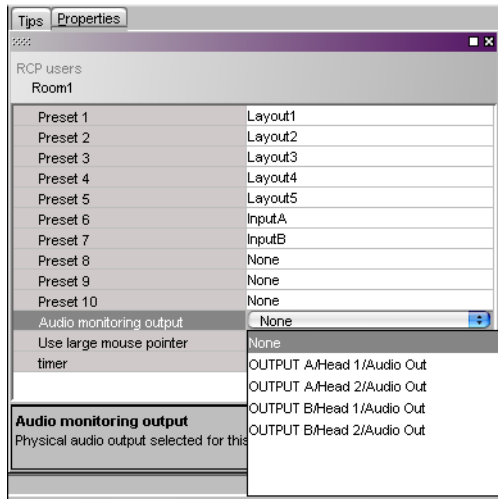

## Enabling the Large Mouse Pointer for a Room

To display a larger pointer on the monitor wall for a room

- 1 In the main window, click the **RCP users** tab, and then select the room where you wish to use a large pointer on the monitor wall.
- 2 In the **Properties** pane, select the **Use large mouse pointer** check box.

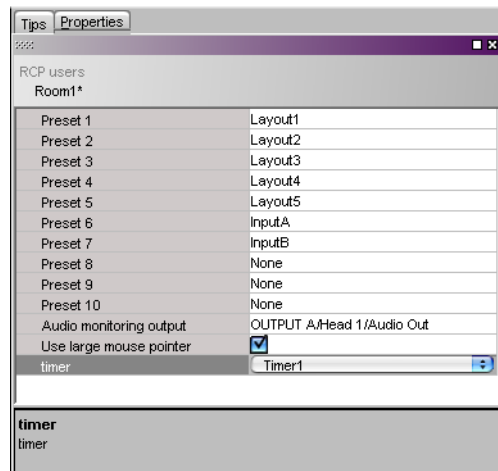

---

**Note:** When the large mouse pointer option is enabled for a room, the menus also appear in a larger font size on the monitor wall displays associated with this room.

---

## Assigning a Timer to a Room

### To assign a default timer for all RCP users in a room

- 1 In the main window, click the **RCP users** tab, and then select the room to be assigned a timer, from the hierarchical list.
- 2 In the **Properties** pane, click the **Timer** box, and then select the appropriate timer to be controlled by default from this room.

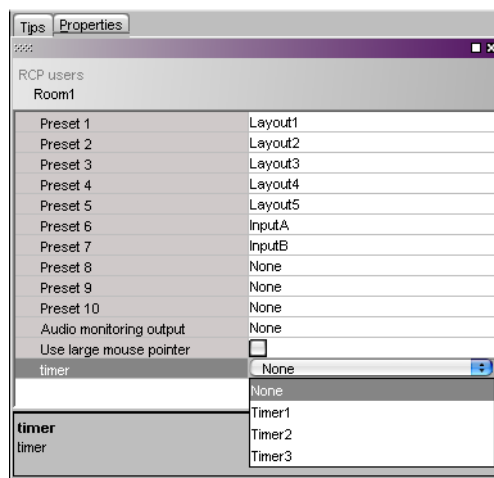

## Setting RCP User Preferences

### To modify the preferences for an RCP user

- 1 In the main window, click the **RCP users** tab, and then select the user whose preferences you wish to set, from under the appropriate room, in the hierarchical list. The selected RCP user's preferences (layout presets, full screen assignment, audio monitoring output, external keyboard configuration, and timer) are listed in the **Properties** pane.
- 2 Modify the preferences as needed. See [Assigning Room Layouts to a Kaleido-RCP2 User's Presets](#) on page 317, [Assigning a Full Screen Layout to an RCP User](#), on page 318, [Assigning Audio Output to an RCP User](#), on page 318, and [Setting the Keyboard Language](#), on page 319.

---

**Note:** User preferences are specific to an RCP user in a specific room. If no preferences have been specified for an RCP user, then the corresponding room preferences apply. They appear in gray in the **Properties** pane.

---



- 3 Modify the system-level attributes for this user (user name, description, password) as needed. See [Changing an RCP User's Name and Password](#) on page 321.

---

**Note:** These system-level attributes are specific to a user, independent of the room to which the user is assigned.

---

- 4 On the **File** menu, click **Save**.

---

**Notes**

- The "Admin" user name cannot be modified.
  - An asterisk (\*) will appear beside the RCP user in the main window if any of the user properties are modified. The asterisk will disappear when the changes are saved.
  - The message "Cannot find reference" indicates that a full screen layout, full screen zone, or layout associated with a Room or RCP user has been deleted.
- 

## Assigning Room Layouts to a Kaleido-RCP2 User's Presets

### To assign a room layout to a Kaleido-RCP2 user's preset button

- 1 In the main window, click the **RCP users** tab, and then select the user for whom you wish to configure the remote control panel's preset buttons, from under the appropriate room in the hierarchical list.
- 2 For each Kaleido-RCP2 preset button, click the corresponding box in the **Properties** pane, and then select the appropriate layout from the list.

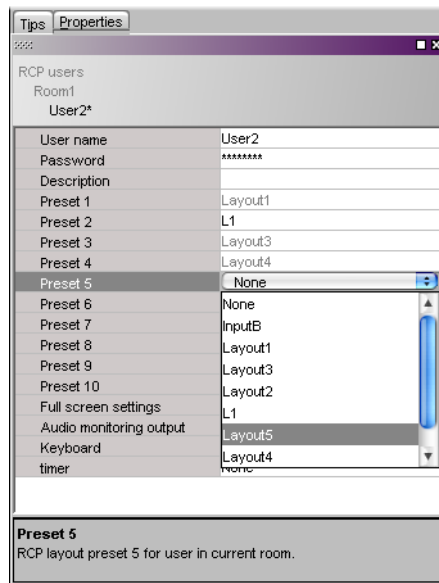

---

**Note:** If no layout is specified for this user preset, the layout that has been selected for this preset in the room's preferences will apply. It will appear in gray in the **Preset [n]** box. See [Setting Room Preferences](#) on page 313.

---

## Assigning a Full Screen Layout to an RCP User

### To assign a full screen layout to an RCP user

- 1 In the main window, click the **RCP users** tab, and then select the user for whom you wish to configure the remote control panel's FULL SCREEN button, from under the appropriate room in the rooms hierarchical list.
- 2 In the **Properties** pane, click the **Full screen settings** box, and then click the button that appeared at the end of the box.

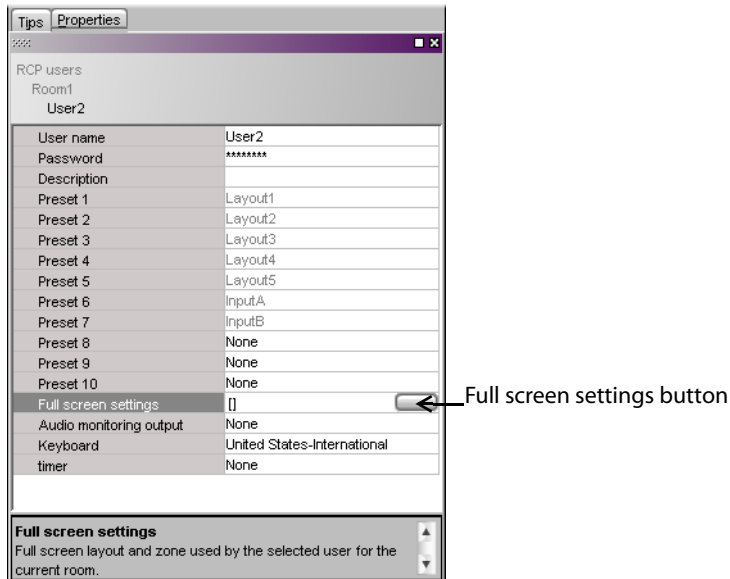

The **Full Screen Settings** window appears.

- 3 In **Full Screen Settings**, select the appropriate full screen layout, and then click **OK**.

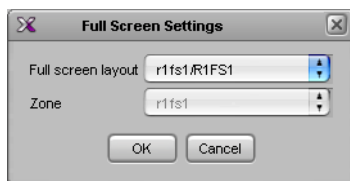

---

**Note:** Before XEdit 2.00, full screen layouts were not associated with a specific full screen zone. In the case of such legacy layouts, you must also select the appropriate full screen zone from the **Zone** list.

---

## Assigning Audio Output to an RCP User

### To assign an audio output to an RCP User

- 1 In the main window, click the **RCP users** tab, and then select the user for whom you wish to configure the remote control panel's AUDIO MONITORING button, from under the appropriate room in the rooms hierarchical list.
- 2 In the **Properties** pane, click the **Audio monitoring output** box, and then select the output used to monitor audio signals by this user in this room, from the list of available outputs.

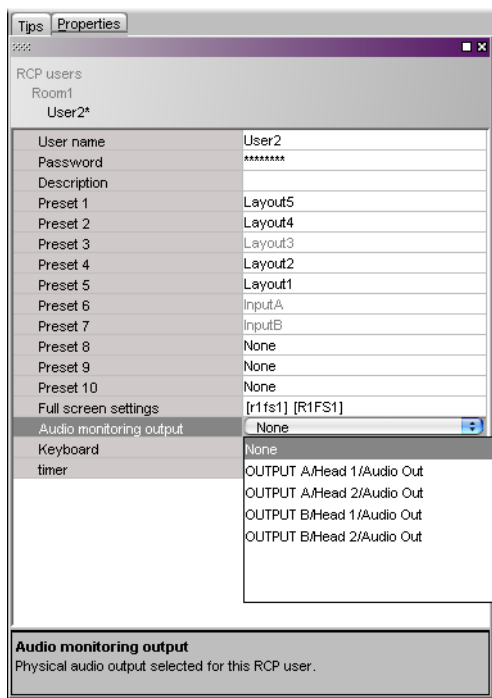

**Note:** If no audio monitoring output is specified for this user, the output signal that has been selected in the room's preferences will apply. It will appear in gray in the **Audio monitoring output** box. See [Setting Room Preferences](#) on page 313.

## Setting the Keyboard Language

To set the input language for an external keyboard connected to the Kaleido-RCP2 or RCP-200

- 1 In the main window, click the **RCP users** tab, and then select the user for whom you wish to set the keyboard, from under the appropriate room in the rooms hierarchical list.
- 2 In the **Properties** pane, click the **Keyboard** box, and then select the keyboard to be used by this user in this room, from the list of available keyboard configurations.

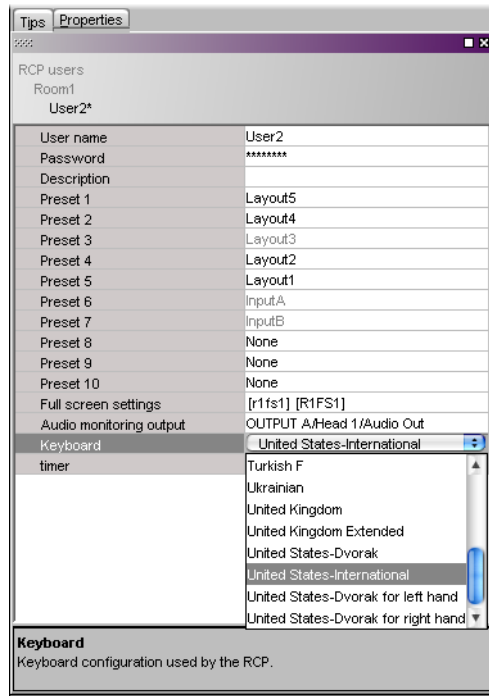

---

**Note:** This setting applies to the selected user, in the current room only. A keyboard configuration must be selected for each user, in every room, unless the system default is suitable.

---

## Assigning a Timer to an RCP User

### To assign a timer to an RCP User

- 1 In the main window, click the **RCP users** tab, and then select the user to whom you wish to assign a timer, from under the appropriate room in the rooms hierarchical list.
- 2 In the **Properties** pane, click the **Timer** box, and then select the appropriate timer to be controlled by this user in this room, from the list of available timers.

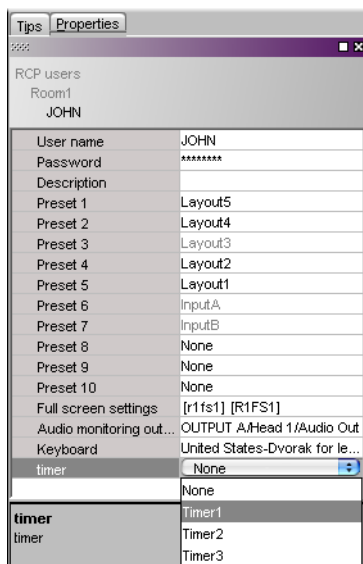

---

**Note:** If no timer is specified for this user, the timer that has been selected in the room's preferences will apply. It will appear in gray in the **Time** box. See [Setting Room Preferences](#) on page 313.

---

## Changing an RCP User's Name and Password

### To change an RCP user's name or password

- 1 In the main window, click the **RCP users** tab, and then select the user whose user name or password you wish to change, from under any of the rooms in the hierarchical list.

---

**Note:** A user's name or password cannot be changed from within the **Tools** pane. They can only be changed from within the rooms hierarchical list. The user can be removed from the room after the name or password change. The change will be retained. See [Granting Room Access to RCP Users](#) on page 313.

---

- 2 In the **Properties** pane, click the **User name** box, and then type the new name.

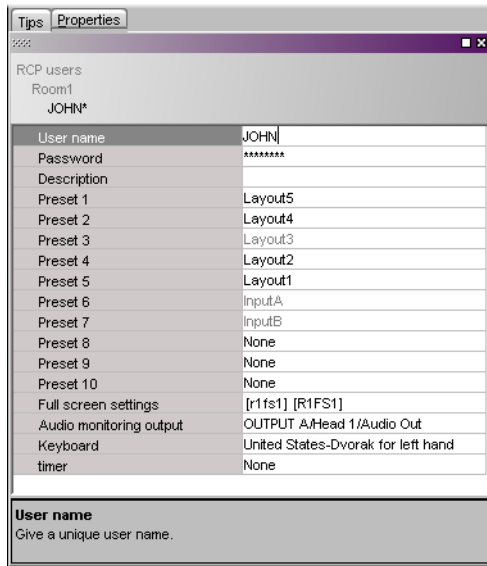

**Note:** The name must be no more than 8 characters in length, and consist of only letters and numbers (no spaces or special characters).

3 In the **Properties** pane, click the **Password** box.

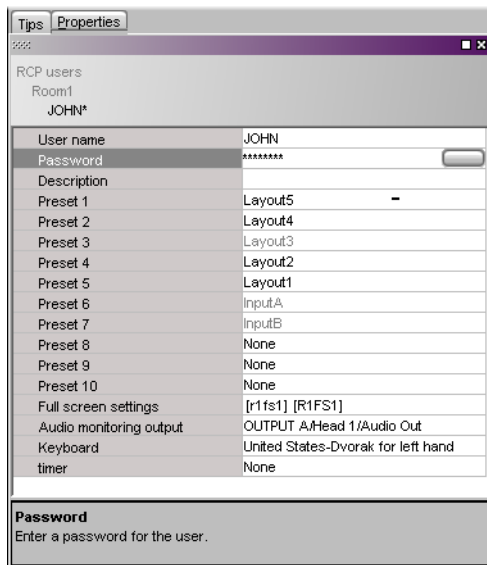

4 Click the button that appeared at the end of the box.  
The **Password Modification** window appears.

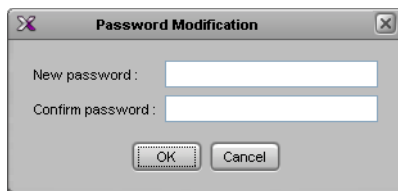

- 5 In **Password Modification**, type the new password (only numbers, up to 8 digits) and then type it again to confirm.
- 6 Click **OK**.





# 12

## Routers & Kaleido-X

This chapter describes how a multiviewer can be configured to control external routers, to act as a router itself, and to be controlled from an upstream router control panel or software.

### Overview

The Kaleido-X, Kaleido-MX, Kaleido-X16, Kaleido-Modular-X, and Kaleido-Modular KMV-3901/3911 multiviewers are designed for flexible integration with a variety of routing devices. A multiviewer can be configured to control, or to be controlled by a variety of routing devices. The Kaleido-X (7RU) and Kaleido-X16 have an internal router option, which offers switching of up to 192 unprocessed inputs to 96 HD/SD outputs (16 inputs to 2 outputs, in the case of the Kaleido-X16), for feeding monitors, test equipment and master control or production switchers. A multiviewer can also be configured as a router and provide switching of its logical sources to router card outputs (if available) or monitor wall destinations.

The Kaleido-X software interfaces with most routing devices, via Ethernet or serial connection, for router control and dynamic text label tracking. The interface allows dynamic source updates from the router, and quick access to any router sources directly from the monitor wall user interface. Kaleido-X can also save source assignments to the layout presets, and reconfigure the router by recalling a layout preset.

For quality control applications, the monitor wall pointer (controlled by a mouse connected via a Kaleido-RCP2 control panel) can be used to assign a selected source to a monitoring output bus. This creates a highly intuitive and rapid quality control capability. Grass Valley (Miranda) has been working closely with Snell (Pro-Bel) and NVISION (eventually acquired by Miranda) to provide a cost-reduced, multi-image/routing solution, with compelling integration and a direct download of sources text databases from routers and production switchers to the multiviewer system.

See [Tally Interface Devices & Timer Systems](#) on page 375 for more information on configuring supported production switchers to interact with the Kaleido-X software.

## Key Concepts

Term	Description
External Router	In XEdit's Equipment library, <b>External Router</b> refers to an upstream router that will be controlled by the multiviewer. For example, the multiviewer can request a specific source from the external router to be routed to a specific video monitor on the monitor wall.
Physical router	In XEdit, a physical router is a software representation of router equipment. Physical routers hold information on how to communicate with the equipment, as well as the number of physical levels associated with the router.
Physical level	Some router equipment can have multiple physical levels, which are subsets of the physical router's inputs and outputs.
Protocol	The instruction set and parameters used to communicate with and control a device. The router protocols supported in iControl are also supported by Kaleido-X, and vice-versa (although there might be a slight lag between the time the latest software versions are released).
Router controller	<i>Router controller</i> refers to any software or hardware that can request a crosspoint change on a router. The Router Control Software Single Bus and Matrix View applications (also part of the iRouter Router Control Software packaged with iControl Application Servers) are examples of router controllers. They are integrated with the Kaleido-X software, and can be launched from the Kaleido-X home page.
Logical router	A logical router is a software abstraction that permits the control of multiple physical routers/levels as a single entity. Logical routers have a unique matrix ID within a router manager.
Logical level	A logical level defines the mapping between logical and physical inputs, and the mapping between the logical and physical outputs.
Matrix ID	A unique identifier used by a router controller to identify which router is the target of a switching command.
<i>KX Router</i> logical router	<p>Independent from the routing capabilities obtained by adding KXO-24Router cards to a Kaleido-X (7RU) multiviewer or by enabling the router output ports on a Kaleido-X16, any multiviewer can be used as a router in itself.</p> <p>The logical sources defined in XEdit's <b>Channels/Sources</b> tab (see <a href="#">page 177</a>) are considered sources for the <i>KX Router</i> logical router, whose destinations are either monitors on the monitor wall, or the multiviewer's own router outputs (if applicable).<sup>1</sup> Source IDs to be used for routing purposes are assigned in XEdit's <b>Channels/Sources</b> tab. These IDs can be used by external router control software or devices. The logical destinations for the <i>KX Router</i> logical router are configured in the <b>Destinations</b> tab.</p> <p>The <i>KX Router</i> logical router configuration is automatically shared between multiviewers and iControl systems, and also between multiviewers and RCP-200 devices with version 1.70 or later.</p>

Term	Description
Router service	The Kaleido-X router service is the software component responsible for communicating with physical routers, and for managing crosspoint change requests coming from router controllers.
Internal Router	<p>The Kaleido-X (7RU) and Kaleido-X16 multiviewers feature built-in routing which eliminates the need for separate routing in control rooms, and provides a significant cost saving. Up to 48 unprocessed, baseband outputs can be provided from any of the 96 HD / SD-SDI inputs to each Kaleido-X (7RU) processor. In the case of a Kaleido-X16, up to 2 baseband outputs can be provided from any of the 16 inputs. These outputs can be used to feed high quality CRT monitors, test equipment such as waveform scopes, as well as ISO recorders. The outputs can even feed other multiviewers.</p> <p>The router outputs can be controlled from the monitor wall menu, by a Nevion (Network Electronics) remote control panel via a serial connection, by a Grass Valley (Miranda/NVISION) system controller via a TCP/IP connection, or by a production switcher's auxiliary bus controls. The router outputs can be controlled by external controllers via the following protocols: VikinX Compact (serial), VikinX Modular (TCP/IP), NVISION (TCP/IP), Snell (Pro-Bel) (serial, TCP/IP) or manually from the Miranda Router Control Matrix application available from the Kaleido-X Web page.</p> <p>The built-in router improves integration, and reduces cabling and equipment costs. The routing capability eliminates the need for a separate router for the following applications:</p> <ul style="list-style-type: none"> <li>• feeding baseband high quality monitors anywhere in a facility</li> <li>• feeding test equipment for quality control monitoring</li> <li>• feeding a secondary multiviewer for output expansion</li> <li>• feeding an ISO recorder in production studios</li> </ul>
Profile	A logical view of an NV9000 routing system represented as a single flat matrix of sources and destinations, regardless of where in the routing system the actual sources and destination may be.

1. i.e. the 24 BNC outputs on a KXO-24Router card for a Kaleido-X (7RU), or the two RT OUT ports on a Kaleido-X16. The other multiviewer models do not have router outputs.

## Router Control Configurations

Multiviewers can be configured for router control in five ways:

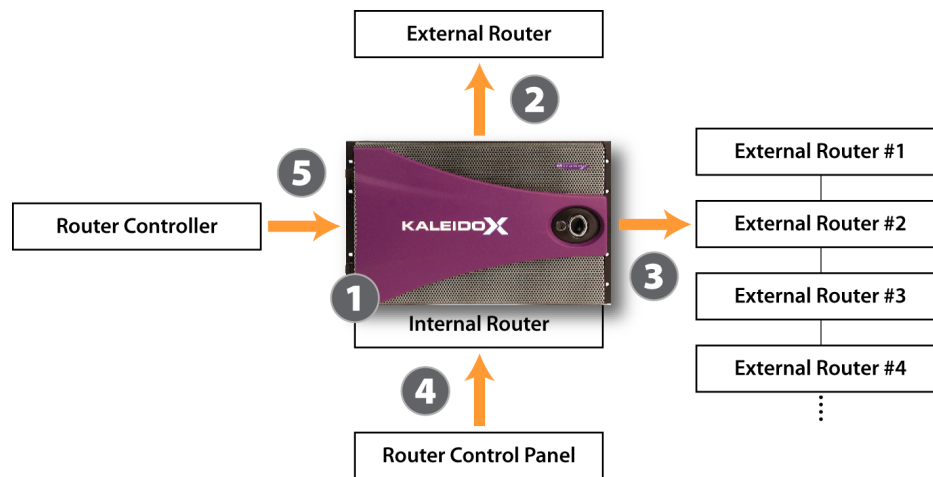

- 1 Kaleido-X (7RU) and Kaleido-X16 multiviewers allow direct control over their own internal router module.
- 2 All multiviewers allow direct control over an external router via a serial or TCP/IP connection.
- 3 All multiviewers allow control over a series of external routers in a cascade configuration: the Kaleido-X software sends a router command to one of the routers via a serial or TCP/IP connection, which then broadcasts it to the other routers in the cascade using an internal communications mechanism (e.g. MIDI). The router command contains an ID that causes it to be accepted by one router in the cascade, and ignored by the rest.
- 4 All multiviewers can be controlled by an external (push-button) control panel, via a serial or TCP/IP connection. Usually, such a panel is used to control either a simple external router (case 2, above) connected to the multiviewer, or the internal router module (case 1, above).
- 5 All multiviewers can be controlled by an intelligent router controller, via a serial or TCP/IP connection. The controller can issue commands to the multiviewer internal router module (if available), or to any external router connected to the multiviewer. The Kaleido-X software directs the commands to the designated device, and, as needed, translates the command to the required protocol.

## Router Configuration Scenarios

### Controlling an external router

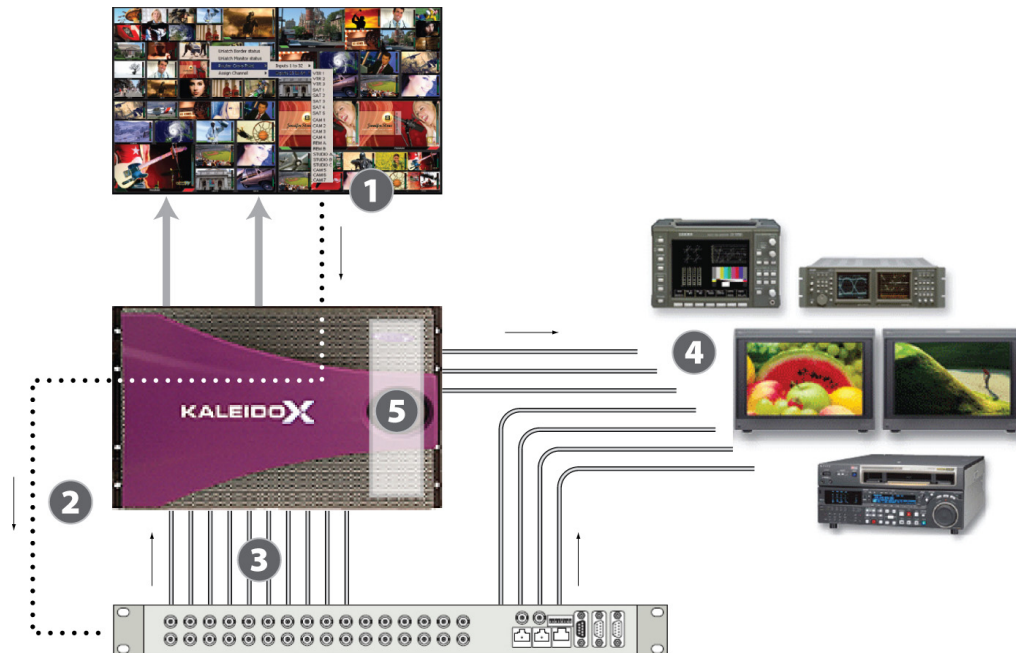

- 1 An operator chooses an assignment option on the monitor wall menu (e.g. “switch output 2 of external router A to QC monitor”).
- 2 The Kaleido-X software interprets the command, and sends it to the designated router over a serial or TCP/IP connection, using the appropriate router protocol.
- 3 The router receives the command and executes a crosspoint switch, either changing the signal on one of its connections to a multiviewer input, or...
- 4 ...sending the signal to another device (e.g. vector scope, QC monitor, ISO recorder).

---

Note: In the same way, from the monitor wall, it is possible to change crosspoints on the multiviewer’s internal router (if available), when its physical levels are configured in the context of the *KX Router* logical router’s *first* level.

---

### Controlling external routers in a cascade

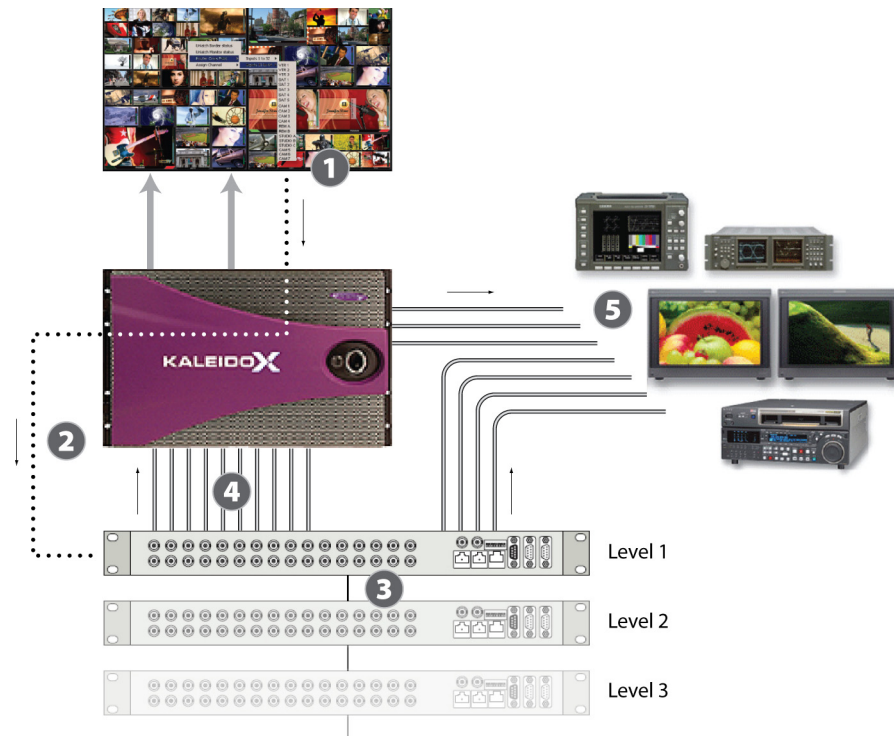

- 1 An operator chooses an assignment option on the monitor wall menu (e.g. “switch output 23 of external router A, Level 2 to QC monitor”).
- 2 The Kaleido-X software interprets the command, and sends it to the designated router over a serial or TCP/IP connection, using the appropriate router protocol.
- 3 The physical router receives the command, and then relays it to the other physical routers in the cascade using an internal communications mechanism (e.g. MIDI).
- 4 When the targeted *Level* receives the command, it executes a crosspoint switch, either changing the signal on one of its connections to a multiviewer input, or...
- 5 ...sending the signal to another device (e.g. vector scope, QC monitor, ISO recorder).

## Translating commands from external router controllers

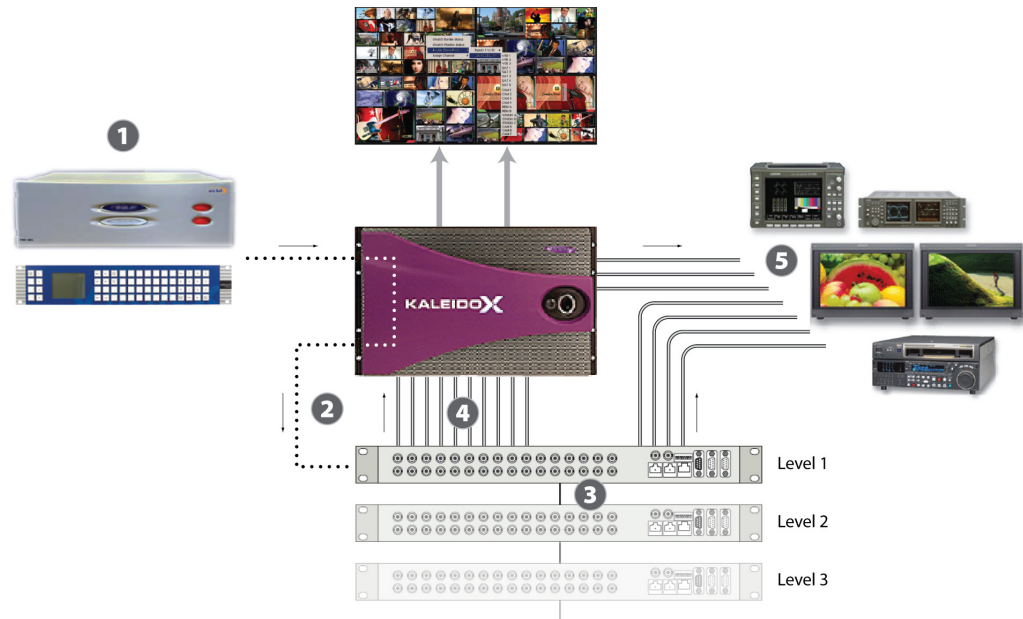

- 1 A system controller—e.g. Grass Valley (Miranda/NVISION) NV9000, Snell (Pro-Bel) Aurora, Nevia (Network Electronics) VikinX—sends a router command to an external router connected to the multiviewer.
- 2 The Kaleido-X software detects the command, translates it to the appropriate router protocol and, then sends it to the designated router over a serial or TCP/IP connection.
- 3 The router (or “Level” in a cascade) receives the command and executes a crosspoint switch, either changing the signal on one of its connections to a multiviewer input, or...
- 4 ...sending the signal to another device (e.g. vector scope, QC monitor, ISO recorder).

## Controlling the internal router by using a router control device or application



- 1 An external router control device or application—e.g. Snell (Pro-Bel) Aurora, Nevion (Network Electronics) VikinX—or an automation system—e.g. Sundance Digital Titan—sends a command, over a serial or TCP/IP connection, to the multiviewer.
- 2 The Kaleido-X software detects the command, and executes a crosspoint switch on its internal router...
- 3 ...sending the selected signal from the corresponding multiviewer input to another device (e.g. vector scope, QC monitor, ISO recorder).

## Router Protocols

### Optional Drivers for Controlling Routing Devices from the Multiviewer

Optional drivers are available to extend your Kaleido-X system with the ability to control routing devices that comply with the protocols listed in the following table. Contact your sales representative for details.

Company	Protocol	Text database download	Routers/Controllers
Datatek	D-2815 Control Module Protocol	No	
ETL	ETL Matrix	Yes	ETL Matrix
Evertz	Quartz Type 1	Yes	EQX
Imagine Communications (Harris/Leitch)	Harris XY Passthrough Protocol	No	Platinum, Xplus, Integrator, Via-32, Panacea, Xpress
Lantronix	(Lightwave) Matrix-Hub Protocol	No	Matrix-Hub 1000
Grass Valley (Miranda)	Densité	Yes	HRS-1801
		No	HCO-1821, HCO-1822
Grass Valley (Miranda/NVISION)	NVISION Ethernet protocol - Enterprise router (Logical) <sup>1</sup>	Yes	NV9000 system controllers
	NVISION Ethernet protocol - Enterprise router (Physical) <sup>2</sup>	Yes	
	NVISION Ethernet protocol - Enterprise router (Device ID based) <sup>3</sup>	Yes	
	NVISION Ethernet protocol - Compact router	No	Compact router series



Company	Protocol	Text database download	Routers/Controllers
Grass Valley (Thomson/Philips) <sup>4</sup>	GVG 7000 Native Protocol <sup>5</sup>	Yes	Concerto-series routers, Encore-series control panels
	Jupiter ASCII communications protocol	No	Jupiter VM-3000 system controller, Venus-series and Trinitix-series routers
	ES-Switch protocol (serial) <sup>6</sup>	Yes	Jupiter VM-3000 system controller
Nevion (Network Electronics)	Network Compact (serial)	No	VikinX Compact
	Network Modular (Ethernet)	No	VikinX Modular
PESA	USP (Unsolicited Status Protocol)	No	Cheetah, Tiger, Jaguar, Cougar, Ocelot, Bobcat, TDM3000, PERC2000 system controller
	CPU Link Protocol No.1 (serial)	No	
Quintech	XRM/SRM/MRF/MRM Series Protocol (serial)	No	SRM 2150 Matrix Switching Systems
Snell (Pro-Bel)	General Switcher Protocol (SW-P-02)	No	
	General Remote Protocol (SW-P-08)	Yes	Halo, Aurora and Sirius Controller (serial control)
Sony	Sony HKSPC (GVGNP Emulator)	No	Sony routers (requires HKSPC card); GVG routers (Ethernet)
Utah Scientific	PL-160/PL-320	No	AVS-1B
	RCP-1	No	SC-1, SC-2, SC-3 series
	RCP-3	Yes	SC-4 series (Ethernet only)

1. Deprecated. To be used with legacy configurations only.

2. To be used in most cases. Supports native locks, and aliases from router (provided system controller has NV9000 router control system version 6.0.6 or later)

3. To be used in very specific scenarios involving physical router interconnects with tie lines, or with hybrid router configurations. Contact Technical Support for more information (see [Contact Us](#), on page 529).

4. Our current implementations of the protocols listed above for Grass Valley (Thomson/Philips) routers and controllers support neither the CM-4400 nor the CM-4000 system controllers.

5. For Thomson / Grass Valley Series 7000 devices, our current implementation of the Series 7000 Native Protocol supports serial devices, in addition to some Encore system controller models, which are also supported over Ethernet. For other Series 7000 devices you wish to control via Ethernet, use Sony HKSPC (GVGNP Emulator).

6. In the case of the Kaleido-X, and Kaleido-X16 multiviewers, the ES-Switch protocol is only supported with a baud rate of 19200.

## Built-in Communications Protocols

The multiviewer itself can be controlled by external devices (e.g. Kaleido-RCP2, router control panels) or applications (e.g. router control software application, Remote Control

Gateway) via built-in communications protocols. Such devices or applications can be used to command monitor wall operations (e.g. source assignment) or routing operations.

A router control device or application can control a Kaleido-X (7RU) or Kaleido-X16 multiviewer's internal router module, or any multiviewer's logical sources and monitor wall destinations, via the *KX Router* logical router. It can also control other logical routers configured within your multiviewer system. In the case of the *KX Router* logical router, the device or application must support the *NVISION Ethernet protocol - Compact router* protocol.

The supported communications protocols are listed in the following table, with an indication of the supported connection types (TCP/IP or serial), and the dedicated port number on the multiviewer, in the case of a TCP/IP protocol.

Company	Protocol	TCP/IP (port)	Serial
Grass Valley (Miranda)	Kaleido Remote Control Protocol	Yes (13000)	Yes
Grass Valley (Miranda/NVISION)	NVISION Ethernet protocol - Compact router	Yes (5194)	No
Nevion (Network Electronics)	Network Compact	N.A.	Yes
	Network Modular	Yes (4381)	No
Snell (Pro-Bel)	SW-P-08	Yes (14000)	Yes
	SW-P-02	Yes (2000)	Yes

## Serial Connections

The physical cabling required to connect a multiviewer to an external serial device (such as a router, production switcher, or router controller) can vary from one device to another. It is important to check the manufacturer's documentation to get the proper pinout so it matches up with the multiviewer.

The RS-422 ports at the back of a Kaleido-X16 multiviewer or at the back of a KXO-Dual or KXO-Dual3 card (in the case of the Kaleido-X multiviewer models) use an RJ-45 connector. Grass Valley provides two adapters, which map the RS-422 signals to the more common DE-9 form factor:

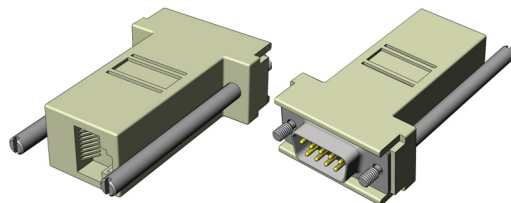

- To connect a serial device whose RS-422 port is wired to the SMPTE *slave* wiring specifications, use the **straight** adapter (Grass Valley part number **1737-3000-102**).
- To connect a serial device whose RS-422 port is wired to the SMPTE *master* wiring specifications, use the **crossover** adapter (Grass Valley part number **1792-3700-100**).

The DE-9S pinouts for these two adapters are as follows:

Pin	Straight adapter (1737-3000-102)	Crossover adapter (1792-3700-100)
1	Not connected	Not connected
2	RX-	TX-
3	TX+	RX+
4	Not connected	Not connected
5	Not connected	Not connected
6	Not connected	Not connected
7	RX+	TX+
8	TX-	RX-
9	Not connected	Not connected

---

Note: Some routers have RS-232 ports, which will require the use of a RS-232 to RS-422 converter (externally powered ones work best).

---

### Sample Third-Party Serial Pinouts

#### Example #1: Ross Synergy100 (RS-422)

1	Not connected	4	Ground	7	TX+
2	TX-	5	Ground	8	RX-
3	RX+	6	Not connected	9	Not connected

The Grass Valley 1737-3000-102 (**straight**) adapter can be connected directly to the Ross Synergy 100:

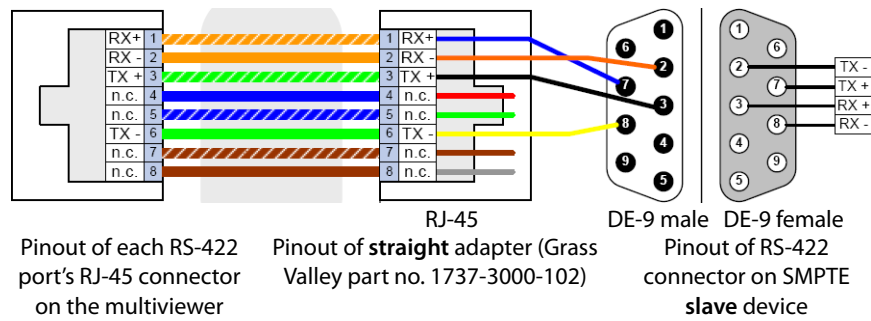

Standard wiring between multiviewer and devices wired to SMPTE "slave" specification (e.g. most routers, Ross Synergy switchers, Neveon ETH-CON)

### Example #2: Philips VM-3000 (RS-422)

1	Ground	4	Not connected	7	RX+
2	RX-	5	Not connected	8	TX-
3	TX+	6	Not connected	9	Not connected

The Grass Valley 1792-3700-100 (**crossover**) adapter can be connected directly to the Philips controller:

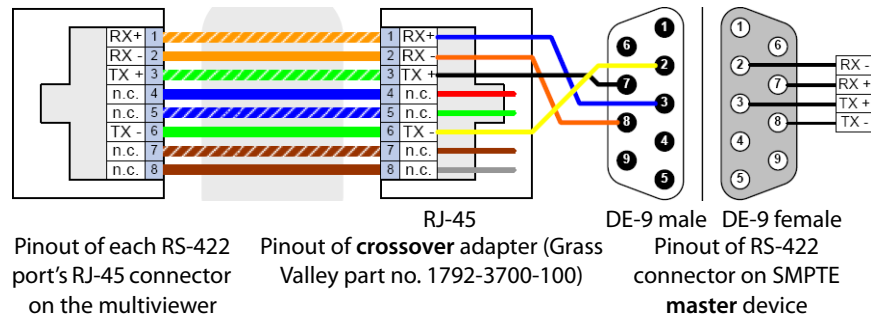

Standard wiring between multiviewer and devices wired to SMPTE "master" specification (e.g. Philips Jupiter router control system, Miranda Presmaster PCS)

Alternatively, use the Grass Valley 1737-3000-102 (straight) adapter but with a crossover cable between the multiviewer and the adapter.

## Q & A

**Q:** Is the internal router used to change inputs to the multiviewer in order to direct signals to the monitor wall?

**A:** No, an internal router card is not needed to display video on the monitor wall. The outputs of the internal router do not feed into the multiviewer's inputs—they come from the multiviewer's inputs via the midplane.

**Q:** What is the main purpose of having an internal router?

**A:** The internal router allows you to share the inputs connected to a Kaleido-X or Kaleido-X16 multiviewer with other equipment (e.g. QA monitors, vectorscopes),

reducing or eliminating the need to have an expensive standalone external router. The internal router allows you to have one piece of equipment (the multiviewer) that serves two integrated purposes: displaying video inputs on the monitor wall, and sharing them with other equipment. For example, instead of having a router in front of the multiviewer to split feeds between the multiviewer and a vectorscope monitor, you can use the multiviewer as a router. Your feeds enter at a single point, and one of the outputs can go to a vectorscope or quality control (QC) monitor, so that instead of a large, expensive station router in front you can have a smaller one—you don't lose outputs for QC.

**Q:** Is there a matrix GUI available for controlling routers via the multiviewer?

**A:** Yes. The Kaleido-X software (version 4.00 and later) incorporates the single bus and matrix view from iControl Router Control Software.

**Q:** Is the "External Router" item in the Equipment library always used to add a router?

**A:** Yes. This is done for consistency with iControl. Other types of equipment (production switchers, controllers, tally boxes) have their own specific entries in the Equipment library.

**Q:** Can there be more than one external router?

**A:** Yes. Every router or router control panel that is connected to a serial port on the multiviewer corresponds to an *External Router* in XEdit. Similarly, every router with a unique IP address connected via TCP/IP to the multiviewer is considered a unique External Router. If the multiviewer is connected to a series of physical routers in a cascade configuration, the cascade corresponds to a single External Router in XEdit, where each router is a *Level*.

**Q:** Why was the iControl Router Manager integrated into XEdit version 3.00?

**A:** Previously, a version of the iControl Router Manager appeared as a separate application within XEdit. This could lead to some issues, such as two devices being configured on the same serial port. Since Router Manager is now integrated, XEdit is more "aware" of the router configuration information, and can prevent such misconfigurations.

**Q:** Is router management backward compatible?

**A:** Yes. Router configurations made in version 2.20 will be preserved when upgrading to version 3.00 (or later). However, even though this has been tested on a large number of configurations, it is recommended that the router settings be reviewed before and after the upgrade in order to ensure that there are no errors.

**Q:** What is a "Network router"?

**A:** The phrase "Network router" has the obvious connotation of a router available on a network. However, in the context of Grass Valley's Monitoring and Control applications, it can also refer to a device now manufactured by Nevision ([www.nevision.com](http://www.nevision.com))—formerly Network Electronics Ltd.—such as a VikinX router.

**Q:** What are the three different Router Controller items (i.e. Network Compact and the two Pro-Bel items) in the Equipment library?

**A:** They are all used for controlling either the multiviewer's internal router, or any logical router.<sup>3</sup> The only difference is the protocol used to communicate with the multiviewer.

**Q:** My internal router card shows up in the Routers list in XEdit as "OPTION A (Video 120 × 48)". Does this mean it has 120 inputs and 48 outputs?

**A:** No. Each card can route up to 96 inputs to 24 physical outputs, and so has an actual size of 96 × 24. "120 × 48" refers to the size of the router card when including other internal connections that are used for router expansion.

## Detailed Directions

### Importing Router Configurations from an NV9000 System Controller

XEdit can import router configurations from an NV9000 system controller and share its *KX Router* logical router's configuration with iControl Application Servers and RCP-200 Advanced Remote Control Panels. Refer to the "Component Compatibility" section of the Kaleido-X Release Notes for related version information.

Although it is possible to partly configure your system by using XEdit in offline mode, you must work in online mode, to import NV9000 router configurations (see [Using XEdit Online](#), on page 75).

---

**Note:** The current version of the Kaleido-X software does not officially support aliases. If you wish to include aliases from an NV9000 router configuration within your multiviewer configuration, please contact Technical Support (see [Contact Us](#), on page 529).

---

#### To import external router configurations from an NV9000 system controller

- 1 In XEdit's main window, click the **System** tab, and then click **Router configurations** on the second-level tab bar.
- 2 In the **Tools** pane, click the **Physical routers** folder.

---

3. Controlling a logical router from an upstream router control device or application is supported since version 3.00 of the Kaleido-X software.

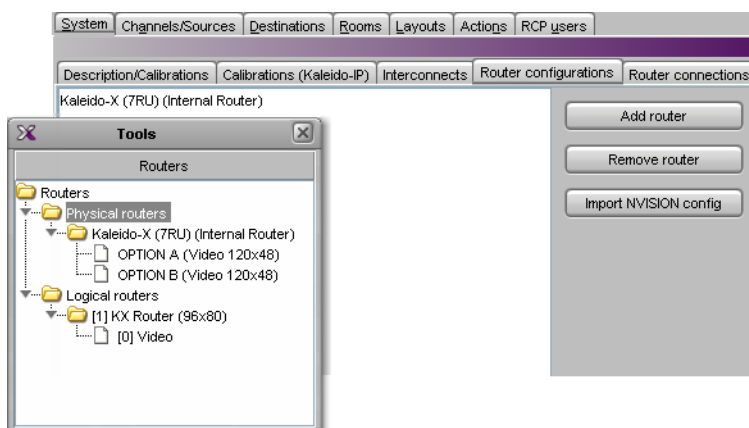

3 Click **Import NVISION config**.

The **Import Configuration** window appears.

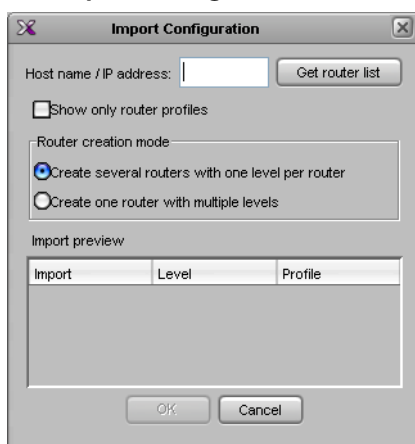

4 In **Import Configuration**, type the host name or IP address of the NV9000 system controller, click **Show only router profiles** if appropriate, and then click **Get router list**.

#### IMPORTANT

**The number of outputs on a physical router may impact performance, both on the multiviewer and on the NV9000.**

If your physical routers have more than a few hundred outputs, Grass Valley recommends that you create profiles (see [Profile](#), on page 327), limited to the necessary outputs for your monitoring purposes, in NV9000-SE Utilities, and then import those profile configurations instead of the full router configuration into your multiviewer system configuration.

*All physical levels and profiles* known to this NV9000 system controller appear under **Import preview**.

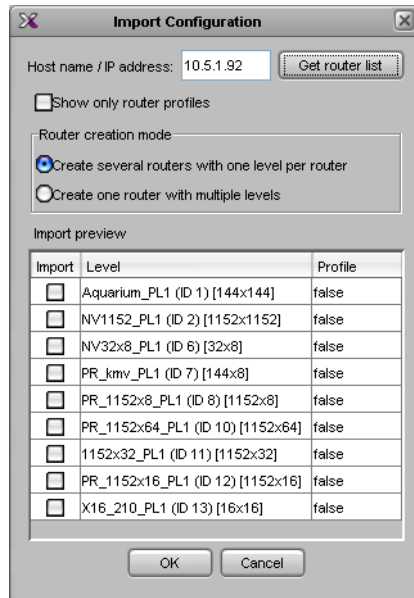

The name of every NV9000 physical level or profile is followed with an ID, and dimensions. For example, in the case of *NV32X8\_PL1 (ID 6) [32x8]* above, the part *NV32X8\_PL1* is the name of an NV9000 physical level, whose ID (internal to the NV9000 system) is 6, and which has 32 sources and 8 destinations.

---

**Note:** You can see these NV9000 physical level names and IDs in NV9000-SE Utilities *PhysLevels* table. Refer to the NV9000-SE Utilities User's Guide, for more information.

---

- 5 Select the router creation mode that best suits your purposes.
  - By default, **Create several routers with one level per router** is selected, which means that XEdit will create one single-level physical router and one single-level logical router, for every selected router or profile. This is appropriate from most use cases.
  - If you wish to have only one router with several levels instead, select **Create one router with multiple levels**.
- 6 Select the NV9000 physical levels or profiles you wish to control from your multiviewer, by clicking the corresponding check boxes.



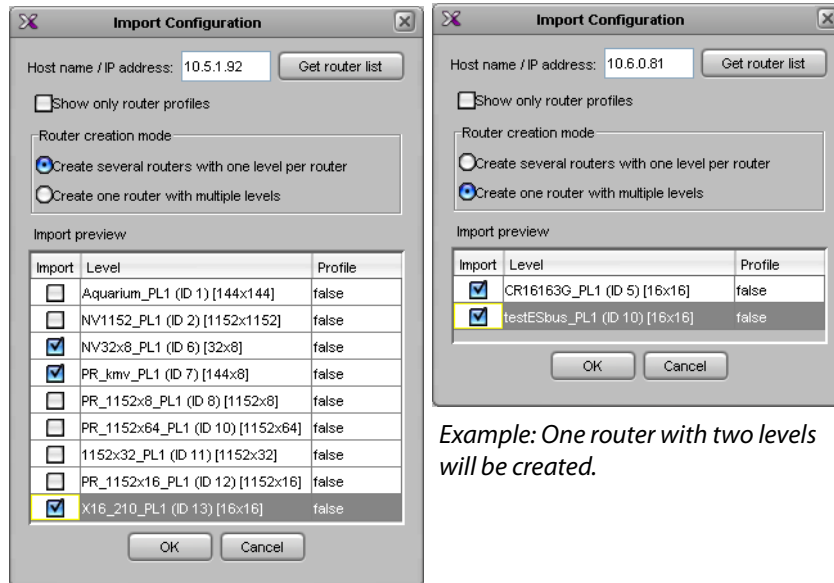

Example: One router with two levels will be created.

Example: Three routers will be created.

7 Click **OK**.

The selected router configurations are imported into your multiviewer system.

- If you selected **Create several routers with one level per router**, then, once the import has completed, your multiviewer's configuration includes new external routers whose names are based on the NV9000 system controller's IP address prefixed with *N9000*, and followed with the ID of the NV9000 physical level (e.g., "N9000 10.5.1.92 6," where "10.5.1.92" is the controller's IP address, and "6" is the NV9000 physical level ID).

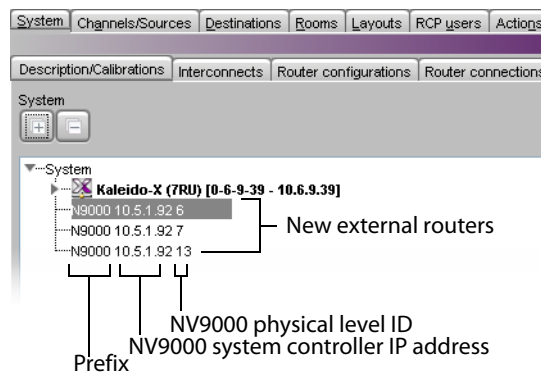

Three external routers were added to the system.

The Routers list includes new physical, and logical routers with the same names. The new physical routers and associated logical routers have one level for every router you imported from the NV9000 system controller.

## Routers & Kaleido-X

### Importing Router Configurations from an NV9000 System Controller

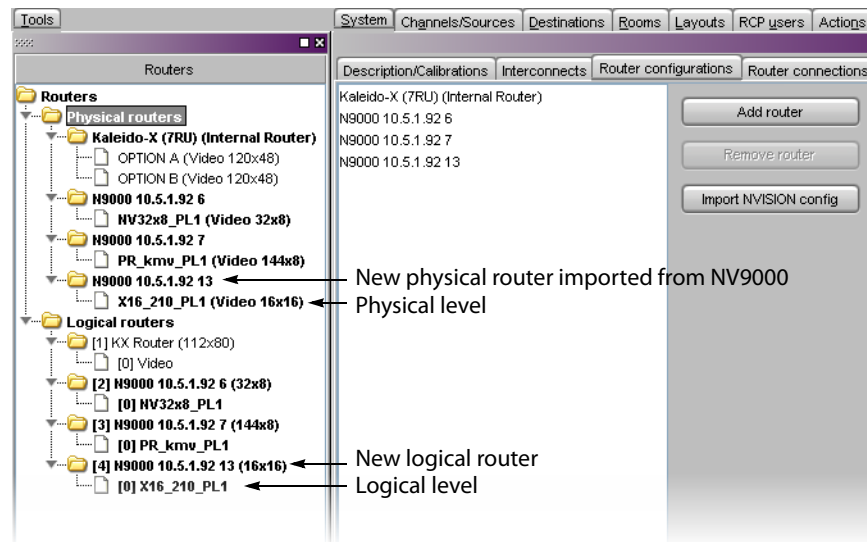

Three physical routers, and three logical routers were added, each with a single level whose name matches the name of the corresponding NV9000 physical level.

- If you selected **Create one router with multiple levels**, then, once the import has completed, your multiviewer's configuration includes *one* new external router whose name is based on the NV9000 system controller's IP address prefixed with *N9000* (e.g., "N9000 10.6.0.81").

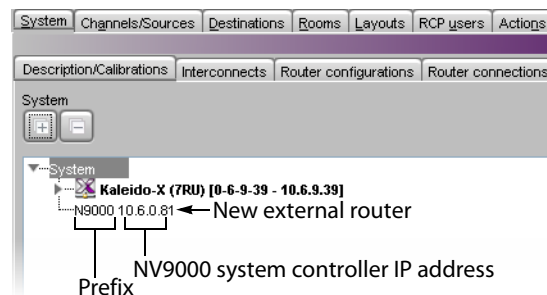

One external router was added to the system.

The Routers list includes *one* new physical router, and *one* new logical router with the same name. The new physical router and associated logical router have one level for every router you imported from the NV9000 system controller.

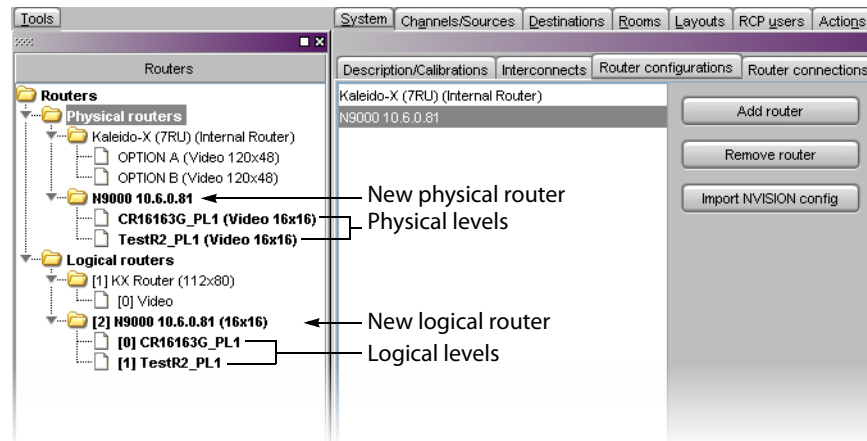

One physical router, and one logical router were added, each with two levels whose names match the names of the corresponding NV9000 physical levels.

If you intend to import other router configurations from the same NV9000 system controller, separately, then you must rename the physical router associated with the configuration you just imported. Otherwise, if you use the **Create one router with multiple levels** option again, then any configuration you import next will replace the current one. See [Renaming Physical Routers](#) below.

- 8 On the File menu, click **Save**.
- 9 Click the **Channels/Sources** tab.
- 10 In the filtered System list, right-click the external router you just imported, and then click **Create logical sources** on the menu.

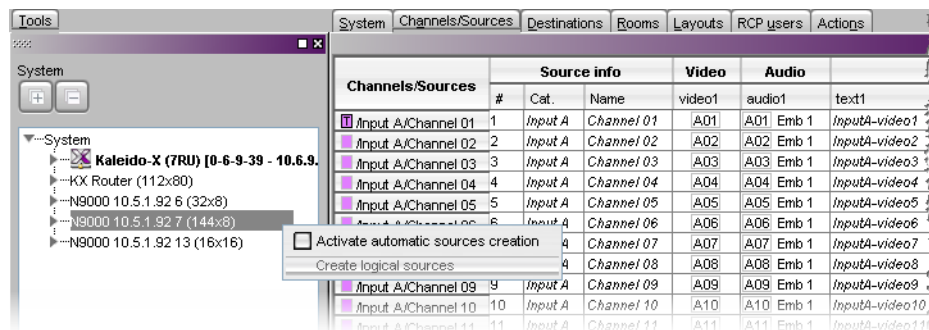

The sources table now includes entries for your router sources.

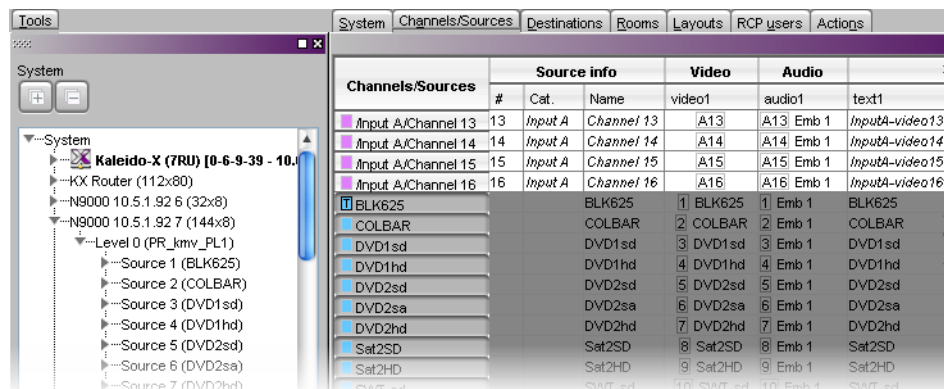

- Sort the sources table as appropriate for your purposes, if you wish, and then define IDs for the new sources, using the incremental copy tool as needed. You may also want to set a category.

System Channels/Sources Destinations Rooms Layouts RCP users Actions							
Channels/Sources	Source info			Video	Audio		
	#	Cat.	Name	video1	audio1	emb1	text1
Input A/Channel 13	13	Input A	Channel 13	A13	A13	Emb 1	InputA-video13
Input A/Channel 14	14	Input A	Channel 14	A14	A14	Emb 1	InputA-video14
Input A/Channel 15	15	Input A	Channel 15	A15	A15	Emb 1	InputA-video15
Input A/Channel 16	16	Input A	Channel 16	A16	A16	Emb 1	InputA-video16
KMV92/BLK625	17	KMV92	BLK625	1 BLK625	1	Emb 1	BLK625
KMV92/COLBAR	18	KMV92	COLBAR	2 COLBAR	2	Emb 1	COLBAR
KMV92/DVD1sd	19	KMV92	DVD1sd	3 DVD1sd	3	Emb 1	DVD1sd
KMV92/DVD1hd	20	KMV92	DVD1hd	4 DVD1hd	4	Emb 1	DVD1hd
KMV92/DVD2sd	21	KMV92	DVD2sd	5 DVD2sd	5	Emb 1	DVD2sd
KMV92/DVD2sa	22	KMV92	DVD2sa	6 DVD2sa	6	Emb 1	DVD2sa
KMV92/DVD2hd	23	KMV92	DVD2hd	7 DVD2hd	7	Emb 1	DVD2hd
KMV92/Sat2SD	24	KMV92	Sat2SD	8 Sat2SD	8	Emb 1	Sat2SD

Source IDs →      ← Category

**Note:** If this router is subject to frequent dimension changes, then you may want to select **Activate automatic sources creation** (see [step 10](#)). When the router is reconfigured with larger dimensions in NV9000-SE Utilities, you will need to import the router configuration from the NV9000 again, but the appropriate number of sources will be automatically added to the sources table, at the same time, with their assignments based on the current template (see [Defining Physical Assignments](#), on page 185). On the other hand, if the number of sources for this router becomes smaller, then you will need to delete the unnecessary entries from the sources table manually.

Channels/Sources	Source info			Video	Audio		
	#	Cat.	Name	video1	audio1	emb1	text1
KMV92/EVsrc3	179	KMV92	EVsrc3	83 EVsrc3	83	Emb 1	EVsrc3
KMV92/EVsrc4	180	KMV92	EVsrc4	84 EVsrc4	84	Emb 1	EVsrc4
KMV92/INP 85	181	KMV92	INP 85	85 INP 85	85	Emb 1	INP 85
KMV92/INP 86	182	KMV92	INP 86	86 INP 86	86	Emb 1	INP 86
KMV92/INP 87			Add source		87	Emb 1	INP 87
KMV92/INP 88			Delete selected sources		88	Emb 1	INP 88
KMV92/INP 89			Set source as template		89	Emb 1	INP 89
KMV92/INP 90			Apply template to all sources		90	Emb 1	INP 90
KMV92/INP 91			Apply template to selected sources		91	Emb 1	INP 91
KMV92/INP 92					92	Emb 1	INP 92
KMV92/INP 93	189	KMV92	INP 93	93 INP 93	93	Emb 1	INP 93
KMV92/INP 94	190	KMV92	INP 94	94 INP 94	94	Emb 1	INP 94
KMV92/INP 95	191	KMV92	INP 95	95 INP 95	95	Emb 1	INP 95

- On the **File** menu, click **Save**, and then click the **Destinations** tab.
- In the **Destinations** tab, adjust the number of destinations if you wish, by typing the desired number in the **Size** box, and then click **Auto map** if needed to configure all *KX Router* destinations as monitor wall destinations.
- Click the **System** tab, and then click **Router connections** on the second-level tab bar.
- Specify the appropriate physical connections between your multiviewer inputs and the external router outputs that feed them. See [Router Connections](#) on page 371, for details.

Description/Calibrations		Interconnects	Router configurations	Router connections
Inputs	Router outputs			
	Router	Port		
INPUT A - Video 01 ←	N9000 10.5.1.92 7 - PR_kmv_PL1	Output 1 [MGALL1]		
INPUT A - Video 02 ←	N9000 10.5.1.92 7 - PR_kmv_PL1	Output 2 [MGALL2]		
INPUT A - Video 03 ←	N9000 10.5.1.92 7 - PR_kmv_PL1	Output 3 [MGALL3]		
INPUT A - Video 04 ←	Unconnected	---		
INPUT A - Video 05 ←	Unconnected	---		
INPUT A - Video 06 ←	Unconnected	---		

- 16 Click the **Layouts** tab.
- 17 Open the layout you wish to use, and then assign monitor wall destinations to monitors in your layout, as required. See [Assigning Logical Sources or Monitor Wall Destinations to Monitors](#) on page 232 for details.  
You may also assign a logical source to each monitor, if you wish.
- 18 For every monitor to be used as a monitor wall destination, specify the appropriate text level, based on the information you wish the UMDs to display. See [Configuring Dynamic UMD Text](#) on page 272, for details.
- 19 On the **File** menu, click **Save**, and then click the **LOAD** button on the toolbar.  
The layout appears on the monitor wall.

## Renaming Physical Routers

### To rename a physical router

- 1 In the Routers list, click the physical router you wish to rename.

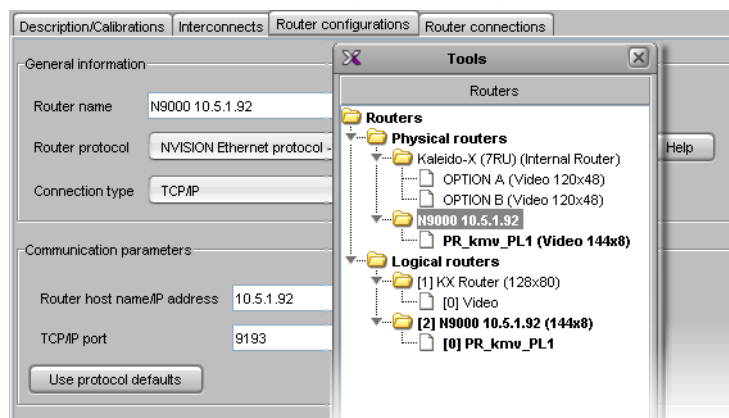

- 2 In the **Router configuration** tab, type the new name in the **Router name** box, and then press Enter.  
You may rename the associated logical router, for consistency.

## Configuring an External Router

The process of creating and configuring an external router (e.g. a third-party router or router control panel) for use with your Kaleido-X system consists of 4 steps:

- defining the physical router
- adding one or more physical levels
- creating one or more logical routers
- adding one or more logical levels

## Step 1 – Defining a Physical Router

### To configure an external router

- 1 Open XEdit and load the database associated with the multiviewer for which you wish to configure an external router.
- 2 Drag **External Router** from the **Equipment** library onto the root of the System hierarchical list in the **Description/Calibrations** pane.

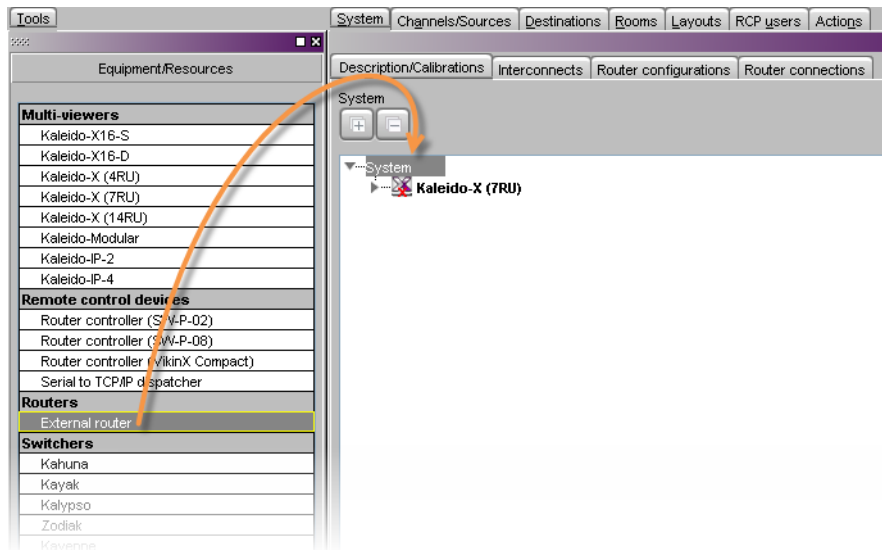

- 3 Enter a descriptive name to act as a device identifier for the external (physical) router.

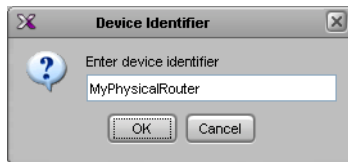

A new physical router appears in the System list.



- 4 Click the **Interconnects** tab, draw a line between the multiviewer and the External Router icons to establish a connection (i.e. add a connection properties entry to the database), and then click the line.

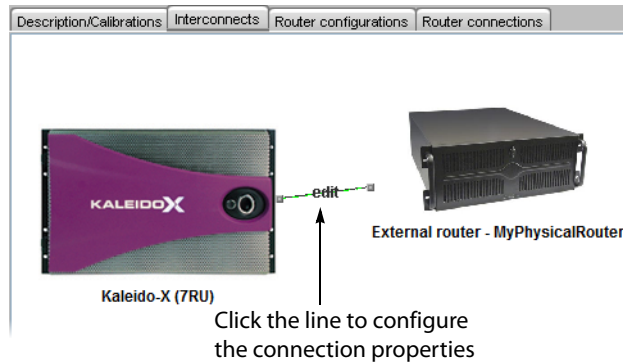

- 5 In the **Properties** pane, select the appropriate element from the **Connect to** list. This can be a serial connection, or a network (TCP/IP or UDP/IP) connection.

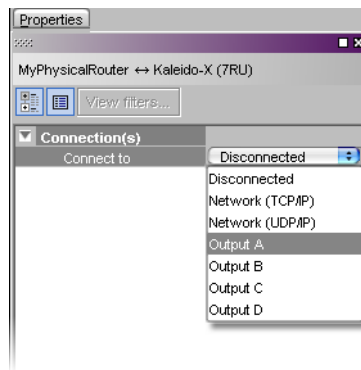

Depending on the multiviewer model (e.g., on a Kaleido-X, each output card has one RS-422 port, a Kaleido-X16 has one or two RS-422 ports), the available RS-422 ports are designated as follows:

KMV-3901/3911	RS-422
Kaleido-X16	Port 1, and Port 2
Kaleido-X (14RU)	Frame A – Output A, B, and C; Frame B – Output A, B, and C
Kaleido-X (7RU)	Output A, B, C, and D
Kaleido-X (4RU)	Output A, and B
Kaleido-MX	Output A, and B Note: The Kaleido-MX (1RU) 16×4 model has only one RS-422 port, which is physically connected to output card A.
Kaleido-Modular-X	Output A, and B Note: KMX-3901-OUT output cards with a single rear connector panel (KMX-3901-OUT-D-3+SRP) do not have RS-422 ports. To support a serial device, your Kaleido-Modular-X system must have at least one output card with a double rear connector panel (KMX-3901-OUT-D-3DRP).

At this point, there are still no properties associated with the new physical router.

- 6 Click the **Router configurations** tab.

Notice that, in the **Routers** list, under **Physical routers**, XEdit has added the new physical router.

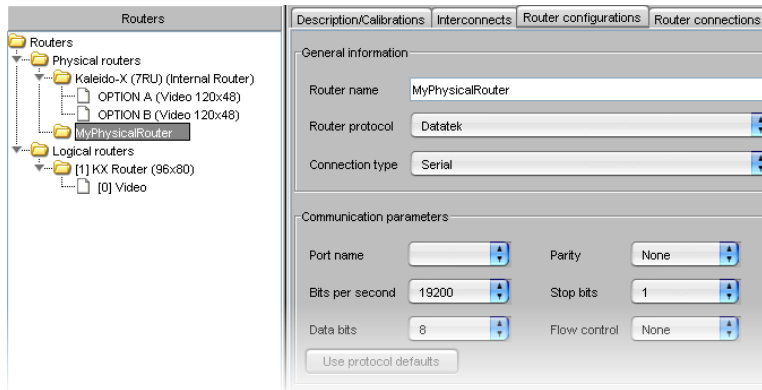

**Note:** A physical router associated with the multiviewer's own internal router module is also predefined. In the case of a multiviewer that does not have any router card, there will be no entries in the **Levels** list for this physical router).

#### 7 Select the appropriate protocol in the **Router protocol** list.

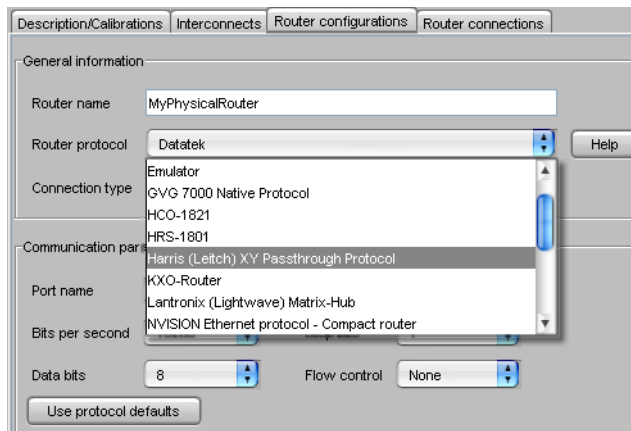

Once you have chosen a protocol, you can click **Help** to view tips on its use.

**Note:** The connection type and serial port specified earlier (see [step 5](#)), if any, appear here automatically. These values can be changed, if necessary. Any changes will also appear in the **Properties** pane.

- In the case of a serial connection, you can specify serial communication parameters: the bit rate (bps), the number of data bits, parity, stop bits and flow control.



- If the connection type is **TCP/IP** or **UDP/IP**, you must specify the router's IP address and port number.

- 8 Click **Use protocol defaults** to specify the default parameters for the selected protocol (this can be useful to begin if you do not have access to your specific router's documentation).

At this point, you have created a new physical router.

## Step 2 – Adding Physical Levels

There is not always just one connection per router. Sometimes, the connection is to one of several routers in a cascade configuration. For example, in the case of Nevion (Network Electronics) VikinX routers, the multiviewer sends commands to one router in the cascade, which passes it on to the other routers via an internal communications mechanism (MIDI in this case). Each router in the cascade has an ID. To represent this arrangement in XEdit, the router connected to the multiviewer is considered the *physical router*, with all of the routers in the cascade represented by a *physical level*.

Even if the multiviewer is connected directly to a router (i.e. no intermediary device), you still use the mechanism of defining a physical level. The distinction here is that there would only be one physical level.

### To add one or more physical levels

- 1 In the **Router configurations** tab, click **Add level**.

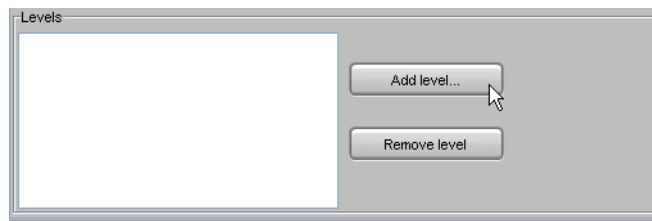

- 2 In the **Physical Level Configuration** window, type a name in the **Level name** box (e.g. "Video").

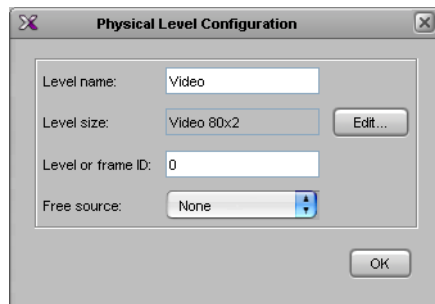

- 3 Type the appropriate value in the **Level or frame ID** box (whether a *level ID* or a *frame ID* is relevant depends on the protocol in use).

---

**Note:** This value identifies and must match the ID of the physical router in a cascade (there is sometimes a jumper on the router that is used to set its ID, or it may be done by changing a configuration setting using software that comes with the router). The Kaleido-X software uses this ID to issue a command via the serial port (e.g. "Change this crosspoint on router ID 2"). When the command is sent to routers on a MIDI bus, each router will examine the command, check its ID, and ignore it unless the ID matches its own.

---

- 4 Click **Edit**.
- 5 In the **Edit Level Size** window, type the appropriate number of sources and destinations for this physical router.

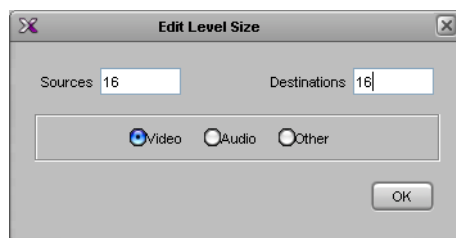

---

**Note:** The three option buttons labeled **Video**, **Audio** and **Other** are used for Nevion (Network Electronics) routers only, for which levels must be classified as either **Video** or **Audio**. These settings are ignored by routers from other manufacturers.

---

- 6 Click **OK**, and then click **OK** again in the **Physical Level Configuration** window.

At this point, you have added a level to a physical router, which appears in the **Levels** list under the **Router configurations** tab, and in the **Routers** list in the **Tools** pane.

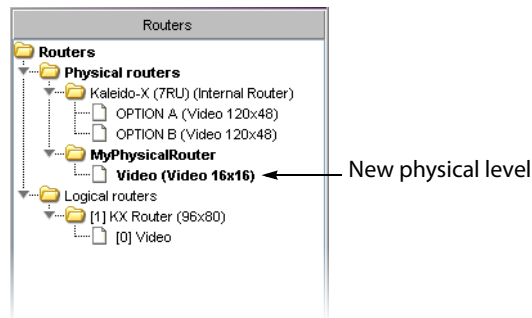

For example, if the physical router is a controller talking to a cascade of routers using a specified protocol, you might have defined one of these, a video router, as Level 0 in the cascade, with 16 sources and 16 destinations (16 × 16).

- You can continue to add levels for other routers in the cascade. The screens below, for example, show how to define a 32 × 32 level for a Nevion (Network Electronics) audio router.

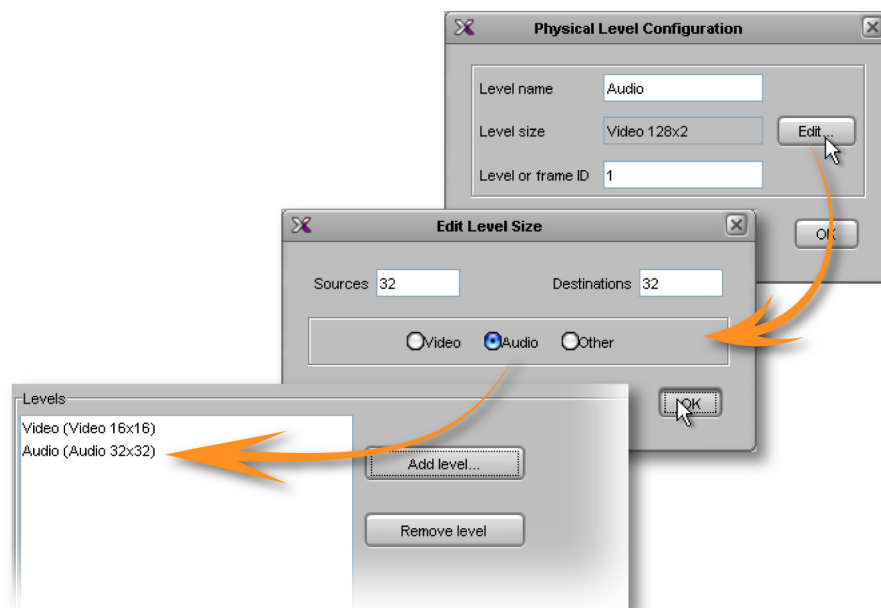

It is fairly typical to have an audio and a video router connected to the same serial port. When a crosspoint switch is sent out over the serial port, it addresses both routers, so that the audio follows the video switch.

### Step 3 – Adding Logical Routers

Logical routers add another layer of refinement over the control of a router. In a typical situation, a very large router (e.g. 1024 × 1024) might be used to control a TV station. The station manager does not want just anyone to be able to change any source to any destination, because some of these destinations go straight to air. If someone accidentally changes a crosspoint on the monitor wall, and the feed goes live, the error could have

serious consequences. To avoid such problems, it is desirable to give operators access only to those crosspoints they need, by creating logical routers.

### To add a logical router

- 1 In the **Routers** list, click the **Logical routers** folder, and then click **Add router** under the **Router configurations** tab.

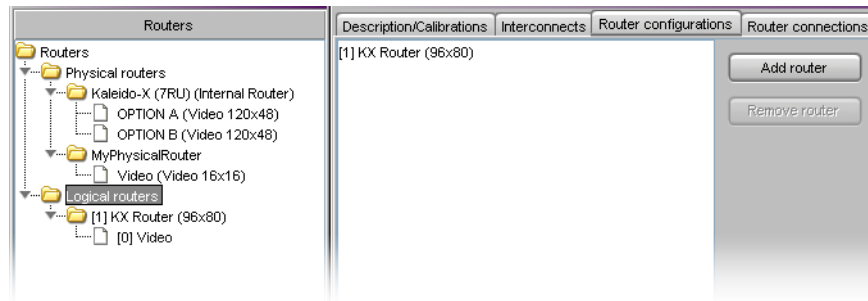

A new sub-folder is added to the **Logical routers** folder. This new folder is automatically selected, and a third-level tab bar appears under **Router configurations**, with the **Configuration** tab selected.

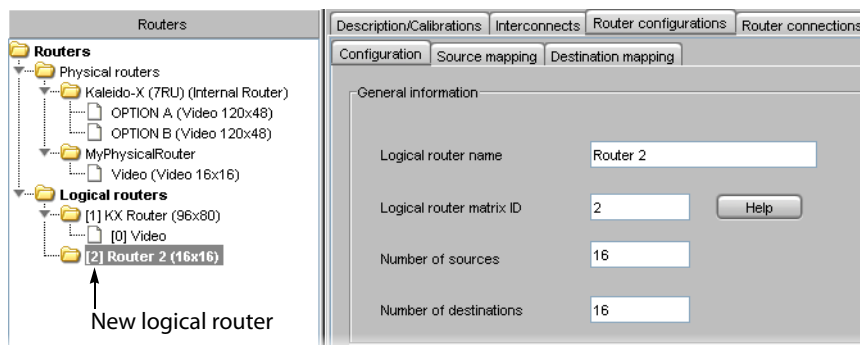

- 2 Type a name (e.g. "SmallLogicalRouter") in the **Logical router name** box. This is the name that will appear on monitor wall in the **Assign [router] input** menu. Ignore the **Logical router matrix ID** box for now. Type the desired number of sources and destinations (e.g. 16 × 4).

---

**Note:** In the case of a multiviewer systems configured with an upstream router that has more than 288 sources, the **Assign [router] input** menu is not available, and you must manage the router's physical sources as logical sources within the multiviewer system (see [Logical source](#), on page 177). Router sources can thus be assigned to monitor wall elements transparently, just as sources connected directly to the multiviewer's inputs (see [Assigning Sources to Monitors](#), on page 51).

---

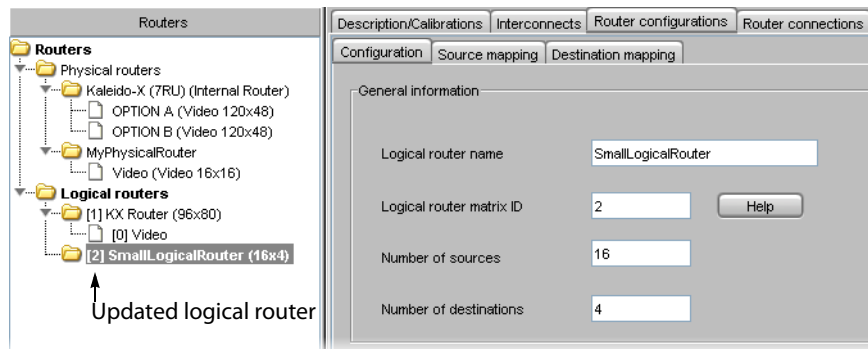

The subfolder that represents the new logical router is renamed automatically, reflecting your changes.

#### IMPORTANT

**Once you have configured the logical router, it is important not to change its name.**

Doing so will disable any settings that refer to the existing router name, including:

- logical source assignments for source or destination label,
- external router connection configurations,
- monitors and background actions associated with the logical router,
- automatic crosspoint changes on video monitors (router source property).

If you change the name back to the original, everything should work as before.

- 3 Click **Add level**.
- 4 In the **Logical Level Configuration** window, type a **Logical level name** (e.g. "Video"). The **Logical level ID** is not important at this point.

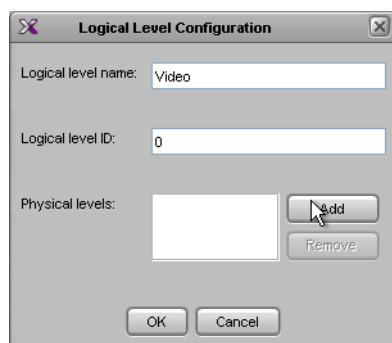

- 5 The logical level must be associated with a physical router level. Click **Add**, and then select the appropriate physical level from the list that appears.

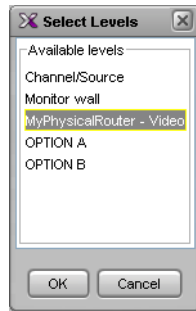

- 6 Click **OK**, and then click **OK** again in the **Logical Level Configuration** window. The new logical level appears in the **Levels** list, and also under the new sub-folder that represents the logical router in the **Routers** list.

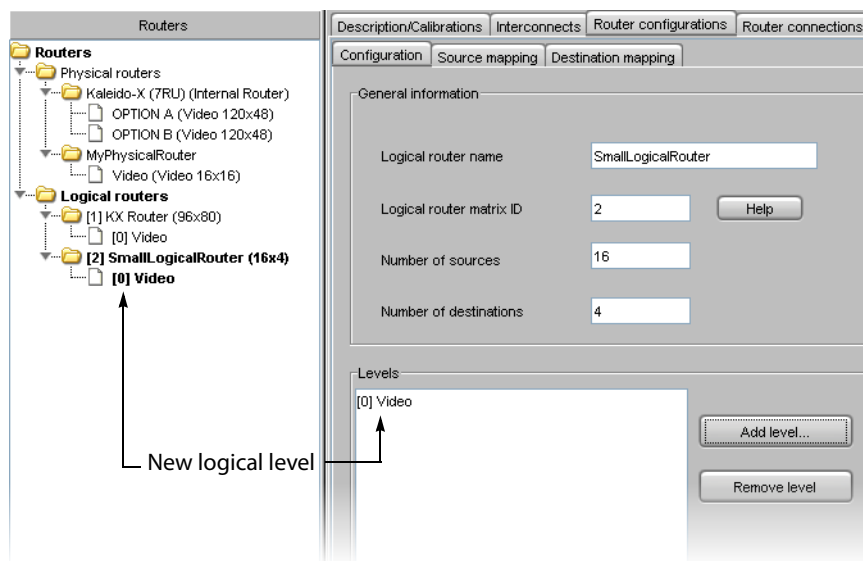

Next, you must specify the relationship between the logical level destinations (4 in this example) and the physical destinations (16 in this example).

- 7 Click the **Destination mapping** tab.

The **Destination mapping** table includes rows for each of the logical destinations (4 in this example), with columns for entering a text label (e.g. “Main Out”, “Preview”, etc.) and the corresponding physical router destination (this column’s heading corresponds to the logical router level specified earlier– “[0] Video” in this example).

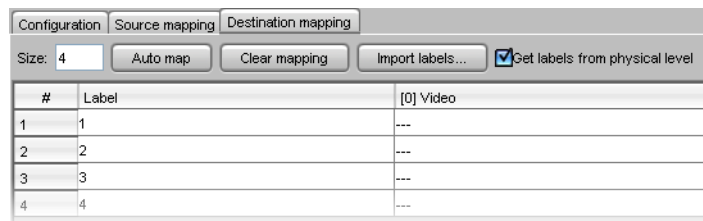

- 8 Click in a row in the physical level column.

A menu appears listing all of the available outputs associated with that physical level.

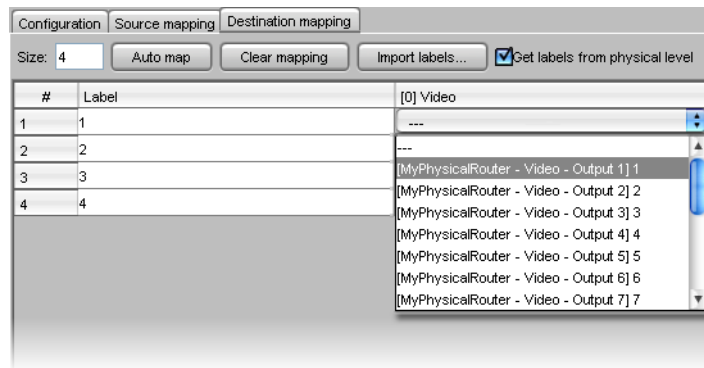

- 9 Choose a physical output for this logical destination, and then proceed in the same fashion for the other destinations, or click **Auto map** to automatically enter physical outputs, in sequential order, starting from the first one in the list.

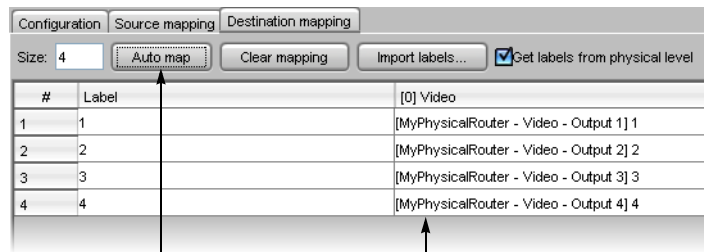

Auto map button Physical outputs are automatically populated

- If you have already specified a physical output, the sequence starts from that one, then autofills from there.
- If the one you specified is in a row part way down the table, auto-mapping fills in the rows below, then continues the sequence starting at the top of the table.

This feature is particularly useful when mapping a large number of destinations.

**Note:** If you make a mistake, click **Clear mapping**, and then click **Yes** in the confirmation message that appears to delete the entries in the physical output column of the table. This does not affect the **Labels** column.

- 10 To import labels from a CSV file (i.e. a comma-delimited file such as might be exported from an Excel spreadsheet), click **Import labels**, navigate to the CSV file that contains the labels you wish to import, select it, and then click **Open**.

**Note:** The file must be formatted as three columns with no heading row. Column 1 should contain numbers from 1 to N (the number of sources), column 2 should contain the source labels, and column 3 should contain the destination labels. Columns are delimited by commas, without spaces.

Sample label file:

```
1,VTR 1,OUT 1
2,VTR 2,OUT 2
3,CAM 1,OUT 3
4,CAM 2,OUT 4
5,SAT 1,PGM
6,SAT 2,PVW
```

Alternatively, select the **Get labels from physical level** check box, to import labels directly from a router at runtime.

**Note:** Labels are imported at runtime (i.e. they only appear on the monitor wall, not in XEdit). This feature applies to the following router protocols only:

- ETL Matrix
- Evertz Quartz Type 1
- HRS-1801
- NVISION Ethernet protocol - Enterprise router
- Snell (Pro-Bel) General Remote Control Protocol (SW-P-08)
- Thomson / Grass Valley GVG 7000 Native Protocol
- Utah Scientific RCP-3 Protocol

The list of supported protocols appears at the bottom of the **Source mapping** and **Destination mapping** tabs.

As with destinations, the sources of the logical level must be associated with sources on the physical router.

- 11 Click the **Source mapping** tab. The table works in the same way as for destinations, except that the number of rows is determined by the number of sources specified when the logical level was created.

**Auto mapping example:** Specify Input 4 in Row 2, then click **Auto map**. The auto mapper starts by putting Input 1 in Row 1, detects the entry in Row 2, so picks up the sequence by putting Input 5 in Row 3, Input 6 in Row 4, etc.

#	Label	[0] Video
1	1	[MyPhysicalRouter - Video - Input 1] 1
2	2	[MyPhysicalRouter - Video - Input 4] 4
3	3	[MyPhysicalRouter - Video - Input 5] 5
4	4	[MyPhysicalRouter - Video - Input 6] 6
5	5	[MyPhysicalRouter - Video - Input 7] 7
6	6	[MyPhysicalRouter - Video - Input 8] 8
7	7	[MyPhysicalRouter - Video - Input 9] 9
8	8	[MyPhysicalRouter - Video - Input 10] 10
9	9	[MyPhysicalRouter - Video - Input 11] 11
10	10	[MyPhysicalRouter - Video - Input 12] 12
11	11	[MyPhysicalRouter - Video - Input 13] 13
12	12	[MyPhysicalRouter - Video - Input 14] 14
13	13	[MyPhysicalRouter - Video - Input 15] 15
14	14	[MyPhysicalRouter - Video - Input 16] 16
15	15	[MyPhysicalRouter - Video - Input 2] 2
16	16	[MyPhysicalRouter - Video - Input 3] 3

#### IMPORTANT

You can have the same physical sources and destinations mapped to multiple logical routers. The software does not prevent this. In the case of destinations, care must be taken to avoid conflicts when using auto mapping.



At this point, you have completed the source and destination mapping for a logical level (e.g. "[0] Video"). Additional levels can be created. For example, it is often necessary to switch the audio at the same time as the video. If you have a video router and an audio router, and you select Video 2 on the former, you probably want the associated audio to switch as well. To accomplish this, define a new logical level for the audio.

- 12 Create a new logical level (e.g. "[1] Audio"), and associate it with a physical router Audio level.

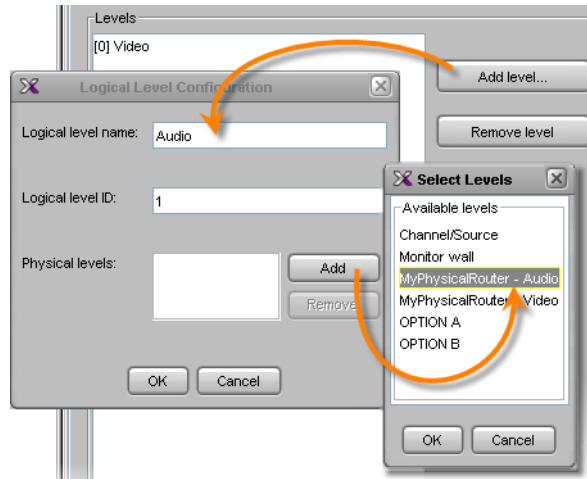

The new level appears under the logical router in the Routers list.

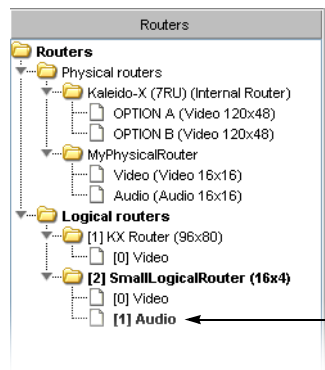

- 13 Click the **Destination mapping** tab.

A new column appears, corresponding to the new logical Audio level. The audio destinations can be mapped to correspond to the video destinations. Use the **Auto map** button as needed.

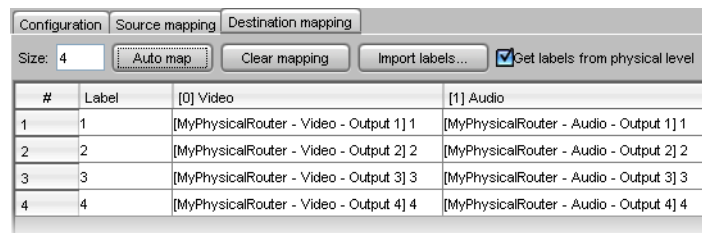

- 14 Proceed in the same fashion with the source mapping.

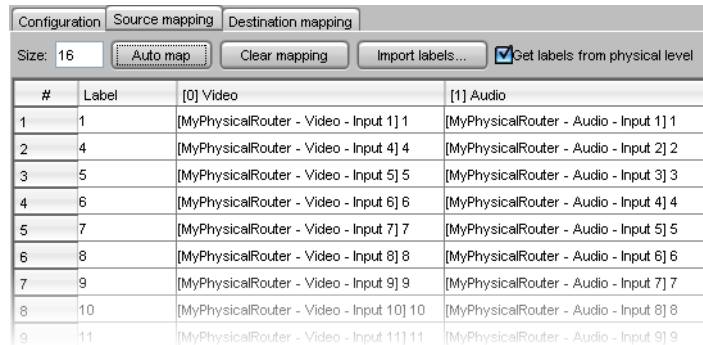

The screenshot shows a configuration window with tabs for 'Configuration', 'Source mapping', and 'Destination mapping'. Below the tabs are buttons for 'Auto map', 'Clear mapping', and 'Import labels...', along with a checked checkbox for 'Get labels from physical level'. A table below displays the mapping between video and audio inputs.

#	Label	[0] Video	[1] Audio
1	1	[MyPhysicalRouter - Video - Input 1] 1	[MyPhysicalRouter - Audio - Input 1] 1
2	4	[MyPhysicalRouter - Video - Input 4] 4	[MyPhysicalRouter - Audio - Input 2] 2
3	5	[MyPhysicalRouter - Video - Input 5] 5	[MyPhysicalRouter - Audio - Input 3] 3
4	6	[MyPhysicalRouter - Video - Input 6] 6	[MyPhysicalRouter - Audio - Input 4] 4
5	7	[MyPhysicalRouter - Video - Input 7] 7	[MyPhysicalRouter - Audio - Input 5] 5
6	8	[MyPhysicalRouter - Video - Input 8] 8	[MyPhysicalRouter - Audio - Input 6] 6
7	9	[MyPhysicalRouter - Video - Input 9] 9	[MyPhysicalRouter - Audio - Input 7] 7
8	10	[MyPhysicalRouter - Video - Input 10] 10	[MyPhysicalRouter - Audio - Input 8] 8
9	11	[MyPhysicalRouter - Video - Input 11] 11	[MyPhysicalRouter - Audio - Input 9] 9

If the audio mapping mirrors the video mapping, then, when a video switch is made (e.g. from Video 1 to Video 2), the corresponding audio will follow (i.e. the same command will switch a crosspoint in both the physical video router and the physical audio router).

---

**Note:** Grass Valley's Router Control Software includes applications for controlling routers (single bus and matrix) where you can operate in *all follow* mode (change all levels), or in *breakaway* mode.<sup>1</sup> When you make a crosspoint change in a logical router, you can change all of the logical levels, or just specific ones. **When controlling the monitor wall, only the "all follow" mode is supported.** If you need to set up breakaway switches, you must use other software—e.g. Grass Valley's Router Control Software—, or a router controller—e.g. a device that supports the Snell (Pro-Bel) SW-P-08 protocol.

---

1. The *all follow* mode is more typically used. An example of a breakaway would be switching Video 4 with Audio 5 instead of Audio 4 because Audio 5 is in another language.

At this point, you have completed the definition of an external router.

## Configuring a Router Controller

There are two categories of router controllers that can be used to control the routers connected to (controlled by) a multiviewer:

- Simple router controllers, such as the Nevion (Network Electronics) VikinX Compact, or devices that support the Snell (Pro-Bel) SW-P-02 protocol.
- Intelligent router controllers that support the Snell (Pro-Bel) SW-P-08 protocol.

### Adding a Simple Router Controller

A VikinX Compact router controller, on any control panel that supports the Snell (Pro-Bel) SW-P-02 protocol, can issue switching commands to a specific router connected to (controlled by) the multiviewer, which will act as a *protocol translator*.

## Adding a VikinX Compact router controller

### To add a VikinX Compact (or equivalent) router controller

- 1 Click and drag **Router controller (VikinX Compact)** from the **Equipment** library to the **System** hierarchical list.

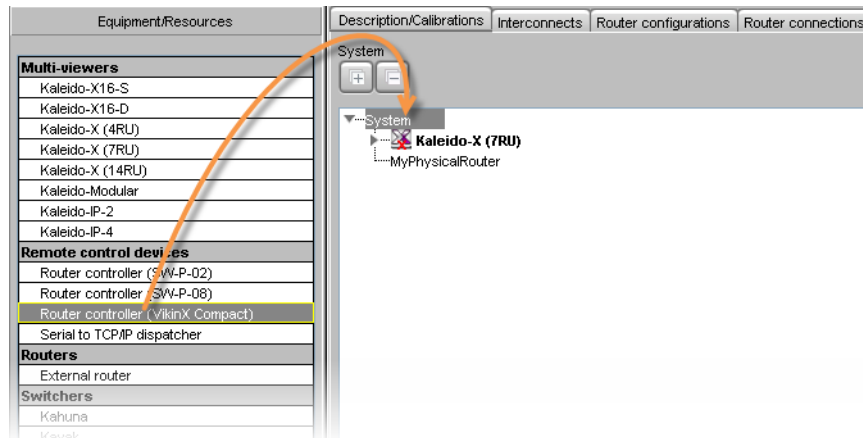

- 2 When prompted, type a name, and then click **OK**.

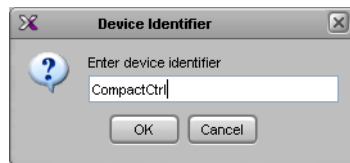

- 3 Click the **Interconnects** tab, draw a line between the multiviewer and the new router controller, and then click the line.

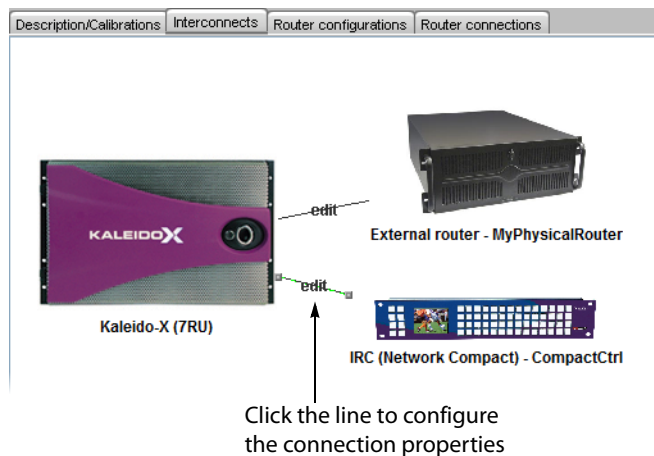

- 4 In the **Properties** pane, select the appropriate element from the **RS-422 communication port** list.

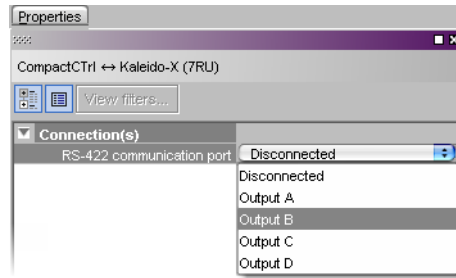

Depending on the multiviewer model, the available RS-422 ports are designated as follows:

KMV-3901/3911	RS-422
Kaleido-X16	Port 1, and Port 2
Kaleido-X (14RU)	Frame A – Output A, B, and C; Frame B – Output A, B, and C
Kaleido-X (7RU)	Output A, B, C, and D
Kaleido-X (4RU)	Output A, and B
Kaleido-MX	Output A, and B Note: The Kaleido-MX (1RU) 16 × 4 model has only one RS-422 port, which is physically connected to output card A.
Kaleido-Modular-X	Output A, and B Note: KMX-3901-OUT output cards with a single rear connector panel (KMX-3901-OUT-D-3+SRP) do not have RS-422 ports. To support a serial device, your Kaleido-Modular-X system must have at least one output card with a double rear connector panel (KMX-3901-OUT-D-3DRP).

**Note:** Simple router controllers can also communicate with Kaleido-X via TCP/IP. This type of connection is enabled automatically, and allows such controllers to issue commands to the multiviewer’s internal router module.

- 5 In the **Interconnects** tab, click the router controller icon.

In the **Properties** pane, a list of settings appears, with default values for the serial communication parameters: the bit rate (bps), the number of data bits, parity, stop bits and flow control.

- 6 Select a logical router (e.g. SmallLogicalRouter) from the **Router** list.

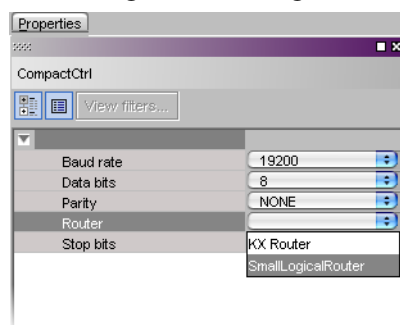

This is the logical router that will be controlled by the router control panel. When the multiviewer receives commands over the serial port on the output card selected in [step 4](#), it will know these are destined for the logical router corresponding to "SmallLogicalRouter".

**Note:** The VikinX Compact protocol allows you to specify one logical router only (it is a one-to-one controller protocol).

### Adding a Snell (Pro-Bel) SW-P-02 router controller

#### To add a control panel that uses the SW-P-02 protocol

- Refer to procedure above but, at [step 1](#), select **Router controller (SW-P-02)** from the Equipment library instead of **Router controller (VikinX Compact)**.

### Adding an Intelligent Router Controller

An intelligent router controller is one that can issue switching commands to any router connected to (controlled by) the multiviewer. In order to be able to do this, it must attach a unique identifier to each command that will allow the Kaleido-X software to direct the command to the appropriate device. This unique identifier is the "Logical router matrix ID", which is similar to the "Level or frame ID" for a physical router, but identifies a logical router.

So, for example, if you press a button on the external panel that is set up to make a crosspoint change on logical router matrix ID 0, the Kaleido-X software will receive this command, look up matrix ID 0 to find the physical router it is mapped to, and then forward the crosspoint change to the physical router using the appropriate protocol. In such cases, the Kaleido-X software acts as a "protocol translator" for the control panel.

#### To add a Snell (Pro-Bel) SW-P-08 (or equivalent) router controller

- Click and drag **Router controller (SW-P-08)** from the **Equipment** library to the System hierarchical list.

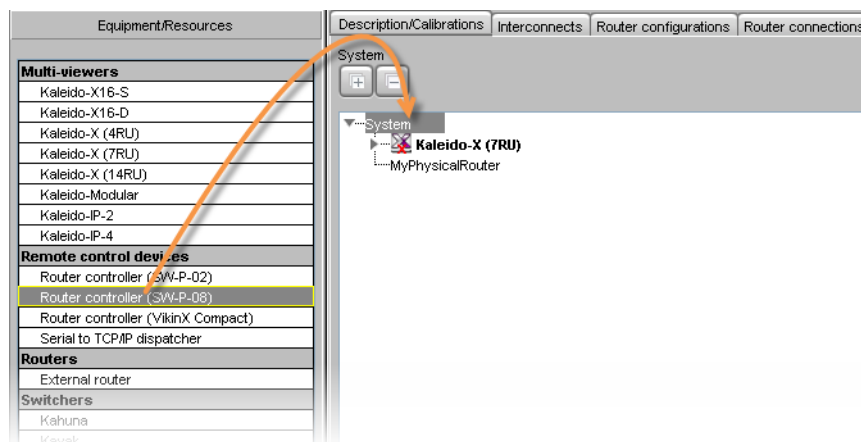

- When prompted, type a name for the router controller, and then click **OK**.

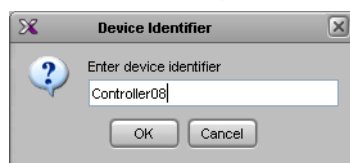

- Click the **Interconnects** tab, draw a line between the multiviewer and the new router controller, and then click the line.

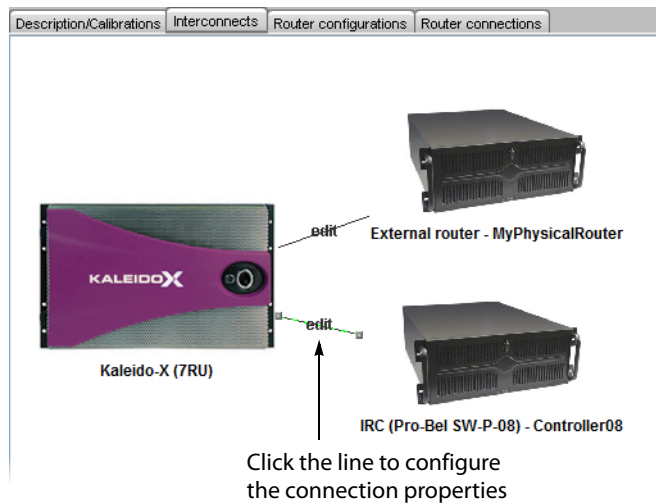

- In the **Properties** pane, select the appropriate element from the **RS-422 communication port** list.

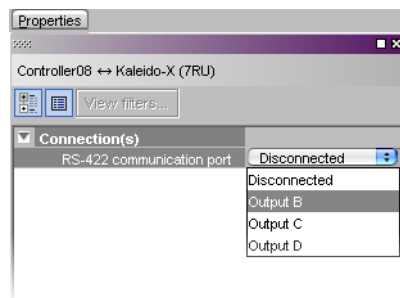

Depending on the multiviewer model, the available RS-422 ports are designated as follows:

KMV-3901/3911	RS-422
Kaleido-X16	Port 1, and Port 2
Kaleido-X (14RU)	Frame A – Output A, B, and C; Frame B – Output A, B, and C
Kaleido-X (7RU)	Output A, B, C, and D
Kaleido-X (4RU)	Output A, and B
Kaleido-MX	Output A, and B Note: The Kaleido-MX (1RU) 16×4 model has only one RS-422 port, which is physically connected to output card A.
Kaleido-Modular-X	Output A, and B Note: KMX-3901-OUT output cards with a single rear connector panel (KMX-3901-OUT-D-3+SRP) do <i>not</i> have RS-422 ports. To support a serial device, your Kaleido-Modular-X system must have at least one output card with a double rear connector panel (KMX-3901-OUT-D-3DRP).

- In the **Interconnects** tab, click the router controller icon.

In the **Properties** pane, a list of settings appears, with default values for the serial communication parameters: the bit rate (bps), the number of data bits, parity, stop bits and flow control.

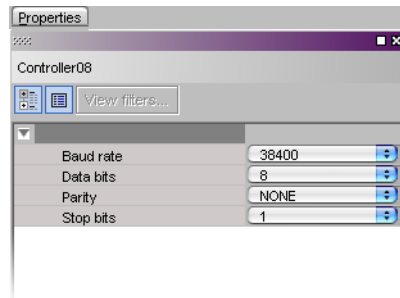

However, in this case, there is no **Router** box for specifying which logical router is to be controlled. This is because the SW-P-08 protocol allows the controller to pass the identifier for the logical router with a command (i.e. it tells the multiviewer to make a crosspoint change for logical router X). The ID that it passes is the logical router matrix ID (refer to [Step 3 – Adding Logical Routers](#), on page 351).

6 Click the **Router configurations** tab to view (or set) the logical matrix ID.

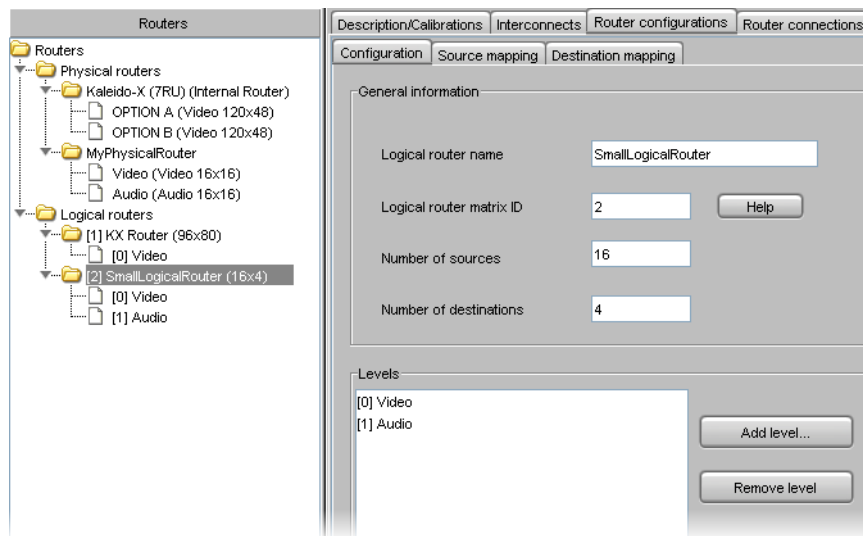

## Notes

- The logical router matrix ID must be manually entered on the Snell (Pro-Bel) controller—this is usually done via a Web interface, but is sometimes done over a serial connection. Some controllers allow you to program individual buttons, or groups of buttons.
- The Snell (Pro-Bel) controller can also use the logical router level IDs (e.g. [0] Video, [1] Audio) when it sends commands, allowing you to target just video crosspoints, just audio crosspoints, or both.

## IMPORTANT

You must always configure a logical router for a physical external router. There is no way to control a physical external router directly.

## Configuring a Multiviewer's Internal Router

To control your multiviewer's internal router, it must be configured in the context of the *KX Router* logical router.

### Configuring the Internal Router in a Kaleido-X16

To configure a Kaleido-X16 multiviewer's internal router

- 1 Click the **Router configurations** tab, and then navigate to the **Kaleido-X16-D (Internal Router)** or **Kaleido-X16-S (Internal Router)** folder under **Physical routers**, in the **Routers** list.

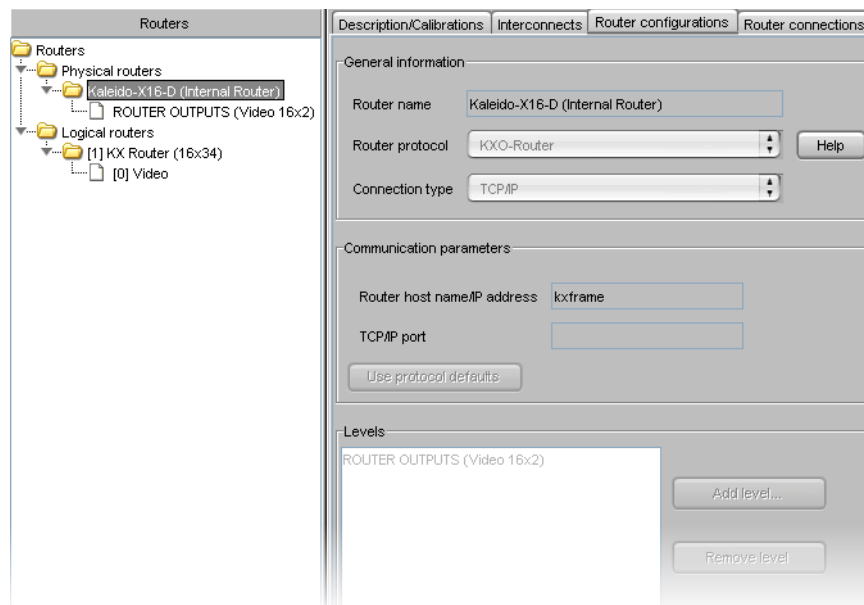

The router protocol, connection type, host name and levels are predefined (and cannot be modified). Under **Kaleido-X16-D (or S) (Internal Router)**, the physical level **ROUTER OUTPUTS (Video 16 × 2)** or **ROUTER OUTPUTS (Video 16 × 1)** was automatically created and configured to the right size.

#### Notes

- The following ports are always active and can be used for controlling a Kaleido-X over TCP/IP, via the associated protocols:
  - port 14000 (SW-P-08)
  - port 2000 (SW-P-02)
  - port 4381 (VikinX Modular)
  - port 5194 (NVISION Ethernet protocol - Compact router)
- When controlling a multiviewer, by using one of the TCP/IP router protocols, the router level to be controlled must be configured in XEdit (see [step 6](#) under [Creating a Single Multiviewer System](#), on page 84). No other communication configuration is required in XEdit.

- 2 Navigate to the **KX Router** folder, under **Logical routers**, and then click the **[0] Video** level.



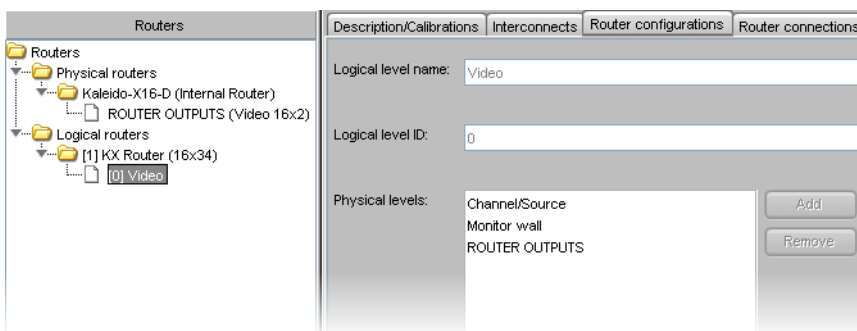

In a factory-default configuration, the physical level **ROUTER OUTPUTS** is automatically included in the KX Router logical level **[0] Video**.

### IMPORTANT

Controlling the multiviewer's internal router by using any other logical router than *KX Router* is not supported. The **ROUTER OUTPUT** physical level must be added to the *first level* (i.e. **[0] Video**), under KX Router.

- 3 If the physical level is not included—for example, someone may have removed it from your configuration—, then you must add it to this logical level. In the **Router configurations** tab, click **Add**.

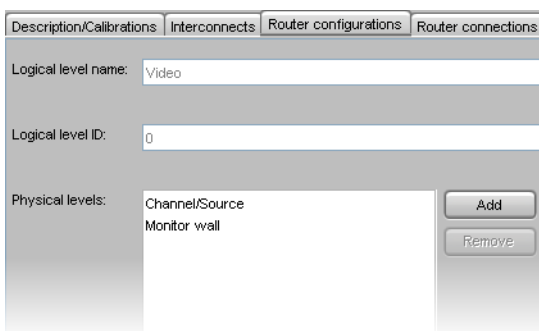

The **Select Levels** window appears, listing all available physical levels.

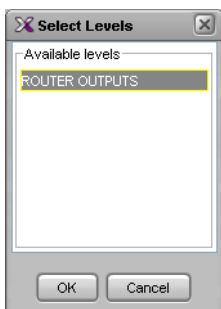

- 4 Select the physical levels you wish to add to KX Router's first logical level, and then click **OK**.

The selected levels appear in the **Physical levels** list.

- 5 Click the **[1] KX Router (16 × 34)** folder under **Logical routers** in the Routers list.

The third-level tab bar appears under **Router configurations**, with the **Configuration** tab selected.

- 6 Source and destination mapping is *not* done automatically. Click the **Source mapping** tab, click a cell in the **[0] Video** logical level column, and then choose an input from the list.
- 7 To import labels from a CSV file (i.e. a comma-delimited file such as might be exported from an Excel spreadsheet), click **Import labels**, navigate to the CSV file that contains the labels you wish to import, select it, and then click **Open**.

---

**Note:** The file must be formatted as three columns with no heading row. Column 1 should contain numbers from 1 to N (the number of sources), column 2 should contain the source labels, and column 3 should contain the destination labels. Columns are delimited by commas, without spaces.

Sample label file:

```
1, VTR 1, OUT 1
2, VTR 2, OUT 2
3, CAM 1, OUT 3
4, CAM 2, OUT 4
5, SAT 1, PGM
6, SAT 2, PVW
```

---

Auto map works as described in [Step 3 – Adding Logical Routers](#) on [page 355](#).

---

**Note:** The **Get labels from physical level** feature is not yet supported for internal router cards.

---

KX Router also has a **Logical router matrix ID**, which can be used by an external router control device or application to control the internal router modules.

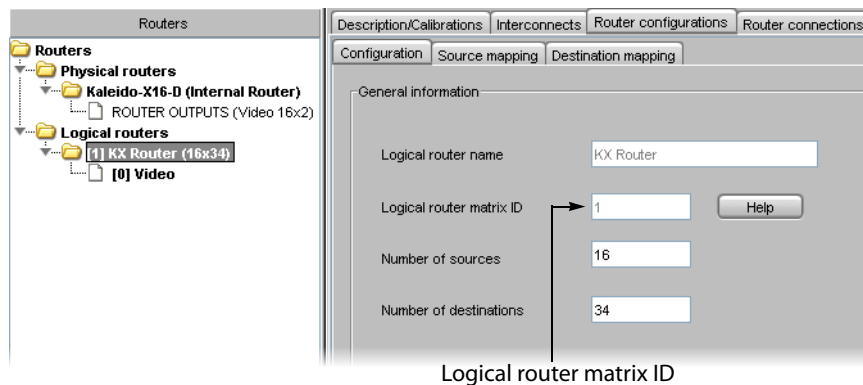

## Configuring the Internal Router in a Kaleido-X (7RU)

### To configure a Kaleido-X (7RU) multiviewer's internal router cards

- 1 Make sure that the System list reflects your multiviewer's router card configuration. To add an internal router card, right-click **OPTION A** or **OPTION B** in the System list, and then click **Insert KXO-24Router** on the menu.

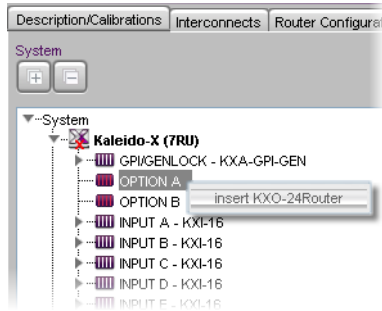

A KXO-24Router card fills the selected slot.

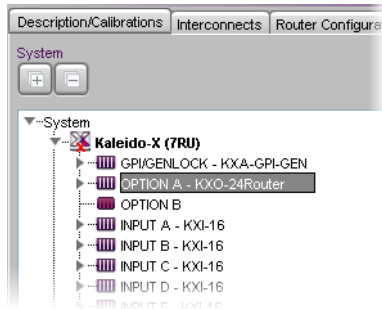

- 2 Click the **Router configurations** tab, and then navigate to the **Kaleido-X (7RU) (Internal Router)** folder under **Physical routers**, in the **Routers** list.

The router protocol, connection type, host name and levels are predefined (and cannot be modified).

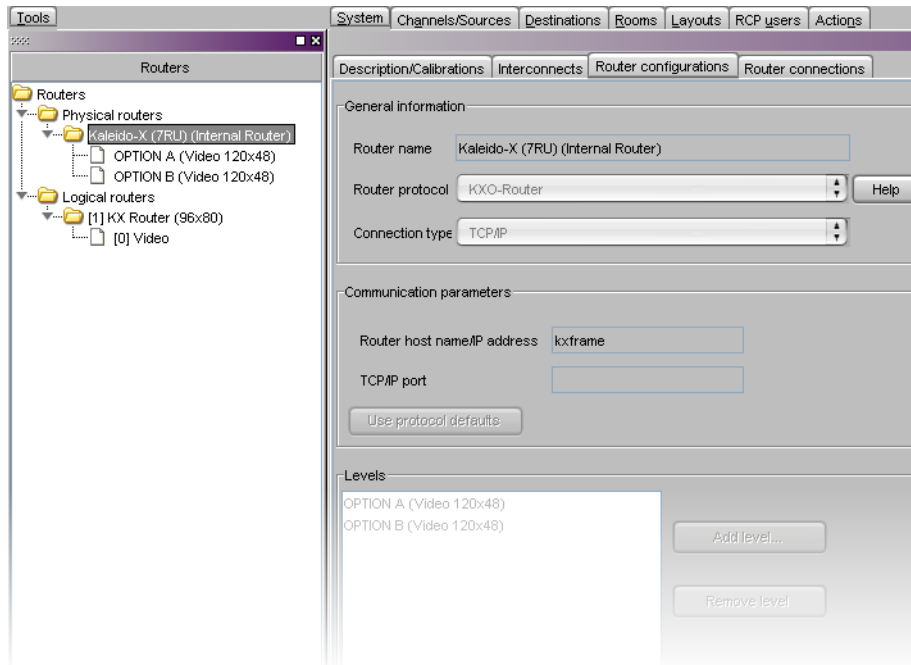

### Notes

- The following ports are always active and can be used for controlling a Kaleido-X over TCP/IP, via the associated protocols:
  - port 14000 (SW-P-08)
  - port 2000 (SW-P-02)
  - port 4381 (VikinX Modular)
  - port 5194 (NVISION Ethernet protocol - Compact router)
- When controlling a multiviewer, by using one of the TCP/IP router protocols, the router level to be controlled must be configured in XEdit (see [step 6](#) under [Creating a Single Multiviewer System](#), on page 84). No other communication configuration is required in XEdit.

- 3 Click **OPTION A** (or **B**) under **Kaleido-X (7RU) (Internal Router)** in the physical routers list. Note that the physical levels are automatically created—OPTION A (Video 120 × 48) and OPTION B (Video 120 × 48)—and configured to the right size.

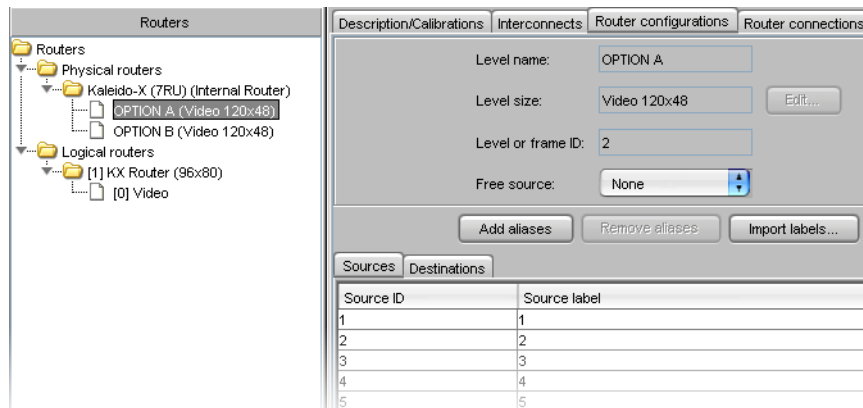

**Note:** “120 × 48” refers to the physical router size including internal connections used for router expansion. The actual size of each router card is 96 × 24. Refer to *Configuring Router Card Expansion* in the Kaleido-X (7RU) Hardware Description & Installation Manual, for more information.

- 4 Navigate to the **KX Router** folder, under **Logical routers**, and then click the **[0] Video** level.

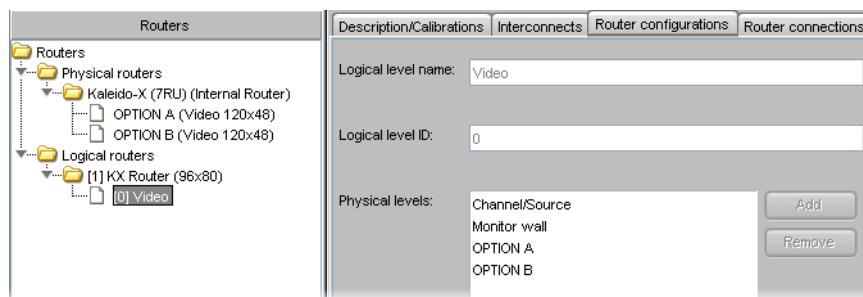

In a factory-default configuration, the physical levels OPTION A and OPTION B are automatically included in the KX Router logical level **[0] Video**. If the physical levels (OPTION A, or B) for your actual router cards are not included—for example, this would

be the case if you just added a router card to your system configuration—, then you must add them to this logical level.

**IMPORTANT**

Controlling the multiviewer's internal router by using any other logical router than *KX Router* is not supported. The physical levels OPTION A and OPTION B must be added to the *first level* (i.e. [0] **Video**), under *KX Router*.

- 5 In the **Router configurations** tab, click **Add**.

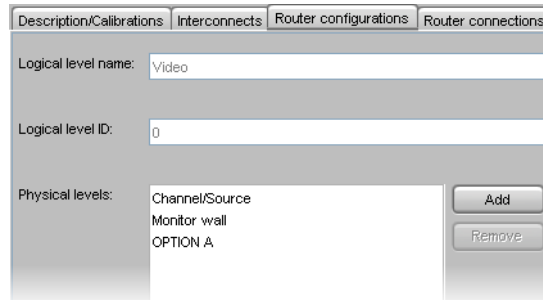

The **Select Levels** window appears, listing all available physical levels.

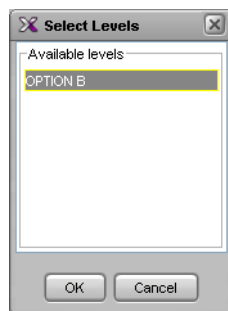

- 6 Select the physical levels you wish to add to KX Router's first logical level, and then click **OK**.

The selected levels appear in the **Physical levels** list.

- 7 Click the [1] **KX Router (96 × 80)** folder under **Logical routers** in the Routers list.

The third-level tab bar appears under **Router configurations**, with the **Configuration** tab selected.

- 8 Source and destination mapping is *not* done automatically. Click the **Source mapping** tab, click a cell in the [0] **Video** logical level column, and then choose an input from the list.

- To import labels from a CSV file (i.e. a comma-delimited file such as might be exported from an Excel spreadsheet), click **Import labels**, navigate to the CSV file that contains the labels you wish to import, select it, and then click **Open**.

---

**Note:** The file must be formatted as three columns with no heading row. Column 1 should contain numbers from 1 to N (the number of sources), column 2 should contain the source labels, and column 3 should contain the destination labels. Columns are delimited by commas, without spaces.

Sample label file:

```
1 , VTR 1 , OUT 1
2 , VTR 2 , OUT 2
3 , CAM 1 , OUT 3
4 , CAM 2 , OUT 4
5 , SAT 1 , PGM
6 , SAT 2 , PVW
```

---

Auto map works as described in [Step 3 – Adding Logical Routers](#) on [page 355](#). It is also useful to have manual control over the source/destination mapping in the event a router card is removed.

---

**Note:** The **Get labels from physical level** feature is not yet supported for internal router cards.

---

KX Router also has a **Logical router matrix ID**, which can be used by an external router control device or application to control the internal router modules.

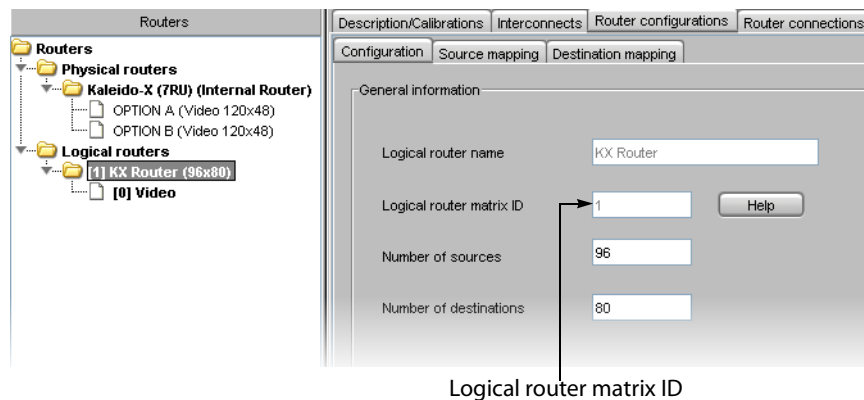

---

**Note:** In the case of a Kaleido-X (7RU), signals entering the input cards are made available to the internal router cards via the midplane (i.e. there is no cabling between the BNC outputs on the router cards and the BNC inputs on the KXI cards).

---

### Configuring the Internal Router in a Kaleido-X (14RU)

Once two Kaleido-X (7RU) systems are in a Kaleido-X (14RU) expansion configuration, thereby giving you access to any source from either frame in your layouts, their respective router cards are not automatically shared between the system's Frame A and Frame B. To be able to choose a source from one frame and send it to a router output on the other frame, you must have connected the router cards of one frame to those of the other using special

cables plugged into the expansion ports on the router cards themselves, and then, in XEdit, you must have specified how the cards are connected. Refer to “Configuring Router Card Expansion” in the Kaleido-X (7RU) Hardware Description & Installation Manual, for details.

## Router Connections

To be able to control an upstream router from the monitor wall, or to control your multiviewer as a router from an external control panel, you must specify physical connections between a number of multiviewer inputs and external router outputs that feed them. This is equivalent to defining the tie lines between two routers: your upstream router and your multiviewer's *KX Router* logical router. When two routers are interconnected, a tie-line manager module allows sources from the upstream router to be routed transparently to the selected destinations. For example, when you want to assign a source from the upstream router to a video monitor on the monitor wall, the Kaleido-X software uses this information to allocate a tie line (i.e. one of the multiviewer's physical input connectors that you reserved for this purpose, and the upstream router's output it is connected to), and initiate the appropriate crosspoint change on the upstream router.

---

**Note:** Tie lines between the multiviewer and an upstream router are meant to be used *exclusively* by the Kaleido-X software. You must not enable features such as destination lock at the router end of a tie line.

---

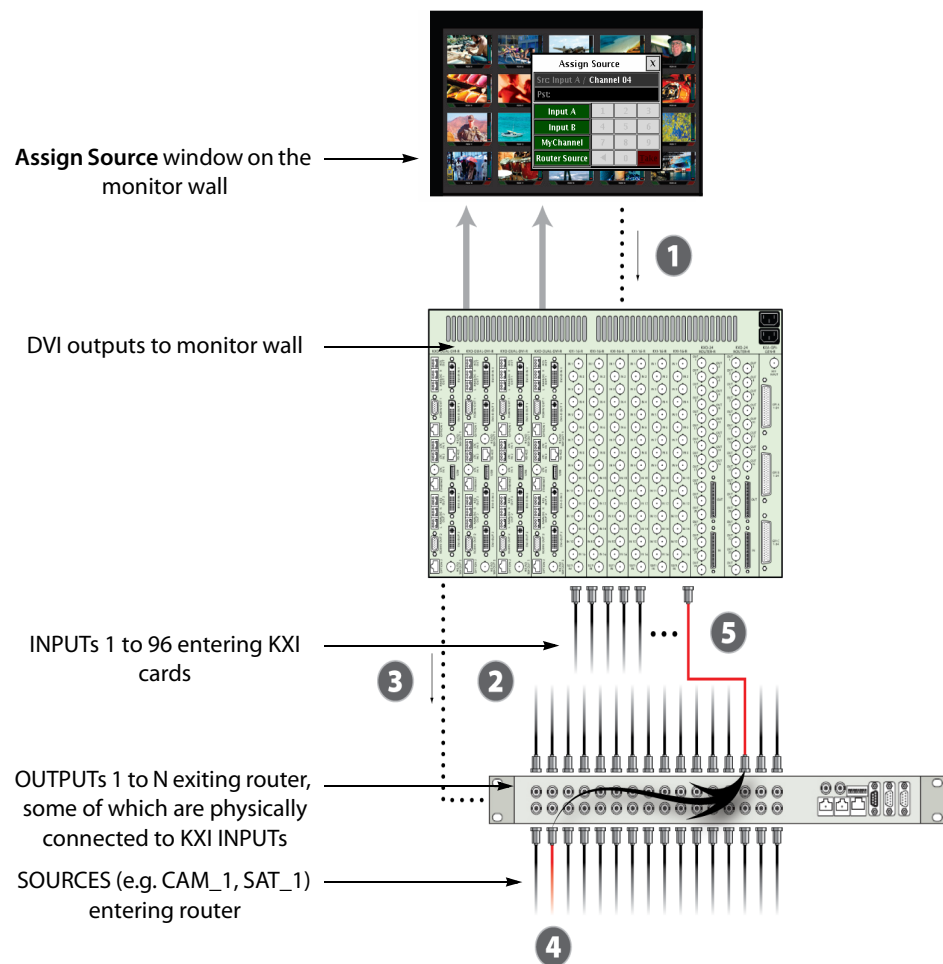

Assign Source window on the monitor wall

DVI outputs to monitor wall

INPUTs 1 to 96 entering KXI cards

OUTPUTs 1 to N exiting router, some of which are physically connected to KXI INPUTs

SOURCES (e.g. CAM\_1, SAT\_1) entering router

- 1 An operator right-clicks a monitor and assigns a logical source by using the **Assign Source** window.

---

**Note:** It may also be possible to select a source from the **Assign [router] input** menu (see [Changing an External Router Crosspoint](#), on page 57). However, as of version 5.20 of the Kaleido-X software, Grass Valley strongly recommends configuring the *KX Router* logical router to cover all routing purposes within the multiviewer system.

---

- 2 The **Router connections** tab in XEdit allows you to map physical connections between a number of INPUT connectors on the multiviewer and the upstream router's OUTPUTS that feed them, which allows the Kaleido-X software to determine the crosspoint switch needed.
- 3 The multiviewer sends this command to the external router, over a serial or TCP/IP connection, using the appropriate protocol.
- 4 The external router redirects the specified source signal.
- 5 The new signal follows the physical connection to one of the multiviewer inputs reserved for this purpose, is processed, and appears on the monitor wall.



## To configure router connections

- 1 Click the **Router connections** tab, which lists all multiviewer inputs and, for each, the associated output connector from a router. For each multiviewer input you wish to connect to an external router (e.g. INPUT A – Video 01), click the first menu (under **Router**) and choose a physical router level (e.g. “MyRouter” – Video).

System		
Channels/Sources		
Destinations		
Rooms		
Layouts		
RCP users		
Actions		
Description/Calibrations		
Interconnects		
Router configurations		
Router connections		
Inputs	Router outputs	
	Router	Port
INPUT A - Video 01 ←	MyRouter - Video	---
INPUT A - Video 02 ←	Unconnected	---
INPUT A - Video 03 ←	OPTION A	---
INPUT A - Video 04 ←	emulSZ - Level 0	---
INPUT A - Video 05 ←	MyRouter - Video	---
INPUT A - Video 06 ←	Unconnected	---
INPUT A - Video 07 ←	Unconnected	---
INPUT A - Video 08 ←	Unconnected	---
INPUT A - Video 09 ←	Unconnected	---

↑ Maps to BNC connectors on the multiviewer      ↑ The name of the physical router      ↑ Maps to OUTPUT BNC connectors on the physical router

**Note:** *Unconnected* means that this multiviewer input is *not connected to a router output*. For example, the input might be directly connected to a source signal.

- 2 Click the second menu and choose the appropriate output (e.g. “Output 1 [1]”).

Description/Calibrations		
Interconnects		
Router configurations		
Router connections		
Inputs	Router outputs	
	Router	Port
INPUT A - Video 01 ←	MyRouter - Video	---
INPUT A - Video 02 ←	Unconnected	---
INPUT A - Video 03 ←	Unconnected	Output 1 [1]
INPUT A - Video 04 ←	Unconnected	Output 2 [2]
INPUT A - Video 05 ←	Unconnected	Output 3 [3]
INPUT A - Video 06 ←	Unconnected	Output 4 [4]
INPUT A - Video 07 ←	Unconnected	---
INPUT A - Video 08 ←	Unconnected	---

In this example, the Kaleido-X software registers that Output 1 from the router has a cable that connects to the BNC connector corresponding to Video 1 on the multiviewer’s INPUT A module. This means that when you select a router source to be assigned to a monitor on the monitor wall, the Kaleido-X software will be able to determine whether the multiviewer’s INPUT A – Video 01 connector is available, and, if so, request the appropriate crosspoint change for “Output 1” of “MyRouter”.

- 3 Use the incremental copy tool to assign the next router outputs to contiguous multiviewer inputs.

Description/Calibrations		
Interconnects		
Router configurations		
Router connections		
Inputs	Router outputs	
	Router	Port
INPUT A - Video 01 ←	MyRouter - Video	Output 1 [1]
INPUT A - Video 02 ←	Unconnected	---
INPUT A - Video 03 ←	Unconnected	---
INPUT A - Video 04 ←	Unconnected	---
INPUT A - Video 05 ←	Unconnected	---
INPUT A - Video 06 ←	Unconnected	---
INPUT A - Video 07 ←	Unconnected	---
INPUT A - Video 08 ←	Unconnected	---

---

### Notes

- Using the incremental copy tool in the **Router** column only copies the selected router to the next rows.
  - Using the incremental copy tool in the **Port** column inserts the next output ports from the selected router in sequence, based on their Destination ID, until the last output port has been mapped, at which point using the incremental copy tool further will clear the subsequent cells.
  - When using the tool in the **Port** column, the **Router** column is populated accordingly.
  - It is possible to select the same output port more than once.
  - You can resize the router connections table by dragging column boundaries, or by using the double or triple click features described in the [Logical Sources](#) chapter. See [Resizing the Sources Table's Columns](#) on page 192, for details.
-

# 13

## Tally Interface Devices & Timer Systems

This chapter describes how multiviewers can be configured to receive dynamic labels and status from tally interface devices, timer, time code and status information from a timer system, or status from a GPI module.

### Summary

<i>Alpermann+Velte Timer System</i> .....	376
<i>GPI-1501 General Purpose Interface I/O Module</i> .....	381
<i>Configuring Serial Tally Systems</i> .....	387
<i>Ross Video Production Switcher</i> .....	389
<i>Sony Production Switcher</i> .....	394
<i>Kahuna Production Switcher</i> .....	398
<i>Kayak Production Switcher</i> .....	404
<i>Kayenne Production Switcher</i> .....	411
<i>K-Frame Switchers</i> .....	419
<i>Zodiak Production Switcher</i> .....	427
<i>Serial Port Test Agent</i> .....	434

### Overview

Kaleido multiviewer systems support most production switchers and other tally interface devices such as UMD controllers and automation systems, via a serial or network connection. Some timer systems and GPI I/O modules are also supported via a network connection. The multiviewer can dynamically update monitor wall elements to reflect text and status updates from the devices.

### Key Concepts

#### Optional Drivers for Controlling Tally Interface Devices from the Multiviewer

Optional drivers are available to extend your Kaleido-X system with the ability to control tally interface devices such as the ones listed in the tables below. Contact your sales representative for more information.

### Production Switchers

Company	Device/System
Grass Valley (Thomson)	Kayenne K-Frame, Karrera K-Frame, Kayenne, Kalypso, Zodiac, KayakDD, Kayak SD/HD, DD35, XtenDD HD/SD series
Ross	Synergy, and Vision Tritium series (via the Kalypso Serial Tally Protocol)
Snell & Wilcox	Kahuna
Sony	DVS-9000, MVS-8000, MFS-2000

### UMD controllers

Company	Device/System
Grass Valley (Thomson)	Andromeda UMD Controller
Image Video	TSI-1000 Tally System Interface (requires option from Image Video)
TSL	UMD Controller (serial, TCP/IP or UDP/IP)

### Automation systems

Company	Device/System
Imagine Communications (Harris/Encoda)	D-Series Playout Automation, A7500 Dual Master Automation
Sundance Digital	Fastbreak NXT Automation (requires option from Sundance Digital)

## Detailed Directions

### Alpermann+Velte Timer System

---

Note: The Kaleido-X software supports Alpermann+Velte timer systems that comprise a Rubidium series IE module with firmware version 2.14.24 or later, and option R (Timer Request Protocol) enabled. Only the *Basic* timer format mode is available.

---

For your multiviewer to receive time code information from an Alpermann+Velte timer system, and to display the system's contribution on the monitor wall, you need to configure your multiviewer's Alpermann+Velte service, by performing the following tasks in XEdit:

- 1 Add the Alpermann+Velte timer system to your multiviewer system configuration, and set up the communication parameters (see [Adding a Timer System to your Multiviewer Configuration](#), below).
- 2 Add logical sources and configure them by assigning alarms (or text elements) from the Alpermann+Velte timer system to the logical sources' alarm (or text) levels (see

[Assigning Timer System Information to Logical Sources](#), on page 378).

- 3 Assign the appropriate alarm and text levels from logical sources, to layout elements such as time code monitors, UMDs or alarm monitors (see [Configuring Layout Elements](#), on page 380).

## Adding a Timer System to your Multiviewer Configuration

### To add an Alpermann+Velte timer system to your multiviewer configuration

- 1 Open XEdit.
- 2 Connect to the multiviewer, if you wish to apply your changes in real time (see [Connecting to a Multiviewer](#), on page 76).

**Note:** If this step is omitted, then you will need to export the database to apply the changes.

- 3 In the main window, click the **System** tab, and then click **Description/Calibrations** on the second-level tab bar. The main pane displays the System hierarchical list, and the **Tools** pane displays the equipment library when the root of the System list is selected.
- 4 Drag the **Alpermann+Velte timer system** device from the equipment library onto the root of the System hierarchical list.

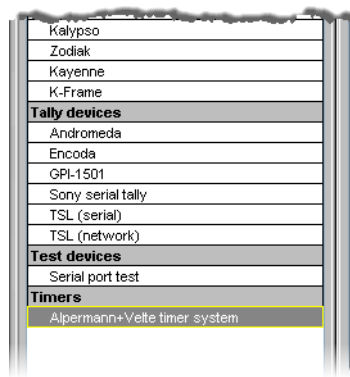

Alternatively, right-click the list root, and then click **Insert Alpermann+Velte timer system** on the menu.

A window appears, prompting you for a device identifier.

- 5 In **Device Identifier**, type a name for the timer system, and then click **OK**.



The timer system is added to the system list.

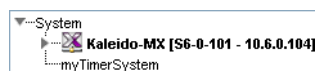

- 6 Click the **Interconnects** tab.
- 7 Position the pointer over the multiviewer icon, then click and drag towards the timer system icon.

A line representing the connection between the multiviewer and the device appears.

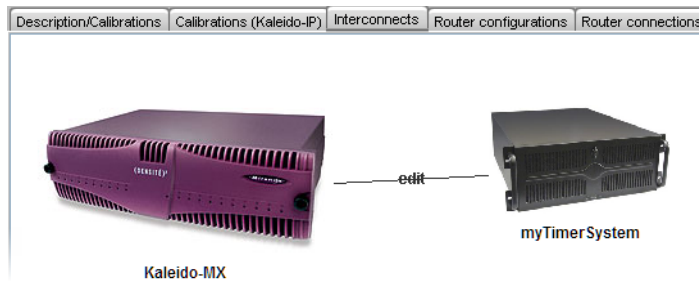

- 8 Click the connection line between multiviewer and device.
- 9 In the **Properties** pane, select **Network (TCP/IP)** from the **Transport type** list.

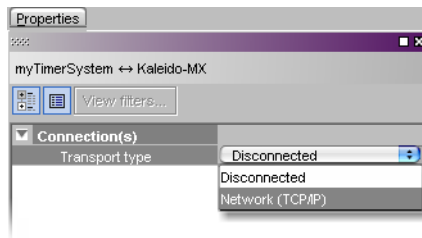

- 10 In the **Interconnects** tab, click the timer system icon.
- 11 In the **Properties** pane, type the IP address of your timer system.

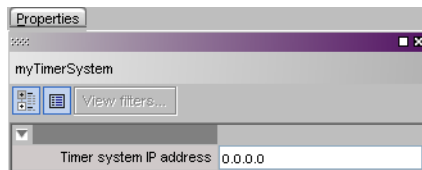

You are now ready to add information from the timer system to logical sources.

## Assigning Timer System Information to Logical Sources

### To configure your logical sources

- 1 In the **Channels/Sources** tab, add the required number of logical sources for your purposes (see [Manually adding a Logical Source](#), on page 181).
- 2 Add the required number of text and alarm levels for your purposes (see [Adding a level](#), on page 182).  
For example, you might add one text level named *Timer*, and one alarm level named *Timer status*.
- 3 Click a cell that corresponds to the appropriate *text* level of a logical source you wish to configure.
- 4 In the filtered System list, navigate to the text element you wish to monitor, and drag it onto the selected cell.

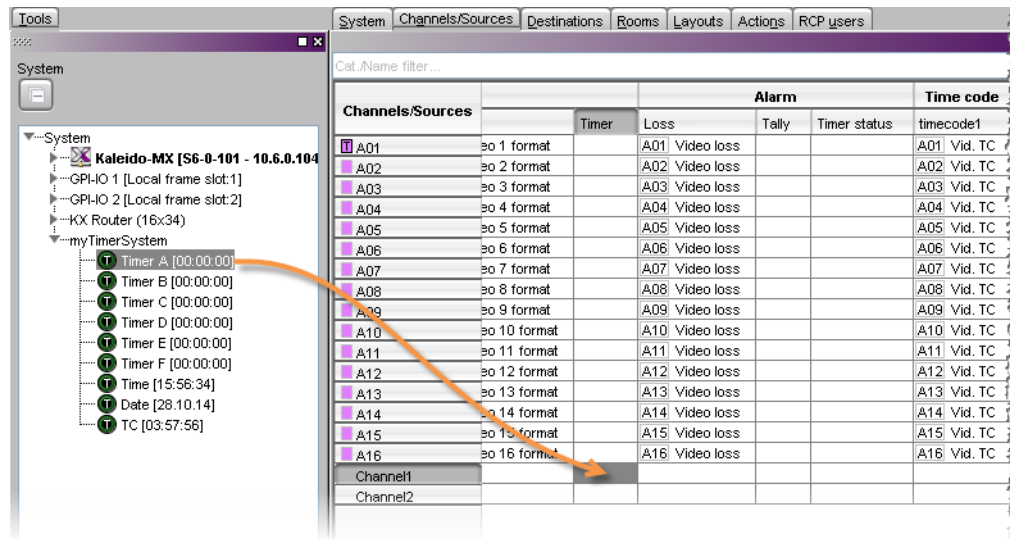

- 5 If your logical sources include more text levels to be associated with the timer system, then repeat [step 3](#) and [step 4](#) for the current logical source's remaining text levels.
- 6 Click a cell that corresponds to the appropriate *alarm* level of a logical source you wish to configure.
- 7 In the filtered System list, navigate to the alarm element you wish to monitor, and drag it onto the selected cell.

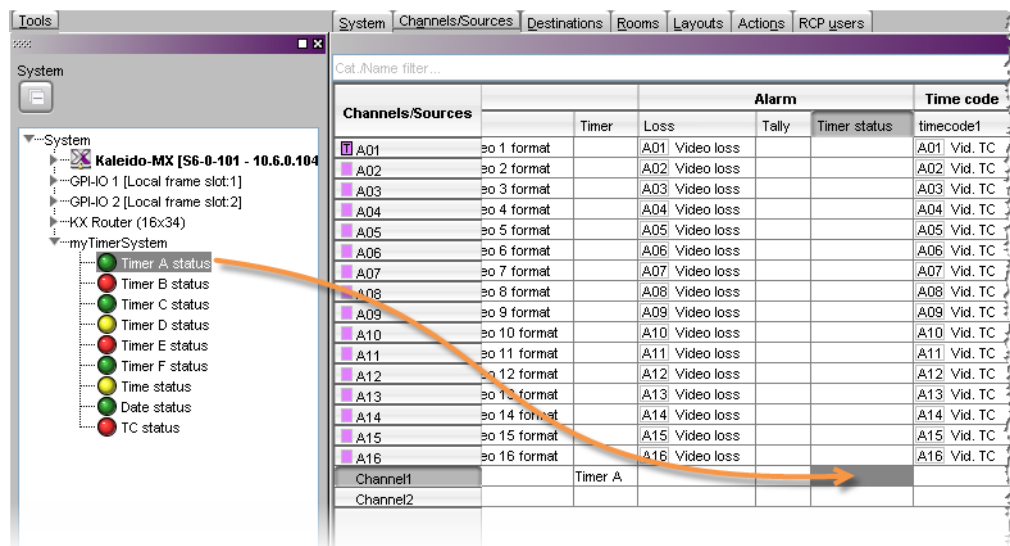

- 8 If your logical sources include more alarm levels to be associated with the timer system, then repeat [step 6](#) and [step 7](#) for the current logical source's remaining alarm levels.
- 9 Repeat [step 3](#)–[step 8](#) for any remaining logical sources you wish to configure with information from the timer system.
- 10 On the **File** menu, click **Save**.  
Changes to the sources table are saved.

## Configuring Layout Elements

You can now assign the logical sources you previously configured (see [Assigning Timer System Information to Logical Sources](#), on page 378) to UMDs or other monitors that can display text or alarms (e.g. time code monitors, alarm monitors) in a layout. Depending on your purposes, you will assign the appropriate text or alarm levels to specific components within the monitors.

For example, you might configure the assignments for an alarm monitor, by replacing the default alarm level and text label level assignments (both set to *GlobalAlarm*, by default) with an alarm level associated with the timer system, and the corresponding text level, respectively.

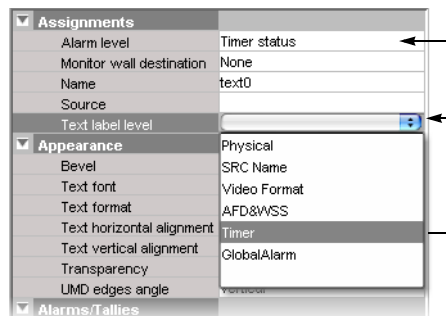

The procedure below explains how to configure a UMD to report timer text and status.

### To configure a UMD for dynamic reporting of text and status from a timer system

- 1 Click the **Layouts** tab, and then open the desired layout.
- 2 Add a UMD from the set of predefined UMDs available in the **Tools** pane (e.g., *umd2*), or use the UMD button  on the toolbar (see [Configuring UMDs](#), on page 267, and [Working with Composite Monitors](#), on page 289, if needed).
- 3 In the **Tools** pane, select one of the logical sources you previously configured (see [Assigning Timer System Information to Logical Sources](#), on page 378) from the filtered **Channels/Sources** list, and then drag it onto the UMD.
- 4 In the **Properties** pane, click the **Text label level** box, and then select the text level you wish to monitor (e.g., the *Timer* level you configured on [page 378](#)).

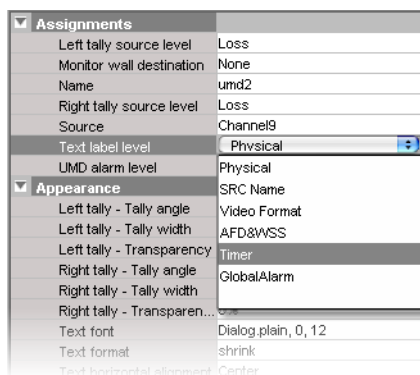

- 5 Click the **UMD alarm level** box, and then select the alarm level you wish to monitor (e.g., the *Timer status* level you configured on [page 378](#)).



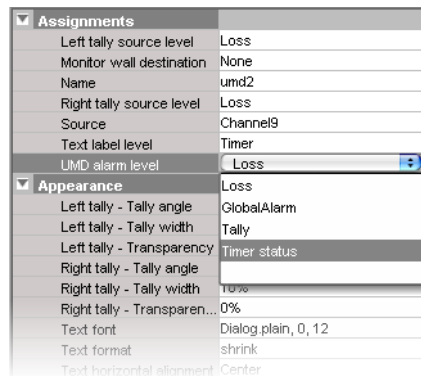

- 6 Select a monospace font for the text:
  - a Click the **Text font** box, and then click the button that appears inside the box to open the font picker window.
  - b In **Select a Font**, click a monospace font (e.g., Lucida Sans Typewriter), and then click **OK** to close the window.

Alternatively, set the text to be left-aligned by clicking the **Text horizontal alignment** box, and then selecting **Left** from the list.

- 7 Click outside the composite to lock it, if applicable.
- 8 On the **File** menu, click **Save**.
- 9 If you have been working in offline mode, then export the database to your multiviewer (see [Exporting a Database](#), on page 80).

On the monitor wall, you can now load the layout containing the monitors that were assigned information from the Alpermann+Velte timer system. Text and status information from the device will be visible on the monitor wall. Any changes made by the device's operator will be immediately reflected on the monitor wall.

## GPI-1501 General Purpose Interface I/O Module

The GPI-1501 is a 2RU Densité card that provides 20 dedicated GPI (General Purpose Interface) inputs plus eight terminals that can be individually configured as either a GPI input or GPI output. You may add one or more GPI-1501 modules to your multiviewer configuration to supplement the multiviewer's existing GPI interface or, in the case of a Kaleido-Modular-X system, to provide such an interface. Kaleido-MX multiviewer models ship with a pre-configured GPI-1501 card.

For example, you may resort to the GPI interface to receive tally information from a switcher whose specific protocol the multiviewer does not support, assuming the switcher is capable of communicating via GPI.

For your multiviewer to receive status information from a GPI-1501 module, and to display the module's contribution on the monitor wall as visual tally information, you need to configure your multiviewer's GPI-1501 service, by performing the following tasks in XEdit:

- 1 Add the GPI-1501 module to your multiviewer system configuration, and set up the communication parameters (see [Adding a GPI-1501 Module to your Multiviewer Configuration](#), below).

- 2 Configure logical sources by assigning GPI alarms from the GPI-1501 module to the logical sources' alarm levels (see [Assigning GPI Status Information to Logical Sources](#), on page 385).
- 3 Assign alarm levels from logical sources, to layout elements such as UMDs or alarm monitors (see [Configuring Layout Elements](#), on page 386).

## Adding a GPI-1501 Module to your Multiviewer Configuration

### To add a GPI-1501 module to your multiviewer system configuration

- 1 Open XEdit.
- 2 Connect to the multiviewer, if you wish to apply your changes in real time (see [Connecting to a Multiviewer](#), on page 76).

---

**Note:** If this step is omitted, then you will need to export the database to apply the changes.

---

- 3 In the main window, click the **System** tab, and then click **Description/Calibrations** on the second-level tab bar. The main pane displays the System hierarchical list, and the **Tools** pane displays the equipment library when the root of the System list is selected.
- 4 Drag the **GPI-1501** device from the equipment library onto the root of the System hierarchical list. Alternatively, right-click the list root, and then click **Insert GPI-1501** on the menu.

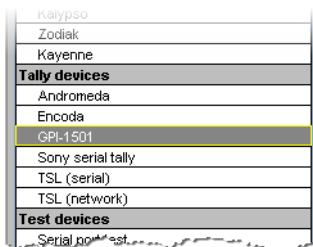

A window appears, prompting you for a device identifier.

- 5 In **Device Identifier**, type a name for the GPI-1501, and then click **OK**.



The GPI-1501 is added to the system list.

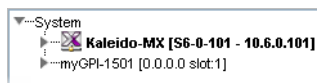

- 6 Click the **Interconnects** tab.
- 7 Position the pointer over the multiviewer icon, then click and drag towards the GPI-1501 icon.  
A line representing the connection between the multiviewer and the device appears.

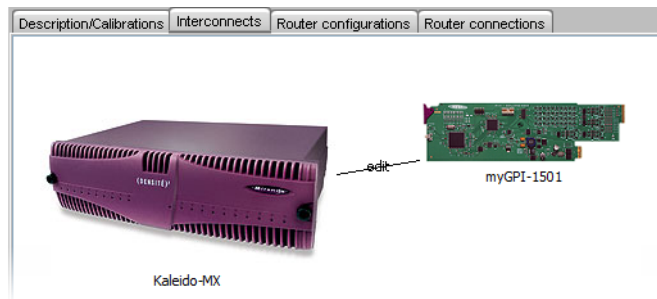

- 8 Click the connection line between multiviewer and device.
- 9 In the **Properties** pane, select **Network (TCP/IP)** from the **Transport type** list.

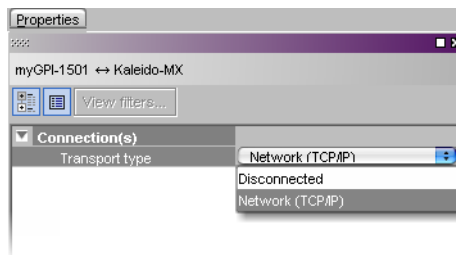

**Note:** In the case of a system with several GPI-1501 modules, some of which you do not necessarily use all the time, you may choose to momentarily disconnect those that are not in use, when you need to reduce network traffic, by selecting **Disconnected** from the **Transport type** list.

- 10 In the **Interconnects** tab, click the GPI-1501 icon.
- 11 In the **Properties** pane, type the number of the slot where your GPI-1501 card is located in its housing frame, directly in the **Slot number** box, or use the slider to set it.

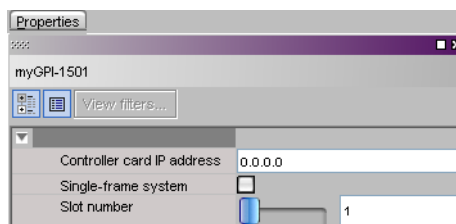

- In the case of a **Kaleido-Modular-X** multiviewer, if the GPI-1501 card and your multiviewer's output cards all share the same housing frame, then select the **Single-frame system** check box.
- **Kaleido-MX** multiviewers being single-frame systems, with a GPI-1501 card included, keeping the **Single-frame system** check box selected allows you to change the CPU-ETH2 controller's network settings, when needed, without having to revise communication parameters.
- In all other cases, enter the IP address of the Densité frame housing the GPI-1501 (use the IP address associated with the CPU-ETH2 controller card's ETH1 port).

- 12 If you wish to configure the GPI-1501 itself, click the **Description/Calibrations** tab, and then expand the appropriate GPI-1501 module in the System list.

**Note:** GPI-1501 configuration is only available when XEdit is connected to the multiviewer. If you were working in offline mode up to this point, you must now export the database to the multiviewer (see [Exporting a Database](#), on page 80), and then switch to online mode (see [Connecting to a Multiviewer](#), on page 76).

- a Click one of the eight configurable I/O terminals.

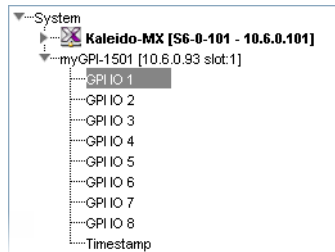

- b In the **Properties** pane, select the appropriate value from the **GPI IO direction** list, to configure the GPI line's direction (input or output).

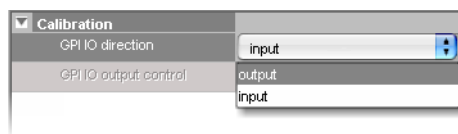

- c In the case of a GPI *output* line, if you wish to set its ON/OFF state manually for test purposes, then select either ON or OFF from the **GPI output control** list.

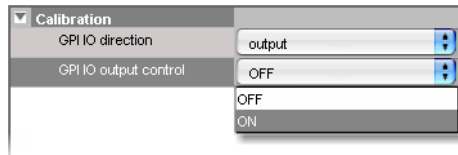

- d To configure the source of timestamp information, click the **Timestamp** element in the System list, and then, in the **Properties** pane, select the appropriate value from the **Timestamp source** list.

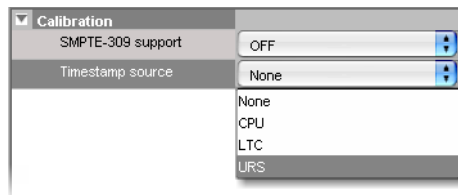

- **None:** No timestamping.
- **CPU:** Timestamping will be based on the Densité CPU-ETH2 controller card's real time clock.
- **LTC:** Timestamping will be based on the LTC signal at GPI input 20 if available. Selecting LTC as the timestamp source renders GPI input 20 unavailable for GPI purposes.

- **URS:** Timestamping will be based on the time information carried in the URS signal internal to the Densité housing frame. The URS is generated by a reference module (REF-1801) which must be installed in the frame for the URS to be available.
- e If you selected LTC, then you may enable SMPTE ST 309 support.

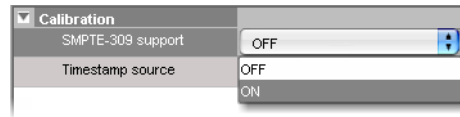

You are now ready to add information from the GPI-1501 to logical sources.

## Assigning GPI Status Information to Logical Sources

### To configure your logical sources

- 1 In the **Channels/Sources** tab, add the required number of alarm levels for your purposes (see [Creating and Configuring Logical Sources](#), on page 178). For example, you might add one alarm level named *On-air tally*.

New alarm level

Video	Audio	Text	Alarm
video1	audio1	text1	video format
A01	A01 Emb 1	InputA-video1	A01 Video format text
A02	A02 Emb 1	InputA-video2	A02 Video format text
A03	A03 Emb 1	InputA-video3	A03 Video format text
A04	A04 Emb 1	InputA-video4	A04 Video format text
			Loss
			On-air tally

- 2 Click a cell that corresponds to the appropriate alarm level of a logical source you wish to configure.
- 3 In the filtered System list, navigate to the GPI element you wish to monitor, and drag it onto the selected cell.

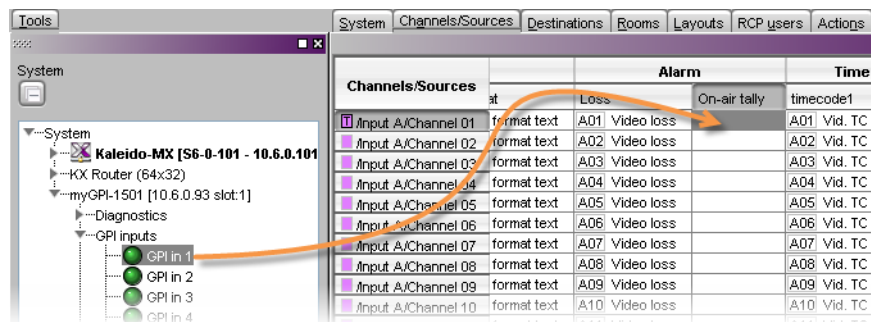

- 4 If your logical sources include more alarm levels to be associated with the GPI-1501, then repeat [step 2](#) and [step 3](#) for the current logical source's remaining alarm levels.
- 5 Make corresponding assignments to other logical sources by incremental copy, if desired (see [Making Further Assignments by Incremental Copy](#), on page 189).

Alarm level based on status information from the GPI-1501

Channels/Sources		Source info		Video		Audio		Text		Alarm		Time code	
#	Cat.	Name	video1	audio1	emb1	text1	video format	Loss	On-air tally	timecode1	LT	TC	LTG
1	Input A	Channel 01	A01	A01	Emb 1	InputA-video1	A01 Video format text	A01 Video loss	GPI In 1 [10.6.0.93:1]	A01	Vid.	TC	LTG
2	Input A	Channel 02	A02	A02	Emb 1	InputA-video2	A02 Video format text	A02 Video loss	GPI In 2 [10.6.0.93:1]	A02	Vid.	TC	LTG
3	Input A	Channel 03	A03	A03	Emb 1	InputA-video3	A03 Video format text	A03 Video loss	GPI In 3 [10.6.0.93:1]	A03	Vid.	TC	LTG
4	Input A	Channel 04	A04	A04	Emb 1	InputA-video4	A04 Video format text	A04 Video loss	GPI In 4 [10.6.0.93:1]	A04	Vid.	TC	LTG
5	Input A	Channel 05	A05	A05	Emb 1	InputA-video5	A05 Video format text	A05 Video loss	GPI In 5 [10.6.0.93:1]	A05	Vid.	TC	LTG

- On the **File** menu, click **Save**.  
 Changes to the sources table are saved.

### Configuring Layout Elements

You can now assign the logical sources you previously configured (see [Assigning GPI Status Information to Logical Sources](#), on page 385) to monitors that can display text or alarms (e.g. UMD, video, text alarm status) in a layout. Depending on your purposes, you will assign the appropriate text or alarm levels to specific components within the monitors. For example, you might select an alarm level as the source for an alarm monitor, and the *GlobalAlarm* level (see [Global Alarms](#), on page 155) as the text label level. The procedure below explains how to configure a UMD to report the On-air tally status.

#### To configure layout elements for dynamic text and tally reporting

- Click the **Layouts** tab, and then open the layout you wish to configure.
- In the **Tools** pane, select one of the logical sources you previously configured (see [Assigning GPI Status Information to Logical Sources](#), on page 385) from the filtered **Channels/Sources** list, and then drag it onto the appropriate monitor.
- Repeat [step 2](#) until you have assigned all the sources you wish to monitor to the appropriate monitors in your layout.
- Click a UMD whose tally reporting behavior you wish to set, after unlocking the composite monitor that contains it if applicable (see [Unlocking a Composite Monitor](#), on page 295).
- In the **Properties** pane, click the **Right tally source level** box, and then select the alarm level you wish to monitor (e.g. the *On-air tally* level you configured on [page 385](#)).

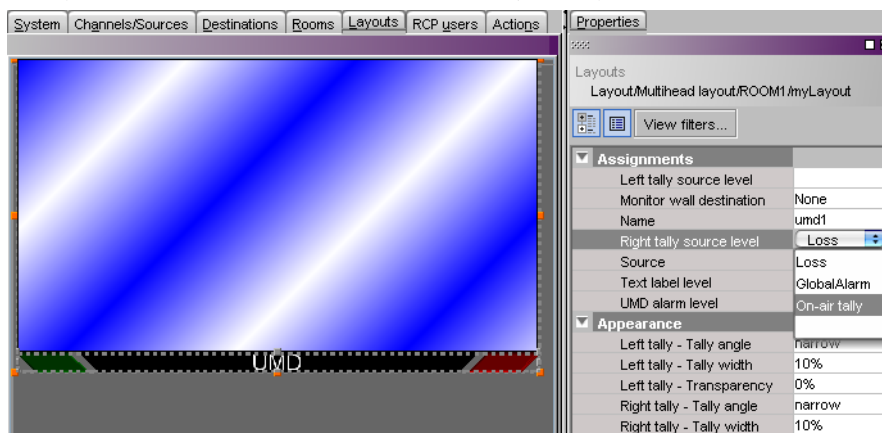

Alarm level selection for the right tally in a UMD

- 6 Click outside the composite to lock it, if applicable.
- 7 Repeat [step 4](#) and [step 5](#) until you have configured all UMDs that are to display tally status when this layout is loaded on the monitor wall.
- 8 On the **File** menu, click **Save**.
- 9 If you have been working in offline mode, then export the database to your multiviewer (see [Exporting a Database](#), on page 80).

On the monitor wall, you can now load the layout containing the monitors that were assigned tally information provided by the GPI-1501. Tally status from the device (e.g. a switcher) feeding the GPI-1501 module will be visible on the monitor wall. Any changes made by the device's operator will be immediately reflected on the monitor wall.

## Configuring Serial Tally Systems

This section covers the configuration of the Kalypso, Andromeda, Encoda, Serial to TCP/IP Dispatcher, and TSL *serial* devices, which can be added to a multiviewer system to receive and interpret serial tally information from peripheral devices. The illustrations, options or properties shown below may vary, depending on your actual system.

### To configure a serial tally system

- 1 In the main window, click the **System** tab, and then click **Description/Calibrations** on the second-level tab bar. The main pane displays the System hierarchical list, and the **Tools** pane displays the equipment library when the root of the System list is selected.
- 2 Drag the appropriate peripheral device from the equipment library onto the root of the System hierarchical list. Alternatively, right-click the list root, and then click the appropriate peripheral device on the menu.

A window appears, prompting you for a device identifier.



- 3 Type a name for the peripheral device, and then click **OK**.
- 4 Click the **Interconnects** tab.
- 5 Click the multiviewer icon and hold the mouse button, while dragging the pointer towards the peripheral device icon.  
A line representing the connection between the multiviewer and the device appears.

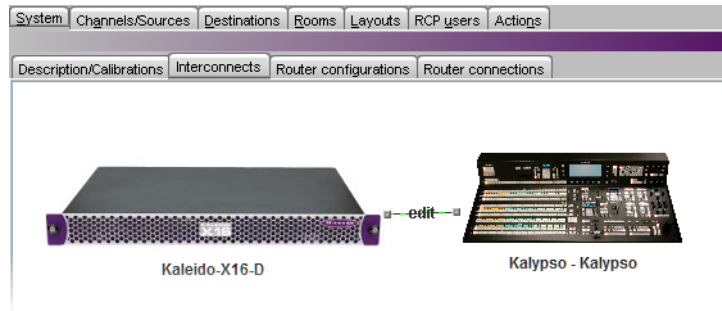

Connection between the multiviewer and the device (example using Kalypso, same for all devices)

- 6 Click the connection line between the multiviewer and the device.
- 7 In the **Properties** pane, select the appropriate element from the **RS-422 communication port** list.

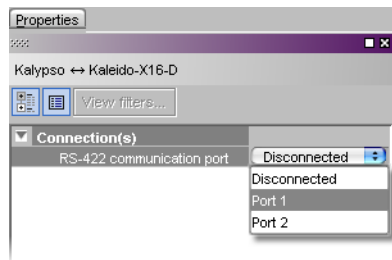

Depending on the multiviewer model, the available RS-422 ports are designated as follows:

KMV-3901/3911	RS-422
Kaleido-X16	Port 1, and Port 2
Kaleido-X (14RU)	Frame A – Output A, B, and C; Frame B – Output A, B, and C
Kaleido-X (7RU)	Output A, B, C, and D
Kaleido-X (4RU)	Output A, and B
Kaleido-MX	Output A, and B Note: The Kaleido-MX (1RU) 16 × 4 model has only one RS-422 port, which is physically connected to output card A.
Kaleido-Modular-X	Output A, and B Note: KMX-3901-OUT output cards with a single rear connector panel (KMX-3901-OUT-D-3+SRP) do not have RS-422 ports. To support a serial device, your Kaleido-Modular-X system must have at least one output card with a double rear connector panel (KMX-3901-OUT-D-3DRP).

- 8 Click the peripheral device icon in the **Interconnects** tab.
- 9 In the **Properties** pane, set the serial communications properties for the device. The set of properties will vary, depending on the device. Refer to the manufacturer's documentation for your specific device as needed.



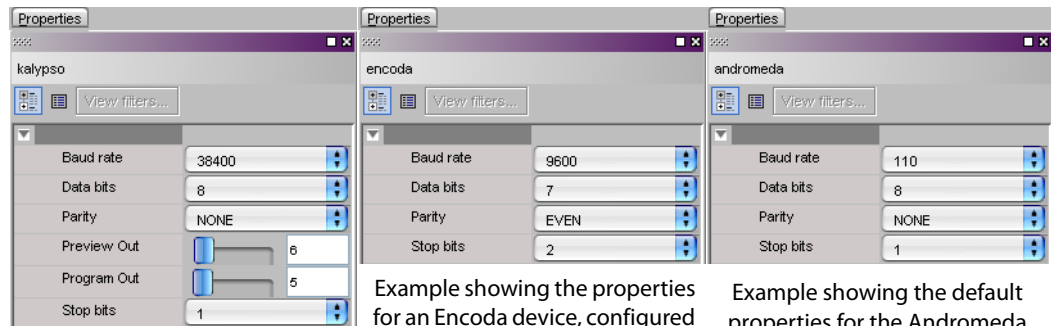

Example showing the default properties for the Kalypso device

Example showing the properties for an Encoda device, configured to reflect the current settings on an actual A7500 automation system

Example showing the default properties for the Andromeda device (the Encoda device has the same default properties)

*Serial communications properties examples*

- 10 On the **File** menu, click **Save**.

## Ross Video Production Switcher

A multiviewer can receive dynamic source names and tally information from a Ross Video production switcher (Synergy 2, 3, 4 SD/MD and Vision models). The procedures below describe how to set up the multiviewer to interface with a Ross Video switcher.

### To set up the Ross Video production switcher

- 1 Enable the contribution serial tally interface on one of the switcher's ports, by using the switcher's installation menu: from the HOME menu, press **More > Setup > Installation > Comm Setup**, and then configure the serial tally device as follows:

Menu	Field	Value	Sub-value
Type	Com Port	[any REMOTE or PERIPH port (depending on device), or the EDITOR port (on a Synergy 100 panel)]	
	Device	Serial Tally	
SelectDevice	Device	Contrib	
Comm Setting	Baud	38 400-115 200	
	Parity	NONE	
Comm Type	Type	RS-422	
Extra Option	Option	Rate	26
	Option	Data Txfr	Complete
	Option	Start	None
	Option	At Black	All Off

---

**Note:** For more information on installing port devices, please refer to your Ross switcher documentation. The communication parameters listed above are recommended values. Other values may also work, but remember that both the switcher and the multiviewer must be configured with the same values.

---

- 2 Physically connect one end of an RJ-45 straight-through cable to the multiviewer's RS-422 port.
- 3 Using the *straight* DE-9S-to-RJ-45 adapter (part no. 1737-3000-102), connect the other end of the cable to the enabled serial tally port on the switcher.

---

**Note:** Since the protocol is unidirectional, only the transmit pins are required from the switcher's remote port. See [RS-422 Connection Diagram](#), on page 25 for pinouts on the multiviewer.

---

Required pins	Signal
7	TX+
2	TX-

#### To set up the multiviewer

- 1 Open XEdit.
- 2 In the main window, click the **System** tab, and then click **Description/Calibrations** on the second-level tab bar. The main pane displays the System hierarchical list, and the **Tools** pane displays the equipment library when the root of the System list is selected.

- 3 Drag the **Kalypso** device from the equipment library onto the root of the System hierarchical list. Alternatively, right-click the list root, and then click **Insert Kalypso** on the menu.

**Note:** On the multiviewer, Kalypso is the module that receives and interprets serial tally information from Ross Video production switchers.

A window appears, prompting you for a device identifier.



- 4 Type a name for the Kalypso device, and then click **OK**.
- 5 Click the **Interconnects** tab.
- 6 Position the pointer over the multiviewer icon, then click and drag towards the Kalypso device icon.

A line representing the connection between the multiviewer and the device appears.

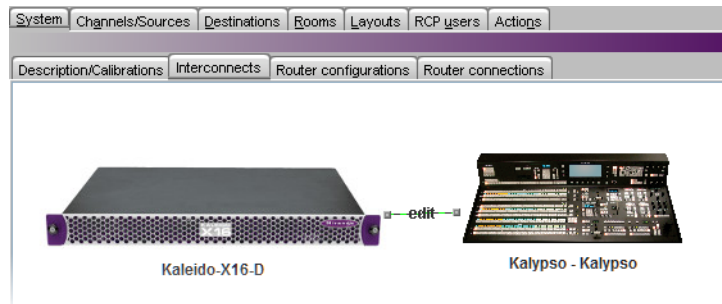

*Connection between the multiviewer and the device*

- 7 Click the connection line between the multiviewer and the device.
- 8 In the **Properties** pane, select the appropriate element from the **RS-422 communication port** list.

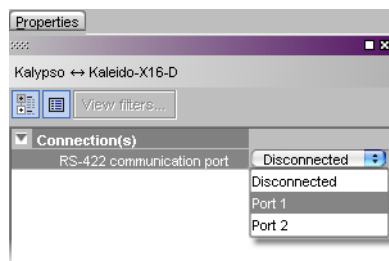

Depending on the multiviewer model, the available RS-422 ports are designated as follows:

KMV-3901/3911	RS-422
Kaleido-X16	Port 1, and Port 2
Kaleido-X (14RU)	Frame A – Output A, B, and C; Frame B – Output A, B, and C

Kaleido-X (7RU)	Output A, B, C, and D
Kaleido-X (4RU)	Output A, and B
Kaleido-MX	Output A, and B Note: The Kaleido-MX (1RU) 16×4 model has only one RS-422 port, which is physically connected to output card A.
Kaleido-Modular-X	Output A, and B Note: KMX-3901-OUT output cards with a single rear connector panel (KMX-3901-OUT-D-3+SRP) do <i>not</i> have RS-422 ports. To support a serial device, your Kaleido-Modular-X system must have at least one output card with a double rear connector panel (KMX-3901-OUT-D-3DRP).

- 9 In the **Interconnects** tab, click the Kalypso device icon.
- 10 In the **Properties** pane, set the serial communications properties for the remote port on the Ross Video switcher as follows:

Baud rate	38 400-115 200
Data bits	8
Parity	NONE
Stop bits	1

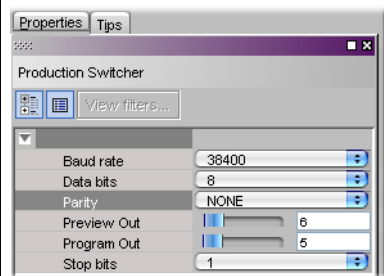

- 11 In the **Channels/Sources** tab, configure logical sources using text sources and system tallies from the Kalypso serial tally device.

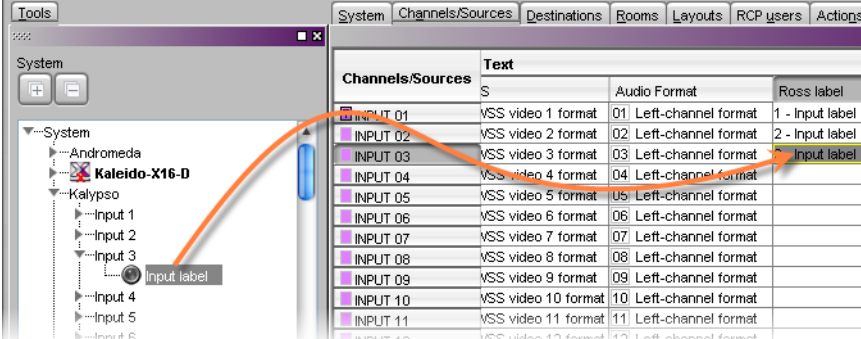

Channels/Sources	Text	Audio Format	Ross label
INPUT 01	VSS video 1 format	01 Left-channel format	1 - Input label
INPUT 02	VSS video 2 format	02 Left-channel format	2 - Input label
INPUT 03	VSS video 3 format	03 Left-channel format	Input label
INPUT 04	VSS video 4 format	04 Left-channel format	
INPUT 05	VSS video 5 format	05 Left-channel format	
INPUT 06	VSS video 6 format	06 Left-channel format	
INPUT 07	VSS video 7 format	07 Left-channel format	
INPUT 08	VSS video 8 format	08 Left-channel format	
INPUT 09	VSS video 9 format	09 Left-channel format	
INPUT 10	VSS video 10 format	10 Left-channel format	
INPUT 11	VSS video 11 format	11 Left-channel format	
INPUT 12	VSS video 12 format	12 Left-channel format	

**Note:** Refer to the table below for a list of valid source IDs and their meaning in the context of the Kalypso serial tally protocol.

Source IDs	Kalypso
1 - 92	Inputs 1 - 92
93	M/E 1 PGM A

Source IDs	Kalypso
94	M/E 1 PGM B
95	M/E 1 PGM C
96	M/E 1 PGM D
97	M/E 1 PVW A
98	M/E 1 PVW 2
99*	M/E 2 PGM A
100*	M/E 2 PGM B
101*	M/E 2 PGM C
102*	M/E 2 PGM D
103*	M/E 2 PVW A
104*	M/E 2 PVW 2
105*	M/E 3 PGM A
106*	M/E 3 PGM B
107*	M/E 3 PGM C
108*	M/E 3 PGM D
109*	M/E 3 PVW A
110*	M/E 3 PVW 2
111	Pgm-Pst PGM A
112	Pgm-Pst PGM B
113	Pgm-Pst PGM C
114	Pgm-Pst PGM D
115	Pgm-Pst PVW A
116	Pgm-Pst PVW 2
117	Test Signal
118	Black
119	Background 1
120	Background 2
121	Still Store 1
122	Still Store 2
123	Still Store 3
124	Still Store 4
125	Still Store 5
126	Still Store 6
127	Still Store 7
128	Still Store 8

\* 2-M/E systems do not have these sources.

- 12 In the **Layouts** tab, create layouts and assign logical sources created in [step 11](#) to monitors that can display text (e.g. UMD) and alarms (e.g. UMD, video, text alarm).

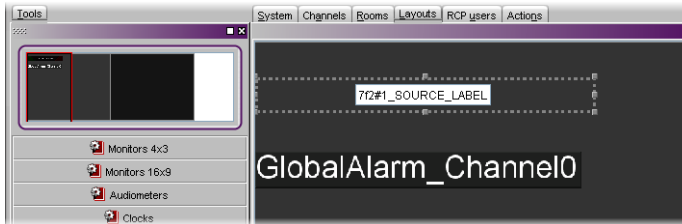

- 13 On the **File** menu, click **Save**.
- 14 On the **Configure** menu, point to **Database**, and then click **Export** to export the database to your multiviewer.
- 15 On the multiviewer, load the layout containing the monitors assigned to dynamic text and tallies coming from the Ross Video switcher.  
You should see source names and tallies from the Ross Video switcher on the monitor wall.

## Sony Production Switcher

A multiviewer can receive dynamic source names and tally information from a Sony switcher. The procedure below describes how to set up a multiviewer to interface with a Sony production switcher (DVS-9000 series, MVS-8000 series or MFS-2000 series).

### Setting Up a Sony Switcher

#### To set up a Sony switcher

- 1 Enable *serial tally* on one of the switcher's ports (refer to your Sony Production Switcher System User's Guide for details).

---

**Note:** There are no serial tally connections on the Sony switcher model DVS-9000. See [DVS-9000 switchers](#) on page 394 for details.

---

- 2 Physically connect one end of an RJ-45 straight cable to the multiviewer's RS-422 port.
- 3 Using a DE-9S-to-RJ-45 crossover adapter (Grass Valley part no. 1792-3700-100), connect the other end of the cable to the enabled serial tally port on the Sony switcher. See [RS-422 Connection Diagram](#), on page 25 for pinouts on the multiviewer.

#### DVS-9000 switchers

Since there are no serial tally connections on the DVS-9000 switcher, you will need an additional device—either a Device Control Unit (DCU) or a System Control Unit (SCU)—between this switcher model and the multiviewer. Use a DCU model MKS-8700 or DCU-8000, or an SCU model MKS-8010A or MKS-8010B.

---

**Note: MKS-2700:** The 1 RU DCU model MKS-2700 does not have a serial tally connection, so serial tally must come from a MKS-8010A or MKS-8010B SCU.

---

- On a DCU (MKS-8700 or DCU-8000), use the connectors labeled *Serial Tally 1* and *Serial Tally 2*.

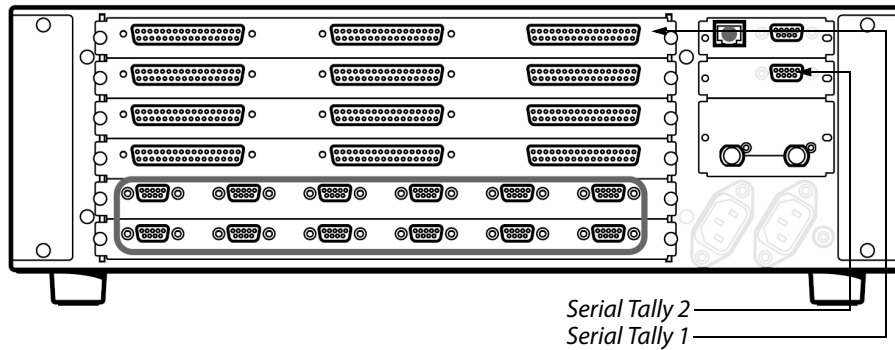

Sony Device Control Unit Pack (DCU-8000)

- On an SCU (MKS-8010A or MKS-8010B), use the 15-pin connector labeled *EDITOR PANEL*, with an adapter.

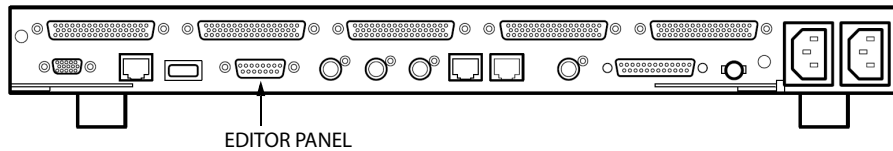

Sony System Control Unit (MKS-8010A)

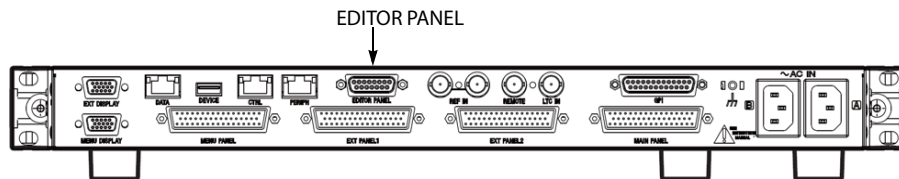

Sony System Control Unit (MKS-8010B)

To use a serial tally from an SCU model MKS-8010A or MKS-8010B, a 15-pin-to-9-pin adapter is required, with pinouts as follows:

MKS-8010A or MKS-8010B (15-pin)	SCU (Signal)	Serial tally device (9-pin)
2	RX-	2
3	TX+	3
10	RX+	7
11	TX-	8
4	GND	4

No adapter is required for SCU model MKS-8010, which has a DE-9 connector with the following pinout:

MKS-8010 (9-pin)	SCU (Signal)
2	RX-
3	TX+
7	RX+
8	TX-
4	GND

In addition, on Sony menu page 7367, you must enable R and G serial tallies on the SCU port.

---

Note: See [RS-422 Connection Diagram](#), on page 25 for pinouts on the multiviewer.

---

## Setting Up a Multiviewer to Interface with a Sony Production Switcher

### To set up the multiviewer to interface with the Sony production switcher

- 1 Open XEdit.
- 2 In the main window, click the **System** tab, and then click **Description/Calibrations** on the second-level tab bar. The main pane displays the System hierarchical list, and the **Tools** pane displays the equipment library when the root of the System list is selected.
- 3 Drag the **Sony** production switcher device from the equipment library onto the root of the System hierarchical list. Alternatively, right-click the list root, and then click **Insert Sony serial tally** on the menu.

A window appears, prompting you for a device identifier.



- 4 Type the name of the Sony production switcher, and then click **OK**.
- 5 Click the **Interconnects** tab.
- 6 Position the pointer over the multiviewer icon, then click and drag towards the Sony production switcher icon.

A line representing the connection between the multiviewer and the device appears.



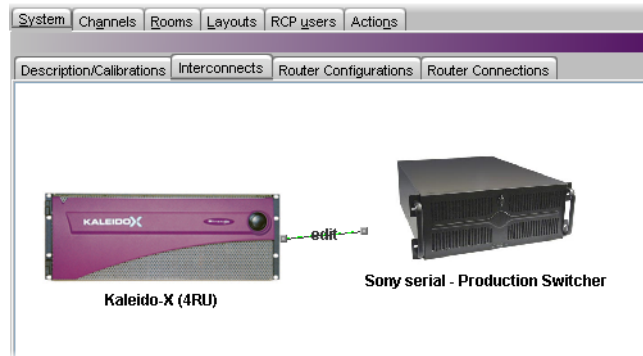

Connection between the multiviewer and the device

- 7 Click the connection line between the multiviewer and the device.
- 8 In the **Properties** pane, select the appropriate element from the **RS-422 communication port list**.

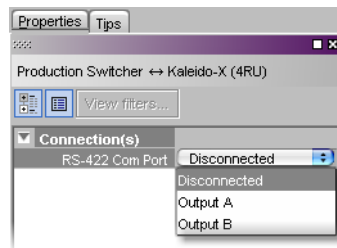

Depending on the multiviewer model, the available RS-422 ports are designated as follows:

KMV-3901/3911	RS-422
Kaleido-X16	Port 1, and Port 2
Kaleido-X (14RU)	Frame A – Output A, B, and C; Frame B – Output A, B, and C
Kaleido-X (7RU)	Output A, B, C, and D
Kaleido-X (4RU)	Output A, and B
Kaleido-MX	Output A, and B Note: The Kaleido-MX (1RU) 16×4 model has only one RS-422 port, which is physically connected to output card A.
Kaleido-Modular-X	Output A, and B Note: KMX-3901-OUT output cards with a single rear connector panel (KMX-3901-OUT-D-3+SRP) do <i>not</i> have RS-422 ports. To support a serial device, your Kaleido-Modular-X system must have at least one output card with a double rear connector panel (KMX-3901-OUT-D-3DRP).

- 9 In the **Interconnects** tab, click the **Sony** production switcher icon.

- 10 In the **Properties** pane, set the serial communications properties for the Sony device as follows:

Baud Rate	38 400
Data Bits	8
Parity	ODD
Stop bits	1

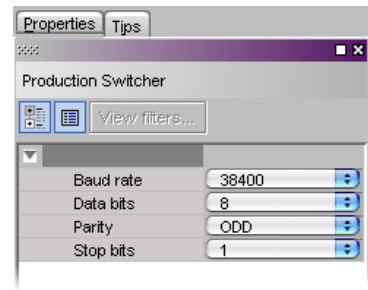

- 11 In the **Channels/Sources** tab, create logical sources using text and alarms levels coming from the Sony serial tally device.

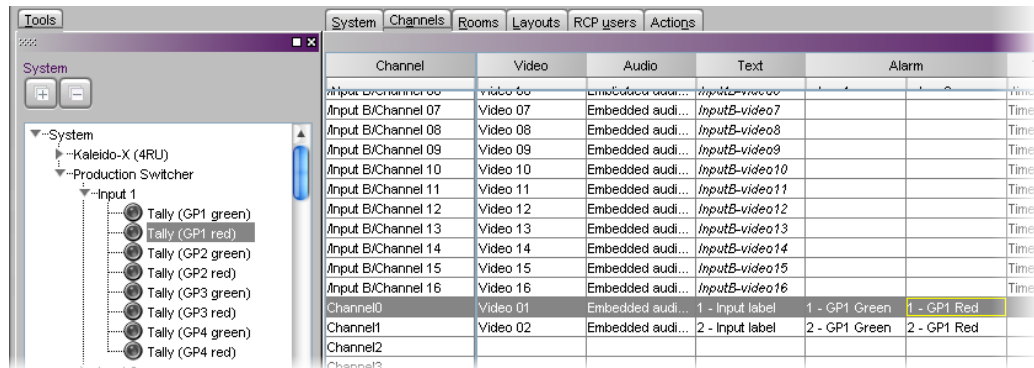

- 12 In the **Layouts** tab, create layouts and assign logical sources created in [step 11](#) to monitors that can display text (e.g. UMD) and alarms (e.g. UMD, video, text alarm).



- 13 On the **File** menu, click **Save**.
- 14 On the **Configure** menu, point to **Database**, and then click **Export** to export the database to your multiviewer.
- 15 On the multiviewer, load the layout containing the monitors assigned to dynamic text and tallies coming from the Sony switcher.
- You should see source names and tallies from the Sony switcher on the monitor wall.

## Kahuna Production Switcher

A multiviewer can receive dynamic source names and tally information from a Kahuna production switcher. The procedures below describe how to set up a multiviewer to interface with a Kahuna switcher.

### To set up the Kahuna switcher

- 1 Physically connect one end of an RJ-45 straight cable to the multiviewer's RS-422 port.

- Using a DE-9S-to-RJ-45 crossover adapter (Grass Valley part no. 1792-3700-100), connect the other end of the cable to the appropriate RS-422 control port on the Kahuna switcher. See [RS-422 Connection Diagram](#), on page 25 for pinouts on the multiviewer. The illustration below shows the location of the RS-422 ports on an 11RU Kahuna switcher. The RS-422 ports (highlighted) are numbered 1 – 8, from right to left. Refer to the *Kahuna Install Manual* for more details on the RS-422 control ports.<sup>4</sup>

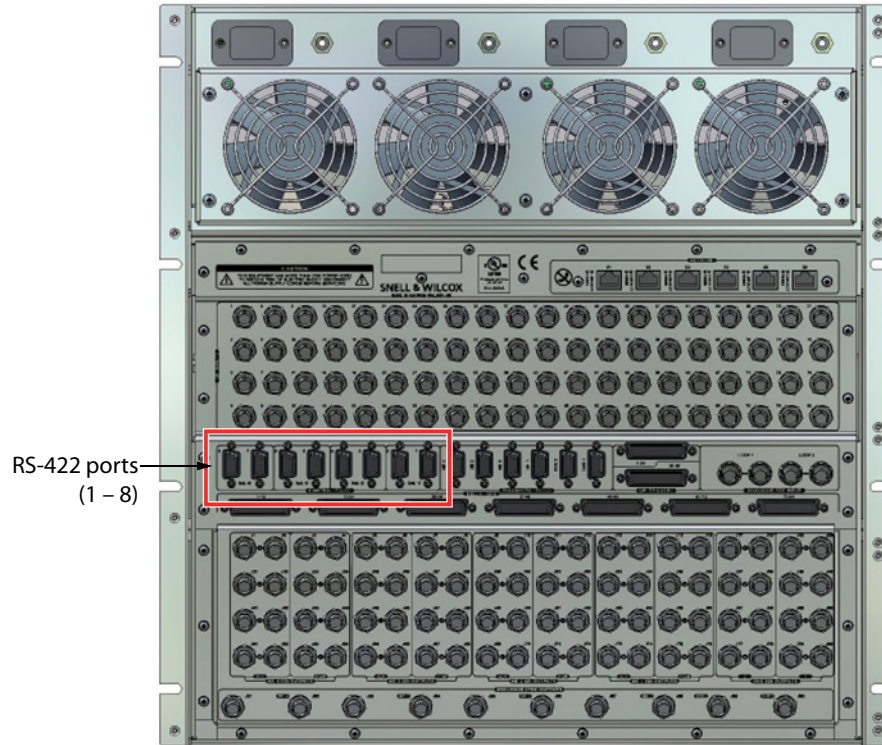

The Kahuna has DE-9 connectors with the following pinout:

9-pin	Signal
2	RX-
3	TX+
7	RX+
8	TX-
4	GND

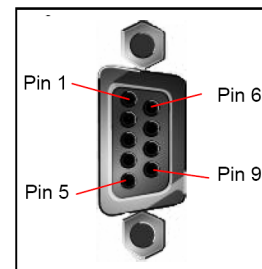

Note: See [RS-422 Connection Diagram](#), on page 25 for pinouts on the multiviewer.

- On the Kahuna switcher's GUI panel, press the **ENG CONFIG** button. The **Engineering Config** menu appears on the touch screen.

4. The Kahuna Install Manual is available here:  
<https://kahuna.snellgroup.com/kahunaclub/kahunacare/documents.php>

- 4 Touch the **Protocols** button on the screen to bring up the **Engineering Config – Serial Port Protocols** menu.
- 5 In the list of RS-422 ports, select the one to which you connected the crossover cable.
- 6 Set the communications parameters for the selected port as follows, using the rotary controls on the right of the GUI panel:

Protocol	Serial Tally
Baud Rate	115 200
Parity	NONE
Data Bits	8
Stop bits	1
Port Type	Master

- 7 On the Kahuna switcher’s GUI panel, press the **PERIPH** button  
The **Peripherals** menu appears.
- 8 Touch the **Tally Control** button on the screen to bring up the **Peripherals – Tally Protocol** menu.
- 9 Select the RS-422 port that is connected to the multiviewer, and set its serial protocol options as follows:

Extension Enable	On
Full Table Enable	On

---

#### Notes

- Refer to the *Kahuna User Instruction Manual* for further details on setting up the port protocols and tally protocol parameters (see <https://kahuna.snellgroup.com/kahunaclub/kahunacare/documents.php>).
  - Although it is possible to define “user configuration” source names on the Kahuna switcher, these are not transmitted over the serial tally interface. The switcher only transmits the “engineering configuration” source names.
- 

#### To set up the multiviewer

- 1 Open XEdit.
- 2 In the main window, click the **System** tab, and then click **Description/Calibrations** on the second-level tab bar. The main pane displays the System hierarchical list, and the **Tools** pane displays the equipment library when the root of the System list is selected.
- 3 Drag the **Kahuna** production switcher device from the equipment library onto the root of the System hierarchical list. Alternatively, right-click the list root, and then click **Insert Kahuna** on the menu.

A window appears, prompting you for a device identifier.



- 4 Type a name for the Kahuna production switcher, and then click **OK**.
- 5 Click the **Interconnects** tab.
- 6 Position the pointer over the multiviewer icon, then click and drag towards the Kahuna production switcher icon.

A line representing the connection between the multiviewer and the device appears.

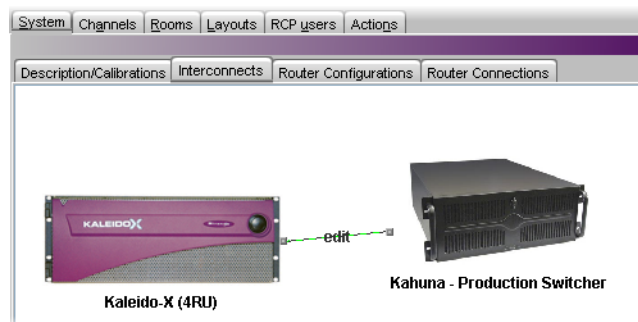

*Connection between the multiviewer and the device*

- 7 Click the connection line between multiviewer and device.
- 8 In the **Properties** pane, select the appropriate element from the **RS-422 communication port list**.

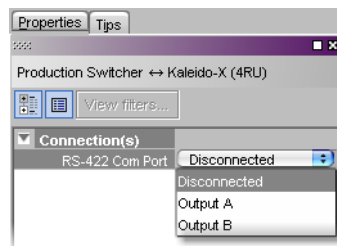

Depending on the multiviewer model, the available RS-422 ports are designated as follows:

KMV-3901/3911	RS-422
Kaleido-X16	Port 1, and Port 2
Kaleido-X (14RU)	Frame A – Output A, B, and C; Frame B – Output A, B, and C
Kaleido-X (7RU)	Output A, B, C, and D
Kaleido-X (4RU)	Output A, and B

Kaleido-MX	Output A, and B Note: The Kaleido-MX (1RU) 16×4 model has only one RS-422 port, which is physically connected to output card A.
Kaleido-Modular-X	Output A, and B Note: KMX-3901-OUT output cards with a single rear connector panel (KMX-3901-OUT-D-3+SRP) do not have RS-422 ports. To support a serial device, your Kaleido-Modular-X system must have at least one output card with a double rear connector panel (KMX-3901-OUT-D-3DRP).

- 9 In the **Interconnects** tab, click the **Kahuna** production switcher icon.
- 10 In the **Properties** pane, set the serial communications properties for the Kahuna device as follows:

Baud Rate	115200
Data Bits	8
Parity	NONE
Stop bits	1

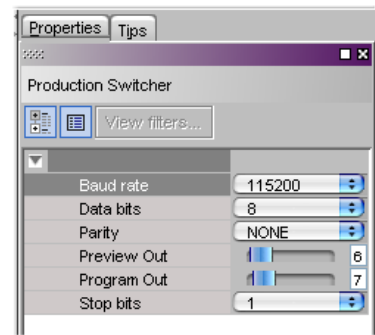

- 11 In the **Channels/Sources** tab, create logical sources using Text and Alarm elements coming from the Kahuna's serial tally information.

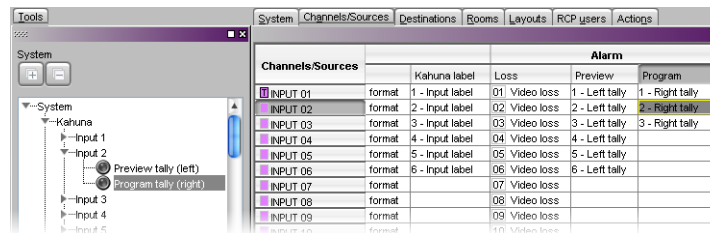

**Note:** Refer to the table below for a list of valid source IDs and their meaning in the context of the Kahuna serial tally protocol.

Source IDs	Kahuna
1 - 80	Inputs 1 - 80
81	Store 9
82	Store 10
83	Store 11
84	Store 12
85	Store 13
86	Store 14
87	Store 15
88	Store 16

Source IDs	Kahuna
89	DVE 1 Output 1
90	DVE 1 Output 2
91	DVE 1 Output 3
92	DVE 1 Output 4
93	M/E 1 Output 1
94	M/E 1 Output 2
95	M/E 1 Output 3
96	M/E 1 Output 4
97	Unused
98	Unused
99	M/E 2 Output 1
100	M/E 2 Output 2
101	M/E 2 Output 3
102	M/E 2 Output 4
103	Unused
104	Unused
105	M/E 3 Output 1
106	M/E 3 Output 2
107	M/E 3 Output 3
108	M/E 3 Output 4
109	Unused
110	Unused
111	Pgm-Pst Output 1
112	Pgm-Pst Output 2
113	Pgm-Pst Output 3
114	Pgm-Pst Output 4
115	Unused
116	Unused
117	DVE 2 Output 1
118	DVE 2 Output 2
119	DVE 2 Output 3
120	DVE 2 Output 4
121	Store 1
122	Store 2
123	Store 3

Source IDs	Kahuna
124	Store 4
125	Store 5
126	Store 6
127	Store 7
128	Store 8

- 12 In the **Layouts** tab, create layouts and assign logical sources created in [step 11](#) to monitors that can display text (e.g. UMD) and alarms (e.g. UMD, video, text alarm).



- 13 On the **File** menu, click **Save**.
- 14 On the **Configure** menu, point to **Database**, and then click **Export** to export the database to your multiviewer.
- 15 On the multiviewer, load the layout containing the monitors assigned to dynamic text and tallies coming from the Kahuna switcher.  
You should see source names and tallies from the Kahuna switcher on the monitor wall.

## Kayak Production Switcher

A multiviewer can receive dynamic source names and tally information from Thomson Grass Valley production switchers that support the ACOS protocol, including the KayakDD, Kayak HD/SD, DD35, and XtenDD HD/SD series. The procedures below describe how to set up a multiviewer to interface with these Thomson Grass Valley switchers, for which the generic name *Kayak switcher* will be used.

---

**Note:** The on-air tally feature was introduced in version 6.9.3 of the ACOS protocol, which is only available with the Kayak series of Thomson Grass Valley production switchers. Other features such as retrieving dynamic source or destination names, and changing crosspoints are available on all ACOS-enabled production switchers.

---

### Configuring the Kayak Switcher

Once you have established a serial connection between the switcher and your multiviewer, you will need to enable the ACOS protocol on the switcher's serial port by using the Sidepanel software.

#### To set up the Kayak switcher

- 1 Physically connect one end of an RJ-45 straight cable to the multiviewer's RS-422 port.



- Using a DE-9S-to-RJ-45 crossover adapter (Grass Valley part no. 1792-3700-100), connect the other end of the cable to one of the RS-422 control ports on the Kayak switcher. The illustration below shows the location of the RS-422 ports on a 4RU Kayak HD switcher. The RS-422 ports (highlighted) are numbered 1 – 8, from top to bottom. Refer to your switcher's *Installation and Service Manual* for more details.<sup>5</sup>

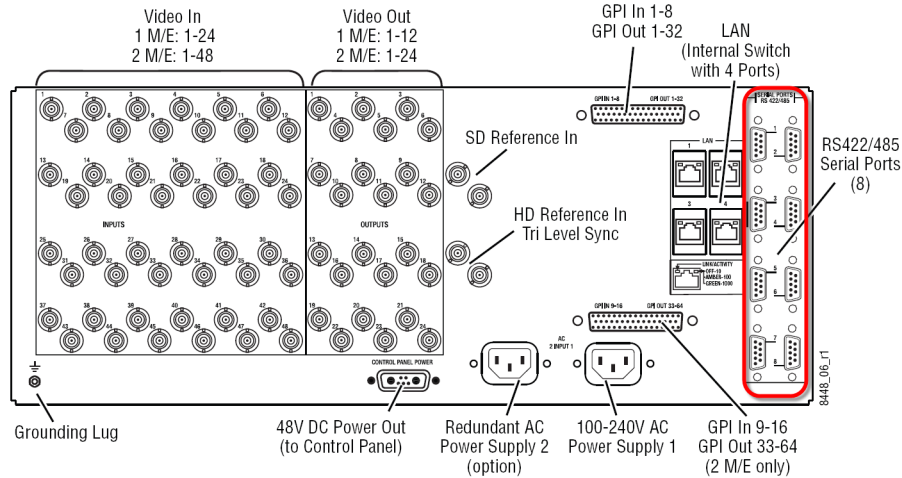

The Kayak switcher's 8 control ports have DE-9 female connectors with the following pinout:

Pin	Signal
1 and 9	Chassis Ground
2	RX-
3	TX+
7	RX+
8	TX-
4 and 6	Signal Ground

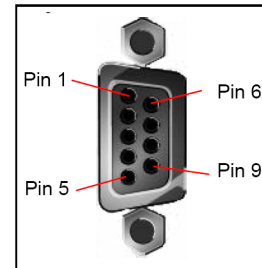

**Note:** See [RS-422 Connection Diagram](#), on page 25 for pinouts on the multiviewer.

- Install the Sidepanel software (available on the Kayak Software CD) on a PC or laptop, if you have not already done so. (Refer to your switcher's Release Notes for installation instructions.)
- Launch the Sidepanel software, and navigate to the **Install > E-Box** menu.
- Click the **Router** tab.
- Under **Automation Control 1**, select the appropriate serial port (i.e. the one to which the multiviewer is connected) and the protocol type (only "acos\_vxxx" should be available).

<sup>5</sup> Manuals and Release Notes for all Grass Valley production switchers are available here: [http://www.grassvalley.com/docs/all\\_switchers.html#manuals](http://www.grassvalley.com/docs/all_switchers.html#manuals)

This completes the configuration required on the switcher. The ACOS protocol is now enabled on the serial port used for the connection between the switcher and the multiviewer. The multiviewer system will be able to send commands to the switcher, and the switcher will respond accordingly.

### Configuring the Multiviewer

For your multiviewer to receive tally status, input names and output names from a Kayak switcher, and to display the switcher's contribution on the monitor wall as visual tally and dynamic text information, you need to configure your multiviewer's Kayak serial tally service, by performing the following tasks in XEdit:

- set up the communication parameters for the serial connection;
- configure logical sources by assigning input names, output names, and tally status from the switcher to the logical sources' text or alarm levels;
- assign alarm and text levels from logical sources to layout elements such as UMDs or alarm monitors.

### Establishing serial communication between the Kayak switcher and the multiviewer

#### To set up the multiviewer's communication parameters

- 1 Open XEdit.
- 2 In the main window, click the **System** tab, and then click **Description/Calibrations** on the second-level tab bar. The main pane displays the System hierarchical list, and the **Tools** pane displays the equipment library when the root of the System list is selected.
- 3 Drag the **Kayak** production switcher device from the equipment library onto the root of the System hierarchical list. Alternatively, right-click the list root, and then click **Insert Kayak** on the menu.

A window appears, prompting you for a device identifier.



- 4 Type a name for the Kayak production switcher, and then click **OK**.
- 5 Click the **Interconnects** tab.
- 6 Position the pointer over the multiviewer icon, then click and drag towards the Kayak production switcher icon.

A line representing the connection between the multiviewer and the device appears.

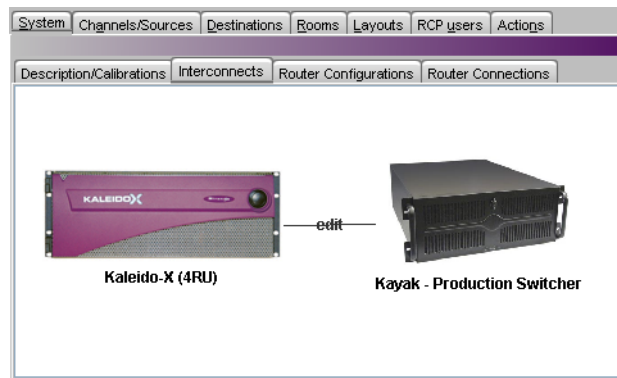

Connection between the multiviewer and the device

- 7 Click the connection line between multiviewer and device.
- 8 In the **Properties** pane, select the appropriate element from the **RS-422 communication port list**.

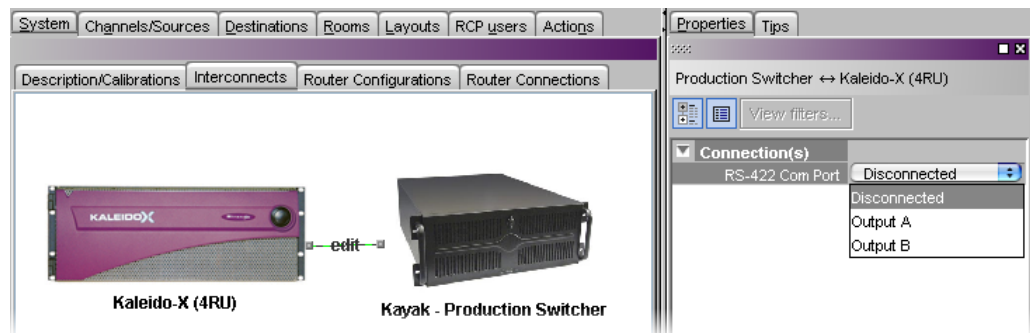

Depending on the multiviewer model, the available RS-422 ports are designated as follows:

KMV-3901/3911	RS-422
Kaleido-X16	Port 1, and Port 2
Kaleido-X (14RU)	Frame A – Output A, B, and C; Frame B – Output A, B, and C
Kaleido-X (7RU)	Output A, B, C, and D
Kaleido-X (4RU)	Output A, and B
Kaleido-MX	Output A, and B Note: The Kaleido-MX (1RU) 16×4 model has only one RS-422 port, which is physically connected to output card A.
Kaleido-Modular-X	Output A, and B Note: KMX-3901-OUT output cards with a single rear connector panel (KMX-3901-OUT-D-3+SRP) do not have RS-422 ports. To support a serial device, your Kaleido-Modular-X system must have at least one output card with a double rear connector panel (KMX-3901-OUT-D-3DRP).

- 9 In the **Interconnects** tab, click the **Kayak** production switcher icon.

10 In the **Properties** pane, set the serial communications properties for the Kayak device as follows:

Baud Rate	38400
Data Bits	8
Parity	NONE
Stop bits	1

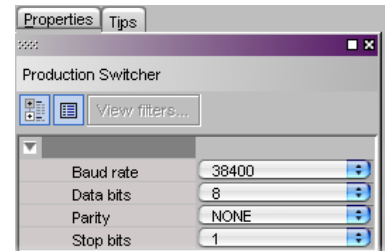

### Assigning Kayak tallies, input names, and output names to logical sources

#### To configure your logical sources

- In the **Channels/Sources** tab, configure logical sources using text sources and system tallies from the Kayak's serial interface.

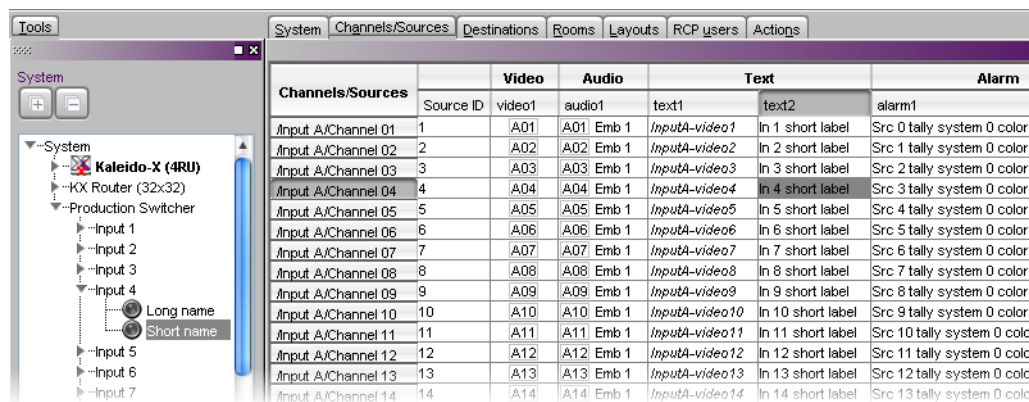

#### Notes

- Kayak devices provide up to 512 text sources, and up to 256 × 5 system tally sources.
- The current version of the XtenDD HD/SD switchers software does not provide tally sources.
- DD35 and the Kayak series switchers only provide RED (On Air) tally sources. This is a limitation in the current version (6.9.3) of the ACOS protocol.
- Refer to the table below for a list of valid sources, depending on your switcher model, and their meaning in the context of the ACOS protocol.

Input Number	DD35	XtenDD HD	XtenDD SD	KayakDD	Kayak SD/HD
0x00	BLACK	BLACK	BLACK	BLACK	BLACK
0x01..0x60	Input1...62 (0x01..0x3E)	Input 1..90 (0x01..0x5A)	Input 1..90 (0x01..0x5A)	Input 1..32 (0x01..0x20)	Input 1..96 (0x01..0x60)
0x80	VideoStore				

Input Number	DD35	XtenDD HD	XtenDD SD	KayakDD	Kayak SD/HD
0x81	Montage processor 1				
0x82	Montage processor 2				
0x85	DVX1	DVX1	DVX1		
0x86	DVX2	DVX2	DVX2		
0x87	DVX3	DVX3	DVX3		
0x88	DVX4	DVX4	DVX4		
0x89		RamRec1	RamRec1	RamRec1	RamRec1
0x8A		RamRec2	RamRec2	RamRec2	RamRec2
0x8B		RamRec3	RamRec3	RamRec3	RamRec3
0x8C		RamRec4	RamRec4	RamRec4	RamRec4
0x8D					RamRec5
0x8E					RamRec6
0x90	ColorBGD1	ColorBGD1	ColorBGD1	ColorBGD1	ColorBGD1
0x91	ColorBGD2	ColorBGD2		ColorBGD2	ColorBGD2
0x92	ColorBGD3			ColorBGD3	ColorBGD3
0x98			ColorBGD ME		
0x99					ColorBGDTest
0xA0	PP-Main	PP-Main	PP-Main	PP A	PP A
0xA1	ME1-Main	ME1-Main	ME1-Main	M1 A	M1 A
0xA2	ME2-Main	ME2-Main	ME2-Main		M2 A
0xA3	ME3-Main	ME3-Main	ME3-Main		M3 A
0xA4					MEhA
0xA8			PP_UTIL_D		
0xA9			PP_UTIL_E		
0xAA			ME1_UTIL_D		
0xAB			ME1_UTIL_E		
0xAC			ME2_UTIL_D		
0xAD			ME2_UTIL_E		
0xAE			ME3_UTIL_D		
0xAF			ME3_UTIL_E		
0xB0	PP-PVW	PP-PVW	PP-PVW	PPp1	PPp1
0xB1	ME1-PVW	ME1-PVW	ME1-PVW	M1p1	M1p1
0xB2	ME2-PVW	ME2-PVW	ME2-PVW	M2p1	M2p1

Input Number	DD35	XtenDD HD	XtenDD SD	KayakDD	Kayak SD/HD
0xB3	ME3-PVW	ME3-PVW	ME3-PVW	M3p1	M3p1
0xB4					Mhp1
0xB8		VideoStore1	VideoStore1		
0xB9		VideoStore2	VideoStore2		
0xBA		VideoStore3	VideoStore3		
0xBB		VideoStore4	VideoStore4		
0xBC		VideoStore5	VideoStore5		
0xBD		VideoStore6	VideoStore6		
0xC0					PP C
0xC1	Layer ME1				PP D
0xC2	Layer ME2				M1 C
0xC3	Layer ME3				M1 D
0xC4					M2 C
0xC5					M2 D
0xC6					M3 C
0xC7					M3 D
0xC8		PPKey	PPKey		
0xC9		ME1Key	ME1Key		
0xCA		ME2Key	ME2Key		
0xCB		ME3Key	ME3Key		
0xD0	PP Clean	PP Clean	PP Clean	PP B (PP Clean)	PP B
0xD1	ME1 Clean	ME1 Clean	ME1 Clean	M1 B (ME1 Clean)	M1 B
0xD2	ME2 Clean	ME2 Clean	ME2 Clean		M2 B
0xD3	ME3 Clean	ME3 Clean	ME3 Clean		M3 B
0xD4		PP UtilA	PP UtilA	PPp2 (PP Clean Preview)	MEh B
0xD5		PP UtilB	PP UtilB		
0xD6		PP UtilC	PP UtilC		
0xD7		ME1 UtilA	ME2 UtilA	M1p2 (ME1 Clean Preview)	
0xD8		ME1 UtilB	ME1 UtilB		PPp2
0xD9		ME1 UtilC	ME1 UtilC		M1p2

Input Number	DD35	XtenDD HD	XtenDD SD	KayakDD	Kayak SD/HD
0xDA		ME2 UtilA	ME2 UtilA		M2p2
0xDB		ME2 UtilB	ME2 UtilB		M3p2
0xDC		ME2 UtilC	ME2 UtilC		Mhp2
0xDD		ME3 UtilA	ME3 UtilA		
0xDE		ME3 UtilB	ME3 UtilB		
0xDF		ME3 UtilC	ME3 UtilC		
0xE0..0xEF	Virtual Input 00...15	Virtual Input 00...15	Virtual Input 00...15	Virtual Input 00...15	Virtual Input 00...15
0xF0	WHITE	WHITE	WHITE	WHITE	WHITE

## Configuring layout elements

### To configure layout elements

- 1 In the **Layouts** tab, create layouts and assign the logical sources you configured (see [Assigning Kayak tallies, input names, and output names to logical sources](#), on page 408) to monitors that can display text (e.g. UMD) or alarms (e.g. UMD, video, text alarm status).
- 2 Depending on your purposes, assign the appropriate text or alarm levels to specific components within the monitors (e.g. assign an alarm level to a tally component in a UMD, or a text level to the UMD text component).

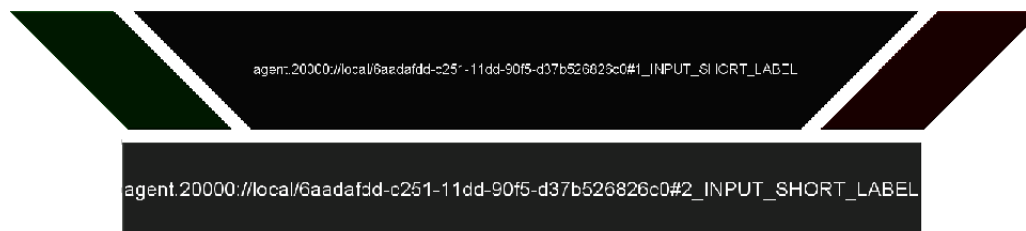

- 3 On the **File** menu, click **Save**.
- 4 On the **Configure** menu, point to **Database**, and then click **Export** to export the database to your multiviewer.

On the monitor wall, you can now load the layout containing the monitors that were assigned dynamic text and tallies provided by the Kayak switcher. Input and output names, as well as tally status from the Kayak switcher will be visible on the wall. Any changes made by the switcher's operator will be immediately reflected.

## Kayenne Production Switcher

A multiviewer can receive dynamic source names and tally information from a Grass Valley Kayenne Video Production Center. The procedures below describe how to set up a multiviewer to interface with this family of production switchers.

## Configuring the Kayenne Switcher

To establish a serial connection between the switcher and your multiviewer, you need to identify the serial port you wish to use for tally contribution in the switcher's *Engineering Setups*, by using the Kayenne touch screen menu panel or the Kayenne Menu application.

### To set up the Kayenne switcher

- 1 Physically connect one end of an RJ-45 straight cable to the multiviewer's RS-422 port.
- 2 Using a DE-9S-to-RJ-45 crossover adapter (Grass Valley part no. 1792-3700-100), connect the other end of the cable to one of the 8 RS-422 control ports on the Kayenne Video Processor Frame. The illustration below shows the location of the RS-422 ports on a 4RU Kayenne frame. The RS-422 ports (highlighted) are numbered 1 – 8, from top to bottom.

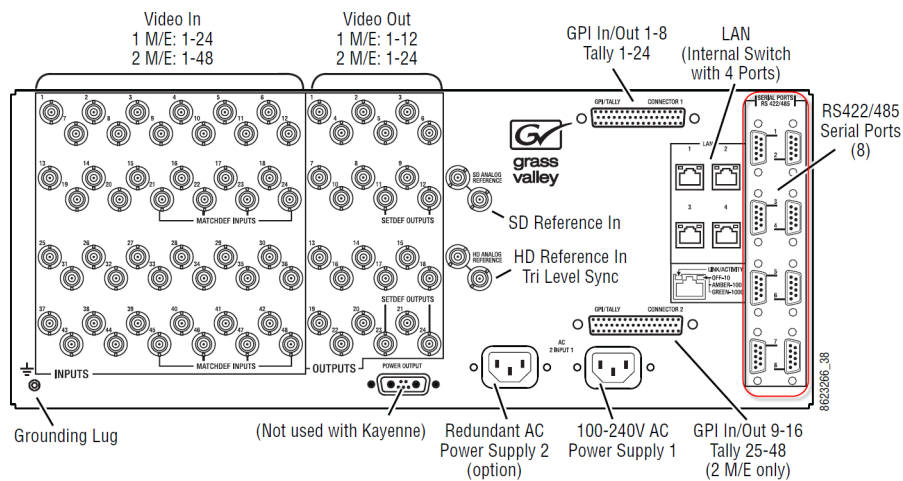

The 8 RS-422 control ports at the back of a Kayenne Video Processor frame have DE-9 female connectors. When any of them is designated as the tally contribution port, it is automatically configured with the following pinout:

Pin	Signal
1 and 9	Chassis Ground
2	RX-
3	TX+
7	RX+
8	TX-
4 and 6	Signal Ground

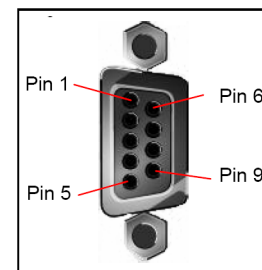

**Note:** See [RS-422 Connection Diagram](#), on page 25 for pinouts on the multiviewer's side.

- 3 On the Kayenne touch screen menu panel, touch the **Eng Setup** menu button, the **Ports & Devices** category button, and then the **Serial Tally Ports** tab. The **Serial Tally Ports** menu appears.
- 4 In the port selection area, touch the port you wish to use as the tally contribution port.



- 5 In the **Baud Rate / Parity** area, touch **115.2k**, and **None**.

This sets the baud rate to 115,200 and the parity to None.

Assuming the required sources and outputs have been defined, this completes the configuration required on the switcher. The multiviewer system will be able to send commands to the switcher, and the switcher will respond accordingly. Refer to the *Kayenne Installation and Service Manual* for more details.<sup>6</sup>

## Configuring the Multiviewer

For your multiviewer to receive tally status, source names and output names from a Kayenne switcher, and to display the switcher's contribution on the monitor wall as visual tally and dynamic text information, you need to configure your multiviewer's Kayenne serial tally service, by performing the following tasks in XEdit:

- set up the communication parameters for the serial connection;
- configure logical sources by assigning input names, output names, and tally status from the switcher to the logical sources' text or alarm levels;
- assign alarm and text levels from logical sources to layout elements such as UMDs or alarm monitors.

## Establishing serial communication between the Kayenne switcher and the multiviewer

### To set up the multiviewer's communication parameters

- 1 Open XEdit.
- 2 In the main window, click the **System** tab, and then click **Description/Calibrations** on the second-level tab bar. The main pane displays the System hierarchical list, and the **Tools** pane displays the equipment library when the root of the System list is selected.
- 3 Drag the **Kayenne** production switcher device from the equipment library onto the root of the System hierarchical list. Alternatively, right-click the list root, and then click **Insert Kayenne** on the menu.

A window appears, prompting you for a device identifier.



- 4 Type a name for the Kayenne production switcher, and then click **OK**.
  - 5 Click the **Interconnects** tab.
  - 6 Position the pointer over the multiviewer icon, then click and drag towards the Kayenne production switcher icon.
- A line representing the connection between the multiviewer and the device appears.

---

6. Manuals and Release Notes for all Grass Valley production switchers are available here:  
[http://www.grassvalley.com/apps/doc\\_prodlst?super=broadcast&set=switchers](http://www.grassvalley.com/apps/doc_prodlst?super=broadcast&set=switchers)

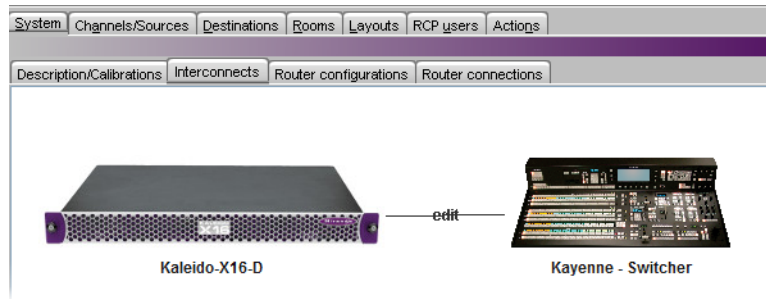

- 7 Click the connection line between multiviewer and device.
- 8 In the **Properties** pane, select the appropriate serial port from the **RS-422 communication port** list.

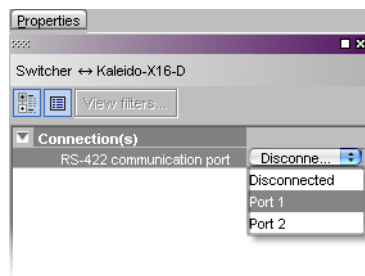

Depending on the multiviewer model, the available RS-422 ports are designated as follows:

KMV-3901/3911	RS-422
Kaleido-X16	Port 1, and Port 2
Kaleido-X (14RU)	Frame A – Output A, B, and C; Frame B – Output A, B, and C
Kaleido-X (7RU)	Output A, B, C, and D
Kaleido-X (4RU)	Output A, and B
Kaleido-MX	Output A, and B Note: The Kaleido-MX (1RU) 16×4 model has only one RS-422 port, which is physically connected to output card A.
Kaleido-Modular-X	Output A, and B Note: KMX-3901-OUT output cards with a single rear connector panel (KMX-3901-OUT-D-3+SRP) do <i>not</i> have RS-422 ports. To support a serial device, your Kaleido-Modular-X system must have at least one output card with a double rear connector panel (KMX-3901-OUT-D-3DRP).

- 9 In the **Interconnects** tab, click the **Kayenne** production switcher icon.

- 10 In the **Properties** pane, set the serial communications properties for the Kayenne device as follows:

Baud Rate	115200
Data Bits	8
Parity	NONE
Stop bits	1

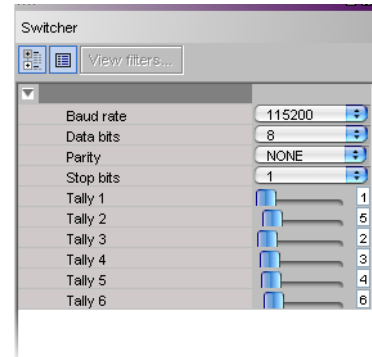

- 11 Set the appropriate output numbers to use for tally calculation, based on your switcher's configuration.

The current version of the Kaleido-X software supports monitoring of up to 6 tallies from a Kayenne Video Processor Frame. By default, in XEdit, **Tally 1** corresponds to the Kayenne's output 1 (which typically carries the *Program* signal), and **Tally 2** corresponds to the Kayenne's output 5 (typically the *Preview* signal). The following table lists the default output assignments on a Kayenne Video Processor Frame. Refer to the *Kayenne Installation and Service Manual* for more details.<sup>7</sup>

ME A		ME B		ME C		ME D	
Output #	Signal	Output #	Signal	Output #	Signal	Output #	Signal
1	Pgm A	13	ME1 A	25	ME2 A	37	ME3 A
2	Pgm B	14	ME1 B	26	ME2 B	38	ME3 B
3	Pgm C	15	ME1 C	27	ME2 C	39	ME3 C
4	Pgm D	16	ME1 D	28	ME2 D	40	ME3 D
5	Pgm pA	17	ME1 pA	29	ME2 pA	41	ME3 pA
6	Pgm p2	18	ME1 p2	30	ME2 p2	42	ME3 p2
7	Aux 1	19	Aux 4	31	Aux 8	43	Aux 14
8	Aux 1	20	Aux 4	32	Aux 9	44	Aux 15
9	Aux 2	21	Aux 5	33	Aux 10	45	Aux 16
10	Aux 2	22	Aux 6	34	Aux 11	46	Aux 17
11	Aux 3	23	Aux 7	35	Aux 12	47	Aux 18
12	Aux 3	24	Sw Pvw	36	Aux 13	48	Aux 19

### Assigning Kayenne tallies, input names, and output names to logical sources

The Kayenne contribution tally protocol provides information on up to 96 external sources, up to 4 eDPM video/key pairs, up to 6 image store outputs, up to 48 programmable switcher outputs, up to 2 complete operator suites with the associated alternative source names, and a few more signals from the Kayenne Video Processor Frame. In XEdit's **Channels/Sources** tab, configure logical sources using text sources and system tallies from

7. Manuals and Release Notes for all Grass Valley production switchers are available here:  
[http://www.grassvalley.com/docs/all\\_switchers.html#manuals](http://www.grassvalley.com/docs/all_switchers.html#manuals)

the Kayenne's serial interface. You will find these elements by expanding the filtered system list that appears in the **Tools** pane.

**To configure your logical sources**

- 1 In the **Channels/Sources** tab, add the required number of text and alarm levels for your purposes (see [Creating and Configuring Logical Sources](#), on page 178).  
 You may, for example, add one text level to monitor source labels from the Kayenne switcher, and two alarm levels to monitor Program and Preview tallies.
- 2 Click a cell that corresponds to the appropriate *text* level of a logical source.
- 3 In the filtered System list, navigate to the text element you wish to monitor, and drag it onto the selected cell.

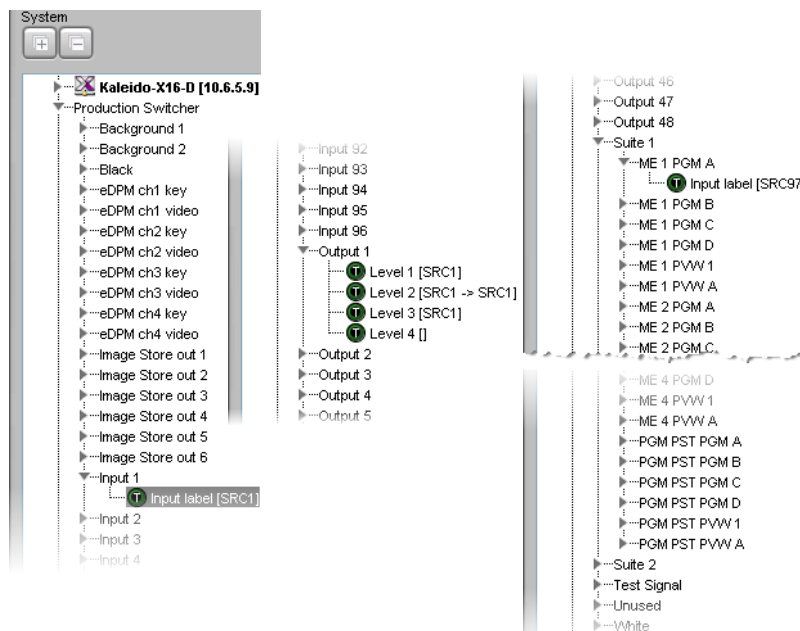

*Kayenne elements available from the filtered System list, for assignment to text levels in the sources table*

In the case of the Kayenne Output 1 to Output 48, from which elements can be assigned to text levels in your multiviewer's logical sources, the Kaleido-X software supports 4 display modes for the labels:

Level 1	The label represents the initial background feed.
Level 2	The label represents the initial and the previous background feed
Level 3	The label represents the previous background feed
Level 4	The label represents the current background feed (not yet supported)

All other Kayenne signals represented in the filtered System list, are associated with a single Input label.

- 4 If your logical sources include more text levels to be associated with the Kayenne switcher, then repeat [step 2](#) – [step 3](#) for the current logical source's remaining text levels.
- 5 Click a cell that corresponds to the appropriate *alarm* level of the current logical source.
- 6 In the filtered System list, navigate to the tally element you wish to monitor, and drag it onto the selected cell.

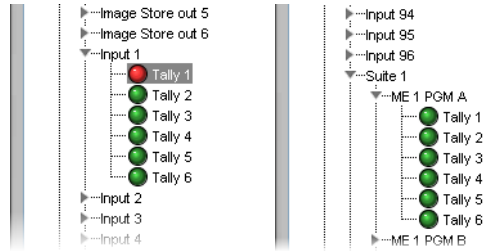

*Kayenne elements available from the filtered System list, for assignment to alarm levels in the sources table*

**Note:** In the case of a Kayenne system involving ISO recorders controlled via GPI, when a GPI command is used to take a recorder off air, related tallies may not be updated on the multiviewer side. In addition, the following Kayenne features are not supported:

- Pgm-Pst Look Ahead Preview (LAP) tallies (“Next On Air”)
- Bus tallies
- Tracing of upstream tally tributaries

- 7 If your logical sources include more alarm levels to be associated with the Kayenne switcher, then repeat [step 5](#) – [step 6](#) for the current logical source's remaining alarm levels.
- 8 Make corresponding assignments to other logical sources by incremental copy, if desired (see [Making Further Assignments by Incremental Copy](#), on page 189).

Text level based on dynamic labels from Kayenne sources

Alarm levels based on tallies from the Kayenne device

System	Channels/Sources	Destinations	Rooms	Layouts	RCP_users	Actions					
Channels/Sources		Source info		Video	Audio	Text		Alarm		Time code	
	#	Cat.	Name	video1	audio1	Video Format	Src Name	Loss	PGM	PVW	timecode1
INPUT 01	1		INPUT 01	01	01 Emb 1	01 Video format	1 - Input label	01 Video loss	Port 1 - tally 1	Port 1 - tally 2	01 Vid. TC
INPUT 02	2		INPUT 02	02	02 Emb 1	02 Video format	2 - Input label	02 Video loss	Port 2 - tally 1	Port 2 - tally 2	02 Vid. TC
INPUT 03	3		INPUT 03	03	03 Emb 1	03 Video format	3 - Input label	03 Video loss	Port 3 - tally 1	Port 3 - tally 2	03 Vid. TC
INPUT 04	4		INPUT 04	04	04 Emb 1	04 Video format	4 - Input label	04 Video loss	Port 4 - tally 1	Port 4 - tally 2	04 Vid. TC
INPUT 05	5		INPUT 05	05	05 Emb 1	05 Video format	5 - Input label	05 Video loss	Port 5 - tally 1	Port 5 - tally 2	05 Vid. TC
INPUT 06	6		INPUT 06	06	06 Emb 1	06 Video format	6 - Input label	06 Video loss	Port 6 - tally 1	Port 6 - tally 2	06 Vid. TC
INPUT 07	7		INPUT 07	07	07 Emb 1	07 Video format		07 Video loss			07 Vid. TC
INPUT 08	8		INPUT 08	08	08 Emb 1	08 Video format		08 Video loss			08 Vid. TC
INPUT 09	9		INPUT 09	09	09 Emb 1	09 Video format		09 Video loss			09 Vid. TC

- 9 On the **File** menu, click **Save**.  
Changes to the sources table are saved.

### Configuring layout elements

You can now assign the logical sources you previously configured (see [Assigning Kayenne tallies, input names, and output names to logical sources](#), on page 415) to monitors that

can display text (e.g. UMD) or alarms (e.g. UMD, video, text alarm status) in a layout. Depending on your purposes, you will assign the appropriate text or alarm levels to specific components within the monitors (e.g. assign an alarm level to tally components in a UMD, or a text level to the UMD text component).

#### To configure layout elements for dynamic text and tally reporting

- 1 Click the **Layouts** tab, and then open the layout you wish to configure.
- 2 In the **Tools** pane, select one of the logical sources you previously configured (see [Assigning Kayenne tallies, input names, and output names to logical sources](#), on page 415) from the filtered **Channels/Sources** list, and then drag it onto the appropriate monitor.
- 3 Repeat [step 2](#) until you have assigned all the sources you wish to monitor to the appropriate monitors in your layout.
- 4 Click the first UMD whose dynamic text and tally reporting behavior you wish to set, after unlocking the composite monitor that contains it if applicable (see [Unlocking a Composite Monitor](#), on page 295).
- 5 In the **Properties** pane, click the **Left tally source level** box, and then select the alarm level you wish to monitor.

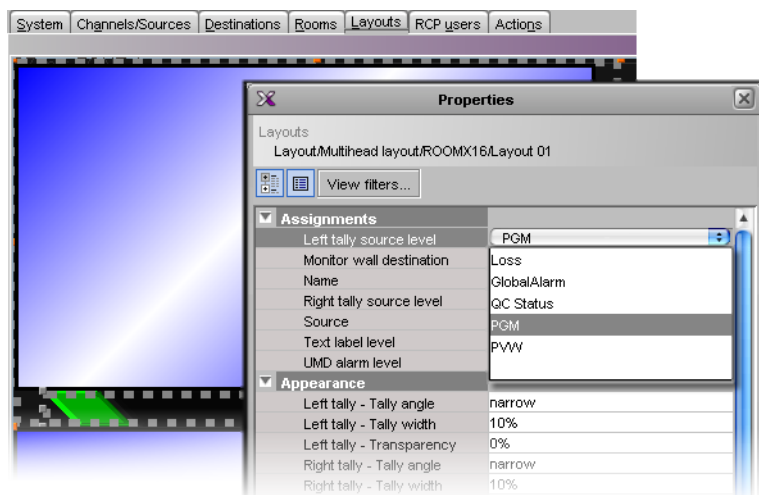

*Alarm level selection for the left tally in a UMD*

- 6 Click the **Right tally source level** box, and then select the appropriate alarm level, if applicable.
- 7 Click the **Text label level** box, and then select the text level you wish to monitor.

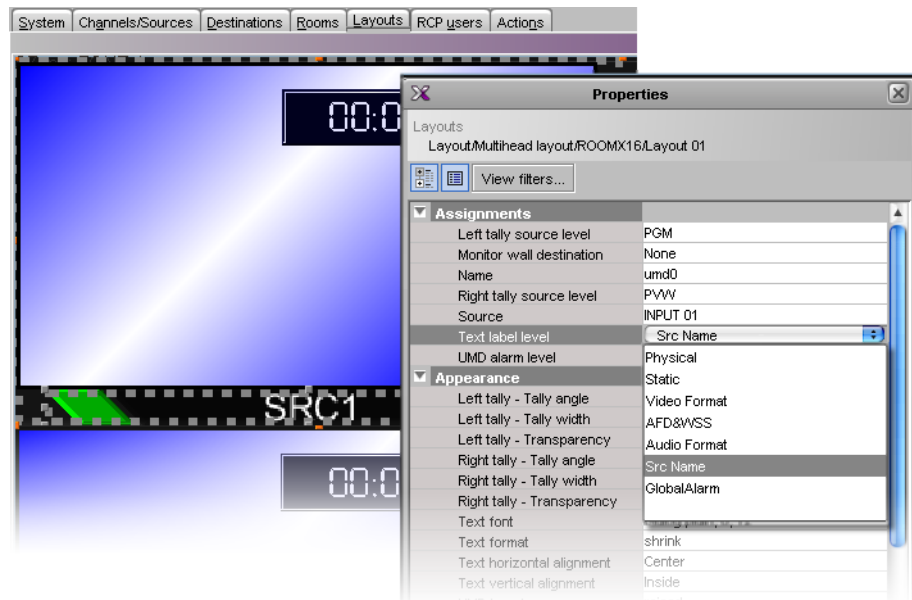

*Text level selection for the text label in a UMD*

- 8 Click outside the composite to lock it, if applicable.
- 9 Repeat [step 4](#) – [step 8](#) until you have configured all UMDs that are to display dynamic text and tally status when this layout is loaded on the monitor wall.
- 10 On the **File** menu, click **Save**.
- 11 If you are working in offline mode, then you must export the database to your multiviewer: on the **Configure** menu, point to **Database**, and then click **Export**.

On the monitor wall, you can now load the layout containing the monitors that were assigned dynamic text and tallies provided by the Kayenne switcher. Input or output names, as well as tally status from the Kayenne switcher will be visible on the monitor wall. Any changes made by the switcher's operator will be immediately reflected on the monitor wall.

## K-Frame Switchers

A multiviewer can receive dynamic source names and tally information from Grass Valley K-Frame production switchers, such as Kayenne K-Frame or Karrera K-Frame Video Production Center systems. The procedures below describe how to set up a multiviewer to interface with this family of production switchers.

### Configuring the K-Frame Switcher

To establish tally contribution from the switcher to your multiviewer, you need to identify the multiviewer as a tally client, by using the switcher's touch screen menu panel or the K-Frame Menu application.

#### To set up the K-Frame switcher

- 1 On the K-Frame touch screen menu panel, touch the **Eng Setup** menu button, the **Ports & Devices** category button, and then the **Tally Ports** tab.

The Tally Ports menu appears.

- 2 Enter your multiviewer's IP address in one of the two tally ports, and then touch the **Enable** button for the selected port.

The connection status indicator turns red, since the connection has yet to be established on the multiviewer side.

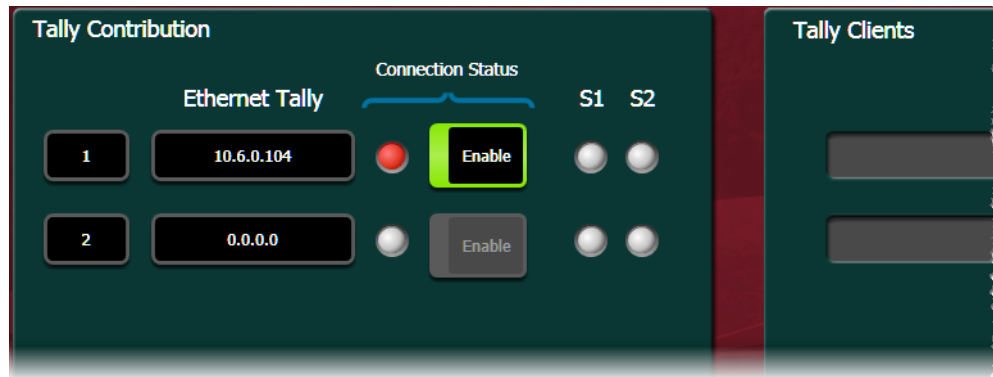

Assuming the required sources and outputs have been defined, this completes the configuration required on the switcher. The multiviewer system will be able to send commands to the switcher, and the switcher will respond accordingly. Refer to your switcher's *Installation and Service Manual* for more information.<sup>8</sup>

### Configuring the Multiviewer

For your multiviewer to receive tally status, and source names from a K-Frame switcher, and to display the switcher's contribution on the monitor wall as visual tally and dynamic text information, you need to configure your multiviewer's K-Frame tally service, by performing the following tasks in XEdit:

- set up the communication parameters;
- configure logical sources by assigning source names and tally status from the switcher, to the logical sources' text or alarm levels;
- assign alarm and text levels from logical sources to layout elements such as UMDs or alarm monitors.

### Establishing communication between the K-Frame switcher and the multiviewer

#### To set up the multiviewer's communication parameters

- 1 Open XEdit.
- 2 In the main window, click the **System** tab, and then click **Description/Calibrations** on the second-level tab bar. The main pane displays the System hierarchical list, and the **Tools** pane displays the equipment library when the root of the System list is selected.
- 3 Drag the **K-Frame** switcher device from the equipment library onto the root of the System hierarchical list. Alternatively, right-click the list root, and then click **Insert K-Frame** on the menu.

A window appears, prompting you for a device identifier.

<sup>8</sup> Manuals and Release Notes for all Grass Valley production switchers are available here:  
[http://www.grassvalley.com/apps/doc\\_prodlist?super=broadcast&set=switchers](http://www.grassvalley.com/apps/doc_prodlist?super=broadcast&set=switchers)





- 4 Type a name for the K-Frame production switcher, and then click **OK**.  
The device is added to your system configuration.
- 5 Click the **Interconnects** tab.
- 6 Position the pointer over the multiviewer icon, then click and drag towards the K-Frame production switcher icon.  
A line representing the connection between the multiviewer and the device appears.

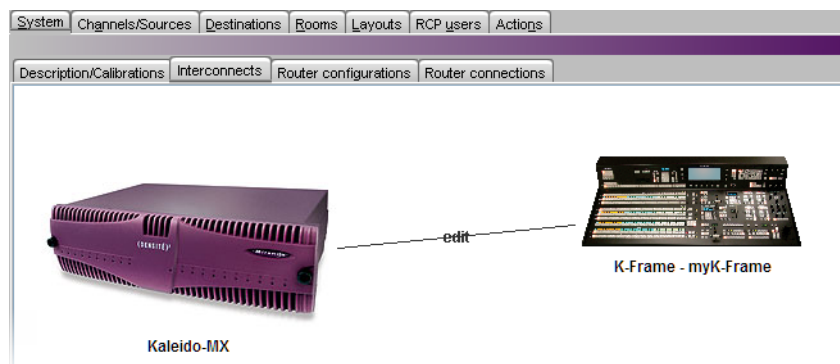

- 7 Click the connection line between multiviewer and device.
- 8 In the **Properties** pane, select **Network (TCP/IP)** from the **Transport type** list.

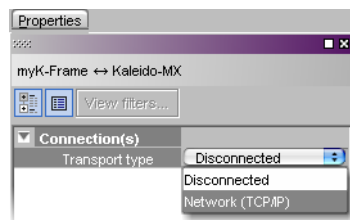

- 9 In the **Interconnects** tab, click the **K-Frame** production switcher icon.
- 10 In the **Properties** pane, enter the K-Frame switcher's IP address, and set the appropriate output numbers to use for tally calculation, based on your switcher's configuration.

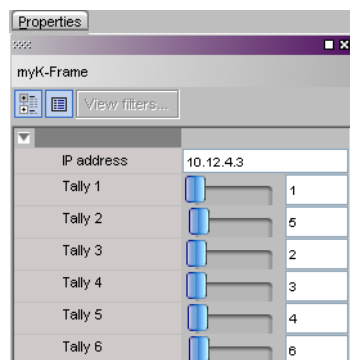

By default, in XEdit, **Tally 1** corresponds to the K-Frame switcher's output 1 (which typically carries the *Program* signal), and **Tally 2** corresponds to the K-Frame switcher's output 5 (typically the *Preview* signal).

- 11 On the **File** menu, click **Save**.

This establishes communication between the multiviewer and the switcher. On the touch screen menu panel (or in K-Frame Menu) you may notice that the status indicators turned green in the Tally Ports menu, and your multiviewer is now listed in the **Tally Clients** list.



### Assigning K-Frame tallies and input names to logical sources

The K-Frame contribution tally protocol provides information on up to 192 inputs, up to 96 outputs, the full set of fixed sources internal to the K-Frame system, and up to 2 complete operator suites. In XEdit's **Channels/Sources** tab, configure logical sources using input names and system tallies from the K-Frame. You will find these elements by expanding the filtered system list that appears in the **Tools** pane.

- For every input, 6 tallies, and 2 text labels (the *engineering name* and the *OLED name*) are available. When the OLED name is not defined for an input, both text labels contain the engineering name. A tally status indicates whether the input contributes to the output associated with the tally (see [step 10](#), under [Establishing communication between the K-Frame switcher and the multiviewer](#), on page 420). For example, if **Tally 1** has been configured to match *Output 1*, then the Tally 1 status of an input indicates whether this input contributes to Output 1.

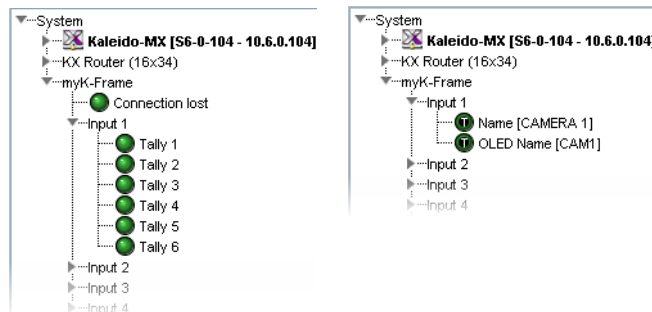

- For every physical output of the K-Frame, the (static) name of the output is available.

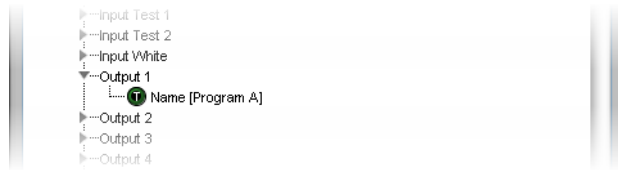

- Within the operator suites, 6 tally statuses are available for every video processing engine (VPE) output. The tally status indicates whether the VPE output contributes to the switcher output associated with the tally.

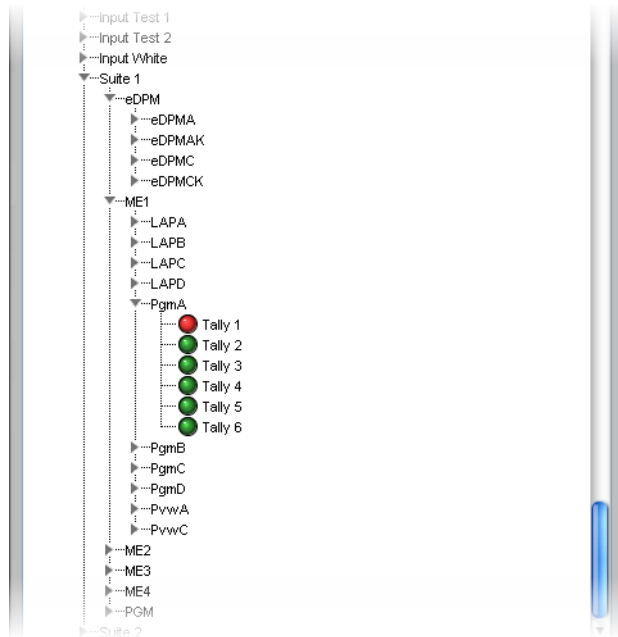

### To configure your logical sources

- 1 In the **Channels/Sources** tab, add the required number of text and alarm levels for your purposes (see [Creating and Configuring Logical Sources](#), on page 178).

You may, for example, add two text levels to monitor source labels from the K-Frame switcher, and two alarm levels to monitor Program and Preview tallies.

System Channels/Sources Destinations Rooms Layouts RCP users Actions											
Channels/Sources	Source info			Video	Audio	Text			Alarm		
	#	Cat.	Name	VIDEO	EMB 1	SRC Name	OLED name	Eng name	Loss	PGM	PVW
A01	1		A01	A01	A01 Emb 1	A01			A01 Video loss		
A02	2		A02	A02	A02 Emb 1	A02			A02 Video loss		
A03	3		A03	A03	A03 Emb 1	A03			A03 Video loss		
A04	4		A04	A04	A04 Emb 1	A04			A04 Video loss		
A05	5		A05	A05	A05 Emb 1	A05			A05 Video loss		
A06	6		A06	A06	A06 Emb 1	A06			A06 Video loss		
A07	7		A07	A07	A07 Emb 1	A07			A07 Video loss		
A08	8		A08	A08	A08 Emb 1	A08			A08 Video loss		
A09	9		A09	A09	A09 Emb 1	A09			A09 Video loss		
A10	10		A10	A10	A10 Emb 1	A10			A10 Video loss		

- 2 Click a cell that corresponds to the appropriate *text* level of a logical source.
- 3 In the filtered System list, navigate to the text element you wish to monitor, and drag it onto the selected cell.

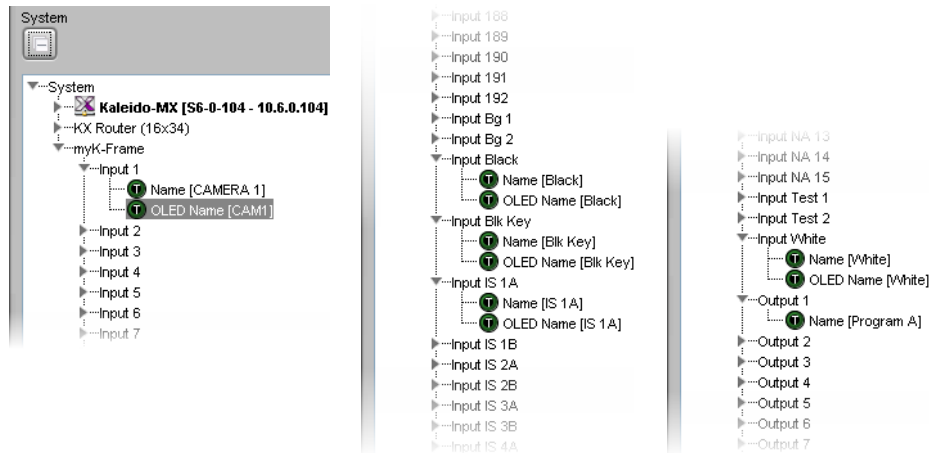

*K-Frame elements available from the filtered System list, for assignment to text levels in the sources table*

- 4 If your logical sources include more text levels to be associated with the switcher, then repeat [step 2](#) – [step 3](#) for the current logical source's remaining text levels.
- 5 Click a cell that corresponds to the appropriate *alarm* level of the current logical source.
- 6 In the filtered System list, navigate to the tally element you wish to monitor, and drag it onto the selected cell.

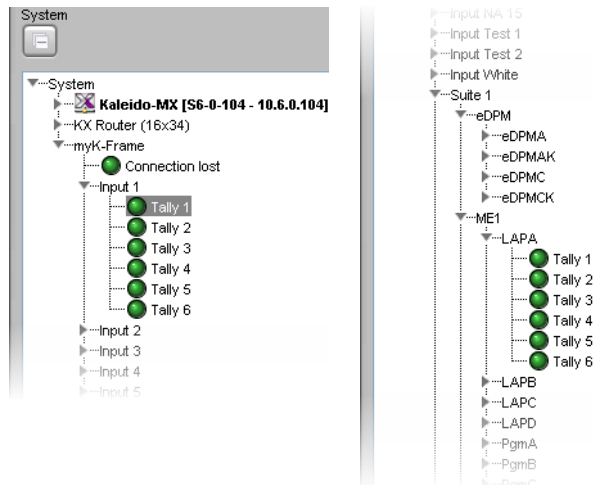

*K-Frame elements available from the filtered System list, for assignment to alarm levels in the sources table*

- 7 If your logical sources include more alarm levels to be associated with the K-Frame switcher, then repeat [step 5](#) – [step 6](#) for the current logical source's remaining alarm levels.
- 8 Make corresponding assignments to other logical sources by incremental copy, if desired (see [Making Further Assignments by Incremental Copy](#), on page 189).

Text levels based on dynamic K-Frame source labels      Alarm levels based on tallies from the K-Frame switcher

Channels/Sources		Source info		Video	Audio		Text		Alarm		
#	Cat.	Name	VIDEO	EMB 1	SRC Name	OLED name	Eng name	Loss	PGM	P/WV	
A01	1	A01	A01	A01 Emb 1	A01	Input 1 OLED name	Input 1 name	A01 Video loss	Input 1 tally 1	Input 1 tally 2	
A02	2	A02	A02	A02 Emb 1	A02	Input 2 OLED name	Input 2 name	A02 Video loss	Input 2 tally 1	Input 2 tally 2	
A03	3	A03	A03	A03 Emb 1	A03	Input 3 OLED name	Input 3 name	A03 Video loss	Input 3 tally 1	Input 3 tally 2	
A04	4	A04	A04	A04 Emb 1	A04	Input 4 OLED name	Input 4 name	A04 Video loss	Input 4 tally 1	Input 4 tally 2	
A05	5	A05	A05	A05 Emb 1	A05	Input 5 OLED name	Input 5 name	A05 Video loss	Input 5 tally 1	Input 5 tally 2	
A06	6	A06	A06	A06 Emb 1	A06	Input 6 OLED name	Input 6 name	A06 Video loss	Input 6 tally 1	Input 6 tally 2	
A07	7	A07	A07	A07 Emb 1	A07			A07 Video loss			
A08	8	A08	A08	A08 Emb 1	A08			A08 Video loss			
A09	9	A09	A09	A09 Emb 1	A09			A09 Video loss			
A10	10	A10	A10	A10 Emb 1	A10			A10 Video loss			

- On the **File** menu, click **Save**.  
Changes to the sources table are saved.

### Configuring layout elements

You can now assign the logical sources you previously configured (see [Assigning K-Frame tallies and input names to logical sources](#), on page 422) to monitors that can display text (e.g. UMD) or alarms (e.g. UMD, video, text alarm status) in a layout. Depending on your purposes, you will assign the appropriate text or alarm levels to specific components within the monitors (e.g. assign an alarm level to tally components in a UMD, or a text level to the UMD text component).

#### To configure layout elements for dynamic text and tally reporting

- Click the **Layouts** tab, and then open the layout you wish to configure.
- In the **Tools** pane, select one of the logical sources you previously configured (see [Assigning K-Frame tallies and input names to logical sources](#), on page 422) from the filtered **Channels/Sources** list, and then drag it onto the appropriate monitor.
- Repeat [step 2](#) until you have assigned all the sources you wish to monitor to the appropriate monitors in your layout.
- Click the first UMD whose dynamic text and tally reporting behavior you wish to set, after unlocking the composite monitor that contains it if applicable (see [Unlocking a Composite Monitor](#), on page 295).
- In the **Properties** pane, click the **Left tally source level** box, and then select the alarm level you wish to monitor.

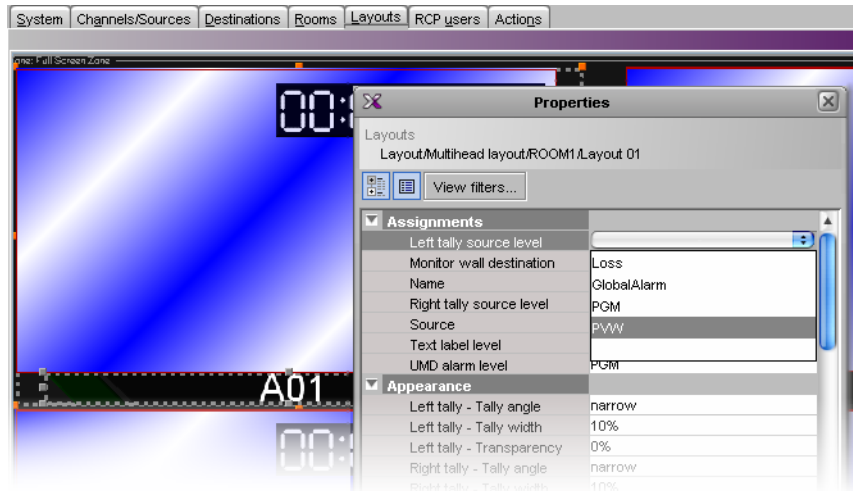

*Alarm level selection for the left tally in a UMD*

- 6 Click the **Right tally source level** box, and then select the appropriate alarm level, if applicable.
- 7 Click the **Text label level** box, and then select the text level you wish to monitor.

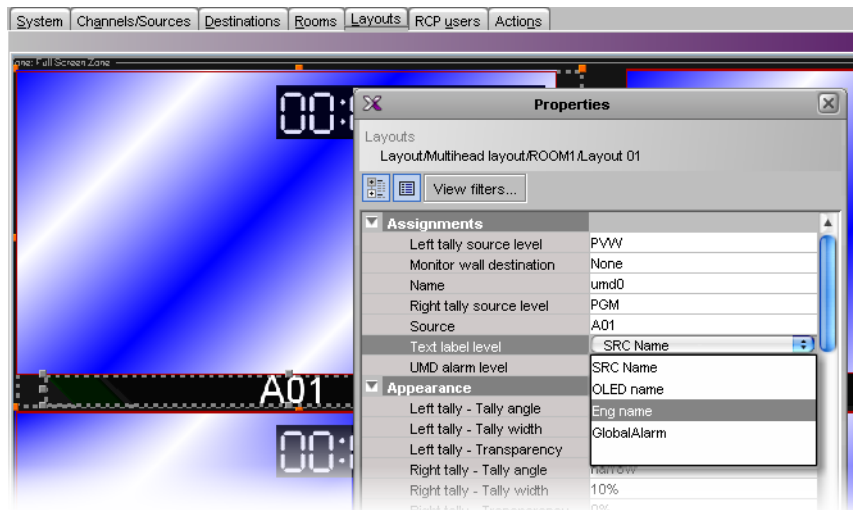

*Text level selection for the text label in a UMD*

- 8 Click outside the composite to lock it, if applicable.
- 9 Repeat [step 4](#) – [step 8](#) until you have configured all UMDs that are to display dynamic text and tally status when this layout is loaded on the monitor wall.
- 10 On the **File** menu, click **Save**.
- 11 If you are working in offline mode, then you must export the database to your multiviewer: on the **Configure** menu, point to **Database**, and then click **Export**.

On the monitor wall, you can now load the layout containing the monitors that were assigned dynamic text and tallies provided by the K-Frame switcher. Input names, and tally status from the switcher will be visible on the monitor wall. Any changes made by the switcher's operator will be immediately reflected on the monitor wall.

## Zodiak Production Switcher

A multiviewer can receive dynamic source names and tally information from a Grass Valley Zodiak Digital Production Switcher. The procedures below describe how to set up a multiviewer to interface with this family of production switchers.

### Configuring the Zodiak Switcher

To establish a serial connection between the switcher and your multiviewer, you need to identify the serial port you wish to use for tally contribution in the switcher's *Engineering Setups*, by using the Zodiak touch screen menu panel or the Zodiak Menu application. You also need to configure or take note of the communications settings and use the same values on the multiviewer's side. The procedure below is an example using the default values typically used on Grass Valley production switchers.

#### To set up the Zodiak switcher

- 1 Physically connect one end of an RJ-45 straight cable to the multiviewer's RS-422 port.
- 2 Using a DE-9S-to-RJ-45 crossover adapter (Grass Valley part no. 1792-3700-100), connect the other end of the cable to one of the 4 RS-422 control ports on the Zodiak Video Processor Frame. The illustration below shows the location of the RS-422 ports on a Zodiak frame. The RS-422 ports (highlighted) are labeled Serial 1 – 4 (J4 – J7).

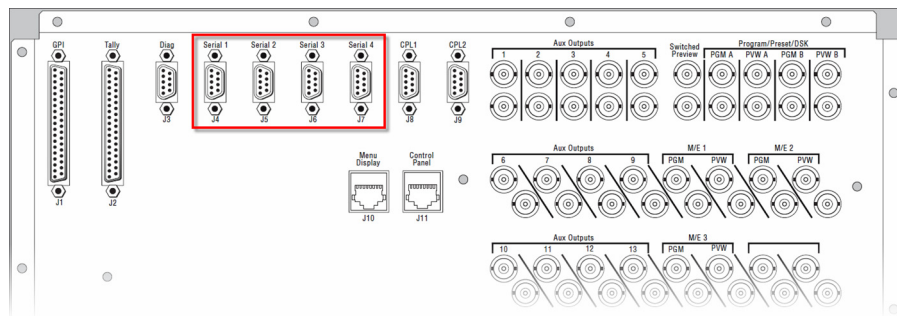

The 4 RS-422 control ports at the back of a Zodiak Video Processor frame have DE-9 female connectors with the following pinout:

Pin	Signal
1, 4, 6, and 9	Chassis ground
2	RX-
3	TX+
7	RX+
8	TX-

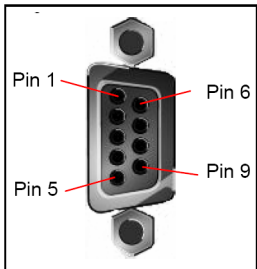

**Note:** See [RS-422 Connection Diagram](#), on page 25 for pinouts on the multiviewer's side.

- 3 From the Zodiak Home menu, touch the **Eng Setup** menu button, and then the **Ports & Devices** category button.

The **Physical Serial Port Assignment** menu appears.

- 4 In the port selection area, touch the port you wish to use as the tally contribution port.
- 5 In the **Baud Rate** area, touch **38.4k**.
- 6 In the **Parity** area, touch **None**.

This sets the baud rate to 38,400 and the parity to None.

Assuming the required sources and outputs have been defined, this completes the configuration required on the switcher. The multiviewer system will be able to send commands to the switcher, and the switcher will respond accordingly. Refer to the *Zodiak Installation and Service Manual* for more details.<sup>9</sup>

### Configuring the Multiviewer

For your multiviewer to receive tally status, source names and output names from a Zodiak switcher, and to display the switcher's contribution on the monitor wall as visual tally and dynamic text information, you need to configure your multiviewer's Zodiak serial tally service, by performing the following in XEdit:

- set up the communication parameters for the serial connection;
- configure logical sources by assigning input names, output names, and tally status from the switcher to the appropriate logical sources' text and alarm levels;
- assign alarm and text levels from logical sources to layout elements such as UMDs or alarm monitors.

### Establishing serial communication between the Zodiak switcher and the multiviewer

#### To set up the multiviewer's communication parameters

- 1 Open XEdit.
- 2 In the main window, click the **System** tab, and then click **Description/Calibrations** on the second-level tab bar. The main pane displays the System hierarchical list, and the **Tools** pane displays the equipment library when the root of the System list is selected.
- 3 Drag the **Zodiak** production switcher device from the equipment library onto the root of the System hierarchical list. Alternatively, right-click the list root, and then click **Insert Zodiak** on the menu.

A window appears, prompting you for a device identifier.



- 4 Type a name for the Zodiak production switcher, and then click **OK**.
- 5 Click the **Interconnects** tab.

---

9. Manuals and Release Notes for all Grass Valley production switchers are available here:  
[http://www.grassvalley.com/docs/all\\_switchers.html#manuals](http://www.grassvalley.com/docs/all_switchers.html#manuals)



- Position the pointer over the multiviewer icon, then click and drag towards the Zodiac production switcher icon.

A line representing the connection between the multiviewer and the device appears.

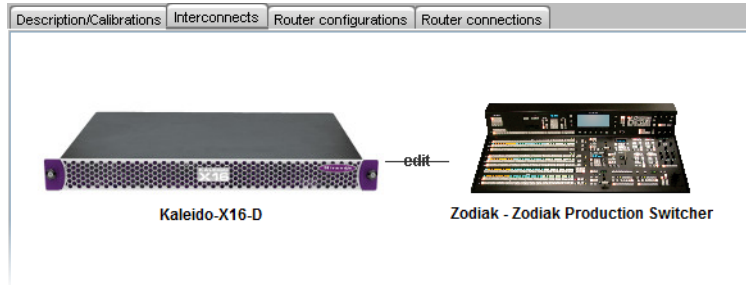

- Click the connection line between multiviewer and device.
- In the **Properties** pane, select the appropriate serial port from the **RS-422 communication port** list.

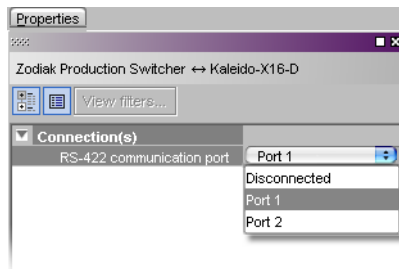

Depending on the multiviewer model, the available RS-422 ports are designated as follows:

KMV-3901/3911	RS-422
Kaleido-X16	Port 1, and Port 2
Kaleido-X (14RU)	Frame A – Output A, B, and C; Frame B – Output A, B, and C
Kaleido-X (7RU)	Output A, B, C, and D
Kaleido-X (4RU)	Output A, and B
Kaleido-MX	Output A, and B Note: The Kaleido-MX (1RU) 16 × 4 model has only one RS-422 port, which is physically connected to output card A.
Kaleido-Modular-X	Output A, and B Note: KMX-3901-OUT output cards with a single rear connector panel (KMX-3901-OUT-D-3+SRP) do <i>not</i> have RS-422 ports. To support a serial device, your Kaleido-Modular-X system must have at least one output card with a double rear connector panel (KMX-3901-OUT-D-3DRP).

- In the **Interconnects** tab, click the **Zodiak** production switcher icon.

In the **Properties** pane, the serial communications properties for the Zodiak device are the following, by default:

Baud Rate	38400
Data Bits	8
Parity	NONE
Stop bits	1

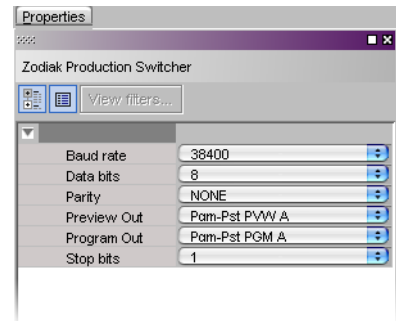

- 10 Set these properties to match the values used on the switcher.
- 11 Select the appropriate outputs to use for the **Preview Out** and **Program Out** tally calculation, based on your switcher's configuration.

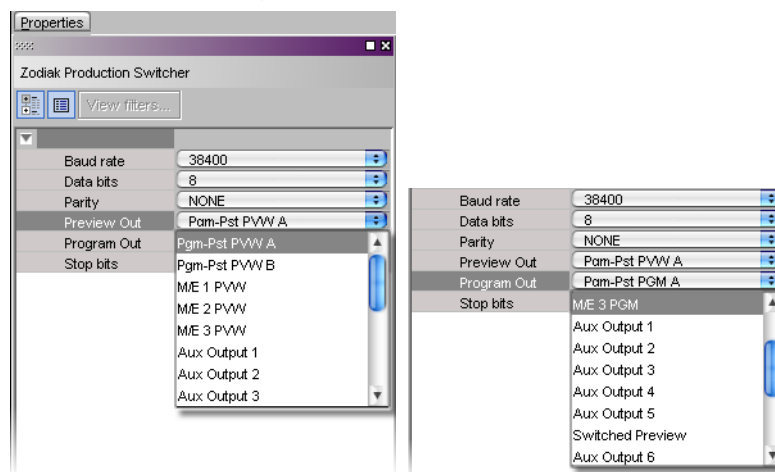

The current version of the Kaleido-X software supports monitoring of one Preview output and one Program output from any of the Zodiak switcher's physical or internal M/E units (Pgm-Pst PVW A, and B; M/E 1 PVW, M/E 2 PVW, M/E 3 PVW; Pgm-Pst PGM A, and B; M/E 1 PGM, M/E 2 PGM, M/E 3 PGM), from up to 13 Aux bus outputs, or from the additional switched preview output.

### Assigning Zodiak tallies, input names, and output names to logical sources

The Zodiak contribution tally protocol provides information on up to 128 external sources, up to 13 Aux bus outputs, and the switched preview output from the Zodiak Video Processor Frame, in addition to the Preview and Program outputs you selected (see [step 11](#), on [page 430](#), under [Establishing serial communication between the Zodiak switcher and the multiviewer](#)). In XEdit's **Channels/Sources** tab, configure logical sources using text sources and system tallies from the Zodiak's serial interface. You will find these elements by expanding the filtered system list that appears in the **Tools** pane.

#### To configure your logical sources

- 1 In the **Channels/Sources** tab, add the required number of text and alarm levels for your purposes (see [Creating and Configuring Logical Sources](#), on page 178).

You may, for example, add one text level to monitor source labels from the Zodiak switcher, and two alarm levels to monitor Program and Preview tallies.

- 2 Click a cell that corresponds to the appropriate *text* level of a logical source.
- 3 In the filtered System list, navigate to the text element you wish to monitor, and drag it onto the selected cell.

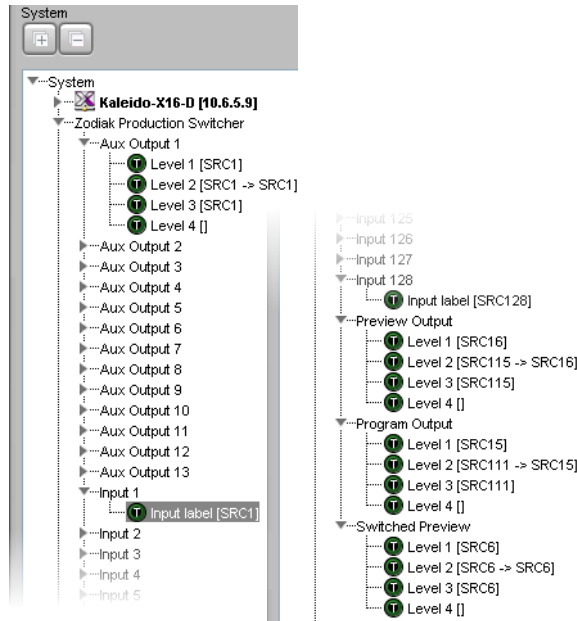

*Zodiak elements available from the filtered System list, for assignment to text levels in the sources table*

In the case of the Zodiak outputs (the Preview and Program Outputs you selected, Aux Output 1 to Aux Output 13, and the Switched Preview Output), from which elements can be assigned to text levels in your multiviewer's logical sources, the Kaleido-X software supports 4 display modes for the labels:

Level 1	The label represents the initial background feed.
Level 2	The label represents the initial and the previous background feed
Level 3	The label represents the previous background feed
Level 4	The label represents the current background feed (not yet supported)

The Zodiak external sources represented in the filtered System list (Input 1 to Input 128), are associated with a single Input label.

- 4 If your logical sources include more text levels to be associated with the Zodiak switcher, then repeat [step 2](#) – [step 3](#) for the current logical source's remaining text levels.
- 5 Click a cell that corresponds to the appropriate *alarm* level of the current logical source.
- 6 In the filtered System list, navigate to the tally element you wish to monitor, and drag it onto the selected cell.

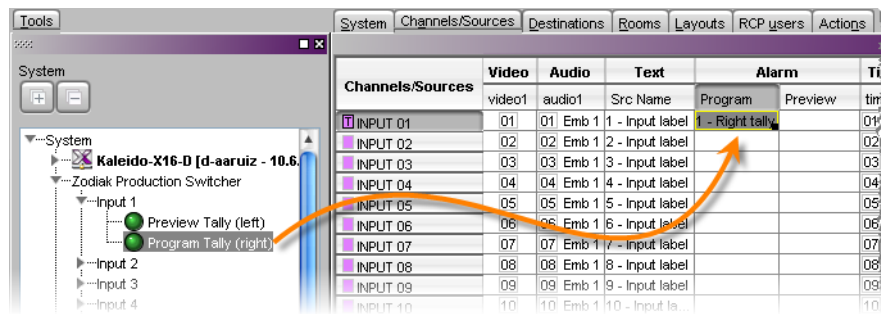

- If your logical sources include more alarm levels to be associated with the Zodiak switcher, then repeat [step 5](#) – [step 6](#) for the current logical source's remaining alarm levels.
- Make corresponding assignments to other logical sources by incremental copy, if desired (see [Making Further Assignments by Incremental Copy](#), on page 189).

Text level based on dynamic labels from Zodiak sources      Alarm levels based on tallies from the Zodiak device

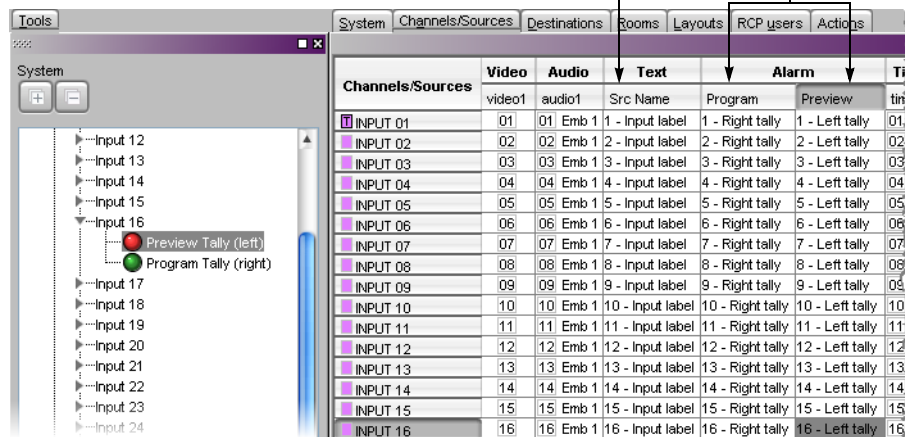

- On the **File** menu, click **Save**.  
Changes to the sources table are saved.

### Configuring layout elements

You can now assign the logical sources you previously configured to monitors that can display text (e.g. UMD) or alarms (e.g. UMD, video, text alarm status) in a layout. Depending on your purposes, you will assign the appropriate text or alarm levels to specific components within the monitors (e.g. assign an alarm level to tally components in a UMD, or a text level to the UMD text component).

#### To configure layout elements for dynamic text and tally reporting

- Click the **Layouts** tab, and then open the layout you wish to configure.
- In the **Tools** pane, select one of the logical sources you previously configured (see [Assigning Zodiak tallies, input names, and output names to logical sources](#), on page 430) from the filtered **Channels/Sources** list, and then drag it onto the appropriate monitor.
- Repeat [step 2](#) until you have assigned all the sources you wish to monitor to the appropriate monitors in your layout.

- 4 Click the first UMD whose dynamic text and tally reporting behavior you wish to set, after unlocking the composite monitor that contains it if applicable (see [Unlocking a Composite Monitor](#), on page 295).
- 5 In the **Properties** pane, click the **Left tally source level** box, and then select the alarm level you wish to monitor.

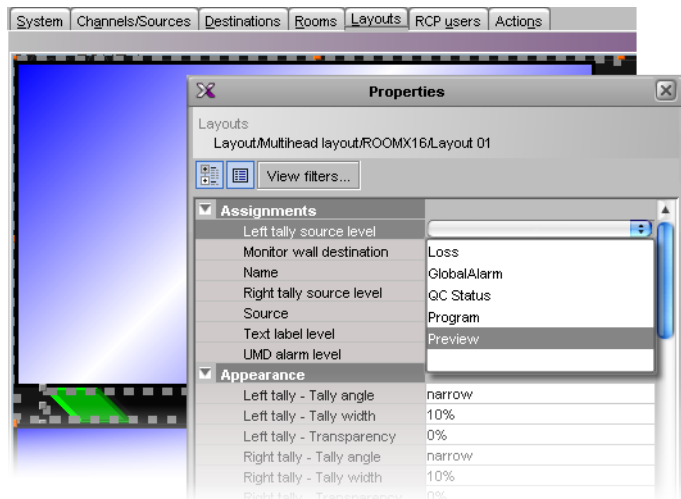

*Alarm level selection for the left tally in a UMD*

- 6 Click the **Right tally source level** box, and then select the appropriate alarm level, if applicable.
- 7 Click the **Text label level** box, and then select the text level you wish to monitor.

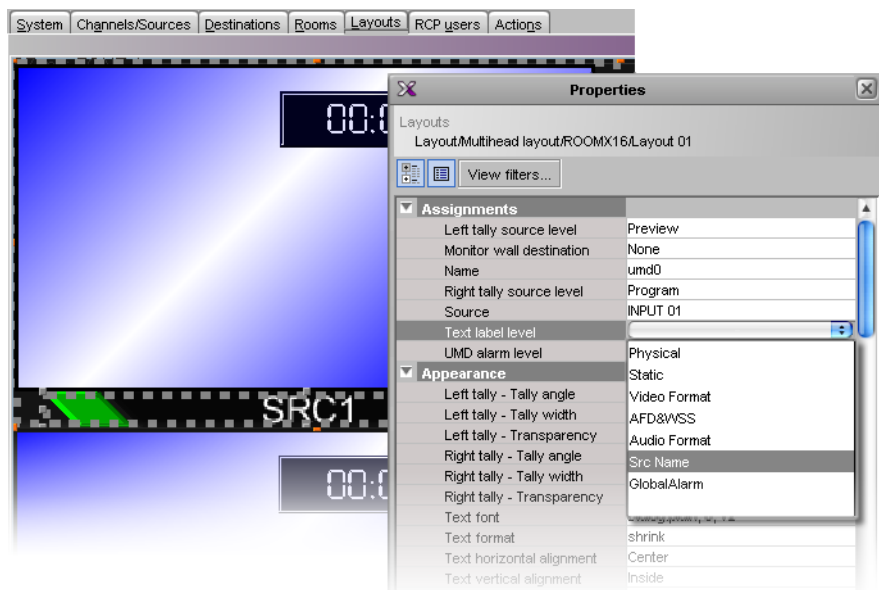

*Text level selection for the text label in a UMD*

- 8 Click outside the composite to lock it, if applicable.
- 9 Repeat [step 4](#) – [step 8](#) until you have configured all UMDs that are to display dynamic text and tally status when this layout is loaded on the monitor wall.
- 10 On the **File** menu, click **Save**.

- 11 If you are working in offline mode, then you must export the database to your multiviewer: on the **Configure** menu, point to **Database**, and then click **Export**.

On the monitor wall, you can now load the layout containing the monitors that were assigned dynamic text and tallies provided by the Zodiac switcher. Input or output names, as well as tally status from the Zodiac switcher will be visible on the monitor wall. Any changes made by the switcher's operator will be immediately reflected on the monitor wall.

## Serial Port Test Agent

During a setup, it is sometime not clear if the wiring between the multiviewer and a peripheral device is correct or if the peripheral device sends the expected data. One can connect a serial-port test agent as a peripheral device in XEdit, export the database to the multiviewer, and then read, on a Web page, the data received on the serial port.

### To use a serial port test agent

- 1 Select the **Serial port test** device in the equipment library and drag it onto the root of the System hierarchical list. Alternatively, right-click the list root, and then click **Insert Serial port test** on the menu.
- 2 Click the **Interconnects** tab in the main window.
- 3 To connect the test device to the multiviewer, click the multiviewer's icon, or the device's, and drag the pointer towards the other.
- 4 Click the test device's icon, and adjust the port settings to match those of the actual peripheral device you wish to test.
- 5 Click the connection line between the device and the multiviewer.
- 6 In the **Properties** pane, select the appropriate element from the **RS-422 communication port** list.

Depending on the multiviewer model, the available RS-422 ports are designated as follows:

KMV-3901/3911	RS-422
Kaleido-X16	Port 1, and Port 2
Kaleido-X (14RU)	Frame A – Output A, B, and C; Frame B – Output A, B, and C
Kaleido-X (7RU)	Output A, B, C, and D
Kaleido-X (4RU)	Output A, and B
Kaleido-MX	Output A, and B Note: The Kaleido-MX (1RU) 16×4 model has only one RS-422 port, which is physically connected to output card A.
Kaleido-Modular-X	Output A, and B Note: KMX-3901-OUT output cards with a single rear connector panel (KMX-3901-OUT-D-3+SRP) do <i>not</i> have RS-422 ports. To support a serial device, your Kaleido-Modular-X system must have at least one output card with a double rear connector panel (KMX-3901-OUT-D-3DRP).

When connected, the serial-port test agent will log all data received from the serial port to a file that you can read using a Web browser.

Once the database is exported to the multiviewer, the serial-port test agent starts. The agent opens the serial port and start writing to a log file the data that is received on the port. To access the log file, point your browser to `http://[IP address]/logs/comm.log`.

---

**Note:** The part `[IP address]` represents the IP address of the output card (or of the multiviewer itself, depending on the model) where the test agent is connected. You can find the IP address on XAdmin's System Configuration page (see [Configuring a Multiviewer's IP Settings](#), on page 456).

---





# 14

## Kaleido Remote Control Protocol

This chapter explains where to obtain information on how the Kaleido-X system can execute commands received via a Gateway, allowing third-party developers and individual users remote access to some Kaleido functions.

### Overview

The Kaleido-X system can execute commands received through a Gateway, allowing third-party developers and individual users remote access to some Kaleido functions. For more information, refer to the *Kaleido Remote Control Protocol (Gateway) User's Guide* (Ref. # M770-0900-XXX), available on the DVD that shipped with your system, and from Grass Valley's support portal.

---

**Note:** The term *Kaleido* is used to describe features common to the Kaleido family. Features exclusive to any one of these products are described using the full product name, e.g. Kaleido-X.

---



# 15

## Using the Serial to TCP/IP Dispatcher

### Overview

The Serial-to-TCP Dispatcher is a piece of software designed to run on a separate PC or embedded into a product (e.g., a Kaleido multiviewer) and act as a bridge between a serial device and the TCP/IP network.

---

Note: For more information, refer to the *Serial-to-TCP Dispatcher Protocol* guide, available on the DVD that shipped with your system.

---



# 16

## Administration and Servicing

This chapter explains how to configure the Kaleido-X network communications, and how to enable hardware and software options. It also describes where to find system status and version information, for troubleshooting or servicing purposes.

### Key Concepts

Term	Description
Kaleido-RCP2	The Kaleido-RCP2 is a multi-function remote control panel designed for use with Kaleido multiviewers. Ethernet connectivity allows multiple RCP users to access multiple Kaleido-X systems, allowing convenient access to real-time operating features.
RCP-200	The RCP-200 advanced remote control panel for Densité cards, Kaleido multiviewers, and NVISION/third party routers provides a highly intuitive graphical interface. It simplifies video/audio signal processing and control in both single and multi-user environments.
Audio Bridge Terminal	The Audio Bridge Terminal (ABT) is an external audio multiplexer/serializer for the Kaleido multiviewers.
XEdit	XEdit is a client application used to create layouts for the monitor wall, and to configure the multiviewer, from your PC or laptop.
XAdmin	XAdmin is a Web client that your system administrator uses to manage the multiviewer system.
System snapshot	The Kaleido-X software generates data to keep track of certain events. This data is stored as log files that can be extracted from the system as a compressed ZIP archive created when requested by the user for specific purposes (e.g. troubleshooting). This ZIP archive is called a system snapshot.
System status	A system status refers to a live summary from within XAdmin. This summary is based on the health status of each module in your multiviewer system (see <a href="#">Viewing a Multiviewer's Status Information</a> , on page 515).
Version	Each software, firmware, and hardware release for the various elements that constitute your Kaleido-X system (e.g. XEdit, XAdmin, etc.) is associated with a version number (see <a href="#">Viewing Version Information</a> , on page 517).

## Default IP Settings

Multiviewers are shipped with the following IP settings.

### Kaleido-IP default IP settings

	Kaleido-IP-6	Kaleido-IP-4	Kaleido-IP-2
Management IP address (LAN1)	10.0.3.70	10.0.3.70	10.0.3.70
Network mask	255.255.0.0	255.255.0.0	255.255.0.0
Default gateway	10.0.0.1	10.0.0.1	10.0.0.1
Data port 1 IP address (LAN2)	172.30.3.70	172.30.3.70	172.30.3.70
Network mask	255.255.0.0	255.255.0.0	255.255.0.0
Data port 2 IP address (LAN3)	172.30.3.71	172.30.3.71	
Network mask	255.255.0.0	255.255.0.0	
Data port 3 IP address (LAN4)	172.30.3.72	172.30.3.72	
Network mask	255.255.0.0	255.255.0.0	
Data port 4 IP address (LAN5)	172.30.3.73		
Network mask	255.255.0.0		
Data port 5 IP address (LAN6)	172.30.3.74		
Network mask	255.255.0.0		

### Kaleido-MX, Kaleido-Modular-X default IP settings

		Dual	Quad
System	IP address	192.168.3.31	192.168.3.30
	Network mask	255.255.255.0	255.255.255.0
	Gateway	0.0.0.0	0.0.0.0
Output A	IP address	192.168.3.31	192.168.3.31
Output B	IP address	—	192.168.3.32

### Densité CPU-ETH2 controller default IP settings

IP address 1	192.168.3.1
Network mask	255.255.255.0
Gateway	0.0.0.0
IP address 2	0.0.0.0
Network mask	0.0.0.0
Gateway	0.0.0.0

**KMV-3901/3911 default IP settings**

System IP address	192.168.3.31
Network mask	255.255.255.0
Gateway	192.168.3.1

**Kaleido-X16 default IP settings**

System IP address	10.0.3.70
Network mask	255.255.0.0
Gateway	10.0.0.1

**Kaleido-X default IP settings**

	4RU	7RU	14RU (expansion)
System IP address	10.0.3.70	10.0.3.70	10.0.3.70
Network mask	255.255.0.0	255.255.0.0	255.255.0.0
Gateway	10.0.0.1	10.0.0.1	10.0.0.1
Output A	10.0.3.69	10.0.3.66	10.0.3.66
Output B	10.0.3.68	10.0.3.67	10.0.3.67
Output C	—	10.0.3.68	10.0.3.68
Output D/EXP	—	10.0.3.69	—
Output A (Frame B)	—	—	10.0.3.61
Output B (Frame B)	—	—	10.0.3.62
Output C (Frame B)	—	—	10.0.3.63

**Note:** If the IP address of the multiviewer has been changed (i.e. it no longer corresponds to the as-shipped configuration), it is still possible to determine the current setting. To determine the IP address of your multiviewer, see [Finding a Multiviewer's System IP Address and Application Version](#), on page 460.

## Hardware and Software Options

You can purchase various software and hardware options to expand your multiviewer's capabilities. The following tables list options that can be enabled and disabled via the XAdmin Status and Options page (see [Enabling Options](#), on page 471).

**Note:** The **Kaleido-IP** currently supports extraction of CC/subtitling and XDS data (1 license/program), and display rotation. It is not yet possible to enable or verify these options in XAdmin's Status and Options page, for this multiviewer model. Contact Technical Support for activation and configuration instructions (see [Contact Us](#), on page 529).

#### Kaleido-MX input options

Option	Part No.	Feature
3G	KMX-IN-8-OPT-3GBPS	3 Gbps signal format license (8 inputs)
	KMX-IN-16-OPT-3GBPS	3 Gbps signal format license (16 inputs)
CC/XDS	KMX-IN-8-OPT-CSX	CC/subtitling and XDS data license (8 inputs)
	KMX-IN-16-OPT-CSX	CC/subtitling and XDS data license (16 inputs)
Dolby E	KMX-IN-8-OPT-DOLBY	Dolby metadata extraction license (8 inputs)
	KMX-IN-16-OPT-DOLBY	Dolby metadata extraction license (16 inputs)

#### Kaleido-MX output options

Option	Part No.	Feature
Second Head Activation	KMX-OUT-OPT-OP2	Second head output enable license for KALEIDO-MX-8X1, KALEIDO-MX-16X1 and KALEIDO-MX-24x1
Display 90-Degree Rotation	KMX-OUT-OPT-ROT-S	Single head rotation license for KALEIDO-MX-8X1, KALEIDO-MX-16X1 and KALEIDO-MX-24x1
	KMX-OUT-OPT-ROT-D	Dual head rotation license. 1 license required for dual head units — 2 licenses required for quad head units.

#### Kaleido-Modular-X input options

Option	Part No.	Feature
3G	KMX-IN-8-OPT-3GBPS	3 Gbps signal format license (8 inputs) for KMX-3901-IN-8-D
	KMX-IN-16-OPT-3GBPS	3 Gbps / 4K UHD <sup>1</sup> signal format license (16 inputs) for KMX-3901-IN-16-D and KMX-3901-IN-16-Q
CC/XDS	KMX-IN-8-OPT-CSX	CC/subtitling and XDS data license (8 inputs) for KMX-3901-IN-8-D
	KMX-IN-16-OPT-CSX	CC/subtitling and XDS data license (16 inputs) for KMX-3901-IN-16-D and KMX-3901-IN-16-Q



### Kaleido-Modular-X input options (continued)

Option	Part No.	Feature
Dolby E	KMX-IN-8-OPT-DOLBY	Dolby metadata extraction license (8 inputs) for KMX-3901-IN-8-D
	KMX-IN-16-OPT-DOLBY	Dolby metadata extraction license (16 inputs) for KMX-3901-IN-16-D and KMX-3901-IN-16-Q

1.4K UHD support requires a minimum of 2 licenses: 1 for the prescaler card, and 1 for every KMX-3901-IN input card connected to the prescaler card.

### Kaleido-Modular-X output options

Option	Part No.	Feature
Second Head Activation	KMX-OUT-OPT-OP2	Second head output enable license for KMX-3901-OUT-S
Display 90-Degree Rotation	KMX-OUT-OPT-ROT-S	Single head rotation license for KMX-3901-OUT-S
	KMX-OUT-OPT-ROT-D	Dual head rotation license for KMX-3901-OUT-D

### KMV-3901/3911 input options

Option	Part No.	Feature
3G	KMV-39N1-8XN-OPT-3GBPS	3Gbps signal decoding option (8 inputs)
	KMV-39N1-4XN-OPT-3GBPS	3Gbps signal decoding option (4 inputs)
Embedded Audio	KMV-39N1-8XN-OPT-AUD	Embedded audio extraction license (8 inputs)
	KMV-39N1-4XN-OPT-AUD	Embedded audio extraction license (4 inputs)
Additional Inputs	KMV-3911-4X1-OPT-4IN	KMV-3911-4x1 additional inputs 5-8 license

### KMV-3901/3911 output options

Option	Part No.	Feature
Second Head Activation	KMV-39N1-NX1-OPT-OP2	Output two enabled license
SDI Monitoring Output	KMV-3911-NX1-OPT-SDI O/P	HD-SDI monitoring output for KMV-3911 (1 SDI output)
	KMV-3911-NX2-OPT-SDI O/P	HD-SDI monitoring output for KMV-3911 (2 SDI outputs)

### KMV-3901/3911 output options (continued)

Option	Part No.	Feature
3D <sup>1</sup>	KMV-39NN-8x2-OPT-3DLA	Stereoscopic display license (line alternate mode) for KMV-3901/3911-8x2
	KMV-39NN-8x1-OPT-3DLA	Stereoscopic display license (line alternate mode) for KMV-3901/3911-8x1
	KMV-39NN-4X2-OPT-3DLA	Stereoscopic display license (line alternate mode) for KMV-3911-4x2
	KMV-39NN-4X1-OPT-3DLA	Stereoscopic display license (line alternate mode) for KMV-3911-4x1

1. After enabling the 3D support option in XAdmin, refresh the current layout or load another one, for the change to be reflected on the monitor wall.

### Kaleido-X (4RU, 7RU, and 14RU) input options

Option	Part No.	Feature	Notes
3G	KXS-3Gbps	3Gbps format license	One 3G option key is needed per input card.
CC/XDS	KXS-CSX	CC/subtitling and XDS data license	One CC/XDS option key is needed per input card. Extraction of CC 608, CC 708, XDS and Subtitling WST metadata is activated as a single option.
Dolby E	KXS-Dolby	Dolby metadata extraction license	One Dolby E option key is needed per input card.
Embedded Audio	KXS-HD-EMB	HD/SD-SDI embedded audio license	One HD/SD-SDI embedded audio option key is needed per input card.
	KXS-SD-EMB	SD-SDI embedded audio license	One SD-SDI embedded audio option key is needed per input card.
Loudness	KXS-Loudness	Loudness level measurement license	One Loudness option key is needed per input card.

### Kaleido-X (4RU, 7RU, and 14RU) output options

Option	Part No.	Feature	Notes
Display 90-Degree Rotation	KXS-Rotator	Display rotation license	One Display 90-Degree Rotation option key is needed per output card.
3D <sup>1</sup>	KXS-3DLA	Stereoscopic display license (line alternate mode) for Kaleido-X	One 3D option key is needed per output card.

1. After enabling the 3D support option in XAdmin, refresh the current layout or load another one, for the change to be reflected on the monitor wall.

### Kaleido-X16 input options

Option	Part No.	Feature
3G	KXS-X16-3Gbps	3Gbps format license (1/frame)
CC/XDS	KXS-X16-CSX	CC/subtitling and XDS data license (1/frame)
Dolby E	KXS-X16-Dolby	Dolby metadata extraction license (1/frame)
Embedded Audio	KXS-X16-HD-EMB	HD/SD-SDI embedded audio license (1/frame)
	KXS-X16-SD-EMB	SD-SDI embedded audio license (1/frame)
Loudness	KXS-X16-Loudness	Loudness level measurement license (1/frame)

### Kaleido-X16 output options

Option	Part No.	Feature
Display 90-Degree Rotation	KXS-X16-Rotator-S	Rotation license for Kaleido-X16-S
	KXS-X16-Rotator-D	Rotation license for Kaleido-X16-D
SDI Monitoring Output	KXS-X16-HDM-S	HD-SDI monitoring output for Kaleido-X16-S
	KXS-X16-HDM-D	HD-SDI monitoring output for Kaleido-X16-D
3D <sup>1</sup>	KXS-X16-3DLA-S	Stereoscopic display license (line alternate mode) for Kaleido-X16-S
	KXS-X16-3DLA-D	Stereoscopic display license (line alternate mode) for Kaleido-X16-D

1. After enabling the 3D support option in XAdmin, refresh the current layout or load another one, for the change to be reflected on the monitor wall.

### Kaleido-X16 router options

Option	Part No.	Feature
SDI Router Output	KXS-X16-RTR16x2	Dual router output option (1/frame)

## Dashboard Messages

The following tables explain messages that may appear in the *Status dashboard* (lower right corner) and in the *Upgrade dashboard* (lower left corner), on the Monitor wall. An "x" in the 7RU, 4RU, X16, KMV, or KMX column indicates that the message applies to a specific multiviewer model, namely:

7RU	Kaleido-X (7RU) and Kaleido-X (14RU)
4RU	Kaleido-X (4RU)
X16	Kaleido-X16
KMV	KMV-3901/3911 and Kaleido-XQUAD
KMX	Kaleido-MX and Kaleido-Modular-X

---

Notes

- There are no dashboard messages for the Kaleido-IP.
  - Messages in the *upgrade dashboard* (see [Upgrade dashboard messages](#), on page 450) apply to the Kaleido-X only.
- 

**Status dashboard messages**

Message	Description	7RU	4RU	X16	KMV	KMX
PSU A absent	PSU A is absent, overheating, has a DC circuitry fault condition, or no current is drawn from it.		x			
PSU B absent	PSU B is absent, overheating, has a DC circuitry fault condition, or no current is drawn from it.		x			
PSU A 48 V	PSU A is absent, overheating, has a DC circuitry fault condition, or no current is drawn from it.	x				
PSU B 48 V	PSU B is absent, overheating, has a DC circuitry fault condition, or no current is drawn from it.	x				
PSU A 48 V Fuse	PSU A fuse is broken.	x	x			
PSU B 48 V Fuse	PSU B fuse is broken.	x	x			
PSU A 12 V	PSU A is absent, overheating, has a DC circuitry fault condition, or no current is drawn from it.			x		
PSU B 12 V	PSU B is absent, overheating, has a DC circuitry fault condition, or no current is drawn from it.			x		
PSU A AC	PSU A power cord is unplugged.		x			
PSU B AC	PSU B power cord is unplugged.		x			
Duplicate IP Address Detected	Another equipment on the network shares the same IP address as an output card.	x	x	x	x	x
Duplicate frame IP address	Another equipment on the network shares the same IP address as the multiviewer system (in a multiple output card setup).					x
Ethernet Link Down	The output card to which this display monitor is connected has lost its network connection.	x	x	x	x	x
Fan 1 (replace whole module if in error)	Fan 1 is running too low or is broken.		x			
Fan 2 (replace whole module if in error)	Fan 2 is running too low or is broken.		x			

**Status dashboard messages (continued)**

Message	Description	7RU	4RU	X16	KMV	KMX
Fan 3 (replace whole module if in error)	Fan 3 is running too low or is broken.		x			
Fan 4 (replace whole module if in error)	Fan 4 is running too low or is broken.		x			
Fan 5 (replace whole module if in error)	Fan 5 is running too low or is broken.		x			
Fan 6 (replace whole module if in error)	Fan 6 is running too low or is broken.		x			
Fan 7 (replace whole module if in error)	Fan 7 is running too low or is broken.		x			
Fan 8 (replace whole module if in error)	Fan 8 is running too low or is broken.		x			
Fan 9 (replace whole module if in error)	Fan 9 is running too low or is broken.		x			
Rear Fan 1 (replace whole module if in error)	Fan 1 is running too low or is broken.	x				
Rear Fan 2 (replace whole module if in error)	Fan 2 is running too low or is broken.	x				
Rear Fan 3 (replace whole module if in error)	Fan 3 is running too low or is broken.	x				
Rear Fan 4 (replace whole module if in error)	Fan 4 is running too low or is broken.	x				
Rear Fan 5 (replace whole module if in error)	Fan 5 is running too low or is broken.	x				
Rear Fan 6 (replace whole module if in error)	Fan 6 is running too low or is broken.	x				
Board temperature high	This warning means that a card is warmer than normal and that you should verify cooling and ventilation (e.g. check for anything obstructing the ventilation openings).	x	x			
Board temperature critical	This alarm means that a card is overheating, which might result in decreased system performance (e.g., green dots, flickering, card not starting). You should halt operations until the overheating problem is resolved.	x	x			
Blower 1 (replace whole module if in error)	Blower 1 is running too low or is broken.			x		
Blower 2 (replace whole module if in error)	Blower 2 is running too low or is broken.			x		
Blower 3 (replace whole module if in error)	Blower 3 is running too low or is broken.			x		

**Status dashboard messages (continued)**

Message	Description	7RU	4RU	X16	KMV	KMX
Blower 4 (replace whole module if in error)	Blower 4 is running too low or is broken.			x		
Card temperature critical	Card is overheating, which might result in decreased system performance (e.g., green dots, flickering, card not starting). You should halt operations until the overheating problem is resolved.	x	x			x
Card temperature high	Temperature warning, which indicates that the card is warmer than normal and that you should verify cooling and ventilation (e.g. check for anything obstructing the ventilation openings).	x	x			x
Critical voltage upper limit reached	One of the voltages is above the critical threshold.					x
Critical voltage lower limit reached	One of the voltages is below the critical threshold.					x
Critical current upper limit reached	Current or power is above the critical threshold.					x
FPGA fan failed	FPGA fan failed					x
Firmware status	Tells whether firmware is running properly on the card.					x
HDMI 0 power failed	HDMI output for first head has a power failure.					x
HDMI 1 power failed	HDMI output for second head has a power failure.					x

**Upgrade dashboard messages**

Message	Description	7RU	4RU
Error during firmware upgrade. Firmware upgrade cannot proceed until legacy KXO (<3.00) are removed from frame B.	This message will appear on an expansion frame with expansion enabled and with cards in Frame B running software or firmware older than version 3.00. To upgrade these cards, transfer them to Frame A.	x	
Error during firmware upgrade. Card presence from frame B could not be verified.	This message will appear as a side effect of the presence of cards in Frame B running a version older than version 3.00. The upgrade will not be permitted on any card in the frame until these cards are removed from Frame B. To upgrade these cards, transfer them to Frame A.	x	

**Upgrade dashboard messages (continued)**

Message	Description	7RU	4RU
Error during firmware upgrade. Duplicate IP has been detected. We cannot continue checking the Firmware version.	This message will appear if duplicate IP addresses are detected between different KXO cards in the frame. As long as this is the case, no upgrade is possible. You must resolve the duplicate IP address issue before resuming the upgrade.	x	x
Error during firmware upgrade. The current firmware version could not be verified.	This message will appear if software cannot retrieve firmware version from the cards. This may indicate an issue with the hardware.	x	x
Error during safemode upgrade. The current safemode version could not be verified.	This message will appear if software cannot retrieve safemode version from the cards. This may indicate an issue with the hardware.	x	x
Error during safemode upgrade. Card presence from frame B could not be verified.	This message will appear as a side effect of the presence of cards in Frame B running a version older than version 3.00. The upgrade will not be permitted on any card in the frame until these cards are removed from Frame B. To upgrade these cards, transfer them to Frame A.	x	
Cannot upgrade card in this slot (if any). Please remove card from [slot number].	This message will appear on an expansion frame if Frame B contains cards running software or firmware older than version 3.00. The upgrade will not be permitted on any card in the frame until these cards are removed from Frame B. To upgrade these cards, transfer them to Frame A.	x	
Cannot upgrade card in this slot. Move card to frame A or swap with card in frame A. Upgrade will proceed after current upgrade.	This message will appear on an expansion frame if Frame B contains cards running software or firmware older than version 3.00. The upgrade will not be permitted on any card in the frame until these cards are removed from Frame B. To upgrade these cards, transfer them to Frame A.	x	
Cannot continue the upgrade until card in this slot is moved to frame A.	This message will appear on an expansion frame with expansion enabled and with cards in Frame B running software or firmware older than version 3.00. To upgrade these cards, transfer them to Frame A.	x	

## Network Considerations & Port Usage

### Network Considerations

#### Kaleido-X, Kaleido-X16, Kaleido-Modular

Kaleido-X, Kaleido-X16, and Kaleido-Modular multiviewers generate a low to moderate amount of client-to-server data traffic, and therefore have a minimal bandwidth impact on a network.

## Kaleido-IP

In the case of a Kaleido-IP multiviewer, it is possible to add and configure up to 6000 logical sources without exceeding the network's bandwidth or the unit's decoding resources.<sup>10</sup> Refer to the Kaleido-IP video inputs section (under "Supported Input/Output Formats"), in the Kaleido-X Release Notes, for details on the number of programs and total streaming bandwidth supported.

The Kaleido-IP multiviewer joins a multicast group only when decoding is required, that is when a source is being monitored on the wall. In addition, streams that are not decoded are joined momentarily in a polling manner—one stream at a time—to update the PMT and PAT information. The Kaleido-IP leaves the multicast group as soon as a change of layout implies that a different set of streams must be decoded.

However, if your situation involves frequent changes of layout (e.g., loading a new layout to the monitor wall every minute), then, when you are creating or editing a layout, make sure to terminate XEdit's connection to the Kaleido-IP once configuration tasks are completed (see [Disconnecting from a Multiviewer](#), on page 77).

## TCP/UDP Port Usage

The various Kaleido-X services require access to specific ports. In networks where a firewall is present between device A and device B, the ports used to communicate **from** device A to device B must be open on the incoming (external) side of the firewall.

---

Note: All necessary ports are open by default on the multiviewer. There is no mechanism provided for changing the default settings.

---

### From client to multiviewer

The following ports must be open on the Client (e.g. workstation running XEdit):

Service	Port	Transport	Notes
HTTPS	443	TCP	Used by XAdmin for secure access
HTTP	80	TCP	Used by XEdit and XAdmin
	5122	TCP	Used by XEdit for "keep alive" (heartbeat)
	5432	TCP	Used by XEdit for export operations
	13000	TCP	Online connection
	13100	TCP	Used for calibration data from XEdit
RCP2	5120	TCP	Used to listen for Kaleido-X discovery packets
	10000	TCP	For RCP2 protocol
	10001	TCP	For RCP2 protocol
	5120	UDP	On multicast 230.8.8.9 for RCP2 protocol
	5121	UDP	For RCP2 protocol

---

10. In the case of a Kaleido-IP X300 model, to support more than 1500 sources, the multiviewer's RAM must be upgraded to 24 GB. Refer to the "Kaleido-IP X300 Memory Modules" section, in the Kaleido-X Release Notes, for installation instructions. The Kaleido-IP X100 is limited to 1500 sources.



**From multiviewer to client**

Service	Port	Transport	Notes
Java RMI	1024–5000 <sup>1</sup> 49152–65535 <sup>2</sup>	TCP	Remote Method Invocation (client/server communication). Dynamic Allocation of ports. Required for communication between client and Application Server.

1. For Windows XP and earlier

2. For Windows 7 and later

**From multiviewer to multiviewer**

The following ports, used for inter-frame communications, are open by default on all Kaleido-X systems:

Service	Port	Transport	Notes
SSH	22	TCP	Secure Shell Login is required to login to a multiviewer for maintenance.
Java Jini	4160	TCP	Responsible for discovery and communications between devices/services on a network.
HTTP	8080	TCP	
	8082	TCP	Internal communication
	8083	TCP	Internal communication
	8084	TCP	Internal communication
	8085	TCP	Internal communication
	8086	TCP	Internal communication
	8087	TCP	Used for debugging purposes
	8090	TCP	Web service
	32769	TCP	filenet-rpc
	5120	UDP	On multicast 230.8.8.9 for RCP2
	7572	UDP	On multicast 230.8.8.8 for "keep-alive" (heartbeat)
7571	UDP	For "keep-alive" (heartbeat)	
Densité	5100	TCP	Internal communication within a Kaleido-MX, or Kaleido-Modular-X multiviewer system; communication with modules housed in a Densité frame.

### From iControl to multiviewer

Service	Port	Transport	Notes
Java RMI	32768–65535	TCP	Remote Method Invocation (client/server communication). Dynamic Allocation of ports. Required for communication between client and Application Server. This range can be restricted to match specific security requirements. A minimum of 4000 ports should be allocated.

### From multiviewer to/from remote control panel

The following ports, used for communications to/from RCP-200 and Kaleido-RCP2 control panels, are open by default on all Kaleido-X systems:

Service	Port	Transport	Notes
RCP2	5120	TCP	Used to listen for Kaleido-X discovery packets
	10000	TCP	For RCP2 protocol
	10001	TCP	For RCP2 protocol
	5120	UDP	On multicast 230.8.8.9 for RCP2 protocol
	5121	UDP	For RCP2 protocol
HTTP	80	TCP	Used by the RCP-200 to obtain information from the multiviewer's system database
	13000	TCP	Used by the RCP-200 to control the multiviewer via the gateway

### From multiviewer to peripheral devices

Service	Port	Transport	Notes
SMTP	25	TCP	Simple Mail Transfer Protocol, for e-mail alerts.
Alpermann+Velte timer system	8851	TCP	Used to obtain information from Plura's Alpermann+Velte timer systems.
GPI-1501	5100	TCP	Used to obtain information from GPI-1501 General Purpose Interface I/O modules. <sup>1</sup>
TSL (network)	8910 <sup>2</sup>	TCP	Used to obtain information from TSL devices that use the TSL UMD version 5.0 protocol.

1. See also: [From multiviewer to multiviewer](#), on page 453.

2. Configurable.

### From peripheral devices to multiviewer

The following ports must be open on peripheral devices (e.g. router controllers):

Port	Transport	Notes
2000	TCP	Used to control the Kaleido-X internal router via the Snell (Pro-Bel) SW-P-02 protocol
4381	TCP	Used to control the Kaleido-X internal router via the Nevion (Network) protocol
5194	TCP	Used to control the Kaleido-X internal router via the NVISION Ethernet protocol - Compact router protocol.
14000	TCP	Used to control the Kaleido-X internal router via the Snell (Pro-Bel) SW-P-08 protocol

Router drivers also use default ports:

Driver	Port	Transport	Notes
ETL	4000	TCP	
GVG 7000 Native	12345	TCP	
NVISION Ethernet protocol - Enterprise router	9193	TCP	
VikinX Modular	4381	TCP	
Quintech	9100	TCP	
Sony HKSPC	12345	TCP	GVGNP Emulator
Utah RCP-3	5001	TCP	SC-4 Ethernet
Snell (Pro-Bel) SW-P-02	2000	TCP	
Snell (Pro-Bel) SW-P-08	14000	TCP	

---

**Note:** This is configurable in XEdit—you can choose any UDP or TCP/IP port to use for communications between the multiviewer and an external router.

---

### From multiviewer to/from SNMP devices

Service	Port	Transport	Notes
SNMP	161	UDP	Simple Network Management Protocol, used for communications between multiviewer and peripheral devices (e.g. sending get, get-next, and set commands to an SNMP agent, and receiving the response).
	162	UDP	Simple Network Management Protocol, used for receiving traps (alerts) from peripheral devices.

### From multiviewer to/from NTP server

The following ports, used for communications to/from Network Time Protocol servers, are open by default on all Kaleido-X systems:

Service	Port	Transport	Notes
NTP	123	TCP	Used for Network Time Protocol synchronization. Port needs to be open in both directions.

## Detailed Directions

### Assigning an IP Address to Each Device in your System

Multiviewers and most peripheral devices that are part of a Kaleido-X system communicate through a TCP/IP network. Configuring your system's network parameters includes the following:

- Assigning an IP address, and specifying the appropriate network mask, gateway address, and a system name for each multiviewer. Refer to [Default IP Settings](#), on page 442, and to [Configuring a Multiviewer's IP Settings](#), below.
- Configuring the RCP-200, or Kaleido-RCP2, if available. Refer to [Configuring the RCP-200](#), on page 462, or to [Configuring the Kaleido-RCP2](#), on page 466.
- Configuring the Audio Bridge Terminal (ABT), if available. Refer to [Configuring an Audio Bridge Terminal](#), on page 469.

### Configuring a Multiviewer's IP Settings

#### To change your system's IP address and other parameters

- 1 Open XAdmin. See [Opening XAdmin](#) on page 487.
- 2 Click **System configuration**, in the navigation area on the left of the page.

The System Configuration page appears, showing the current system name, IP settings, as well as the date and time settings.

The screenshot shows the Miranda XADMIN web interface. The top navigation menu includes: System configuration, Status and options, Access control, and Technical support. The main content area is divided into sections: General, Ethernet, and Date and Time. In the General section, the System name is set to '1234-1' and the 50 Hz system frame rate checkbox is unchecked. The Ethernet section shows the Frame IP address as 10.0.3.70, Network mask as 255.255.0.0, and Default gateway as 10.0.0.1. The Detected link mode is 100Mbps full-duplex and the Configured link mode is set to Auto-negotiate. The Date and Time section shows the current date and time as Thursday October 17, 2013 09:07:52 AM UTC-4, with the date and time format set to English (United States) and the time zone set to America/New\_York. NTP synchronization is currently disabled. Buttons for 'Apply settings...', 'Log out', and 'Save' are visible.

- 3 Type a different name for your system if you wish.

If there are more than one multiviewer in the same network environment, it is important to assign each a unique system name, so that you can tell them apart (for example, when using a remote control panel such as the Kaleido-RCP2 or RCP-200).

---

#### Notes

- In the case of a Kaleido-IP multiviewer, the system name must comply with RFC 1123, because it is also used as the device's host name. Up to 8 characters are allowed, limited to A-Z, a-z, 0-9, and the hyphen. The system name cannot start or end with an hyphen.
  - For the other multiviewer models, only lower-ASCII characters are allowed in the system name. Braces and tilde are not allowed.
- 

In the absence of a reference signal, a Kaleido-X or Kaleido-X16 will process its video inputs at a default frame rate of 59.94 Hz.

- 4 If your system requires a 50 Hz frame rate, to match the input signal data sampling rate, in the absence of a reference signal, then select the corresponding check box.

---

**Note:** The **50 Hz system frame rate** option applies to the Kaleido-X and Kaleido-X16 multiviewers only.

---

- 5 Adjust the date and time settings, as required.  
Clocks in your layouts will then display date and time in the applicable format.
- 6 Enter the appropriate IP information: frame or card IP addresses, network mask, and default gateway.
- 7 In the case of a Kaleido-IP, to omit network configuration for an unused data port, clear the corresponding **Enabled** check box.

By default, all network adapters are set to auto-negotiate. The connection speed and duplex mode will be set automatically based on the corresponding port settings on the associated switch. The current speed and link mode are displayed next to **Detected link mode**, for every network adapter.

- Should your network configuration require specific speed and duplex mode settings, select the appropriate value from the **Configured link mode** list.

**Ethernet**

Frame IP address:	10	0	3	70
Network mask:	255	255	0	0
Default gateway:	10	0	0	1
Detected link mode:	100Mbps full-duplex			
Configured link mode:	Auto-negotiate			

Auto-negotiate  
100Mbps half-duplex  
100Mbps full-duplex  
Auto-negotiate

---

**Note:** As required by the IEEE-802.3 standard, section 28D.5, 1000 Mbps full-duplex communication is only supported via auto-negotiation.

---

- Click **Save**.

The new settings are saved locally.

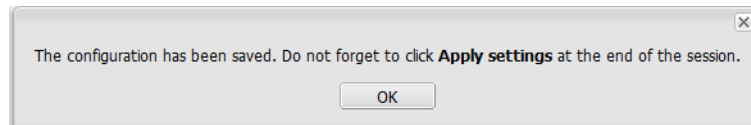

- Click **OK**.

The **Apply settings** button becomes available.

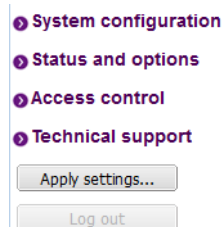

- Click **Apply settings**.

The Kaleido-X system must be restarted for changes to the network configuration to take effect. A message appears prompting you to reboot the system immediately.

- Click **OK**.

---

**Note:** Settings cannot be applied to a multiviewer system while an upgrade is in progress. If the multiviewer does not reboot after 10 seconds or so, try clicking **Apply settings** again after a minute or two, until the multiviewer reboots.

---

Remember to change your client PC's IP address to one that matches the new subnet (see [Changing the Client PC's IP Address](#), on page 460). You will also need to edit the XAdmin URL in your Web browser's address bar, in order to log on to the multiviewer again.

## Configuring a Multiviewer's IP Settings Without a Client PC

### Notes

This section *does not* apply to the KMV-3901/3911, Kaleido-XQUAD, Kaleido-MX, and Kaleido-Modular-X. For these multiviewers, you can configure the network settings by using XAdmin, the Densité controller's local control panel, or a control panel in iControl, if available. See [Configuring a Multiviewer's IP Settings](#) on page 456, or refer to the Quick Start Guide for your multiviewer, for details.

In the case of a Kaleido-IP, changing the multiviewer's network settings from the monitor wall is not yet supported.

With a Kaleido-X, or Kaleido-X16, you can set the IP address, system name, and other parameters via a control panel, directly on the monitor wall.

### To change the multiviewer's system IP address, and adjust your system's configuration

- 1 Connect a mouse to any USB port on the multiviewer.
- 2 Right-click anywhere on the monitor wall. On the menu, point to **Monitor wall**, and then click **System Configuration**.

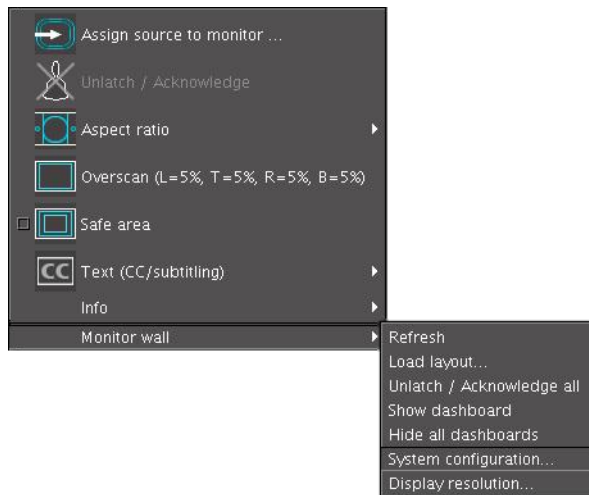

- 3 Change the configuration settings as necessary, and then click **OK**.

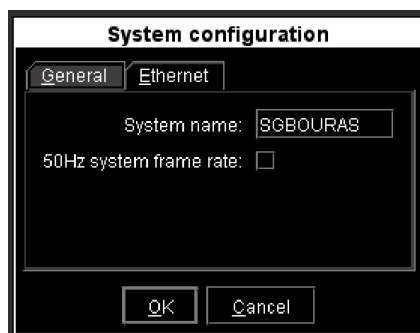

- 4 Click **Yes** when prompted to restart the system.

## Finding a Multiviewer's System IP Address and Application Version

To find the system IP address, system name and application version

- Right-click anywhere on the monitor wall. On the menu, point to **Monitor wall**, and then click **Show dashboard** to display the dashboard associated with the current output head.

A small window appears, revealing the system IP address and the system version.

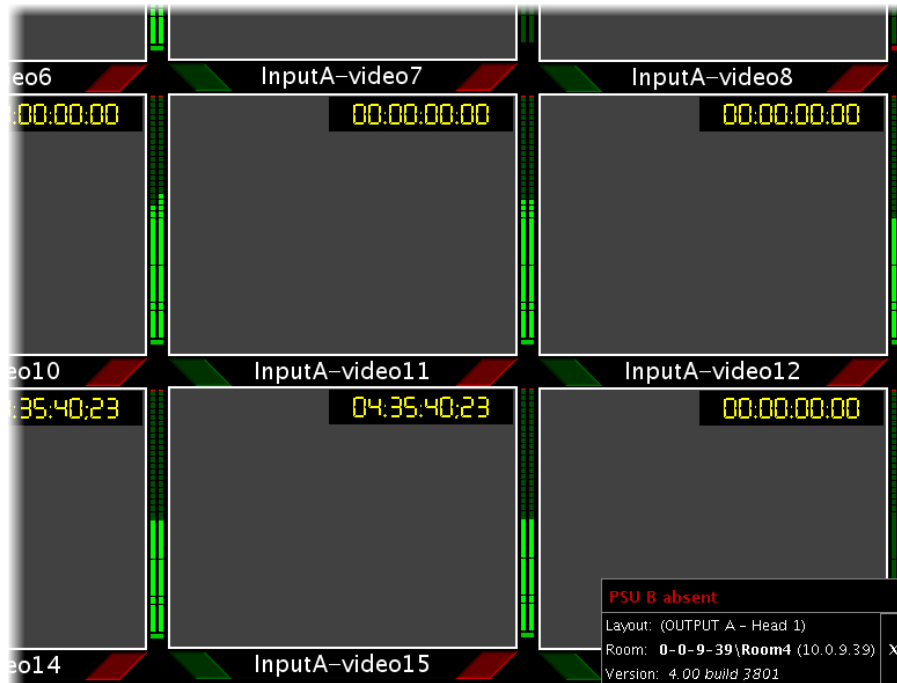

Partial view of a monitor wall display showing dashboard at the bottom right

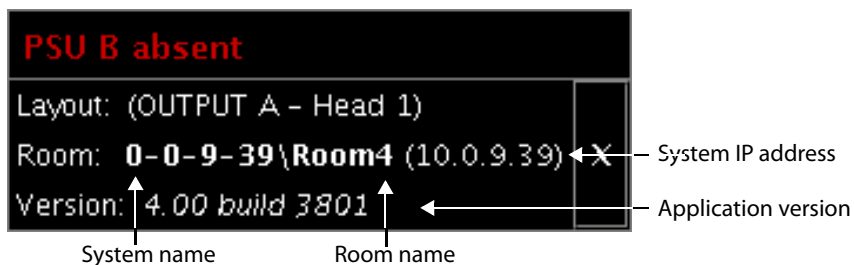

Enlarged view of dashboard.

## Changing the Client PC's IP Address

Both the client computer you use to communicate with the multiviewer (e.g., via XAdmin, and XEdit), and the multiviewer itself must have IP addresses within the same subnet. Kaleido multiviewers are shipped with the default IP settings listed under [Default IP Settings](#), on page 442. The following procedure applies to a typical Windows 7 or Windows 8 system. For Windows XP, see [Changing an IP address on Windows XP](#), on page 462.



## Changing an IP address on Windows 7 or Windows 8

### To change the IP address of a client PC that has Windows 7 or Windows 8

- 1 Press the Windows key on your keyboard, type "control panel" and then press Enter.
- 2 In the search box, type "adapter"; and then, under **Network and Sharing Center**, click **View network connections**.
- 3 In **Network Connections**, right-click the network adapter you wish to configure (e.g., *Local Area Connection*, or *Ethernet*), and then click **Properties**. If the system prompts you for an administrator password or confirmation, type the password or provide confirmation.

The Properties window for the selected network adapter opens.

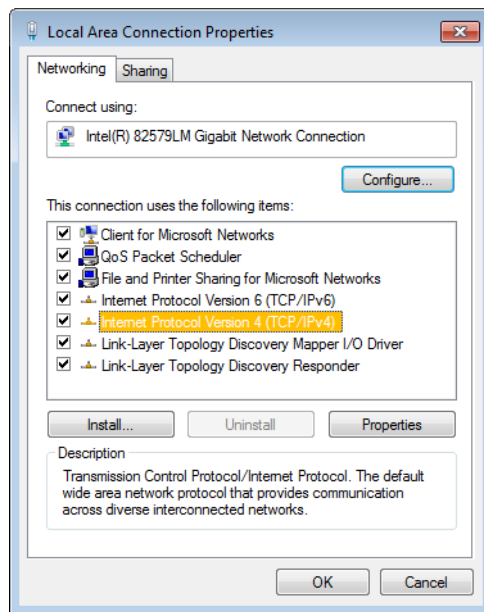

- 4 On the **Networking** tab, under **This connection uses the following items**, click **Internet Protocol Version 4 (TCP/IPv4)**, and then click **Properties**.  
The **Internet Protocol Version 4 (TCP/IPv4) Properties** window opens.
- 5 On the **General** tab, click **Use the following IP address**.

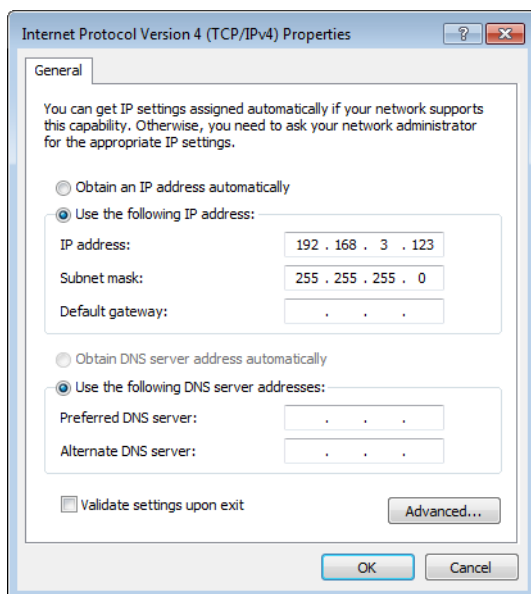

- 6 Type an IP address in the same range as the multiviewer's current IP address.  
For example, if the multiviewer's IP address is 192.168.3.31, then the IP address of your client PC could be 192.168.3.123. If you are unsure, contact your network administrator.
- 7 Type a subnet mask in the same range as that of the multiviewer.
- 8 Click **OK**.
- 9 In **Local Area Connection Properties**, click **Close**.

### Changing an IP address on Windows XP

#### To change the IP address of a client PC that has Windows XP

- 1 On the **Start** menu, point to **Control Panel**, right-click **Network Connections**, and then click **Open** on the menu.
- 2 In **Network Connections**, right-click **Local Area Connection**, and then click **Properties** on the shortcut menu.
- 3 In **Local Area connection Properties**, select **Internet Protocol (TCP/IP)** from the list on the **General** tab, and then click **Properties**.  
The **Internet Protocol (TCP/IP) Properties** window opens.
- 4 On the **General** tab, click **Use the following IP address**.
- 5 Type an IP address in the same range as the multiviewer's current IP address.  
For example, if the multiviewer's IP address is 10.0.3.70, then the IP address of your client PC could be 10.0.3.123. If you are unsure, contact your network administrator.
- 6 Type a subnet mask in the same range as that of the multiviewer.
- 7 Click **OK**.
- 8 In **Local Area Connection Properties**, click **Close**.

### Configuring the RCP-200

The RCP-200 is shipped with an IP address of 10.0.3.200. On installation, you should consult your system administrator and replace this address with an appropriate address for your

local network configuration (see [Configuring the RCP-200's IP settings](#), below). Once your RCP-200 has an active connection to the network, you must then register the multiviewers you wish to operate from the RCP-200 (see [Specifying multiviewers for the RCP-200](#), on page 463), and their respective *KX Router* logical routers (see [Specifying lookup servers for the RCP-200](#), on page 463). Once this is completed, you will be able to control the monitor wall from the RCP-200 (see [Logging on to the RCP-200](#), on page 464).

### Configuring the RCP-200's IP settings

#### To assign an IP address to the RCP-200

- 1 Press the CONFIG button, located between the two screens on the front of the RCP-200.
- 2 Touch the COMM category at the top of the right-hand screen.
- 3 Touch the ETHERNET tab on the right-hand screen.
- 4 In the SELECT area, rotate the leftmost control knob to select IP ADDRESS.
- 5 Use the four control knobs in the CHANGE area to set the new address.  
The current address is displayed in the CURRENT box for reference, and the new address you are setting appears in the MODIFIED box, as well as at the controls.
- 6 Press the SAVE control knob to store the new address.
- 7 Repeat from [step 4](#) to configure the NETWORK MASK and GATEWAY settings.
- 8 Press the RESTART control knob to apply the changes.  
The panel will go dark for about 15 seconds before the startup screens appear.

### Specifying multiviewers for the RCP-200

#### To specify a multiviewer for the RCP-200

- 1 Press the CONFIG button, located between the two screens on the front of the RCP-200.
- 2 Touch the COMM category on the right-hand screen.
- 3 Touch the KALEIDO DISCOVERY tab on the right-hand screen.
- 4 Use the four control knobs in the ADD TO LIST area to dial in the IP address of the multiviewer you wish to operate.  
The address appears in the TO ADD box.
- 5 Press the ADD control knob.  
The multiviewer's IP address appears in the LOOKUP LIST area.
- 6 Press the CONFIG button, located between the two screens on the front of the RCP-200 to end the configuration process and return to normal operation.

### Specifying lookup servers for the RCP-200

The RCP-200 needs to connect to a lookup server in order to control devices, including a multiviewer's *KX router* logical router.

#### To specify a lookup server for the RCP-200

- 1 Press the CONFIG button, located between the two screens on the front of the RCP-200.
- 2 Touch the COMM category on the right-hand screen.
- 3 Touch the DISCOVERY tab on the right-hand screen.

- 4 Use the four control knobs in the ADD TO LIST area to dial in the IP address of the multiviewer you wish to operate.  
The address appears in the TO ADD box.
- 5 Press the ADD control knob.  
The multiviewer's IP address appears in the LOOKUP LIST area.
- 6 Press the CONFIG button, located between the two screens on the front of the RCP-200 to end the configuration process and return to normal operation.

### Logging on to the RCP-200

---

**Note:** In a default system configuration, a multiviewer's video outputs are assigned to specific rooms:

- On a Kaleido-X (7RU), the two DVI/VGA outputs from each of the dual-head Output cards A, B, C and D are assigned to ROOM1, ROOM2, ROOM3 and ROOM4 respectively.
  - On a Kaleido-X (4RU), the two DVI/VGA outputs from each of the dual-head Output cards A and B are assigned to ROOM1 and ROOM2 respectively.
  - On a Kaleido-X (14RU) expansion system, the two DVI/VGA outputs from each of the dual-head Output cards A, B and C of each of Frame A and Frame B are assigned to ROOM1, ROOM2, ROOM3, ROOM4, ROOM5 and ROOM6 respectively.
  - On a Kaleido-X16-D, the HDMI outputs from each of the Output modules are assigned to ROOMX16.
  - On a Kaleido-X16-S, the HDMI output is assigned to ROOMX16.
  - On a KMV-3901/3911, Kaleido-XQUAD, or Kaleido-XQUAD-DUAL, the HDMI outputs are assigned to ROOM1.
  - On a Kaleido-IP, the multiviewer outputs are assigned to ROOM.
  - On a Kaleido-MX, or Kaleido-Modular-X, the HDMI outputs are assigned to ROOM1.
- 

### To log on to a Kaleido-X room from the RCP-200

- 1 On an RCP-200 with an active connection to the network, press the LIST button.  
All devices, and Kaleido-X rooms, detected by the RCP-200 appear on the left screen. Kaleido-X rooms are listed in the form [multiviewer name]\[room name].  
If a room belongs to a cluster system, its name appears once for each of the member multiviewers (e.g. if two multiviewers, KX1 and KX2, are configured as a cluster, and ROOM1 includes displays fed by both multiviewers, then both KX1\ROOM1 and KX2\ROOM1 will be listed. To determine the one you should select, review the following:
  - Has the RCP user configuration you wish to use been replicated on every member of the cluster (see [Replicating RCP Users Across a Cluster System](#), on page 93)?
  - Do you need to control an external router whose configuration is available only from one or some specific members of the cluster?

- Does your system configuration include actions that were configured only on one or some specific members of the cluster?
- Do you need to control a timer from the monitor wall in a cascade room?

If any of the above elements is available only from one or some specific members, then make sure you select the room name prefixed with the appropriate multiviewer name. In the case of a cascade room, unless you remember which multiviewer you were connected to when you added the timer you need to control, you will have to proceed by trial and error.

- 2 Touch the room you wish to access (press the DOWN or UP soft keys to scroll the list as needed).

The list of users assigned to this room appears on the right-hand screen.

- 3 Touch the user name under which you wish to log on, enter your password, and then touch LOG IN.

---

Note: By default, the user "Admin" has no password.

---

The following message appears on the right-hand screen: PLEASE SELECT A ROUTER FROM THE LEFT-HAND SCREEN, prefixed with the name of the multiviewer that appeared before the room name you selected in [step 2](#).

- 4 In the list on the left-hand screen, touch the *KX Router* logical router associated with the same multiviewer (you can see the multiviewer name, its IP address, and the size of that particular KX Router).
- 5 Touch the Video level, in the area to the right of the router list, if it is not selected already, and then push SELECT.

The room's monitor wall control panel appears on the right-hand screen, with the ASSIGN CHANNEL category selected. If a mouse is connected to the RCP-200, then after touching WALL MOUSE you should be able to see and move the mouse pointer on the monitor wall.

- If the room you selected belongs to a *cascade* system, touch a monitor showing a source you can identify as coming from a different multiviewer than the one indicated with the room name you selected in [step 2](#).
- If the room you selected belongs to a *cluster* system, rotate the HEAD knob (or touch the DISPLAY SELECT category) to display a head view from a different member of the cluster, and then touch a monitor.

The ROUTER SELECT category becomes selected instead of ASSIGN CHANNEL, and the right-hand screen shows the message prompting you to select a router from the left-hand screen, prefixed with the name of the multiviewer, which means that you still need to complete the correlation between some monitor wall destinations and the representation of the KX Router logical router for this multiviewer. See [Correlating Monitor Wall Destinations and KX Router Logical Routers for the RCP-200](#) below. Repeat this for one head, with one layout, for every multiviewer that is part of the cluster of cascade. If you need to connect to a different instance of the same room then

you will have to establish the correlation again, to be able to operate the monitor wall from the different context.

---

#### Notes

- The RCP-200 will remember your user credentials until you log out explicitly (by touching LOG OUT at the upper-right corner of the control panel).
  - The pointer may flicker when two RCP users access displays fed by the same multiviewer output.
  - Two users accessing the same display will be limited to sharing a single pointer.
- 

For more information on the RCP-200, please refer to the *RCP-200 Guide to Installation and Operation*, available on the DVD that shipped with your system, and from Grass Valley's support portal.

### **Correlating Monitor Wall Destinations and KX Router Logical Routers for the RCP-200**

To operate the monitor wall from the RCP-200's category/index router view, your system must have been configured to be controlled as a router. In a layout, the RCP-200 can only control monitors that have been assigned a monitor wall destination. The first time you log on to a room from the RCP-200, you will be prompted to select a router from the left-hand screen. By selecting the appropriate KX Router logical router, you will establish the correlation between your multiviewer's monitor wall destinations and the RCP-200's representation of the multiviewer's *KX Router* logical router. In the case of a cluster or cascade system, you will also be prompted to select a router, the first time to try to assign a source to a monitor located in a part of the layout that belongs to a different member of the cluster or cascade. You only need to do this once, for every multiviewer that is part of a cluster (or cascade).

#### **To correlate a monitor wall destination in a layout and the corresponding KX Router logical router**

- 1 In the list on the left-hand screen, touch the *KX Router* logical router associated with the multiviewer whose name was indicated in the message prompting to select a router (you can see the multiviewer name, its IP address, and the size of that particular KX Router).
- 2 Touch the Video level, in the area to the right of the router list, if it is not selected already, and then push SELECT.

The RCP-200 will remember the association with the KX Router logical router's destinations for the current multiviewer's monitor wall destinations.

### **Configuring the Kaleido-RCP2**

The Kaleido-RCP2 is a multi-function remote control panel designed for use with Kaleido multiviewers. Ethernet connectivity allows multiple RCP users to access multiple Kaleido-X systems, allowing convenient access to the real-time operating features. When logged on to a Kaleido multiviewer via its Ethernet connection, the RCP user can control various operating features.

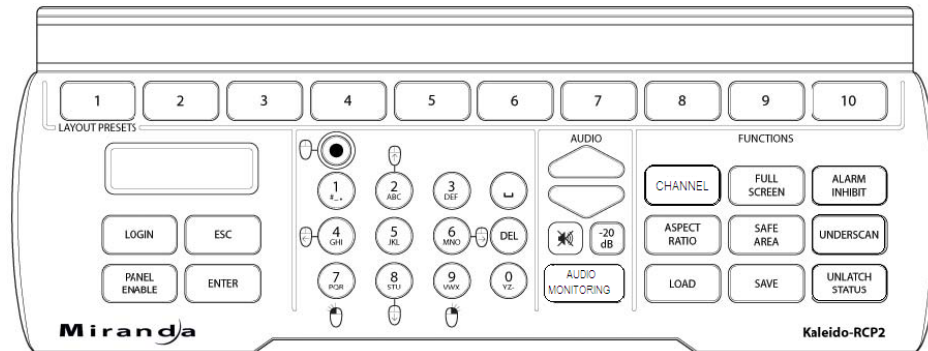

Before you can use the Kaleido-RCP2 to operate your Kaleido-X, you must set up the Ethernet connection between the two devices. By default, the Kaleido-RCP2 is shipped with DHCP enabled, so it will automatically be assigned an IP address by a DHCP server. If no DHCP server is present on the network, the Kaleido-RCP2 will default to the static IP address 10.0.3.191.

#### Notes

- The Kaleido-RCP2 is powered through the RJ-45 Ethernet connector. There is no power ON/OFF button, so the device is ON whenever a powered Ethernet cable is connected.
- If you purchased more than one Kaleido-RCP2 units, keep in mind that they all ship with the same default static IP address. Make sure to assign them different static IP addresses before connecting them to the network if DHCP is not used.
- The time-out period before the Kaleido-RCP2 defaults to its static address is 1 minute. To speed up the initialization, disable the DHCP option.

### Assigning a static IP address to the Kaleido-RCP2

#### To assign a static IP address to the Kaleido-RCP2

- 1 Press and hold the ENTER button until the ESC button lights up, to display the configuration menu.
- 2 Press the **8** key (to move down the list) until ETHERNET OPTIONS appears on the LCD display.
- 3 Press the ENTER key to display the ETHERNET OPTIONS menu.
- 4 Select the IP ADDRESS menu using the **2** key (to move up in the list) or the **8** key (to move down the list), and then press ENTER.
- 5 Using the numeric keypad, type the chosen IP address, and then press ENTER.
- 6 Select the NETWORK MASK menu using the **2** key (to move up in the list) or the **8** key (to move down the list), and then press ENTER.
- 7 Using the numeric keypad, type the chosen network mask, and then press ENTER.

You have assigned a static IP address to the Kaleido-RCP2.

## Selecting a room for the Kaleido-RCP2

### To select a room for the Kaleido-RCP2

- 1 Press and hold the ENTER button until the ESC button lights up, to display the configuration menu.
- 2 In the ROOM SELECTION display, press ENTER again to get the room list from the Kaleido-X systems that are currently available on the network.
- 3 In the room list, select the room you wish to access by pressing the **2** key (to move up in the list) or the **8** key (to move down the list).

---

**Note:** By default, a multiviewer's video outputs are assigned to specific rooms:

- On a Kaleido-X (7RU), the two DVI/VGA outputs from each of the dual-head Output cards A, B, C and D are assigned to ROOM1, ROOM2, ROOM3 and ROOM4 respectively.
- On a Kaleido-X (4RU), the two DVI/VGA outputs from each of the dual-head Output cards A and B are assigned to ROOM1 and ROOM2 respectively.
- On a Kaleido-X (14RU) expansion system, the two DVI/VGA outputs from each of the dual-head Output cards A, B and C of each of Frame A and Frame B are assigned to ROOM1, ROOM2, ROOM3, ROOM4, ROOM5 and ROOM6 respectively.
- On a Kaleido-X16-D, the HDMI outputs from each of the Output modules are assigned to ROOMX16.
- On a Kaleido-X16-S, the HDMI output is assigned to ROOMX16.
- On a KMV-3901/3911, Kaleido-XQUAD, or Kaleido-XQUAD-DUAL, the HDMI outputs are assigned to ROOM1.
- On a Kaleido-IP, the multiviewer outputs are assigned to ROOM.
- On a Kaleido-MX, or Kaleido-Modular-X, the HDMI outputs are assigned to ROOM1.

- 4 When the appropriate room name is highlighted, press ENTER to accept the new selection.
- 5 When prompted, log on to the selected room. See [Logging on to the Kaleido-RCP2](#) on page 469.

## Connecting the Kaleido-RCP2 to Other Kaleido-X Systems

The unicast IP feature enables a Kaleido-RCP2 to find up to three Kaleido-X systems on different subnets and connect to them (via network gateways), while maintaining connections to Kaleido-X systems in its own subnet.

---

### Notes

- To navigate the Kaleido-RCP2 menu, press the **2** key to move up, or the **8** key to move down.
  - There is no need to configure unicast IP addresses for Kaleido-X systems on the same subnet as the Kaleido-RCP2.
-



### To configure a unicast IP address on the Kaleido-RCP2

- 1 Press and hold the ENTER button until the ESC button lights up, to display the configuration menu.
- 2 Select ETHERNET OPTIONS on the LCD display, and then press ENTER.
- 3 Select **Unicast host IP**, and then press ENTER.
- 4 Select **Enable IP 1**, and then press ENTER.  
The Enable IP x parameter instructs the Kaleido-RCP2 to query the selected IP address for a list of rooms.
- 5 Select **Host IP ADDR**, and then press ENTER.
- 6 Using the numeric keypad, type the IP address of a Kaleido-X on a remote subnet, and then press ENTER.
- 7 Repeat [step 4](#) to [step 6](#) to add unicast IP addresses for up to three remote Kaleido-X systems.

### Logging on to the Kaleido-RCP2

As a network device, the Kaleido-RCP2 provides access to any room configuration on any Kaleido-X system on the network. As a security measure, access is controlled by a login procedure.

#### To log on to a Kaleido-X system from the Kaleido-RCP2

- 1 Press the LOGIN key.  
The following message will appear on the LCD display:  
LOGIN Position  
Admin
- 2 Press ENTER to select "Admin".  
A message prompting you to enter a password will appear on the LCD display.
- 3 Press ENTER again (by default, there is no password).  
The message "Access granted" will appear on the LCD display if the login is successful. If a mouse is connected to the Kaleido-RCP2, then you should be able to see and move the mouse pointer on the monitor wall.

---

**Note:** If at any time the message "Target system is offline" or "No login list available" appears on the LCD display, press the ESC, ENTER and DEL keys simultaneously and go back to [step 1](#).

---

For more information, refer to the *Kaleido-RCP2 Guide to Installation and Operation*, available on the DVD that shipped with your system, and from Grass Valley's support portal.

### Configuring an Audio Bridge Terminal

---

**Note:** The KMV-3901/3911, and Kaleido-IP multiviewers are not compatible with the Audio Bridge Terminal.

---

The Audio Bridge Terminal (ABT) is an external audio multiplexer/serializer for Kaleido multiviewers. The ABT provides connector space for audio signal inputs, and multiplexes all

the audio signals into combined serial feeds on coaxial cables that connect to the multiviewer's input modules.

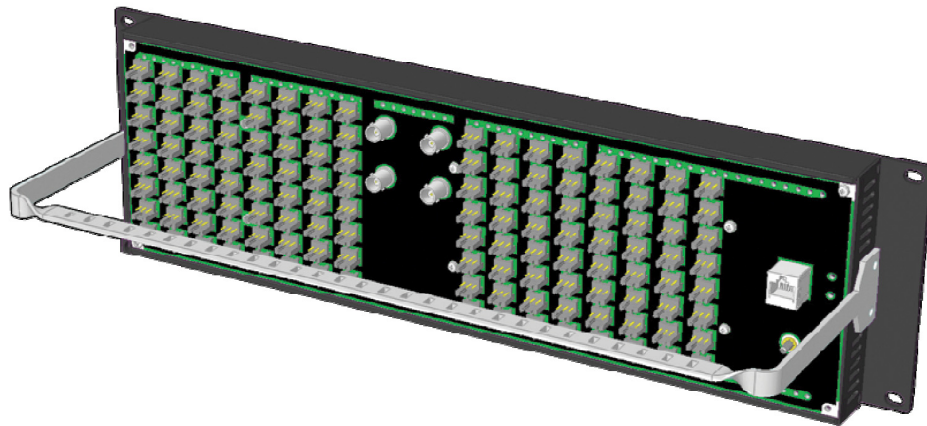

---

**Note:** The ABT is powered through the RJ-45 Ethernet connector. There is no power ON/OFF button, so the device is ON whenever a powered Ethernet cable is connected.

---

**To configure the IP address and other network settings of the ABT**

- 1 Connect a PC to a switch.
- 2 Referring to [Changing the Client PC's IP Address](#), on page 460, configure the PC with the following network settings:

DHCP	Off
Static IP address	10.0.0.1
Subnet mask	255.255.0.0
Default gateway	10.0.0.1

- 3 Apply power to the Audio Bridge Terminal and make sure it is connected to the same switch as the PC. If the switch is Power over Ethernet (PoE) enabled, simply connect it to the unit using an Ethernet cable. If not, PoE mid-span ("inserter") equipment must be placed between the switch and the Audio Bridge Terminal.
- 4 Press the RESET button (located on the right-hand side of the ABT rear panel beside the ETHERNET/POWER RJ-45 connector) for at least 1 second. The Audio Bridge Terminal will reboot with the following static network configuration:

DHCP	OFF
Static IP address	10.0.3.190
Subnet mask	255.255.0.0
Default gateway	10.0.0.1

- 5 Using a Web browser on the PC, connect to the ABT using the following address: 10.0.3.190.

The home page of the ABT's built in Web server is displayed.

- Click **Network Configuration** (in the navigation pane).  
The Network Configuration page is displayed.

**Miranda - Audio Bridge Terminal**

Status  
Parameters  
Network Configuration  
Information

**Network Configuration**

MAC Address: 00:50:1E:01:FF:DD

Label: QA-ABT-128 Valid characters: a-z A-Z 0-9 - \_ \*

DHCP:  Disabled  Enabled

Static IP Address: 10 . 5 . 5 . 251

Static Network Mask: 255 . 255 . 255 . 0

Static Default Gateway: 10 . 5 . 5 . 1

Apply & Reboot Cancel Changes Factory Defaults

- Change the ABT's network settings, as necessary, and then click **Apply & Reboot**.

**Note:** If you purchased more than one Audio Bridge Terminal unit, keep in mind that they all ship with the same default static IP address. Make sure to assign each of them a different static IP address before connecting them to the network, if DHCP is not used.

For more information, please refer to the *Audio Bridge Terminal Guide to Installation and Operation*, available on the DVD that shipped with your system, and from Grass Valley's support portal.

## Enabling Options

### To enable options on a multiviewer

- Open XAdmin. See [Opening XAdmin](#) on page 487.  
The XAdmin Status and Options page appears.

Miranda XADMIN

System configuration  
Status and options  
Access control  
Technical support

Apply settings...  
Log out

Kaleido-X16-D (s/n 079201-18372020)  
Firmware 0x64 / Safemode 0x2

SYSTEM  
ROUTER OUTPUTS  
VIDEO INPUTS  
Inputs: ●●●●●●●●●●  
MULTI-VIEWER OUTPUTS

- Click the arrow button at the end of the heading row that corresponds to the module for which you wish to enable an option.

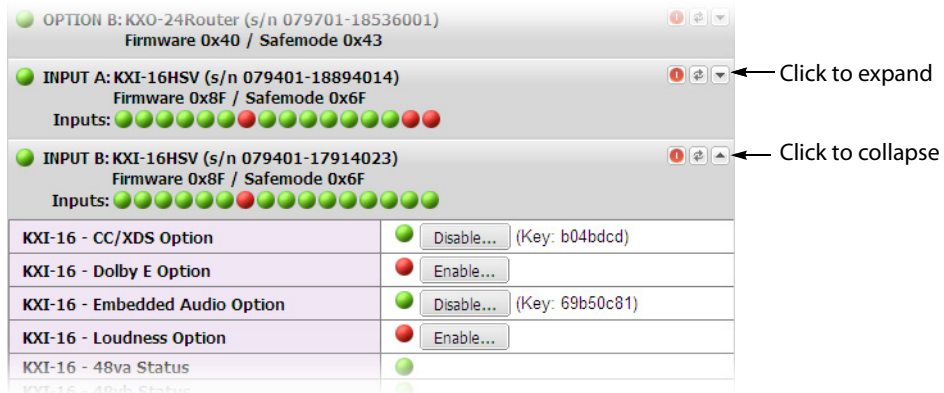

- 3 Locate the entry for the option you wish to enable.  
For example, to activate the Extraction of CC, Subtitling and XDS metadata option (CC/XDS Option) for a Kaleido-X input card, you would need to locate the appropriate card in XAdmin's Status and Options page, expand it, and then locate the **KXI-16-CC/XDS option** line.
- 4 Click the **Enable** button.  
A window appears prompting you for the option key.

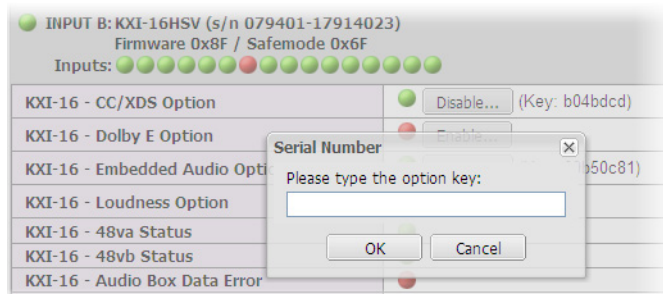

- 5 Enter the key for the specific option in the box, and then click **OK**.  
Once the option is enabled, the key is displayed, and a **Disable** button replaces the **Enable** button.

### Notes

- The Kaleido-IP currently supports extraction of CC/subtitling and XDS data (1 license/program), and display rotation. It is not yet possible to enable or verify these options in XAdmin's Status and Options page, for this multiviewer model. Contact Technical Support for activation and configuration instructions (see [Contact Us](#), on page 529).
- One CC/XDS Option key is needed per input card, and the extraction of CC 608, CC 708, XDS and Subtitling WST metadata are all activated as a single option.
- After enabling the 3D Support option in XAdmin, refresh the current layout or load another one, for the change to be reflected on the monitor wall.
- For a complete list of the options that can be enabled and disabled via the XAdmin Status and Options page, see [Hardware and Software Options](#), on page 443.

## Installing Kaleido-X Client Applications

In addition to the XAdmin Web client, which does not require installation, the Kaleido-X software includes the following client applications:

- XEdit is a client application used to create layouts for the monitor wall, and to configure your multiviewer system, from your PC or laptop. When the computer with XEdit is connected to the multiviewer through a TCP/IP network, you can use XEdit to modify layouts and settings directly on the multiviewer, or you can work locally on the computer and then export your changes to the multiviewer.
  - If you have only one multiviewer (or if you have more than one but you intend to always have the same version of the Kaleido-X software on all of them), download the XEdit installer file from the multiviewer's home page. Whenever you install a new version of the Kaleido-X software on the multiviewer, the next time you open XEdit, your copy of the application will be automatically updated from the multiviewer. See [Installing XEdit from your Multiviewer's Home Page](#) on page 473.
  - If you need to keep *different versions of XEdit on the same PC or laptop* (for example, you may have multiple multiviewers, some of which may not always have the same version of the Kaleido-X software as the others), use a *versioned* XEdit installer file, available from the Kaleido-X DVD and from Grass Valley's support portal. When you use the standalone installer, XEdit is *not* automatically updated. See [Installing a Specific Version of XEdit](#) on page 476.
- The Router Control Software Single Bus and Matrix View applications (also part of the iRouter Router Control Software packaged with iControl Application Servers) can be used to control your multiviewer's logical sources and monitor wall destinations, via the *KX Router* logical router, or to control other logical routers configured within your multiviewer system. See [Installing Router Control](#) on page 481.
- Signal Path Viewer opens as a standalone panel, updated in real time, showing assignment information between router sources and multiviewer inputs. Signal Path Viewer is available for all multiviewer models, except Kaleido-IP (for which it is not relevant). See [Installing Signal Path Viewer](#) on page 485.

### Installing XEdit from your Multiviewer's Home Page

#### To install XEdit from your multiviewer's home page

- 1 From a workstation on the same subnet as the multiviewer, open a Web browser window and type the multiviewer's IP address in the address bar.  
The multiviewer's home page appears.



- 2 Click the **XEdit** button.

The browser prompts you to save an executable file to your hard drive (kaleido-windows32-online.exe<sup>11</sup>). This file is an online installer, which will download XEdit and other companion elements from your multiviewer, and install them. Some browsers may allow you to run the file directly. Depending on your browser's security features, warnings may appear, which you may safely dismiss.

- 3 Unless your browser let you run the file (and you chose to do so), navigate to the location were you saved the installer file and open it.

More security warnings or prompts may appear, which you may safely dismiss or accept.

A window appears, showing the download and installation progress.



At the end of the installation process:

- If you have Windows 7, or Windows XP, shortcuts (  ) are added to your desktop and to the Start menu (under **All Programs**).

---

11. Installers for Linux or Mac OS X are not yet available.

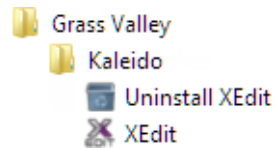

- If you have Windows 8.1, or Windows 8, XEdit will appear on your desktop, in the Apps view with all the other applications on your PC (Windows 8.1), or in your Start screen (Windows 8).

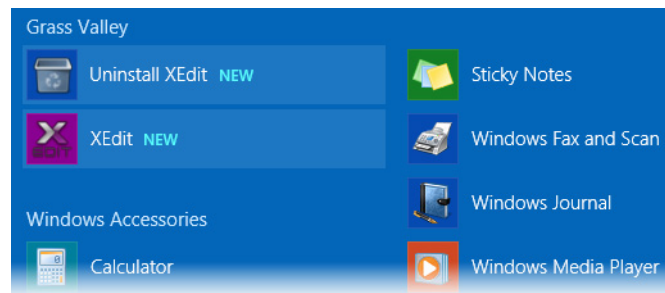

Once the installation has completed, the XEdit startup screen appears.



Depending on your Windows Firewall settings, a security alert may appear.

- Click **Allow access** to unblock the application.

If XEdit cannot find all of the fonts it needs already on your PC or laptop, it downloads them from the multiviewer automatically, in which case a message will appear to confirm the font update, and instruct you to restart the application.

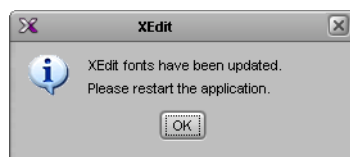



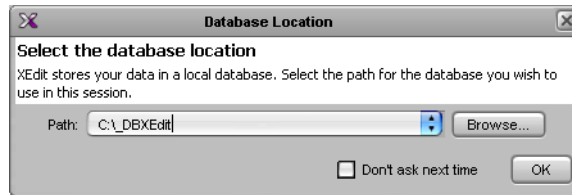

- Click **OK** to continue, and then open XEdit again, by using the shortcut on your desktop, in your Apps view (Windows 8.1) or Start screen (Windows 8), or from the Start menu (Windows 7, Windows XP).
- 4 When prompted to specify a database, choose one from the **Path** list, or click **Browse** to navigate to the database you wish to use as your local workspace, and then click **OK**.

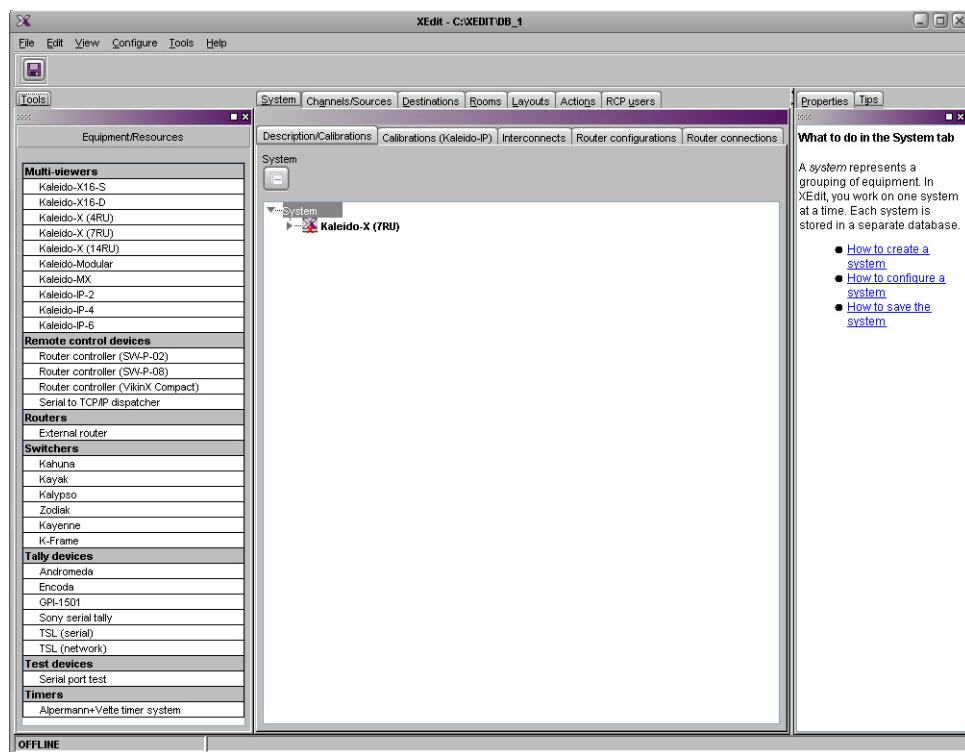

Once the database has completed loading, XEdit's main application window appears.



**Note:** Once it has been installed from the multiviewer, XEdit remains on your PC or laptop, and can be launched from the  shortcut that was added to your desktop, Apps view, or Start screen (see [page 474](#)), or from the Start menu. Whenever you install a new version of the Kaleido-X software on the multiviewer, the next time you open XEdit, your installed copy of the application will be automatically updated from the multiviewer.

## Installing a Specific Version of XEdit

*Versioned* XEdit installers are available from the Kaleido-X DVD and from Grass Valley's support portal. The installer file name (of the form `Kaleido X.XX build XXXX-windows32-offline.exe`) indicates the Kaleido-X software version and build number, and the target operating system.<sup>12</sup>





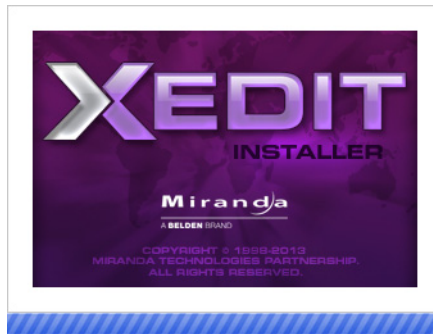

### To install a specific version of XEdit

- 1 Save a copy of the versioned installer file you wish to use to your hard drive (e.g., Kaleido 7.60 build 5630-windows32-offline.exe).
- 2 Open the installer file.  
Security warnings or prompts may appear, which you may safely dismiss or accept.  
A progress indicator window appears while XEdit is installed.



At the end of the installation process,

- if you have Windows 7, or Windows XP, shortcuts (  ) are added to your desktop and to the Start menu (under **All Programs**);  
 Grass Valley  
 Kaleido 7.60  
 Uninstall XEdit  
 XEdit
- if you have Windows 8.1, or Windows 8, XEdit will appear on your desktop, in the Apps view with all the other applications on your PC (Windows 8.1), or in your Start screen (Windows 8).

Once the installation has completed, the XEdit startup screen, and **Database Location** window appear.



### Notes

- Depending on your Windows Firewall settings, a security alert may appear.
  - Click **Allow** access to unblock the application.
- If the installer cannot find all of the fonts it needs already on your PC or laptop, it adds them automatically to the install folder, in which case a message will appear to confirm the font update, and instruct you to restart the application.

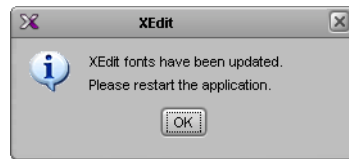

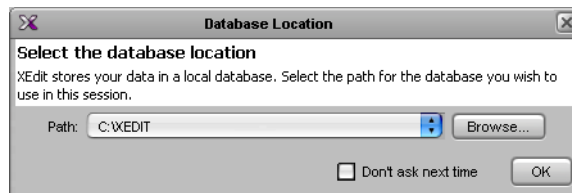

- Click **OK** to continue, and then open XEdit again, by using the shortcut on your desktop, in your Apps view (Windows 8.1) or Start screen (Windows 8), or from the Start menu (Windows 7, Windows XP).

- 3 In **Database Location**, choose a database from the **Path** list, or click **Browse** to navigate to the database you wish to use as your local workspace, and then click **OK**.

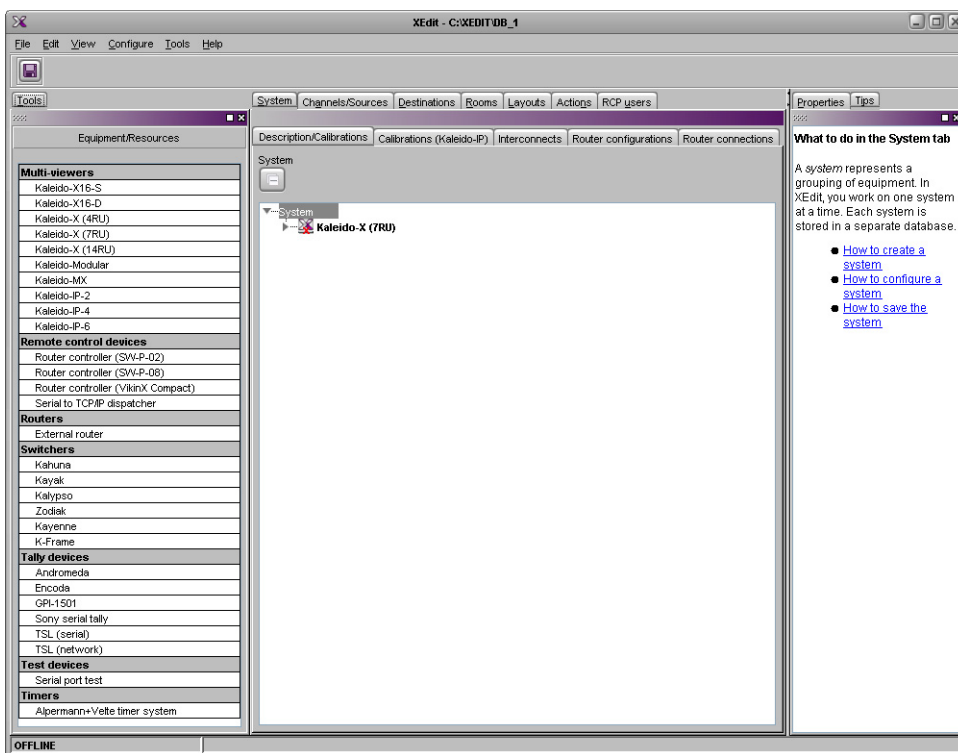

- 4 Once the database has completed loading, XEdit's main application window appears.



Note: Once it has been installed from the multiviewer, XEdit remains on your PC or laptop, and can be launched from the  shortcut that was added to your desktop, Apps view, or Start screen, or from the Start menu.

If you have installed multiple versions of XEdit, the shortcut on your desktop opens the last version you installed. To open a specific version of XEdit, use the shortcut on the Start menu (under **All Programs**) or in your Apps view or Start screen.

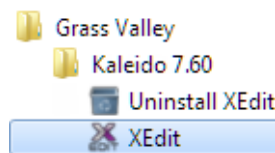

## Uninstalling XEdit

With recent versions of XEdit, an uninstall program is available from the Windows Start menu.

- If you installed XEdit from your multiviewer's home page, see [Uninstalling XEdit \(Dynamic Version 7.20 or Later\)](#), below.
- If you chose to install specific versions of XEdit by using the appropriate *versioned installers* (from the Kaleido-X DVD or from Grass Valley's support portal) — for example, you have more than one multiviewer system, and they have different versions of the Kaleido-X software —, see [Uninstalling XEdit \(Static Version 7.20 or Later\)](#), on page 480.

If you have been using XEdit versions *earlier* than 7.20 you may want to uninstall them, by clearing the Java cache, on your PC or laptop. See [Uninstalling XEdit \(Version 7.11 or Earlier\)](#) on page 481.

### Uninstalling XEdit (Dynamic Version 7.20 or Later)

#### To uninstall XEdit (dynamic version 7.20 or later)

- 1 Close all XEdit windows you may have open.
- 2 Locate the **Uninstall XEdit** shortcut.
  - If you have Windows 7, or Windows XP: Open the Start menu, click All Programs, scroll to the Grass Valley (or Miranda Technologies<sup>13</sup>) folder, and then expand the Kaleido folder.

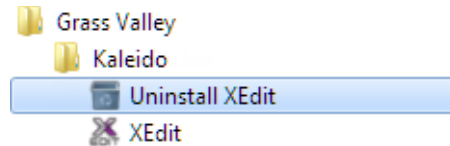

- If you have Windows 8.1, or Windows 8: Switch to the App view or your Start screen.
- 3 Click **Uninstall XEdit**.

An uninstall screen appears.

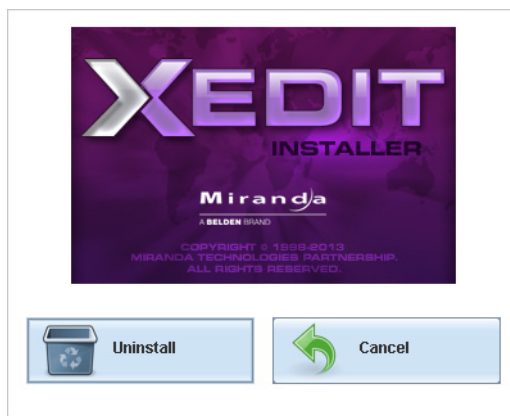

- 4 Click **Uninstall**.

This removes XEdit, including all shortcuts, launchers, and other elements that were installed with it, from your system.

### Uninstalling XEdit (Static Version 7.20 or Later)

#### To uninstall XEdit (static version 7.20 or later)

- 1 Close all XEdit windows you may have open.
- 2 Locate the **Uninstall XEdit** shortcut for the version you wish to uninstall.
  - If you have Windows 7, or Windows XP: Open the Start menu, click All Programs, scroll to the Grass Valley (or Miranda Technologies<sup>14</sup>) folder, and then expand the Kaleido folder matching the version you wish to uninstall.

---

13.Launcher icons for versions 7.20–7.52 would have been installed in the Miranda Technologies folder.

14.Launcher icons for versions 7.20–7.52 would have been installed in the Miranda Technologies folder.

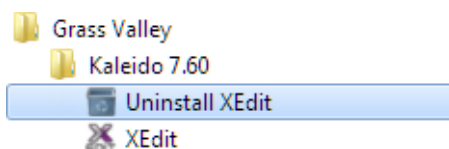

- if you have Windows 8.1, or Windows 8: Switch to the App view or your Start screen.

3 Click **Uninstall XEdit**.

An uninstall screen appears.

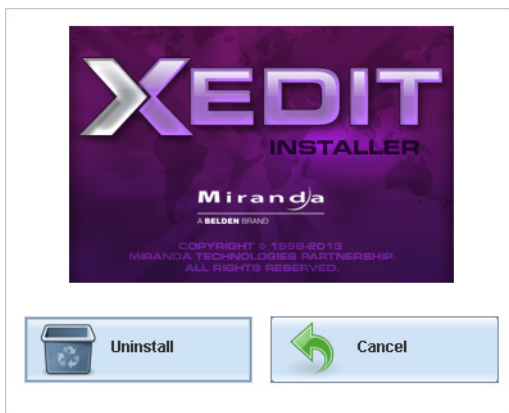

4 Click **Uninstall**.

This removes the selected version XEdit, including all shortcuts, launchers, and other elements that were installed with it, from your system.

### Uninstalling XEdit (Version 7.11 or Earlier)

#### To uninstall XEdit (version 7.11 or earlier)

- 1 Close all Java applications you may have open.
- 2 On the Start menu, click **Control Panels**, and then click **Java (32-bit)**.  
**Java Control Panel** opens.
- 3 In the **General** tab, click **Settings**.
- 4 In **Temporary Files Settings**, click **Delete Files**.
- 5 In **Delete Files and Applications** select all the check boxes, and then click **OK**.
- 6 Close **Temporary Files Settings**, and then **Java Control Panel**, by clicking their **OK** button.

### Installing Router Control

#### To install Router Control from your multiviewer's home page

- 1 From a workstation on the same subnet as the multiviewer, open a Web browser window and type the multiviewer's IP address in the address bar.  
The multiviewer's home page appears.
- 2 Click the **Router Control** button.  
The browser prompts you to save an executable file to your hard drive (Kaleido\_\_RouterControl-windows32-online.exe<sup>15</sup>). This file is an online installer,

which will download Router Control and other companion elements from your multiviewer, and install them. Some browsers may allow you to run the file directly. Depending on your browser's security features, warnings may appear, which you may safely dismiss.

- 3 Unless your browser let you run the file (and you chose to do so), navigate to the location were you saved the installer file and open it.

More security warnings or prompts may appear, which you may safely dismiss or accept.

A window appears, showing the download and installation progress.



At the end of the installation process:

- If you have Windows 7, or Windows XP, shortcuts (  ) are added to your desktop and to the Start menu (under **All Programs**).

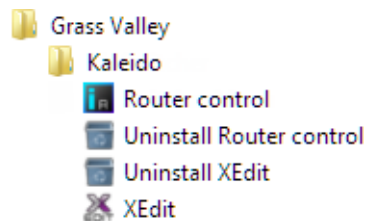

- If you have Windows 8.1, or Windows 8, Router Control will appear on your desktop, in the Apps view with all the other applications on your PC (Windows 8.1), or in your Start screen (Windows 8).

Once the installation has completed, the Router Control main application window appears. The application automatically connects to your multiviewer. The main window lists all logical routers configured within your multiviewer system, in addition to the *KX Router* logical router.

---

15. Installers for Linux or Mac OS X are not available.

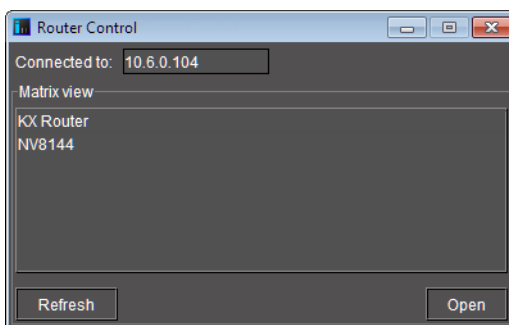

- 4 In **Router Control**, click the router you wish to control, and then click **Open**. Depending on your Windows Firewall settings, a security alert may appear.
- Click **Allow access** to unblock the application.
- The Matrix View application window opens.

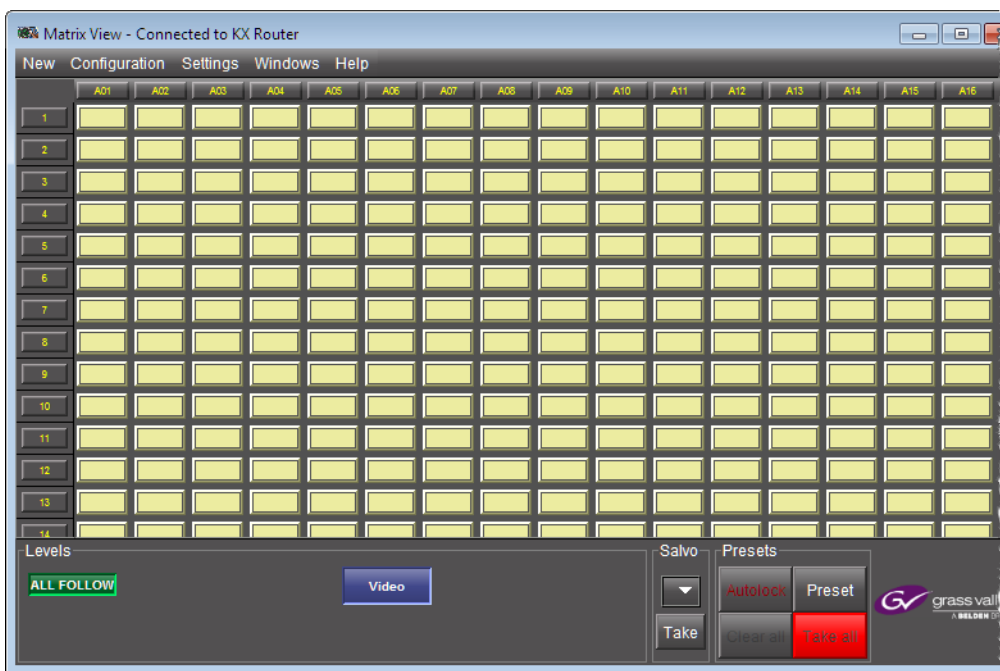

On the **Help** menu, click **Help** to access the online documentation, or refer to the iRouter User Guide, available on the DVD that shipped with your system.

### Notes

- Once it has been installed from the multiviewer, Router Control remains on your PC or laptop, and can be launched from the  shortcut that was added to your desktop, Apps view, or Start screen (see [page 482](#)), or from the Start menu. Whenever you install a new version of the Kaleido-X software on the multiviewer, the next time you open Router Control, your installed copy of the application will be automatically updated from the multiviewer.
- Router Control can also connect to other Kaleido multiviewers or iControl Application Servers, and control their routers.

Notes (continued)

- Routers configured within a Kaleido multiviewer system are compatible with the Router Control modules packaged with iControl Application Servers version 6.10 and later.
- When Router Control is connected to an Application Server, a router manager configuration application is available from the main application window. When Router Control is connected to a Kaleido multiviewer, this router manager configuration application is not available (router configuration is performed with XEdit, in this case).

## Uninstalling Router Control

### To uninstall Router Control (Windows 7, Windows XP)

- 1 Close all Router Control windows you may have open.
- 2 Locate the **Uninstall Router Control** shortcut.
  - If you have Windows 7, or Windows XP: Open the Start menu, click All Programs, scroll to the Grass Valley folder, and then expand the Kaleido folder.

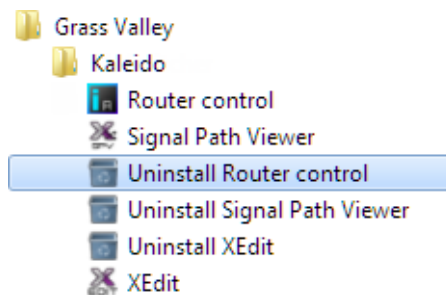

- If you have Windows 8.1, or Windows 8: Switch to the App view or your Start screen.

- 3 Click **Uninstall Router Control**.

An uninstall screen appears.

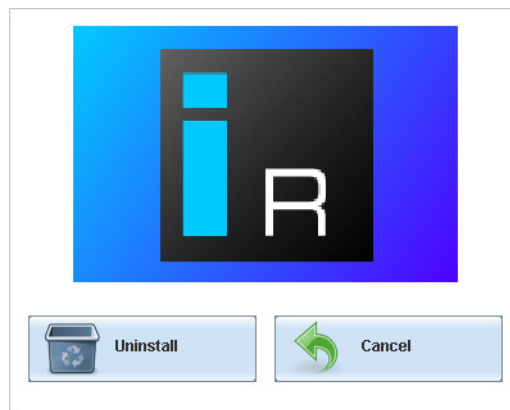

- 4 Click **Uninstall**.

This removes Router Control, including all shortcuts, and other elements that were installed with it, from your system.



## Installing Signal Path Viewer

### To install Signal Path Viewer from your multiviewer's home page

- 1 From a workstation on the same subnet as the multiviewer, open a Web browser window and type the multiviewer's IP address in the address bar.

The multiviewer's home page appears.

- 2 Click **Launch the Signal Path Viewer**.

The browser prompts you to save an executable file to your hard drive (Kaleido\_\_SignalPathViewer-windows32-online.exe<sup>16</sup>). This file is an online installer, which will download Signal Path Viewer from your multiviewer, and install it. Some browsers may allow you to run the file directly. Depending on your browser's security features, warnings may appear, which you may safely dismiss.

- 3 Unless your browser let you run the file (and you chose to do so), navigate to the location where you saved the installer file and open it.

More security warnings or prompts may appear, which you may safely dismiss or accept.

A window appears, showing the download and installation progress.



At the end of the installation process:

- If you have Windows 7, or Windows XP, shortcuts (  ) are added to your desktop and to the Start menu (under **All Programs**).

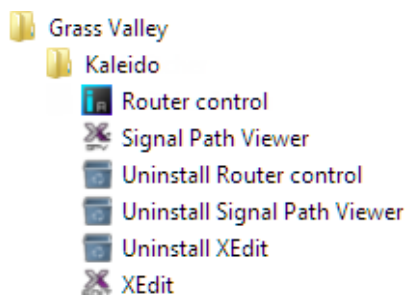

- If you have Windows 8.1, or Windows 8, Signal Path Viewer will appear on your desktop, in the Apps view with all the other applications on your PC (Windows 8.1), or in your Start screen (Windows 8).

---

<sup>16</sup>Installers for Linux or Mac OS X are not available.

Once the installation has completed, the Signal Path Viewer panel appears. Depending on your Windows Firewall settings, a security alert may also appear.

- Click **Allow access** to unblock the application.

The application automatically connects to your multiviewer.

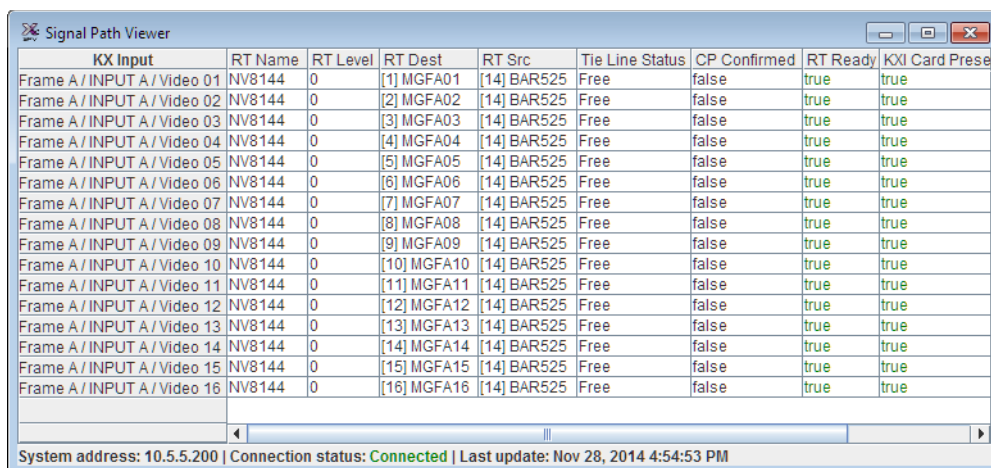

KX Input	RT Name	RT Level	RT Dest	RT Src	Tie Line Status	CP Confirmed	RT Ready	KXI Card Pres
Frame A / INPUT A / Video 01	NV8144	0	[1] MGFA01	[14] BAR525	Free	false	true	true
Frame A / INPUT A / Video 02	NV8144	0	[2] MGFA02	[14] BAR525	Free	false	true	true
Frame A / INPUT A / Video 03	NV8144	0	[3] MGFA03	[14] BAR525	Free	false	true	true
Frame A / INPUT A / Video 04	NV8144	0	[4] MGFA04	[14] BAR525	Free	false	true	true
Frame A / INPUT A / Video 05	NV8144	0	[5] MGFA05	[14] BAR525	Free	false	true	true
Frame A / INPUT A / Video 06	NV8144	0	[6] MGFA06	[14] BAR525	Free	false	true	true
Frame A / INPUT A / Video 07	NV8144	0	[7] MGFA07	[14] BAR525	Free	false	true	true
Frame A / INPUT A / Video 08	NV8144	0	[8] MGFA08	[14] BAR525	Free	false	true	true
Frame A / INPUT A / Video 09	NV8144	0	[9] MGFA09	[14] BAR525	Free	false	true	true
Frame A / INPUT A / Video 10	NV8144	0	[10] MGFA10	[14] BAR525	Free	false	true	true
Frame A / INPUT A / Video 11	NV8144	0	[11] MGFA11	[14] BAR525	Free	false	true	true
Frame A / INPUT A / Video 12	NV8144	0	[12] MGFA12	[14] BAR525	Free	false	true	true
Frame A / INPUT A / Video 13	NV8144	0	[13] MGFA13	[14] BAR525	Free	false	true	true
Frame A / INPUT A / Video 14	NV8144	0	[14] MGFA14	[14] BAR525	Free	false	true	true
Frame A / INPUT A / Video 15	NV8144	0	[15] MGFA15	[14] BAR525	Free	false	true	true
Frame A / INPUT A / Video 16	NV8144	0	[16] MGFA16	[14] BAR525	Free	false	true	true

System address: 10.5.5.200 | Connection status: **Connected** | Last update: Nov 28, 2014 4:54:53 PM

For each multiviewer input, the panel displays, in real time, the current router source assignment, the corresponding router destination, as well as router status information. In the case of a Kaleido-X multiviewer model, it also indicates if an input card has been removed.

### Notes

- Signal Path Viewer is available for all multiviewer models, except Kaleido-IP (for which it is not relevant).
- Once it has been installed from the multiviewer, Signal Path Viewer remains on your PC or laptop, and can be launched from the  shortcut that was added to your desktop, Apps view, or Start screen (see [page 485](#)), or from the Start menu. Whenever you install a new version of the Kaleido-X software on the multiviewer, the next time you open Signal Path Viewer, your installed copy of the application will be automatically updated from the multiviewer.
- Should you need Signal Path Viewer to connect to a different multiviewer, then you must install it again, from the other multiviewer's home page.
- In the case of a Kaleido-X multiviewer, if you remove or reseat output cards, Signal Path Viewer may stop displaying real-time updates, in which case close the application and then open it again.

## Uninstalling Signal Path Viewer

### To uninstall Signal Path Viewer (Windows 7, Windows XP)

- 1 Close all Signal Path Viewer windows you may have open.
- 2 Locate the **Uninstall Signal Path Viewer** shortcut.
  - If you have Windows 7, or Windows XP: Open the Start menu, click All Programs, scroll to the Grass Valley folder, and then expand the Kaleido folder.

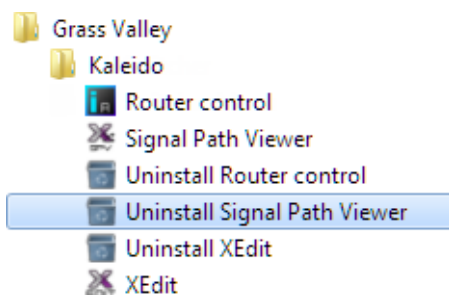

- If you have Windows 8.1, or Windows 8: Switch to the App view or your Start screen.

3 Click **Uninstall Signal Path Viewer**.

An uninstall screen appears.



4 Click **Uninstall**.

This removes Signal Path Viewer, including all shortcuts, and other elements that were installed with it, from your system.

## Opening XAdmin

There are two ways to access the XAdmin Web client: from a **Web browser** (see [Opening XAdmin from a Browser](#), below), and from **XEdit** (see [Opening XAdmin from XEdit](#), on page 488). The first time you access XAdmin for a multiviewer (and every time the multiviewer's IP address has changed), you may see a security warning or a certificate error message. The procedures below include instructions on how to address these messages (see [Registering your Multiviewer's Security Credentials with your Browser](#), on page 489). Internet Explorer users may also need to enable compatibility view (see [Enabling the Compatibility View in Internet Explorer 10](#), on page 498).

### Opening XAdmin from a Browser

#### To open XAdmin from a browser

- 1 Configure your client PC with an IP address in the same range as the IP address of the multiviewer, if needed (see [Changing the Client PC's IP Address](#), on page 460).
- 2 Open a Web browser window and enter the multiviewer's IP address in the address bar. The Kaleido-X home page appears.



- 3 Click the XAdmin button.
- 4 If you see a security warning, or a certificate error message, then refer to [Registering your Multiviewer's Security Credentials with your Browser](#), on page 489.
- 5 If the "Log in to XAdmin" page appears, type the password, and then click **Log in**.

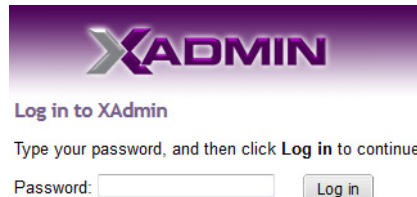

- 6 **Internet Explorer users:** If a blank page appears, then refer to [Enabling the Compatibility View in Internet Explorer 10](#), on page 498.  
The XAdmin Status and Options page appears. You can access all XAdmin features, by clicking the links, in the navigation area on the left of the page.

## Opening XAdmin from XEdit

### To open XAdmin from XEdit

- 1 On the **Configure** menu, click **Use XAdmin**.

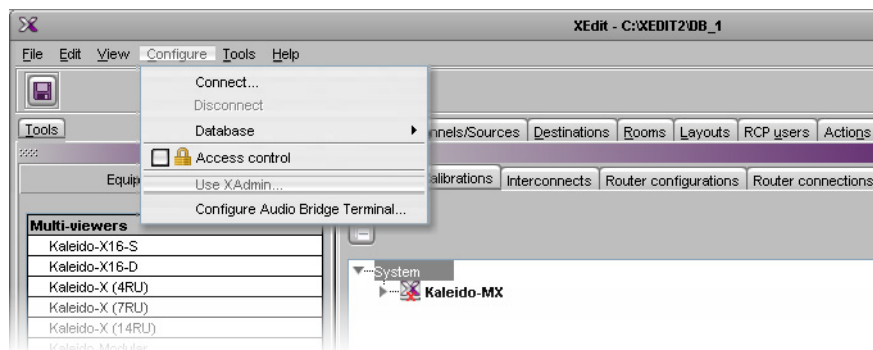

XEdit prompts you for the IP address of the multiviewer you wish to access.

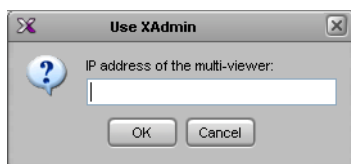

- 2 Type the IP address, and then click **OK**.  
Your default Web browser opens.
- 3 If you see a security warning, or a certificate error message, then refer to [Registering your Multiviewer's Security Credentials with your Browser](#), on page 489.
- 4 If the "Log in to XAdmin" page appears, type the password, and then click **Log in**.

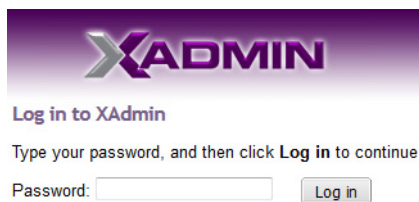

- 5 **Internet Explorer users:** If a blank page appears, then refer to [Enabling the Compatibility View in Internet Explorer 10](#), on page 498.  
The XAdmin Status and Options page appears. You can access all XAdmin features, by clicking the links, in the navigation area on the left of the page.

## Registering your Multiviewer's Security Credentials with your Browser

When you open your multiviewer's home page, or try to access XAdmin, your browser may report a certificate error (Internet Explorer), warn you about the site's security certificate (Chrome), or report an untrusted connection (Firefox). Follow the appropriate procedure below to register your multiviewer's security credentials with your browser:

- [Suppressing untrusted connection warning in Firefox](#), below
- [Suppressing certificate error in Internet Explorer or Chrome](#), on page 491

You will be then able to access your multiviewer's client applications without seeing the error message again, as long as the multiviewer's IP address does not change.

### Suppressing untrusted connection warning in Firefox

The first time you try to access XAdmin in Firefox, the browser may display the following page instead, prompting you to confirm the multiviewer's security credentials.



### This Connection is Untrusted

You have asked Firefox to connect securely to **10.5.6.11**, but we can't confirm that your connection is secure.

Normally, when you try to connect securely, sites will present trusted identification to prove that you are going to the right place. However, this site's identity can't be verified.

**What Should I Do?**

If you usually connect to this site without problems, this error could mean that someone is trying to impersonate the site, and you shouldn't continue.

- ▶ **Technical Details**
- ▶ **I Understand the Risks**

#### To register your multiviewer's security credentials with Firefox

- 1 Click **I understand the Risks**, at the bottom of the page.

The message expands.

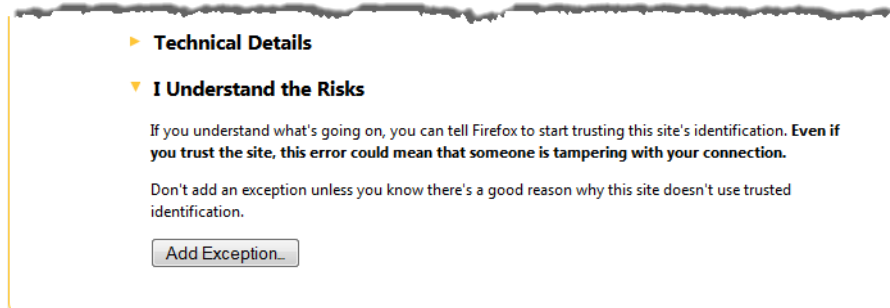

- ▶ **Technical Details**
- ▼ **I Understand the Risks**

If you understand what's going on, you can tell Firefox to start trusting this site's identification. **Even if you trust the site, this error could mean that someone is tampering with your connection.**

Don't add an exception unless you know there's a good reason why this site doesn't use trusted identification.

- 2 Click **Add Exception**.
- 3 In **Add Security Exception**, click **Confirm Security Exception**.

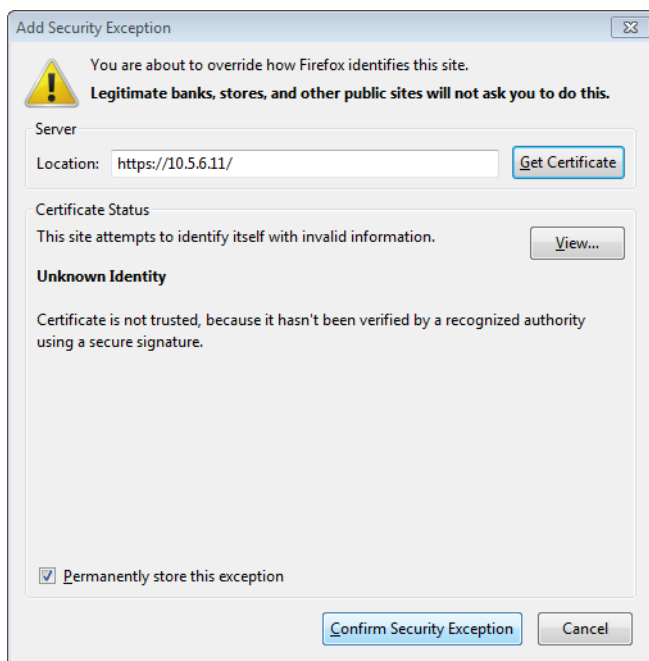

Your multiviewer's home page appears. You will now be able to access your multiviewer's client applications without seeing the warning. This will remain effective until the multiviewer's IP address is changed, in which case you will need follow the procedure again.

### Suppressing certificate error in Internet Explorer or Chrome

The first time you try to access XAdmin in Internet Explorer or Chrome, the browser may prompt you to confirm the multiviewer's security credentials.

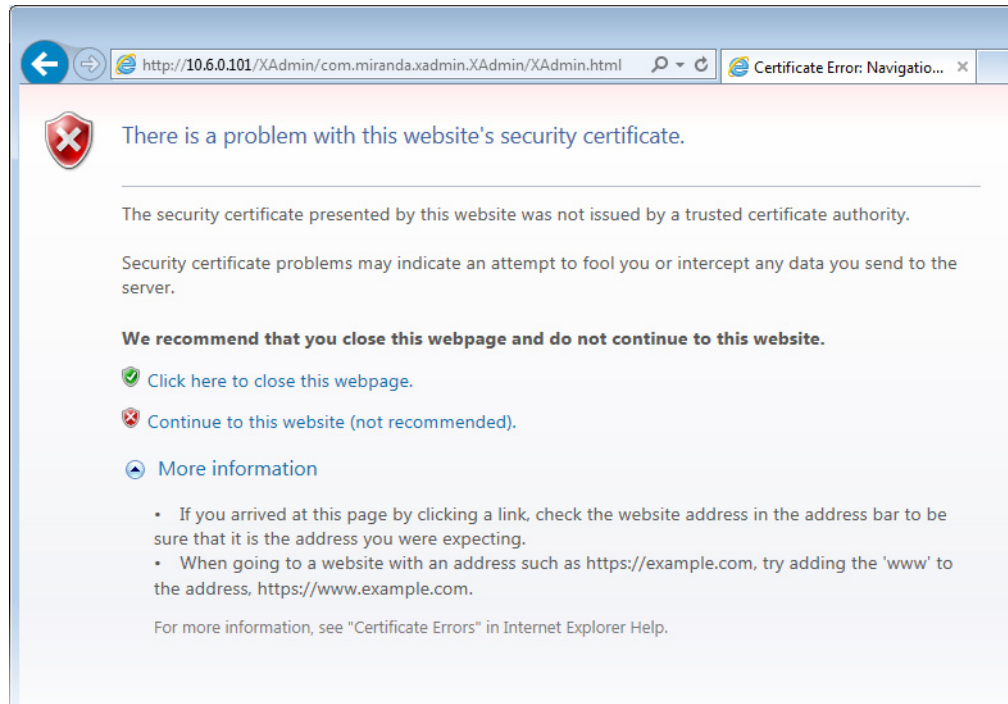

*Internet Explorer's security warning*

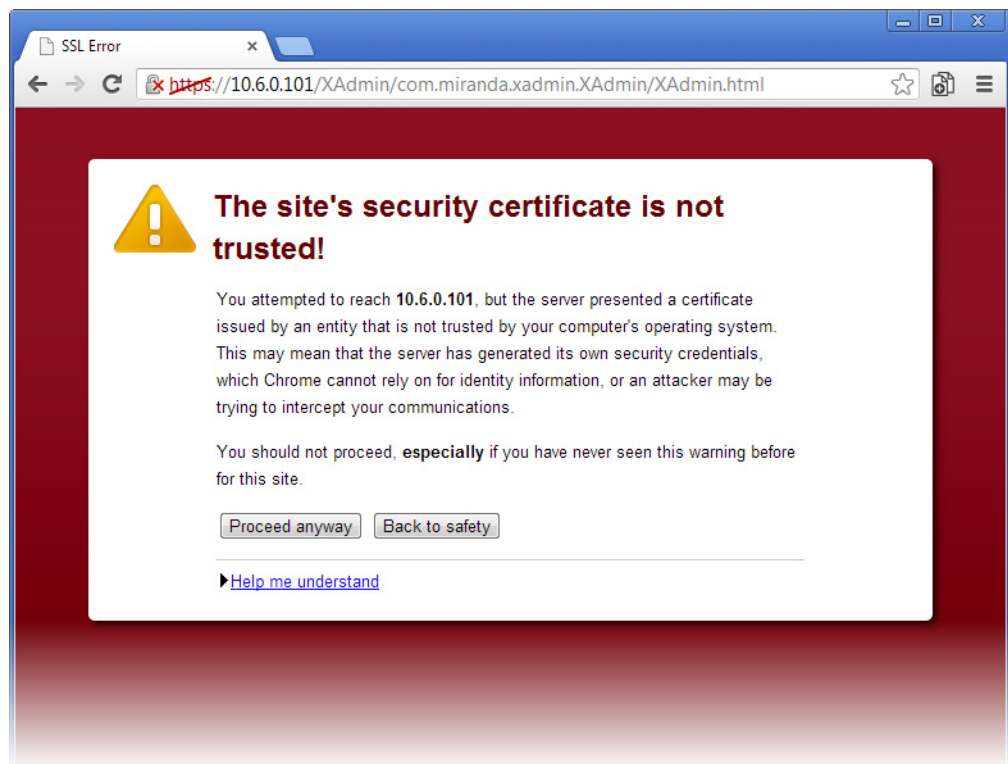

*Chrome's security warning*



Clicking **Continue to this website (not recommended)** (Internet Explorer), or **Proceed anyway** (Chrome) will let you access XAdmin but the browser's address bar will keep indicating that the multiviewer's identity is not verified. To suppress this warning, you need to perform the following, in Internet Explorer, *even if your preferred browser is Chrome*.

### To register your multiviewer's security credentials with Internet Explorer

- 1 Click **Continue to this website (not recommended)**.

The address bar now indicates the certificate error.



### Special notes for users of Internet Explorer 10

- If you see a blank page instead of XAdmin's Status and Options page, then see [Enabling the Compatibility View in Internet Explorer 10](#), on page 498.
- You must have administrator status to accept the certificate error. If your user account does not have administrator status, then close your browser and, before you open it again, right-click the Internet Explorer icon, and then click **Run as administrator**:

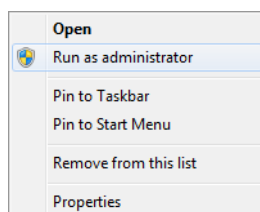

- 2 Click **Certificate error**.
- 3 In **Untrusted Certificate**, click **View certificates**.

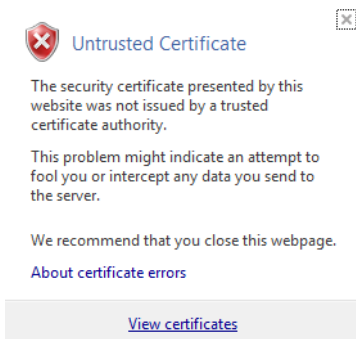

- 4 In **Certificate**, click **Install Certificate**.

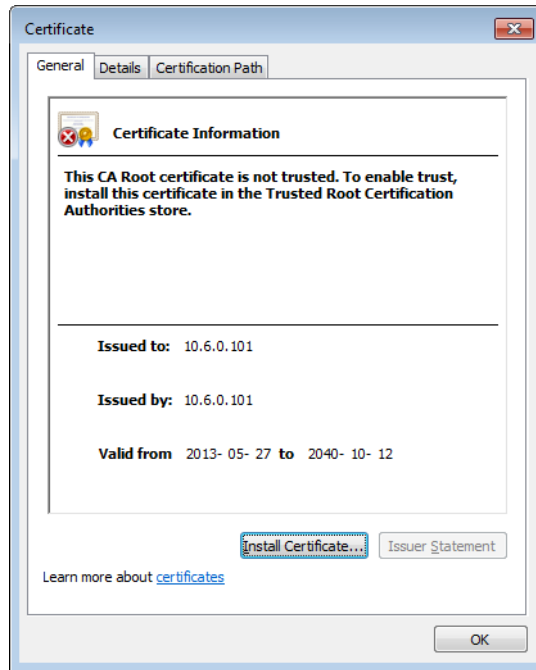

5 In Certificate Import Wizard, click Next.



6 In Certificate Import Wizard, click Place all certificates in the following store, and then click Browse.

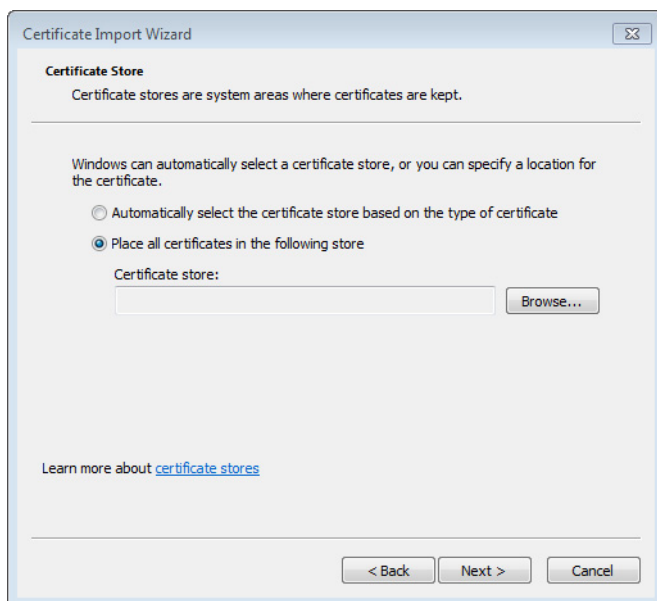

- 7 In **Select Certificate Store**, select **Trusted Root Certification Authorities**, and then click **OK**.

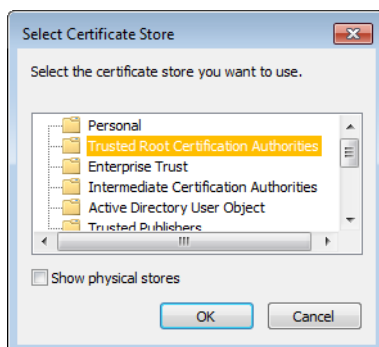

- 8 Back in **Certificate Import Wizard**, click **Next**.

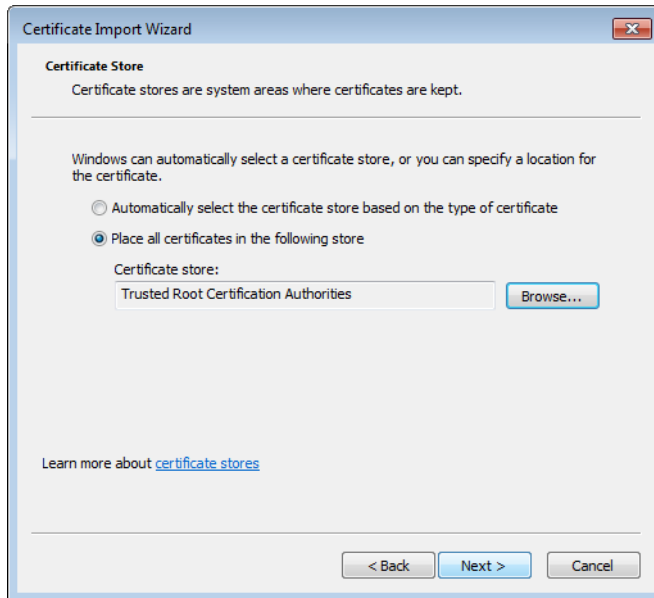

9 Click **Finish**.

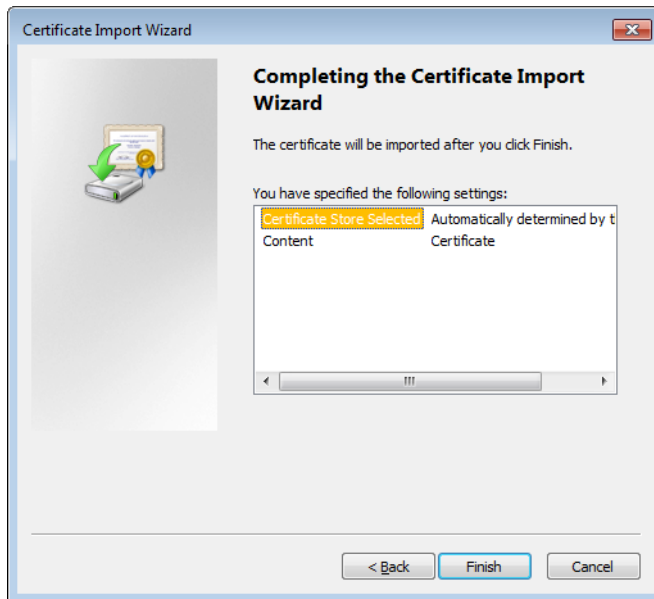

A security warning appears.

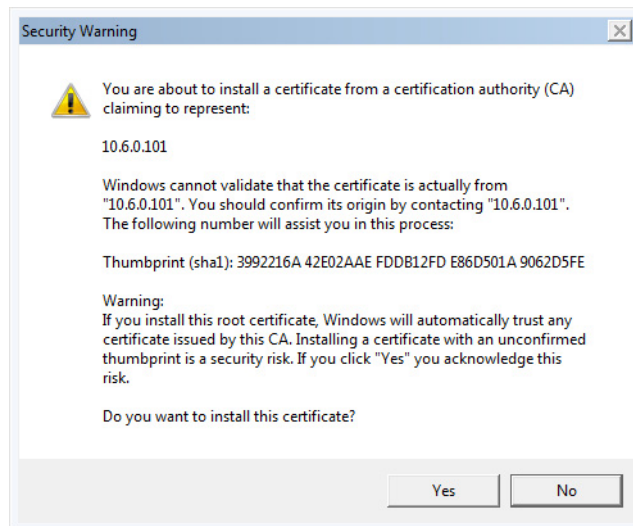

- 10 Click **Yes**.
- 11 **Certificate Import Wizard** reports that the import was successful.

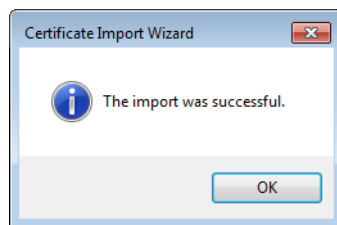

- 12 Click **OK** to dismiss the message, and then click **OK** to close the **Certificate** window.
- 13 Close all Internet Explorer (and Chrome, if any) windows, and then open your browser again.

You should now be able to access XAdmin, from your multiviewer home page without ever seeing the security warning again, unless the multiviewer's IP address is changed, in which case you will want to repeat this procedure.

---

#### Special note for users of Chrome

**Kaleido-X**, **Kaleido-X16**, and **KMV-3901/3911** multiviewers currently use an older version of Java to generate their certificate. For this reason, *every time you open Chrome and try to access XAdmin*, you may see a warning about the site's security certificate. Click **Proceed anyway**.

**Special note for users of Chrome (continued)**

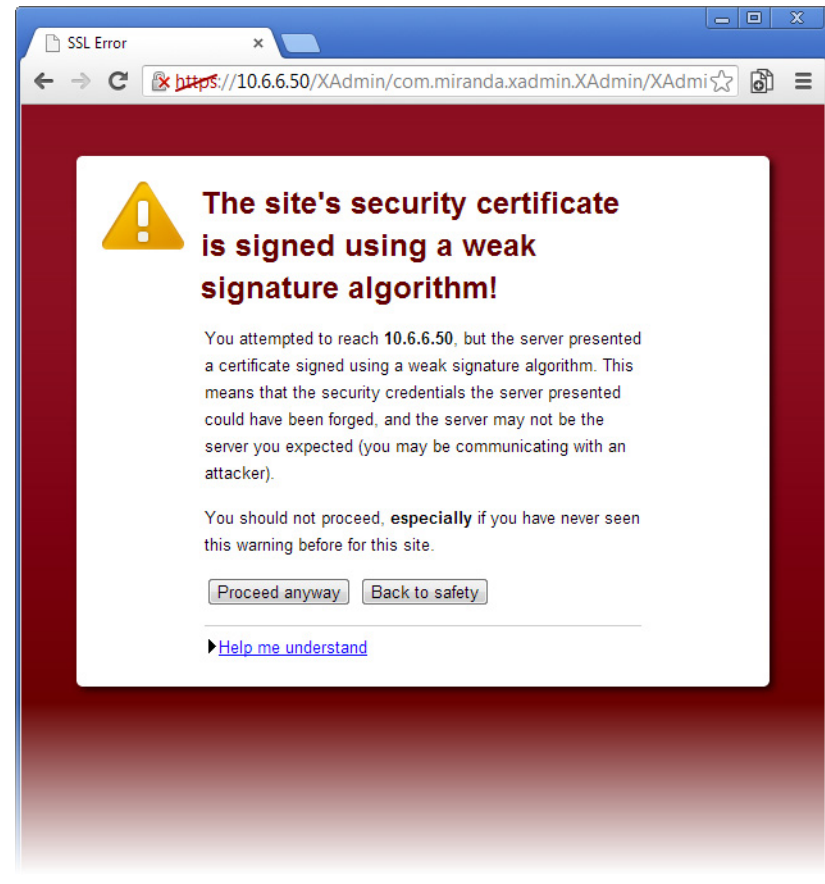

**Enabling the Compatibility View in Internet Explorer 10**

When you try to access XAdmin, from your multiviewer's home page, in *Internet Explorer 10*, you may see a blank page instead of XAdmin's Status and Options page.

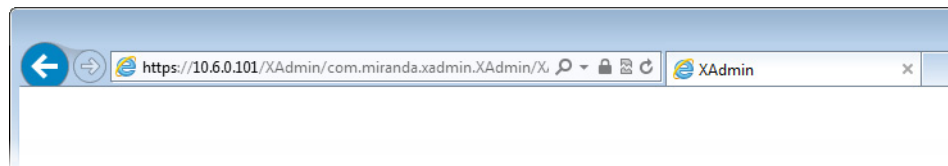

**To enable the compatibility view for your multiviewer's XAdmin Web client**

- Click the Compatibility View  button at the end of your browser's address bar. XAdmin's Status and Options page appears

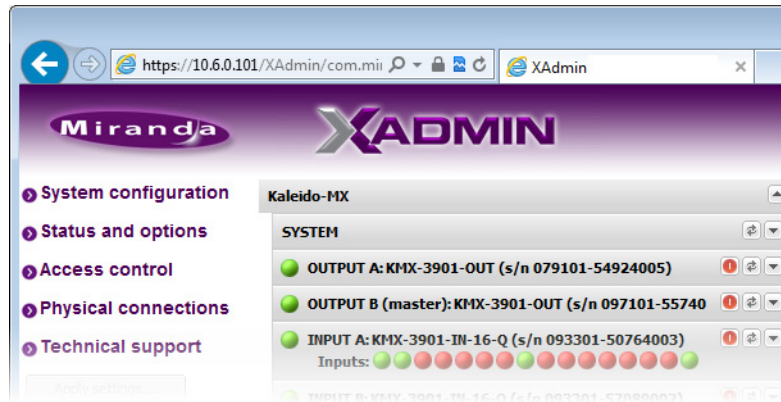

The Compatibility View mode will remain enabled for this multiviewer as long as its IP address does not change.

## XAdmin Access Control

XAdmin supports a simple authentication mechanism to prevent unauthorized users from modifying a multiviewer's system configuration.

### Enabling XAdmin Access Control

To enable access control in XAdmin

- 1 Open XAdmin. See [Opening XAdmin](#) on page 487.
- 2 Click **Access control**, in the navigation area on the left of the page.

The Access Control page appears.

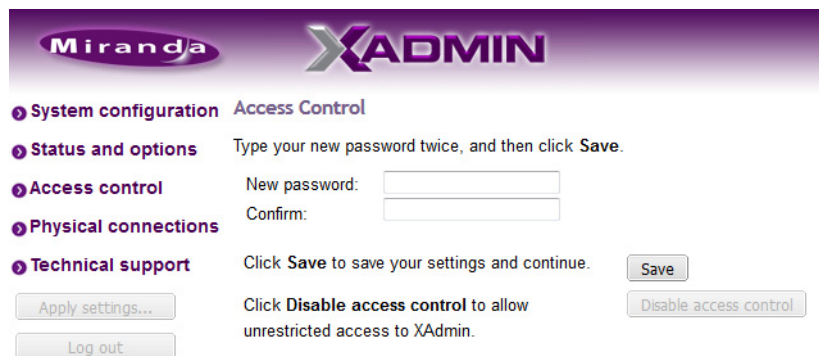

- 3 Type the password you wish to enforce in both the **New password** and the **Confirm** boxes.

The password must contain between 6 and 20 alphanumeric characters or symbols.

- 4 Click **Save**.

A confirmation message appears.

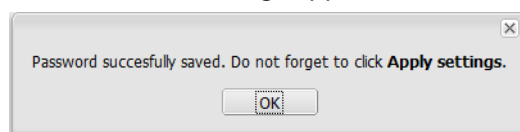

- 5 Click **OK** to close the message window.

The **Apply settings** button becomes available.

- ④ System configuration
- ④ Status and options
- ④ Access control
- ④ Physical connections
- ④ Technical support

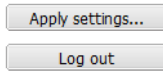

6 Click **Apply settings**.

XAdmin must upload the password to the multiviewer, for password enforcement to take effect. A progress indicator appears momentarily, followed by a confirmation message.

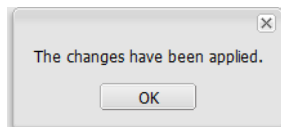

7 Click **OK**.

The Log in to XAdmin page appears. Other XAdmin sessions open against the same multiviewer are also redirected to the login page.

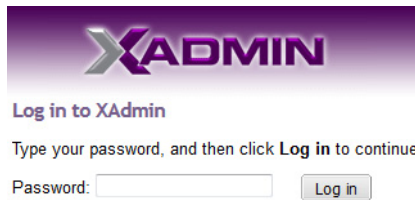

8 Type the password, and then click **Log in**.

The XAdmin Status and Options page appears.

9 Click **Log out**, when you are ready to close you session.

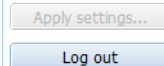
- ④ System configuration
  - ④ Status and options
  - ④ Access control
  - ④ Physical connections
  - ④ Technical support
- 

A confirmation message appears.

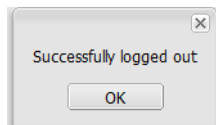

10 Click **OK**.

The login page appears. Only authorized users have access to XAdmin.



## Changing the XAdmin Password

To change the password used to prevent access to your multiviewer from XAdmin

- 1 Open XAdmin. See [Opening XAdmin](#) on page 487.
- 2 Click **Access control**, in the navigation area on the left of the page.  
The Access Control page appears.

- 3 Type the new password you wish to enforce in both the **New password** and the **Confirm** boxes.  
The password must contain between 6 and 20 alphanumeric characters or symbols.
- 4 Click **Save**.  
A confirmation message appears.

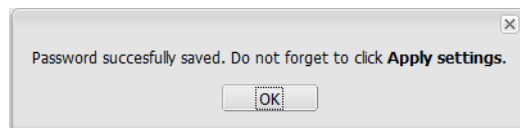

- 5 Click **OK** to close the message window.  
The **Apply settings** button becomes available.

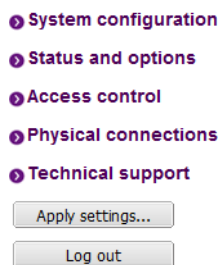

- 6 Click **Apply settings**.  
XAdmin must upload the password to the multiviewer, for the password change to take effect. A progress indicator appears momentarily, followed by a confirmation message.

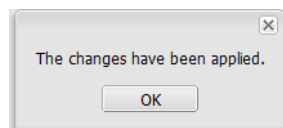

- 7 Click **OK**.  
The Log in to XAdmin page appears. Other XAdmin sessions open against the same multiviewer are also redirected to the login page.

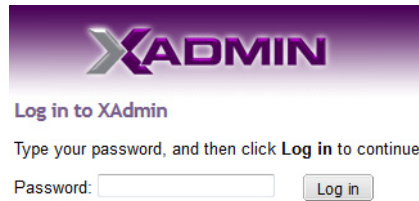

## Disabling XAdmin Access Control

### To disable access control in XAdmin

- 1 Open XAdmin. See [Opening XAdmin](#) on page 487.
- 2 Click **Access control**, in the navigation area on the left of the page. The Access Control page appears.



- 3 Click **Disable access control**. A confirmation message appears.

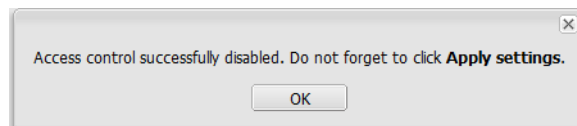

- 4 Click **OK** to close the message window, and then click **Apply settings**. A progress indicator appears momentarily, followed by a confirmation message.

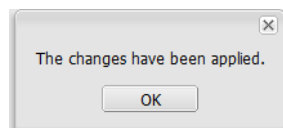

- 5 Click **OK**. Unrestricted access to XAdmin is restored, for this multiviewer.

## Closing a Password-Protected XAdmin Session

### To close your XAdmin session

- 1 Click **Log out**, in the navigation area on the left of the current page, when you are ready to close you session.

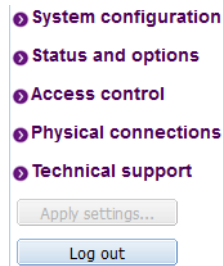

A confirmation message appears.

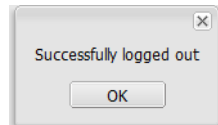

- 2 Click **OK**.

The login page appears. Only authorized users have access to XAdmin for this multiviewer.

## Restarting and Shutting Down a Kaleido-IP Multiviewer

### Restarting the Monitor Wall Software

To restart the monitor wall software

- 1 Open XAdmin. See [Opening XAdmin](#) on page 487.

The XAdmin Status and Options page appears.

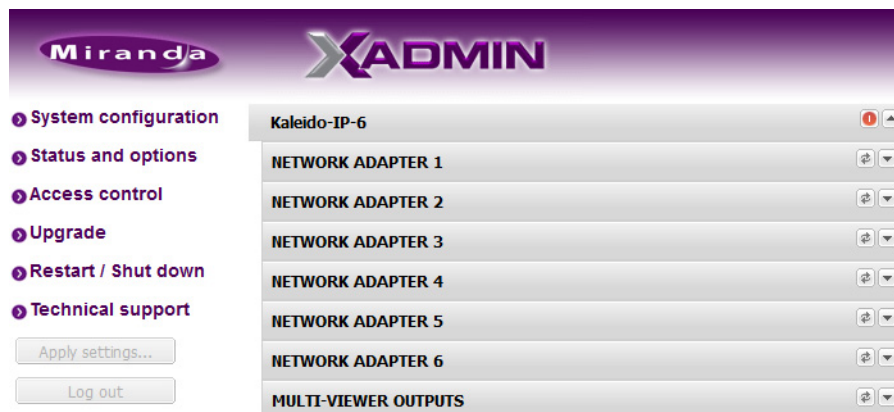

- 2 Click **Restart / Shut down** in the navigation area on the left of the page.

The Restart / Shut down page appears.



3 Click **Restart software**.

The system prompts you to confirm.

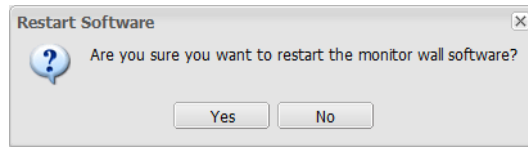

4 Click **Yes** to proceed.

Your multiviewer's operating system will shut down, and then start again. This may take a while.

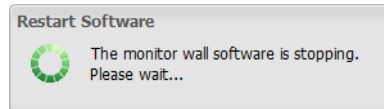

Once the monitor wall software has restarted, the system notifies you.

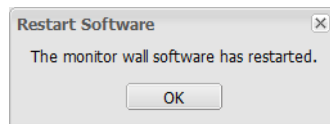

5 Click **OK**.

The XAdmin Status and Options page appears.

## Restarting a Kaleido-IP Multiviewer

### To restart a Kaleido-IP multiviewer

1 Open XAdmin. See [Opening XAdmin](#) on page 487.

The XAdmin Status and Options page appears.

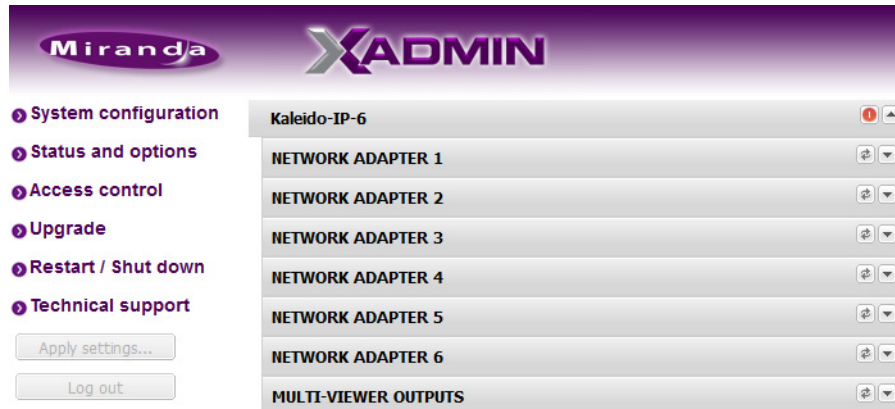

2 Click **Restart / Shut down** in the navigation area on the left of the page.

The Restart / Shut down page appears.

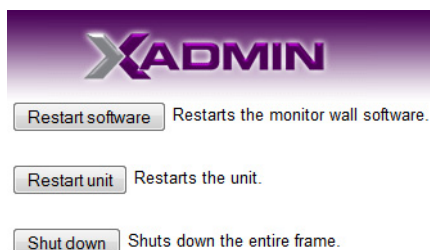

3 Click **Restart unit**.

The system prompts you to confirm.

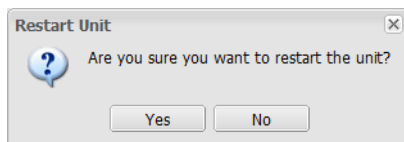

4 Click **Yes** to proceed.

Your multiviewer will shut down, and then start again, during which time you can observe messages associated with the Linux shutdown and boot sequences on the monitor wall display connected to Head 1. This may take a while.

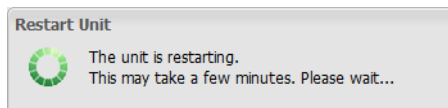

Once the multiviewer has restarted, the system notifies you.

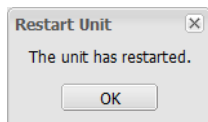

5 Click **OK**.

The XAdmin Status and Options page appears.

---

**Note:** Clicking the “Reset multiviewer” button on the Status and Options page for a Kaleido-IP is equivalent to the above procedure except that, in the first case, you get no feedback from XAdmin.

---

## Shutting Down a Kaleido-IP Multiviewer

---

**Note:** The Kaleido-X software does not support activating a soft shutdown from the Kaleido-IP frame’s power button. Should you be unable to access XAdmin, then perform a hard shutdown by pressing and holding the power button.

---

### To shut down a Kaleido-IP multiviewer

1 Open XAdmin. See [Opening XAdmin](#) on page 487.

The XAdmin Status and Options page appears.

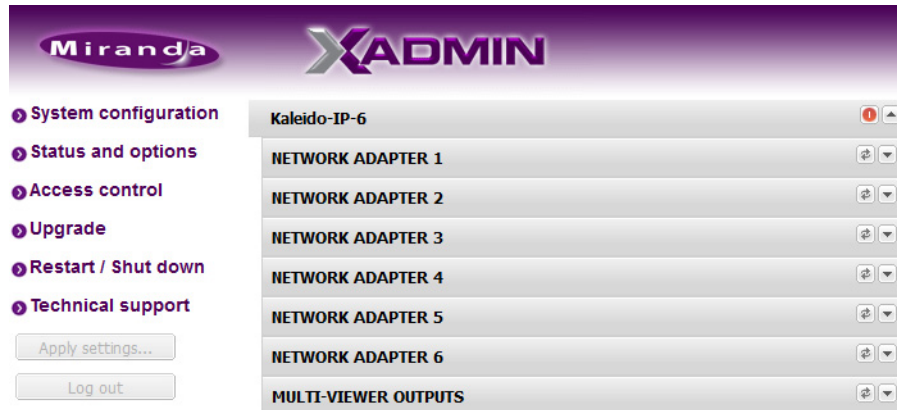

- 2 Click **Restart / Shut down** in the navigation area on the left of the page.  
The Restart / Shut down page appears.



- 3 Click **Shut down**.  
The system prompts you to confirm.

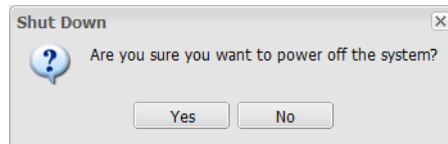

- 4 Click **Yes** to proceed.  
Your multiviewer will perform a clean shut down, during which time you can observe messages associated with the Linux shutdown sequence on the monitor wall display connected to Head 1.

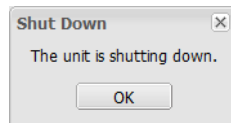

- 5 Click **OK** to dismiss the confirmation message.

## Configuring Head Streaming on a Kaleido-IP

---

**Note:** The Kaleido-IP supports head streaming, as an option. It is not yet possible to enable or verify options in XAdmin's Status and Options page, for Kaleido-IP multiviewers. Contact Technical Support for activation and configuration instructions (see [Contact Us](#), on page 529).

---

### To configure head streaming

- 1 Open XAdmin (see [Opening XAdmin](#), on page 487).
- 2 Click **Head streaming**, in the navigation area on the left of the page.  
The Head Streaming Configuration page appears.

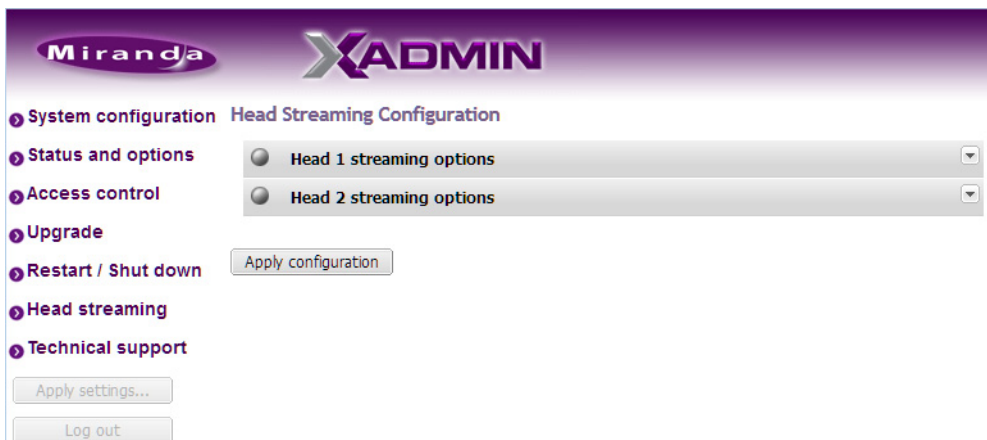

- 3 Expand the streaming options section for the head you wish to configure.

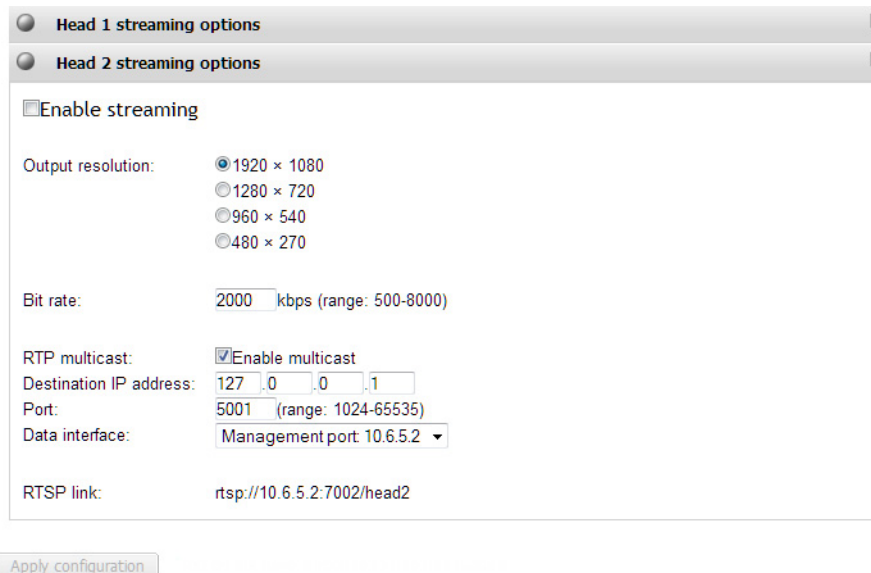

- 4 Enable streaming and configure the appropriate parameters for your purposes.

**Note:** If the streaming output is meant to feed a Kaleido-IP, the following combinations should ensure good video quality on the monitor wall:

- 1920×1080 at 8000 kbps
- 1280×720 at 5000 kbps
- 960×540 at 3000 kbps
- 480×270 at 15000 kbps

- 5 Click **Apply configuration**.  
A message appears confirming that the configuration has been applied.
- 6 Click **OK** to dismiss the message.

## Configuring Virtual Network Adapters on a Kaleido-IP

### To add virtual network adapters on a Kaleido-IP

- 1 Open XAdmin (see [Opening XAdmin](#), on page 487).
- 2 Click **System configuration**, in the navigation area on the left of the page.  
The System Configuration page appears.

**General**

System name:

**Ethernet**

Management IP address:

Network mask:

Default gateway:

Detected link mode: 100Mbps full-duplex

Configured link mode:  ▼

**Data port:**  **Enabled**

IP address:

Network mask:

Detected link mode: 1000Mbps full-duplex

Configured link mode:  ▼

**Virtual LAN configuration**

**DNS configuration**

**Font configuration**

**Date and Time**

Current date and time: Monday, September 15, 2014 05:34:22 PM UTC-4

Data and time format: English (United States) ▼

- 3 Click **Configure**, under Virtual LAN configuration.  
The “Virtual LAN adapters configuration” page appears.



Virtual LAN adapters configuration

```
# VLAN configuration file
#
# LAN 1-6, VLAN <ID>, <IP v4>, <netmask>
# ex: LAN 2, VLAN 10, 169.254.2.10, 255.255.0.0
#LAN 2, VLAN 111, 169.254.61.11, 255.255.255.0
#LAN 2, VLAN 101, 169.254.61.1, 255.255.255.0
#LAN 2, VLAN 11, 169.254.60.1, 255.255.255.0
#LAN 2, VLAN 201, 169.254.62.1, 255.255.255.0
#LAN 2, VLAN 211, 169.254.62.11, 255.255.255.0
#LAN 2, VLAN 301, 169.254.63.1, 255.255.255.0
#LAN 2, VLAN 311, 169.254.63.11, 255.255.255.0
#LAN 2, VLAN 401, 169.254.64.1, 255.255.255.0
#LAN 2, VLAN 411, 169.254.64.11, 255.255.255.0
#LAN 2, VLAN 501, 169.254.65.1, 255.255.255.0
#LAN 2, VLAN 511, 169.254.65.11, 255.255.255.0
#LAN 2, VLAN 502, 169.254.65.2, 255.255.255.0
#LAN 2, VLAN 512, 169.254.65.12, 255.255.255.0
#LAN 2, VLAN 601, 169.254.66.1, 255.255.255.0
#LAN 2, VLAN 611, 169.254.66.11, 255.255.255.0
#LAN 2, VLAN 30, 169.254.60.30, 255.255.255.0
```

Apply configuration

4 Edit the VLAN configuration file as required. Refer to the Help pane for guidelines, if needed.

5 Click **Apply configuration**.

A message appears prompting you to restart the software.

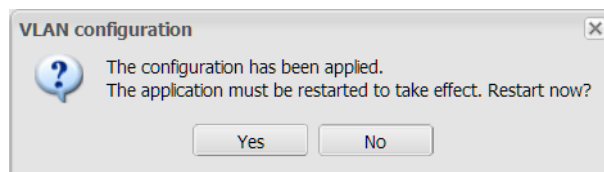

6 Click **Yes**.

A message appears confirming that the software has restarted.

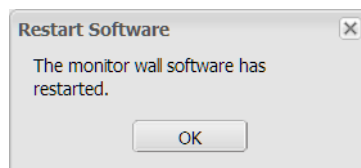

7 Click **OK** to dismiss the message.

## Adding Fonts to a Kaleido-IP

### To add fonts on a Kaleido-IP

- 1 Open XAdmin (see [Opening XAdmin](#), on page 487).
- 2 Click **System configuration**, in the navigation area on the left of the page.  
The System Configuration page appears.

**General**

System name:

**Ethernet**

Management IP address:      
Network mask:      
Default gateway:       
Detected link mode: 100Mbps full-duplex  
Configured link mode:  ▼

Data port:  Enabled

IP address:       
Network mask:       
Detected link mode: 1000Mbps full-duplex  
Configured link mode:  ▼

**Virtual LAN configuration**

**DNS configuration**

**Font configuration**

**Date and Time**

Current date and time:   
Date and Time Format:

- 3 Click **Configure**, under Font configuration.  
The “Font configuration” page appears.



- 4 Click **Choose a font to upload**.  
A file chooser window appears.
- 5 Navigate to the font file you wish to upload, select it, and then click **Open**.

**Note:** The Kaleido-X software supports true type fonts (TTF) only.

A progress indicator appears momentarily, followed by a confirmation message.

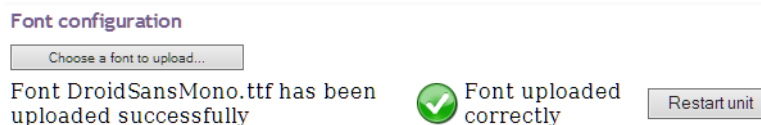

- 6 Click **Restart unit**.  
The system prompts you to confirm.

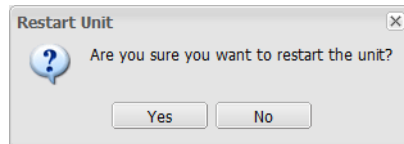

- 7 Click **Yes** to proceed.

Your multiviewer will shut down, and then start again. This may take a while.

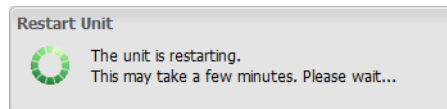

Once the multiviewer has restarted, the system notifies you.

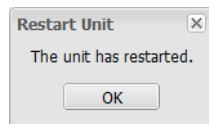

- 8 Click **OK**.

The XAdmin Status and Options page appears.

- 9 Make sure the same font is available on the client PC or laptop where you use XEdit. (To install a font on Windows 7, right-click the TTF file, and then click **Install**.)
- 10 Close XEdit and then open it again (see [Opening the XEdit Software](#), on page 73).

The new fonts are now available, if you:

- Connect XEdit to the multiviewer (see [Using XEdit Online](#), on page 75).
- Download the database from the multiviewer to your local workspace ([Importing a Database](#), on page 79).

#### IMPORTANT

Upgrading or reinstalling the Kaleido-X software removes all additional fonts you may have uploaded to the multiviewer. In such case, you will need to repeat this procedure.

## Configuring Power Supply Redundancy on a Kaleido-X16

Power supply redundancy is an option on the Kaleido-X16, which can ship with a single PSU. In order to avoid having the system dashboard display unnecessary alarms, there is a check box in XAdmin to indicate the presence of the second PSU. By default, this option is selected (both PSUs are monitored). Removing the check mark will stop the monitoring of alarms for PSU B (its status is set to disabled, and therefore will not appear on the dashboard).

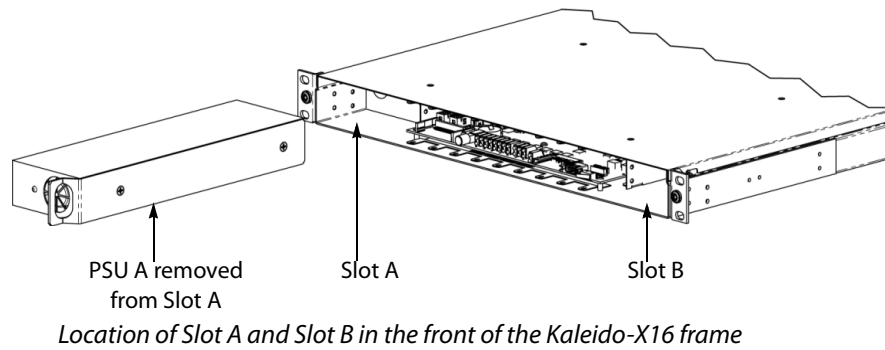

### To configure the PSU B Installed option in XAdmin

- 1 Open XAdmin. See [Opening XAdmin](#) on page 487.  
The XAdmin Status and Options page appears.

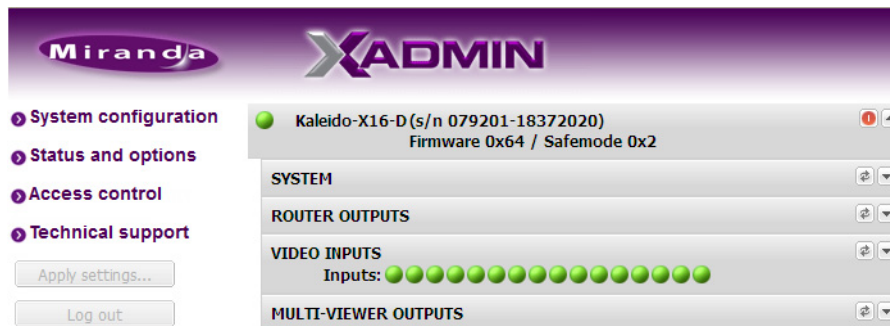

- 2 In the SYSTEM heading row, click the Expand details arrow (▾).  
A list of system details and statuses appears below the System heading row.
- 3 At the top of the list, select or clear **PSU B Installed**, as required.

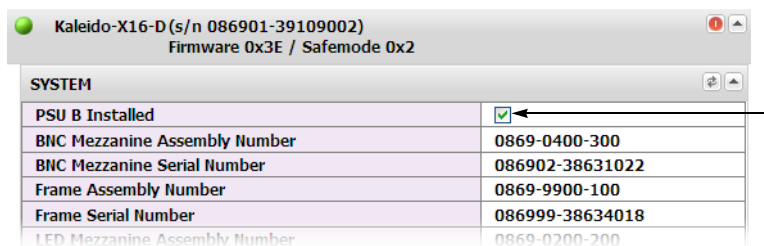

The change is applied immediately. The **Power Supply B Status** indicator turns gray, indicating that probing is disabled for this alarm.

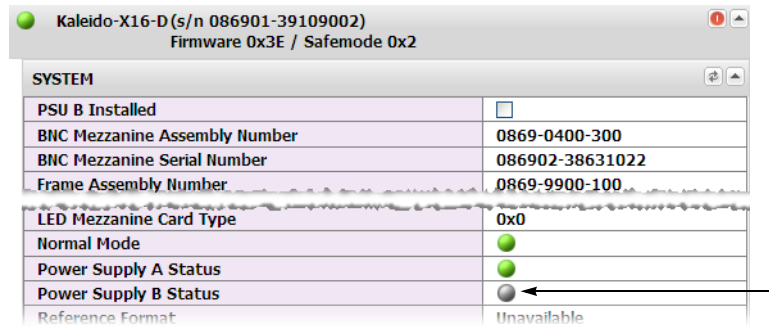
**IMPORTANT**

The system behavior after selecting or clearing the **PSU B Installed** check box is as follows:

- When you select the **PSU B Installed** check box, the system publishes a warning that PSU B has failed if there is no PSU in *Slot B*. Do this when you have two PSUs installed in your frame.
- When you clear the **PSU B Installed** check box, the system does not generate a warning that PSU B has failed if there is no PSU in *Slot B*. Do this when you have only one PSU installed in your frame.

## Obtaining EDID Data from Displays when Using the DXF-100 Interface

The DXF-100 is a transmitter/receiver combination that allows a digital flat panel display to be located up to 1,000 meters (3,300 feet) away from the signal source. The transmitter and receiver are interconnected by a single multimode optical fiber, and connect to the source and display using DVI connectors.

The DXF-100 must be configured for its target display, *before* it is connected to the multiviewer, otherwise the Extended display identification data (EDID) information listed in XAdmin's Status and Options page for the corresponding output card will not reflect the actual values for the target display. XAdmin would not be reporting the actual timing data from the display, but default values corresponding to the maximum resolution supported by the DXF-100, i.e. 1920 × 1200. The DXF-100 interface is unidirectional from the transmitter (multiviewer) to the receiver (display). For XAdmin to show timing data from the display, the EDID information needs to be transmitted in the reverse direction: from the display to the multiviewer.

### To obtain a display's timing information in XAdmin

- Connect the display directly to the DVI output of the multiviewer, by using a copper cable. (This is not always practical, since the display can be far or mounted on a wall.)
- Alternatively, connect the DXF-100 transmitter to the DVI input connector on the display, and then connect it to its power supply. The LED will flash for a few seconds while the transmitter reads and stores the EDID information from the display. When the LED stops flashing, disconnect the transmitter from the display and reconnect it to the multiviewer. The EDID information from the display will now be visible in XAdmin. The EDID information from the display will now be visible to the multiviewer. If the

multiviewer is configured to adapt itself to the native resolution of the display, the resolution for the output will change automatically.

---

#### Notes

- Grass Valley offers a more versatile bidirectional interface, the DXF-200 DVI/HDMI Optical Extension System, which has superseded the DXF-100 interface. For more information on the DXF-200, contact your Grass Valley sales representative.
  - As of Kaleido-X version 4.10, the EDID auto-detection feature is enabled by default in order to facilitate the initial setup of a Kaleido-X system.
  - Prior to Kaleido-X v. 3.00, EDID information was only reported for the master KXO-Dual card. In more recent versions, every KXO-Dual/KXO-Dual3 card reports the EDID information for its associated displays.
- 

For more information on the DXF-100 interface, refer to the *DXF-100 DVI Fiber Optic Interface User's Manual* (part no. M792-9500-101).

## Servicing

### Generating a System Snapshot

To generate a system snapshot

- 1 Open XAdmin. See [Opening XAdmin](#) on page 487.

The XAdmin Status and Options page appears.

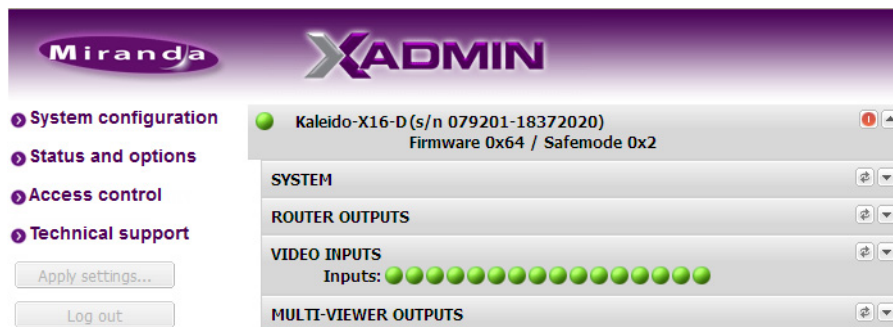

- 2 Click the **Technical support** link in the navigation pane.

The Contact Technical Support page appears.

**Miranda XADMIN**

- System configuration
- Status and options
- Access control
- Technical support

Buttons: Apply settings..., Log out

**Contact Technical Support**

<b>Americas</b> 9:00 a.m. - 9:00 p.m. (EST) Telephone: 1-800-224-7882 Fax: +1 514 335 1614 support@miranda.com	<b>Asia</b> 9:00 a.m. - 5:00 p.m. (GMT+8) Telephone: +852 2539 6987 Fax: +852 2539 0804 asiotech@miranda.com
<b>Europe, Middle East, Africa, UK</b> 9:00 a.m. - 6:00 p.m. (GMT) Telephone: +44 118 952 3444 Fax: +44 118 952 3401 eurotech@miranda.com	<b>China</b> Telephone: +86 10 5873 1814 asiotech@miranda.com
<b>France</b> 9:00 a.m. - 5:00 p.m. (GMT+1) Telephone: +33 1 55 86 87 88 Fax: +33 1 55 86 00 29 eurotech@miranda.com	<b>EMERGENCY After Hour (Global)</b> Toll Free (US and Canada): 1-800-224-7882 Telephone: +1 514 333 1772

**System snapshot**  
Click the following link to download a **system snapshot**, that can be used by Technical Support. [Click to download](#), [Click here ... or here](#)

**Memory snapshot**  
Click the following link to view a **memory snapshot** that can be used by Technical Support. [Click to view](#).

3 Click **system snapshot**.

The system snapshot generation may take a few moments, after which your browser prompts you to save the resulting compressed folder to your hard drive.

4 Browse to the location where you wish to save the ZIP file, and then click **Save**.

The compressed system snapshot folder contains information that can be used by Technical Support for troubleshooting purposes.

### Viewing a Multiviewer's Status Information

To view the status information for a multiviewer

- 1 Open XAdmin. See [Opening XAdmin](#) on page 487.

The Status and Options page appears, displaying a list of all cards and their statuses.

**Miranda XADMIN**

- System configuration
- Status and options
- Access control
- Technical support

Buttons: Apply settings..., Log out

**Kaleido-X16-D (s/n 079201-18372020)**  
Firmware 0x64 / Safemode 0x2

<b>SYSTEM</b>	[Refresh] [Dropdown]
<b>ROUTER OUTPUTS</b>	[Refresh] [Dropdown]
<b>VIDEO INPUTS</b>	[Refresh] [Dropdown]
Inputs: ●●●●●●●●●●●●●●●●	
<b>MULTI-VIEWER OUTPUTS</b>	[Refresh] [Dropdown]



- In the case of a Kaleido-X (7RU) or Kaleido-X (14RU), cards are presented in the order they appear, from left to right when looking at the front of the chassis.
- In the case of a Kaleido-X (4RU), cards are presented in the order they appear, starting from the top left corner down, and again from the top right corner, when looking at the front of the chassis.
- Some heading rows may show a card type, serial number, firmware and safe mode versions, a module status indicator, and input signal status indicators.
- The module status indicator shows whether the card (or module) is running normally (green) or in safe mode (red).
- The signal status indicators reveals the presence of a valid input signal at the corresponding connector.

2 Move the pointer to an input signal status indicator to view the associated signal format.

The screenshot shows the XAdmin interface with several modules listed. A mouse cursor is hovering over a red status indicator for 'INPUT B: KXI-16HSV (s/n 079401-19797003)'. A tooltip is displayed, showing 'Video 14: 1080i 50Hz / 25Hz(PSF)'. Labels with arrows point to various elements: 'Status indicator' points to a green dot, 'Card type' points to 'KXI-16HSV', 'Serial number' points to '(s/n 079401-19797007)', 'Version information' points to 'Firmware 0x8F / Safemode 0x6F', 'Input signal status' points to a red dot in the 'Inputs' row, and 'Input signal format' points to the tooltip text.

Module	Status	Firmware	Safemode
OPTION B: Empty	Empty	-	-
INPUT A: KXI-16HSV (s/n 079401-19797007)	Green	0x8F	0x6F
INPUT B: KXI-16HSV (s/n 079401-19797003)	Red	0x8F	0x6F
OUTPUT A: KXO-DUAL (s/n 079201-18372006)	Green	0x65	0x53
OUTPUT B (master): KXO-DUAL (s/n 079201-18900026)	Green	0x65	0x53

Note: The Kaleido-X software does not distinguish between 1080PsF25 and 1080i50, and neither between 1080PsF29.97 and 1080i59.94. Both 1080PsF25 and 1080i50 are reported as 1080i50, and both 1080PsF29.97 and 1080i59.94 are reported as 1080i59.94, on the monitor wall and in XAdmin's Status and Options page.

3 Click the arrow button at the end of each heading row to view detailed information about the associated module.

The screenshot shows the XAdmin interface with several modules. A mouse cursor is hovering over the 'Expand details' button (a downward arrow) at the end of the 'INPUT A: KXI-16HSV (s/n 079401-17914037)' row. Labels with arrows point to: 'Expand details' (the button), 'Refresh' (a circular arrow icon), 'Reset card' (a square icon with a diagonal line), and 'Master card status indicator' (a green dot next to 'OUTPUT A (master): KXO-DUAL (s/n 079201-19722004)').

In the case of a Kaleido-X, Kaleido-MX, or Kaleido-Modular-X multiviewer model, you can identify which output card currently assumes the *software master* role (and is thus assigned the multiviewer's IP address) by looking for the word "master" next to the card's identifier, for example: "OUTPUT A (master)".



## Viewing Version Information

To view your multiviewer's system and software version information

- 1 Open XAdmin. See [Opening XAdmin](#) on page 487.

The XAdmin Status and Options page appears.

- The Kaleido-X software version appears on the Web browser's title bar or tab label.
- In the case of a Kaleido-X or Kaleido-X16 multiviewer, the firmware and safe mode package numbers appear both in the relevant heading row, and within the detailed status information.

The screenshot shows the XAdmin web interface. The browser title bar displays "XAdmin - 6.20 build 4602". The address bar shows the URL "http://10.5.5.180/XAdmin/com.miranda.xadmin.XAdmin/XAdmin.html#Status". The page header features the "Miranda XADMIN" logo. On the left, there is a navigation menu with "System configuration", "Status and options", and "Technical support". The main content area is titled "Kaleido-X (7RU) Frame" and lists several modules with their serial numbers, firmware, and safemode versions. Callouts indicate that the software version is shown in the browser title bar and that firmware and safemode information is provided in the module headings.

Module	Serial Number	Firmware	Safemode
GPI/GENLOCK: KXA-GPI-GEN	(s/n 079899-17912001)	0x35	0x36
OPTION A: KXO-24Router	(s/n 079701-18536003)	0x40	0x43
OPTION B: KXO-24Router	(s/n 079701-18536029)	0x40	0x43
INPUT A: KXI-16HSV	(s/n 079401-17914013)	0xD0	0x6F
INPUT B: KXI-16SV	(s/n 088916-45298004)	0x25	0x3
INPUT C: KXI-16SV	(s/n 079412-19794008)	0x97	0x38
INPUT D: KXI-16HSV	(s/n 079401-19797009)	0xD0	0x6F
INPUT E: Empty			
INPUT F: Empty			

Status and Option page for a Kaleido-X (7RU) multiviewer

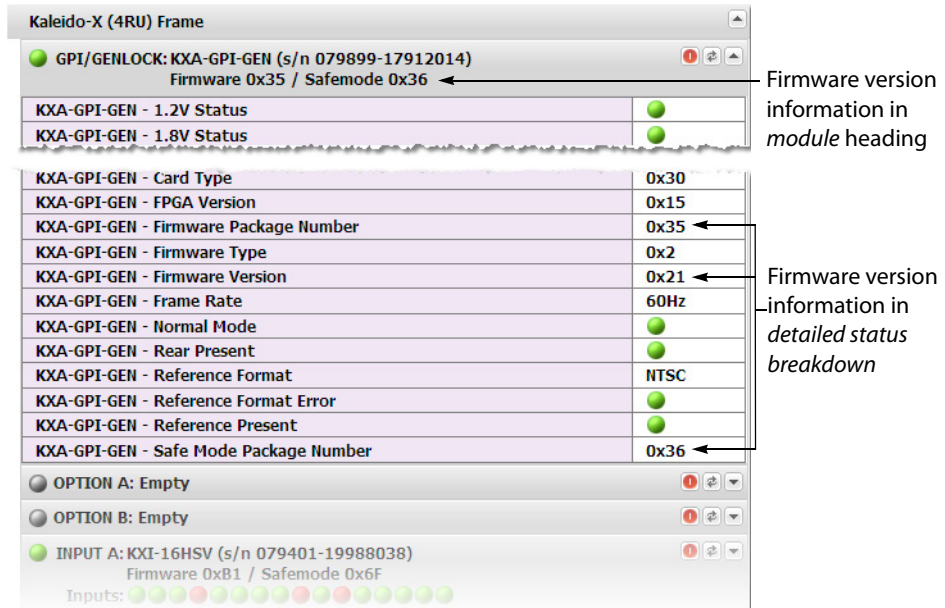

Status and Option page for a Kaleido-X (4RU) multiviewer

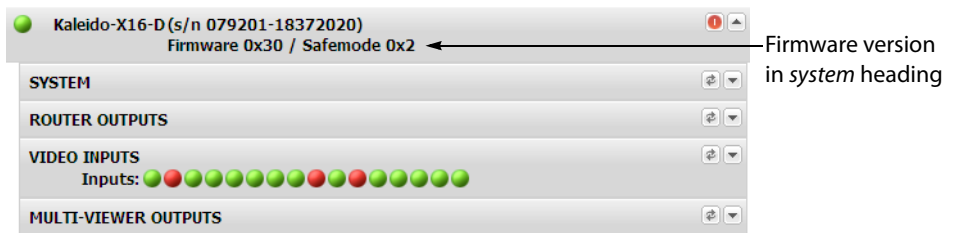

Status and Option page for a Kaleido-X16 multiviewer

## Upgrading your Multiviewer System

For information on upgrading your multiviewer system, please refer to the Release Notes published with the Kaleido-X software version you wish to use. In addition to the latest Kaleido-X documentation you can download Release Notes for previous versions of the Kaleido-X software, from Grass Valley's support portal.

# index

## Index

## 0–9

0 VU ..... 139–140  
3D monitoring ..... 182

## A

ABT ..... 441  
AC-3 metadata ..... 157  
Access control  
    XAdmin ..... 499  
    XEdit ..... 77–78  
Actions  
    assigned to monitors ..... 303  
    background actions ..... 304  
    trigger ..... 60  
    trigger audio monitoring ..... 62, 64  
AFD  
    about ..... 219  
    configuration ..... 244  
Alarm monitors  
    about ..... 218  
    configuration ..... 274  
Alarms  
    about ..... 151  
    browser ..... 152  
    debouncing, about ..... 154  
    debouncing, configuration ..... 162  
    global ..... 155  
    GSM ..... 151  
    latch, about ..... 31  
    levels, in logical source ..... 186  
    lookup ..... 153  
    monitor ..... 218  
    providers ..... 151, 153, 187  
    reporting behavior ..... 274  
    scheduling ..... 154  
    SNMP ..... 173  
    status ..... 152  
    status indicator ..... 156  
    sub-alarms ..... 156  
    threshold ..... 159

### Alarms (*continued*)

    virtual ..... 151, 155  
ALM. *See* Audio monitors.  
Andromeda ..... 387  
Any-source multicast transport stream ..... 101  
ASM transport streams ..... 101  
Aspect ratio  
    about ..... 219  
    AFD ..... 244  
    automatic ..... 219, 244  
    calibration ..... 141  
    changing ..... 42  
    of a room display ..... 211  
    subtitling monitor ..... 281  
    WSS ..... 244  
Assigning  
    alarms to logical sources ..... 186  
    audio outputs to RCP users ..... 318  
    colors to logical sources ..... 188  
    full screen layouts to RCP users ..... 318  
    logical sources to monitors ..... 51  
    room layouts to RCP users ..... 317  
    timers to RCP users ..... 320  
    timers to rooms ..... 316  
Audio  
    level meter ..... 218  
    metadata ..... 138  
    monitor ..... 218  
    monitoring delay ..... 129  
    output, assigning to RCP users ..... 318  
    reference level ..... 139–140  
Audio Bridge Terminal ..... 441, 469  
Audio level meters, scale ..... 257  
Audio monitoring  
    triggered by actions ..... 62, 64  
    triggered from the Kaleido-RCP2 ..... 63  
    triggered from the RCP-200 ..... 63  
Audio monitors  
    about ..... 218  
    scale ..... 257  
Audio programs  
    about ..... 122  
    calibration ..... 132

- Audio scales  
 backup ..... 83  
 configuration ..... 256–257  
 Auto-layout ..... 230  
 Automatic aspect ratio ..... 244
- B**
- Background actions ..... 304  
 Background images  
 clock logo ..... 288  
 custom safe area ..... 239  
 DVI input ..... 234  
 on layouts ..... 233  
 Backup  
 audio scales ..... 83  
 creating ..... 83  
 resolutions ..... 83  
 retrieving ..... 84
- C**
- CAD. *See* Metadata monitors.  
 Calibrating  
 0 VU ..... 139–140  
 audio metadata ..... 138  
 audio monitoring delay ..... 129  
 audio programs ..... 132  
 automatic aspect ratio ..... 141  
 brightness ..... 125  
 closed captioning ..... 143  
 color saturation ..... 126  
 contrast ..... 125  
 detail enhancement ..... 142  
 DVI keying mode ..... 128  
 dynamic range ..... 142  
 GPI lines ..... 150  
 loudness (audio programs) ..... 133  
 loudness (legacy) ..... 136  
 metadata holding time ..... 145  
 router field selection switching ..... 148  
 router output signal reclocking ..... 149  
 subtitling ..... 143  
 Calibration  
 about ..... 72  
 profiles ..... 119  
 Cards ..... 72  
 Cascade ..... 13, 71  
 CC ..... 156  
 Certificate error ..... 489  
 Channels. *See* Sources.  
 Chrome, certificate error ..... 491  
 Clear duration ..... 154  
 Client PC ..... 460  
 Clocks  
 about ..... 219  
 configuration ..... 285  
 logo ..... 288  
 Closed captions  
 calibration ..... 143  
 configuration ..... 248  
 holding time ..... 145  
 standards ..... 156  
 switching on/off ..... 47  
 text mode ..... 45  
 Cluster  
 about ..... 12, 71  
 configuration ..... 88  
 rooms ..... 200  
 Color levels, in logical source ..... 188  
 Color saturation ..... 126  
 Composite monitors  
 about ..... 217  
 configuration ..... 289  
 creating ..... 289  
 resizing ..... 294  
 unlocking ..... 295  
 Configuring  
 alarm thresholds ..... 159  
 aspect ratio ..... 244  
 Audio Bridge Terminal ..... 469  
 audio scales ..... 256–257  
 client PC ..... 460  
 IP address ..... 456  
 IP settings ..... 456  
 Kaleido-RCP2 ..... 466  
 Kaleido-X ..... 94, 456, 459  
 networking ..... 460  
 RCP-200 ..... 462  
 router output signal reclocking ..... 149  
 routers ..... 325  
 serial devices ..... 387  
 static UMD text ..... 267  
 system ..... 94, 459  
 UMD text ..... 267  
 Contact Grass Valley ..... 529  
 Content advisory descriptor. *See* Metadata monitors.

Control panel	
Kaleido-RCP2	441
RCP-200	441
Corporate head office, contact	529
Countdown timers	261, 264
Cropping	
about	220
configuration	242
custom	220
operation	43
Crosspoints	54, 56–57
Customer support	529

## D

Dashboard	
disabling	210
showing on wall	37
Database	
about	71
backup	83
location	84
recommended workflow	116
retrieving backup	84
Debouncing	
about	154
configuration	162
Default layouts	19
Detail enhancement	142
Diagonal size	211
Dialnorm	136, 157
Digital content advisory descriptor	31, 282
Display libraries	
about	195
closing	215
managing	214
opening	216
Displays	
adding to room	198
aspect ratio	211
dashboard	210
diagonal size	211
full screen zone	201
height	211
position	213
properties	203
resolution	29, 204, 206, 208
rotation	212
width	212

Dolby E metadata	157
Dolby VANC	
dialnorm	136
loudness	136
DTVCC	145
Dual system	6
DVB subtitling	31, 48, 218, 277
DVI	234
DVI keying	128
DVTCC	156
Dynamic range	142

## E

EDID	29
Encoda	387
Expansion system	6, 69
Extended Data Services. <i>See</i> Metadata monitors.	

## F

Factory defaults	111
Firefox untrusted connection warning	489
Floating actions	304
Frame	
options	471
status information	441, 515
version information	441, 517
Full screen layouts	
assigning to RCP user	318
creating	227
Full screen zones	41, 201
about	195

## G

General status managers. <i>See</i> GSM.	
Global alarms	155
GPI	61, 150
GPI-1501	381
Graphical layout elements	217
Grass Valley, contact	529
GSM	
about	151
alarm browser	152
sources, from external provider	187

**H**

HD closed captions .....	156
HD-SDI monitoring output	
format .....	209
phase locking .....	210
Head office, contact .....	529
Height .....	211
HLS streams .....	105

**I**

Incremental copy	
about .....	177
using .....	189
Input method .....	50
Internal router .....	327
Internet Explorer	
certificate error .....	491
compatibility view .....	498
IP settings .....	456

**K**

Kahuna .....	398
Kaleido-IP	
about .....	10, 70
cascade .....	13, 71
layout touring .....	452
multicast join and leave .....	452
network considerations .....	452
restart .....	503
shut down .....	503
streams, ASM .....	101
streams, HLS .....	105
streams, importing from spreadsheet .....	95
streams, modifying .....	106
streams, preparing spreadsheet .....	96
streams, removing .....	108
streams, SSM/SFM .....	99
streams, unicast .....	103
Kaleido-Modular	
about .....	9
KMV-3901/3911 .....	70
network considerations .....	451
Kaleido-Modular-X, about .....	12, 69
Kaleido-MX, about .....	11, 69

Kaleido-RCP2	
about .....	311, 441
adding users .....	312
audio monitoring .....	63
configuration .....	466
layout presets .....	40
login .....	33–34, 468–469
removing users .....	312–313
user preferences .....	316

**Kaleido-X**

14 RU frame .....	6
4 RU frame .....	4
7 RU frame .....	5
about .....	69
cascade .....	13, 71
cluster system .....	71
configuration .....	94, 456, 459
expansion system .....	6, 69
frame status .....	515
internal router .....	327
network considerations .....	451
version information .....	517

**Kaleido-X16**

about .....	7, 69
cascade .....	13, 71
internal router .....	327
network considerations .....	451

**Kaleido-XQUAD, about**

about .....	10, 70
-------------	--------

**Kalypso**

about .....	387, 389
-------------	----------

**Kayak**

about .....	404
-------------	-----

**Kayenne**

about .....	411
-------------	-----

**Keyboard input method**

about .....	50
-------------	----

**Keying mode**

about .....	128
-------------	-----

**KMV-3901/3911**

about .....	70
-------------	----

**cascade**

about .....	13, 71
-------------	--------

**network considerations**

about .....	451
-------------	-----

**KX Router logical router**

about .....	326
-------------	-----

**L****Languages, input method**

about .....	50
-------------	----

**Layouts**

about .....	217
-------------	-----

**assigning to RCP users**

about .....	317
-------------	-----

**automatically populated grid**

about .....	230
-------------	-----

**background image**

about .....	233
-------------	-----

**background keying**

about .....	128
-------------	-----

**clocks**

about .....	285
-------------	-----

Layouts ( <i>continued</i> )	
closing	226
countdown timers	264
digital content advisory descriptor	282
duplicating	231
DVI background input	234
foreground keying	128
full screen	227
loading	19, 39
management	223
Metadata monitor	218
monitors, adding	229
opening	223
pan view, in XEdit	236
presets	40
refreshing	41
room layout	226
source assignment	232
subtitling monitor	277
timers	264
V-chip monitor	283
XDS metadata	31, 282
zoom, in XEdit	236
Levels	
GlobalAlarm	155
in logical source	182
in router	326, 363–364, 368
Libraries	
displays	214
layout elements	219
Loading layouts	39
Logical sources. <i>See</i> Sources.	
Login, monitor wall	33–34
Lookup services	153
Loudness	
calibration (audio program)	133
calibration (legacy)	136
microphone	159
Loudness monitors, about	218
LTC over IP	259
<b>M</b>	
Markers, safe area	44
Matrix ID	326, 363
Metadata	
AC-3	157
closed captions	156
display	31, 218, 282
Metadata ( <i>continued</i> )	
Dolby E	157
holding time	145
subtitles	156
teletext	156
Metadata monitors	
about	31, 218
configuration	282
Microphone loudness measurement	159
Monitor wall	
about	29
dashboard	37
destinations	51, 54, 232
disabling dashboard	210
loading layouts	19
login	33–34
menu font size	315
mouse pointer, locating	36
mouse pointer, large	315
restarting	503
timers	57
Monitors	
about	217
alarm	156, 218, 274
audio	218
clock	219, 285
composite	217, 289, 294
duplicating	230
loudness	218
Metadata	218
monitor wall destination	232
replication	230
resizing	294
source assignment	51, 232
subtitling	31, 218, 277
time code	218, 259
timer	218, 264
UMD	218
V-chip	31, 219, 283
video	217, 236
widget libraries	219
XDS metadata	31, 282
Mouse	
large pointer	315
locating on monitor wall	36
RCP-200	36
Multicast transport stream	
any source	101
source filtered	99
specific source	99

- Multiviewer
- cascade ..... 13
  - cluster ..... 12
  - expansion system ..... 69
  - Kaleido-IP ..... 10, 70
  - Kaleido-Modular ..... 70
  - Kaleido-Modular-X ..... 12
  - Kaleido-MX ..... 11
  - Kaleido-X (14RU) ..... 6, 69
  - Kaleido-X (4RU) ..... 4, 69
  - Kaleido-X (7RU) ..... 5, 69
  - Kaleido-X16 ..... 7, 69
  - Kaleido-XQUAD ..... 70
  - KMV-3901/3911 ..... 9
  - options ..... 471
  - status information ..... 441, 515
  - version information ..... 441
- N**
- Network impact ..... 451
  - Networking ..... 460
  - Nominal level ..... 139–140
  - NV9000 router control system
    - importing configurations ..... 338
    - profile ..... 327
- O**
- OP-47 ..... 156
  - Options ..... 443, 471
  - Overscan
    - about ..... 220
    - configuration ..... 242
- P**
- Panning ..... 236
  - Passthrough ..... 167
  - PC configuration ..... 460
  - Peripheral devices ..... 72, 387
  - Phase locking ..... 210
  - Port usage
    - client PC to multiviewer ..... 452
    - e-mail alerts ..... 454
    - iControl to multiviewer ..... 454
    - multiviewer to client PC or laptop ..... 453
  - Port usage (*continued*)
    - multiviewer to multiviewer ..... 453
    - multiviewer to/from NTP server ..... 456
    - multiviewer to/from RCP ..... 454
    - multiviewer to/from SNMP devices ..... 455
    - router controller to multiviewer ..... 455
  - Preferences, RCP user ..... 316
  - Presets ..... 40
  - Processing delay ..... 210
  - Production switchers ..... 375
    - Kahuna ..... 398
    - Kalypso ..... 389
    - Kayak ..... 404
    - Kayenne ..... 411
    - Ross Video ..... 389
    - Snell & Wilcox ..... 398
    - Sony ..... 394
    - Zodiak ..... 427
  - Profiles
    - audio calibration ..... 119
    - NV9000 ..... 327
    - video calibration ..... 119
  - Program config ..... 157
  - Programs, audio ..... 122
- R**
- RCP2. *See* Kaleido-RCP2.
  - RCP-200
    - about ..... 441
    - audio monitoring ..... 63
    - category/index panel ..... 51
    - configuration ..... 462
    - login ..... 33
    - mouse ..... 36
  - RDD 8 ..... 156
  - Reclocking ..... 149
  - Reference levels ..... 139–140
  - Refreshing layouts ..... 41
  - Region editor ..... 295–296
  - Remote control panel
    - Kaleido-RCP2 ..... 441
    - RCP-200 ..... 441
  - Resolutions
    - automatic detection ..... 29
    - backup ..... 83
    - changing ..... 208
    - custom, creating ..... 204, 206



Restoring		Safe area ( <i>continued</i> )	
database backup	84	markers, toggling	44
factory defaults	111	SCTE 27 subtitling	31, 48, 218, 277
Rooms		Serial devices	387
about	195	Serial port test third-party device	434
assigning layouts to RCP users	317	Serial to TCP/IP Dispatcher	387
closing	198	Servicing	514
cluster	200	Set duration	154
creating	196	SFM transport streams	99
dashboard	210	Signal Path Viewer, Installation	473
deleting	198	Slots, virtual	72
display aspect ratio	211	Snapshot	441
display diagonal size	211	Snell & Wilcox production switcher. <i>See</i> Kahuna.	
display height	211	SNMP traps	173
display position	213	Sony production switchers	394
display properties	203	Source-filtered multicast transport streams	99
display resolution	204, 206, 208	Sources	
display rotation	212	about	71, 177
display width	212	alarm levels	186
displays	198	assigning to monitors	51, 232
full screen layouts	227	color levels	188
full screen zone	201	configuration	178
layouts	226	EXT	187
mouse pointer	315	external providers	187
opening	196	full screen	41
pan view, in XEdit	236	levels	182
zoom view, in XEdit	236	template	185
Ross Video production switchers	389	Sources table	
Rotation	212	filtering	191
Router Control, installation	473	resizing columns	192
Router controllers	325	sorting	190
Routers		SSM transport streams	99
cards, SDI signal reclocking	149	Status	
configuration	325	alarm	152
crosspoints	54, 56–57	information	441
field selection switching	148	system	13
importing from NV9000	338	Subtitling	
internal	327	calibration	143
KX Router	326	configuration	248
levels	363–364, 368	holding time	145
logical levels	326	standards	156
matrix ID	326, 363	text mode	45
physical levels	326	Subtitling monitors	
		about	31, 218
		aspect ratio	281
		configuration	277
		Support, contact	529
		Switchers. <i>See</i> Production switchers.	
		System	
		about	69
<b>S</b>			
Safe area			
free-form	239		
markers	239		

- System (*continued*)
- backup ..... 83
  - cascade ..... 13, 71
  - cluster ..... 12, 71, 88
  - configuration ..... 94
  - creation ..... 84
  - dual ..... 6
  - expansion ..... 6, 69
  - Kaleido-IP ..... 10, 70
  - Kaleido-Modular ..... 70
  - Kaleido-X (14RU) ..... 6, 69
  - Kaleido-X (4RU) ..... 4, 69
  - Kaleido-X (7RU) ..... 5, 69
  - Kaleido-X16 ..... 7, 69
  - Kaleido-XQUAD ..... 70
  - KMV-3901/3911 ..... 9
  - options ..... 471
  - phase locking ..... 210
  - retrieving backup ..... 84
  - snapshot ..... 514
  - status information ..... 515
  - verification ..... 13
  - version information ..... 517
- T**
- Tally interface devices ..... 375
  - Technical support ..... 529
  - Teletext ..... 156
  - Template ..... 185
  - Text mode ..... 45, 248
  - Third-party devices
    - serial port test ..... 434
    - TSL (serial) ..... 387
  - Time code monitors
    - about ..... 218
    - configuration ..... 259
  - Timers
    - about ..... 218
    - assigning to RCP users ..... 320
    - assigning to rooms ..... 316
    - configuration ..... 261
    - monitor ..... 264
    - operation ..... 57
  - Transport streams
    - ASM ..... 101
    - HLS ..... 105
    - SFM ..... 99
    - SSM ..... 99
  - Transport streams (*continued*)
    - unicast ..... 103
  - Traps, SNMP ..... 173
  - Troubleshooting, system snapshot ..... 441, 514
  - TSL ..... 387
- U**
- UMD
    - about ..... 218
    - editing text ..... 50
    - static text ..... 267
    - text font ..... 267
  - Under monitor displays. *See* UMD.
  - Underscan
    - about ..... 220
    - configuration ..... 242
  - Untrusted connection warning ..... 489
  - Upgrading ..... 518
- V**
- V-chip monitors
    - about ..... 31, 219
    - configuration ..... 283
  - Version information ..... 441, 517
  - Video monitors
    - about ..... 217
    - aspect ratio ..... 238
    - configuration ..... 236
    - cropping ..... 242
    - full screen ..... 41
    - overscan ..... 43, 242
    - resizing ..... 238
    - safe area ..... 44, 239
    - underscan ..... 43, 242
    - zooming ..... 242
  - Virtual card slots ..... 72
  - VLAN ..... 508–509
- W**
- Widget libraries
    - about ..... 219
    - configuration ..... 298
  - Widgets. *See* Monitors.
  - Width, display ..... 212

Workflow, database management .....	116
WSS	
about .....	219
configuration .....	244
WST .....	156

## X

XAdmin	
about .....	441
access control .....	499
options .....	443
virtual card slots .....	72
XDS. See Metadata monitors.	
XEdit	
about .....	71, 441
access control .....	78
installation .....	473
opening .....	73
password .....	77
shortcuts .....	7
virtual card slots .....	72

## Z

Zero VU .....	139–140
analog .....	121
digital .....	121
Zodiak .....	427
Zooming	
configuration .....	242
layout, in XEdit .....	236
operation .....	43





## **Grass Valley Technical Support**

For technical assistance, contact our international support center, at 1-800-547-8949 (US and Canada) or +1 514 333 1772.

To obtain a local phone number for the support center nearest you, please consult the Product Support section of Grass Valley's Web site, at <http://www.grassvalley.com/support/contact>.

An online form for e-mail contact is also available from the Web site.

## **Corporate Head Office**

Grass Valley  
3499 Douglas-B.-Floreani  
St-Laurent, Quebec H4S 2C6  
Canada  
Telephone: +1 514 333 1772  
Fax: +1 514 333 9828  
[www.grassvalley.com](http://www.grassvalley.com)