

iCLOCK

iCLOCK_{dp}

REDUNDANT MULTIPLE CLOCK SYNTHESIZER AND VIDEO REFERENCE GENERATOR **VERSION 2.22**

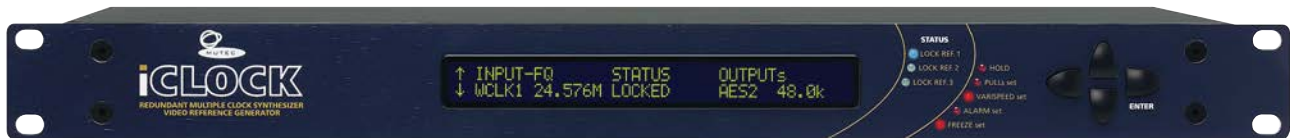

HD TV DSD DXD
Direct Stream Digital Digital eXtreme Definition



SAFETY INSTRUCTIONS

General instructions

To reduce the risk of fire or electrical shock, do not expose this appliance to rain or moisture, direct sunlight or excessive heat from sources such as radiators or spotlights. No user serviceable parts are inside. Repair and maintenance must be carried out by qualified personnel authorized by MUTECH GmbH! The unit has been designed for operation in a standard domestic environment. Do NOT expose the unit and its accessories to rain, moisture, direct sunlight or excessive heat produced by such heat sources as radiators or spotlights! The free flow of air inside and around the unit must always be ensured.



Initial operation

Prior to the initial operation of the unit, the appliance, its accessories and packaging must be inspected for any signs of physical damage that may have occurred during transit. If the unit has been damaged mechanically or if liquids have been spilled inside the enclosure, the appliance may not be connected to the mains or must be disconnected from the mains immediately! If the unit is damaged, please do NOT return it to MUTECH GmbH, but notify your dealer and the shipping company immediately, otherwise claims for damage or replacement may not be granted.

If the device is left in a low-temperature environment for a long time and then is moved to a room-temperature environment, condensation may occur on the inside and the exterior. To avoid short-circuits and flashovers, be sure to wait one or two hours before putting the device into operation.

Power supply

The device contains a self-adapting wide-range power supply supporting the majority of global standard line voltages within a range of 90...250 V, with no need for making adjustments. Make sure that your line-voltage source provides a supply voltage within the specified range. In addition, make sure that the device is properly grounded via the local electric installation.

Please use the enclosed power cord (see packaging) to connect the unit to the mains. Switch the unit off before you attempt to connect it to the mains. Connect the power cord to the unit, then to a standard 3-pin mains outlet. To draw the power cord, never pull on the cable but on the mains plug!

The unit must be grounded during operation!

For information on the power-inlet wiring, refer to the »Wiring of connectors« section in the appendix. Disconnect the device from the mains when not using it for an extended period!



This symbol, a flash of lightning inside a triangle, alerts you to the presence of uninsulated dangerous voltage inside the enclosure - voltage that may be sufficient to constitute a risk of shock.



This symbol, an exclamation mark inside a triangle, alerts you to important operating or safety instructions in this manual.

Declaration of Conformity

We herewith confirm that the product complies with the European Commission's standards on electromagnetic compatibility.

Interference emission: EN 55103-1:1996
Resistance to interference: EN 55103-2:1996

Presupposed as operation condition is that all clock outputs are connected with high-quality and good shielded BNC 75 ohms cable.



WARRANTY REGULATIONS

§1 Warranty

MUTECH GmbH warrants the flawless performance of this product to the original buyer for a period of two (2) years from the date of purchase. If any failure occurs within the specified warranty period that is caused by defects in material and/or workmanship, MUTECH GmbH shall either repair or replace the product free of charge within 90 days. The purchaser is not entitled to claim an inspection of the device free of charge during the warranty period. If the warranty claim proves to be justified, the product will be returned freight prepaid by MUTECH GmbH within Germany. Outside Germany, the product will be returned with the additional international freight charges payable by the customer. Warranty claims other than those indicated above are expressly excluded.

§2 Warranty transferability

This warranty is extended exclusively to the original buyer who bought the product from a MUTECH GmbH specialized dealer or distributor, and is not transferable to anyone who may subsequently purchase this product. No other person (retail dealer, distributor, etc.) shall be entitled to give any warranty promise on behalf of MUTECH GmbH.

§3 Warranty regulations

The return of the completed registration card, or online registration on one of the websites specified below, is a condition of warranty. Failing to register the device before returning it for repair will void the extended warranty.

- The serial number on the returned device must match the one stated on the registration card or entered during online registration. Otherwise, the device will be returned to the sender at the sender's expense.
- Any returned device must be accompanied by a detailed error description and a copy of the original sales receipt issued by a MUTECH dealer or distributor.
- The device must be returned free of shipping expenses and in the original package, if possible; otherwise, the sender has to provide comparably protective packaging.
- The sender is fully responsible for any damage or loss of the product when shipping it to MUTECH GmbH.

§4 Limitation of warranty

Damages caused by the following conditions are not covered by this warranty:

- Damages caused by every kind of normal wear and tear (e.g. displays, LEDs, potentiometers, faders, switches, buttons, connecting elements, printed labels, cover glasses, cover prints, and similar parts).
- Functional failure of the product caused by improper installation (please observe CMOS components handling instructions!), neglect or misuse of the product, e.g. failure to operate the unit in compliance with the instructions given in the user or service manuals.
- Damage caused by any form of external mechanical impact or modification.
- Damage caused by the user's failure to connect and operate the unit in compliance with local safety regulations.
- Damage caused by force majeure (fire, explosion, flood, lightning, war, vandalism, etc.).
- Any consequential damages or defects in products from other manufacturers and any arising costs from impairment or loss of productions or any other forms of events.

Repairs carried out by personnel which is not authorized from MUTECH GmbH will void the warranty. Adaptations and modifications to the device made with regard to national, technical, or safety regulations in a country or of the customer do not constitute a warranty claim and must be set with MUTECH GmbH in advance.

§5 Repairs

To obtain warranty service, the buyer must call or write to MUTECH GmbH before returning the unit. All inquiries must be accompanied by a description of the problem and the original buyer's invoice. Devices shipped to MUTECH GmbH for repair without prior notice will be returned to the sender at the sender's expense. In case of a functional failure please contact:

MUTECH Gesellschaft fuer Systementwicklung und Komponentenvertrieb mbH

Siekeweg 6/8 • 12309 Berlin • Germany • Fon 030-746880-0 • Fax 030-746880-99 • Tecsupport@MUTECH-net.com • www.MUTECH-net.com

MUTECH GMBH ASSUMES NO LIABILITY FOR ANY INCORRECT INFORMATION GIVEN IN THIS MANUAL. PLEASE NOTE THAT ALL SOFTWARE/HARDWARE PRODUCT NAMES ARE REGISTERED TRADEMARKS OF THEIR RESPECTIVE OWNERS. NO PART OF THIS MANUAL MAY BE REPRODUCED, COPIED OR CONVERTED TO A MACHINE-READABLE FORM OR ELECTRONICAL MEDIA WITHOUT A WRITTEN PERMISSION OF MUTECH GMBH. WE RESERVE THE RIGHT TO CHANGE OR IMPROVE OUR PRODUCTS WITHOUT NOTICE. © MUTECH GMBH 2004-2013

CONTENTS

INTRODUCTION

About this Manual	7
General Function Description	7
Differences between Software V2.10 and V2.11.	8
Features	8
Applications.	8
Optional Products	8

CONTROL ELEMENTS

iCLOCK Front Panel.	9
iCLOCK + iCLOCKdp Rear Panels	9

INSTALLATION

Content of the Box	11
Placing the Device	11
Wiring the Word Clock and Video Interfaces	11
Wiring the AES/EBU and S/PDIF Interfaces	12

GENERAL OPERATION

Menu Structure	13
Selecting Menu Pages and setting Functions	14

MENUS AND FUNCTIONS

Main Menu Page	14
Selecting and activating Clock Sources	16
Configuring the internal Video Reference Generator	18
Configuring the Word Clock Outputs	20
Configuring the AES/EBU Outputs	21
Configuring the S/PDIF Outputs	23
Setting System Functions (Pull Up/Pull Down, Varispeed, etc.)	25
Preset Management	29

iCLOCK TECHNOLOGY

Functional Principle.	33
SoftReLock	33
Sequence Synchronization.	34
Cycle Synchronization	34

iCLOCK EXTENSIONS

iC-ALARM up to V2.10	35
iC-ALARM/GPI from V2.11 or higher	36
General Function Description	36
Features	36

APPENDIX

Synchronizable HD tri-level Standards and Frame Rates.	37
Synchronizable and generatable Clock Rates.	37
Pin Assignment of the Connectors	38
Connecting the universal Clock Inputs to Ground	39
Switching-off the Termination of the universal Clock Inputs	39
Splitting-up the Video Outputs for dual Video Generator Operation	39
Technical Data	40



INTRODUCTION

Thank you very much for purchasing iCLOCK or iCLOCKdp, Redundant Multiple Clock Synthesizer & Video Reference Generator, from MUTECH!

About this Manual

The whole manual is related to both versions in general, iCLOCK and iCLOCKdp. The individual differences are mentioned in the according sections and chapters.

The structure of this manual refers to the normal process of installing iCLOCK in a standard audio/video studio environment. Thus the chapters are ergonomically sorted to provide a fast set-up. Before first power-on we recommend to read the chapters INTRODUCTION and BRIEF INSTRUCTIONS to get to know the general functionality of iCLOCK and to reach a fast system integration.

The following chapters OPERATION and iCLOCK TECHNOLOGY describe individual functions which enable the adaption of iCLOCK to every studio environment. The chapters APPLICATION EXAMPLE and APPENDIX include descriptions of favorable studio set-ups as well as all technical information.

If there are any uncertainties when operating the units which can not be cleared up by the content of this manual, please feel free to contact your local dealer or MUTECH directly. All contact details are included in chapter WARRANTY REGULATIONS located at the beginning of the manual.

General Function Description

iCLOCK is a synchronizable, high-precision clock generator which is designed to be the reference in digital audio and video studios as well as broadcast and television stations. Based on a totally new concept of frequency generation, developed by MUTECH, the unit offers an unchallenged flexibility for synchronization of different devices to one house clock. On this occasion iCLOCK breaks traditional, unflexible forms of chaining input and output signals and allows for the first time their completely free combination and scaleability.

iCLOCK's philosophy is addressed to provide the highest possible failure safety for all outgoing clock signals which is needed especially for broadcast stations or centralized clock distribution systems. With regards to this functionality up to 3 independent external references can be auto-detected and locked in a user-defined sequence without any phase-jumps or interruptions in the outgoing signals. This applies also to external clock frequency changes, e.g. from 44.1kHz to 48.0kHz or reference clock changes, e.g. from video to GPS or AES11. Even if all external references are lost, iCLOCK synthesizes the outgoing clock signals based on the last incoming frequency constantly. If the absent reference clock returns the synthesizer will lock gradually again based on iCLOCK's SoftReLock functionality which ensures interruption-free adjustments of all outgoing clock signals. In this case a continuous clock supply for all connected devices is guaranteed during any operation mode.

For today's audio/video productions a precision synchronization of the used audio and video equipment is imperative. To reach the highest value of accuracy the involved clock signals need to be synchronized and converted without any phase drift. Therefore iCLOCK offers a unique, automatically working signal management which observes the phase relationships of all input and output signals and takes care of adjustments aligned to AES11-1997/2003 and EBU R83-1996.

Using DDS-coupled frequency generation and latest DSP-based filtering technologies in combination with an extremely low-jitter clock basis of < 10ps (RMS), iCLOCK eliminates the jitter of incoming reference signals completely. This ensures highest possible jitter attenuation for all outgoing clock signals. As a result the synchronization of connected devices is much more reliable and the sound quality of every AD/DA converter will be increased significantly.

The grey boxes contain supplementary information for the corresponding sections in the text columns. The content of the individual box refers to the description in the text column beside the box.



 Boxes which contain a triangle with an exclamation mark should be read carefully! These include additional information which are of major importance for the functional descriptions in the text column.

Synchronizable references

- HD tri-level syncs
- SD bi-level syncs
- Word Clock + Word Clockx256 (so called Super Clock for ProTools™ systems)
- DSD 64, DSD 128 + DXD
- AES3 + AES11
- AES3 id + AES11 id
- S/P-DIF
- GPS
- Telecom
- DCF77
- MSF60
- Internal SD video reference generator
- Further references through option cards or custom designed-programming

Generatable references

- SD bi-level as Black & Burst or composite sync
- Word Clock + Word Clockx256 (so called Super Clock for ProTools™ systems)
- DSD64, DSD128 + DXD
- Film and video frame + field rates
- AES11
- S/P-DIF
- GPS
- Further clock signals through option cards

  
Direct Stream Digital Digital eXtreme Definition

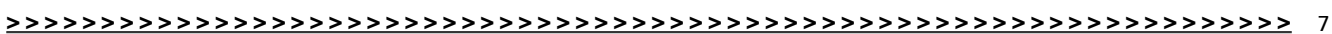

Differences between Software V2.10 and V2.11

Both versions include the preset management as new functionality, which was inquired by several professional MUTEK customers (see page 28). Using software V2.10 or V2.11 depends on the alarm interface you have already installed or you plan to install. Software V2.10 supports only the older interface iC-ALARM (ordering no. 8005-056), whereas software V2.11 supports only the new iC-ALARM/GPI (ordering no. 8005-066).

The iC-ALARM/GPI interface offers same basis functionality like the iC-ALARM, but the new iC-ALARM/GPI interface allows for switching over the different presets via its GPIO function (see page 31, 32).

Features

- Synchronizable digital audio clock synthesizer with integrated SD bi-level (PAL/NTSC) + Word Clock + AES11 + S/PDIF sync generators.
- Locks nearly 20 different HD tri-level standards and frame rates
- Converts HD tri-level syncs into SD bi-level syncs
- High-accurate reference generation with an accuracy of <0.1ppm.
- Lowest jitter clock base with <10ps (RMS).
- Redundant (fail-safe) operation.
- DDS-based jitter elimination of incoming reference signals.
- Synchronizable SD bi-level, AES11 and S/PDIF generators.
- Synchronization and generation of 36 Word Clock rates.
- Generation of different PAL and NTSC pilot tones.
- Synchronization and generation of all AES3/-11 and S/PDIF clock rates up to 192.0kHz.
- DSD64, DSD128 + DXD clock rates standardly supported.
- High-accurate GPS or Atomic Clock references, like 10.0MHz and others, are synchronizable, distributable and generatable.
- No limitation of input assignment at the universal inputs.
- SoftReLock functionality for recurring reference signals.
- CYCLESYNC functionality for automatically re-synchronization.
- Drop out compensation of incoming reference signals.
- Generation of multiple clock rates at the same time.
- Free scalability of all output clock signals.
- Automatic signal management aligned to AES11 and EBU R83.
- Digital varispeed up to ±20%.
- Supports all pull up/pull down rates for film, audio and video transfers.
- Follows external references up to ±20% (reducible).
- Programming of additional clock rates between 1.0Hz–25.0MHz.
- Programming of additional lock ranges between 1.0kHz–30.0MHz.
- Easy and convenient operation through large display.
- Soft and hardware upgradeability and recalibratability.

Applications

- Audio and HD/SD video synchronization
- Jitter attenuation in clock signals
- Centralized + redundant A/V clock distribution
- Conversion between HD tri-level syncs, SD bi-level syncs, Word Clock, DSD, DXD, AES3/-11, AES3-/11id, S/PDIF, GPS, Telecom, DCF77, MFS60 and optional standards
- Synchronization, distribution and generation of high-accurate GPS or Atomic Clock references
- Failure securing in clock distribution systems
- Film, video and audio transfers
- Synchronization of pilot tone resolvers, timecode generators, film projectors
- Coupling of HD/SD based multi-format video systems

Optional Products

- iCLOCK dp iCLOCK basis unit with two redundant power supplies
- P/NVSG-02 Second, synchronizable SD bi-level video sync generator
- iC-ALARM Relais-coupled alarm signal interface
- iC-ALARM/GPI Relais-coupled alarm signal and GPIO interface
- iC-WCO-4 4 x Word Clock output expansion
- iC-PROG Programming of additional clock rates and lock ranges
- iC-CAL0.1 Re-calibration of internal reference oscillator to <0.1ppm



CONTROL ELEMENTS

iCLOCK + iCLOCKdp Front Panel



iCLOCK and iCLOCKdp front panels look equal

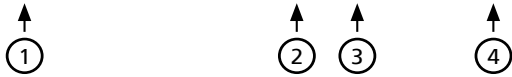

1 DISPLAY

All parameter and function settings are controlled using the display and the four cursor buttons.

2+3 STATUS Indicators

The three blue indicators show the lock status of the currently active clock source. The five red indicators show important system statuses of iCLOCK.

4 CURSOR Buttons

All parameter and function settings are controlled using the four cursor buttons and the display.

Refer to the OPERATIONS chapter for more information.

iCLOCK Rear Panel

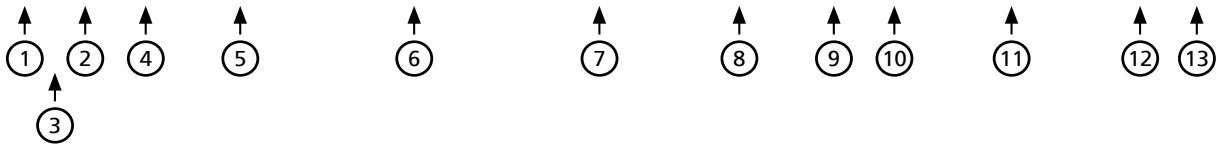

iCLOCKdp Rear Panel



1+2 INPUT1, INPUT2

These universal input terminals allow for applying various external clock signals for synchronizing the internal clock synthesizer. All clock formats supported by the system can be received at any of these inputs. These two inputs and INPUT 3 can be synchronized by the synthesizer in a freely configurable sequence. The impedance of each input is 75Ω and can be switched off internally for chaining devices, see the »Switching-off the Termination of the universal Clock Inputs« section in the appendix.

3 ALARM OUT

The iC-ALARM output is optionally available (item no. 8005-065). Refer to the EXTENSIONS chapter for a short overview.

4 INPUT3 (AES/EBU)

A balanced digital AES/EBU signal can be applied to this input for synchronizing the internal clock synthesizer. The signal must comply with AES3–1992 (R1997) or AES11–1997.

Both input terminals are isolated from ground to avoid interference from the connected clock line. This applies to all clock references except video! Is a video signal selected as reference the corresponding input will be connected to ground automatically.

If this does not comply with the electrical studio purposes, the ground connections of both inputs could be linked permanently by setting jumpers on the mainboard. Refer to the »Connecting the universal Clock Inputs to Ground« section in the appendix for a short instruction.



INSTALLATION

Content of the Box

The unit was packed carefully. Nevertheless we recommend to check the content directly after opening the package:

- 1 x iCLOCK/iCLOCK dp
- 1 x Power cable, 2 x power cables for iCLOCK dp
- 4 x Rubber feet
- 1 x Manual
- 1 x Registration card

Placing the Device

The unit should be set up as closely as possible to the devices to which it will be connected, so as to avoid excessive cable lengths. Use the 4 rubber feets enclosed with the appliance and stick them symmetrically on the bottom side of the unit to protect the enclosure and supporting surface from being damaged.

The device can be mounted into a standard 19" rack and will require 1 unit. In this case, the rubber feet cannot be attached. Install the device so that one unit of rack space is left free both above and below the device to allow for sufficient ventilation! The mounting depth including the terminals is 240 mm/9.45" for iCLOCK and 280mm/11.02 for iCLOCK dp. Another 60 mm/2.4" should be added for the required cables.

Additional slide-in rails on the rack inside are recommended for safe installation. This will also avoid long-term mechanical deformation of the housing.

Wiring the Word Clock and Video Interfaces

To allow for synchronization of signals, the interfaces of all devices involved must be properly connected to each other, so as to ensure a logical signal flow. Always be sure to connect the Word Clock outputs of iCLOCK to the according inputs of the devices you wish to synchronize! Cable lengths should be kept as short as possible to minimize signal losses and/or interference!

For the transmission of Word Clock or video signals electrical, asymmetrical cables with a resistance of 75Ω and BNC connectors on both ends are used. Typically, such cables are marked »RG-59U, RG59B/U«.

Additionally, you should make sure that the Word Clock or video inputs to be connected to iCLOCK's outputs have a 75Ω terminating resistor! Most Word Clock or video inputs allow for enabling/disabling the termination with a so-called »termination-switch«, which may be located on the outside or inside of the device.

For devices which have no termination of the Word Clock input, e.g. RME Hammerfall with Word Clock i/o or Alesis BRC, you can use an additional BNC-T piece to terminate the input. Plug the T piece with its center connector into the input of the receiving device. Then, connect the cable coming from iCLOCK to one of the lateral connectors, and the other connector of the BNC-T piece to a 75Ω resistor forming the BNC termination.

Basically, you should avoid »looping through« Word Clock leads by means of passive BNC-T pieces to preserve the signal quality, as level drops will be the result. If there is no other way to wire your set-up, please make sure that all Word Clock inputs (except for the last device in the chain) have their terminations disabled! In a serial Word Clock chain only the last clock input should have a termination! Never connect more than three devices in series to one output!

! Before Powering Up

The condition of the packaging material and the device should be checked carefully additionally. If there are any damages please refer to SAFETY INSTRUCTIONS, Initial Operation, and WARRANTY REGULATIONS.

Before installing the unit the section SAFETY INSTRUCTIONS located at the beginning of this manual should be read carefully.

Never expose the device and accessories to rain, moisture, direct sunlight, or excessive heat produced by radiators, heaters, or spot lights! Sufficient air circulation in the environment of the device must be ensured!

! Clock Cable Lengths

It is imperative that the lengths of all cables connected are largely the same, as this is the only way to ensure that all devices will be synchronized in phase (exception: cable tolerances).

Please make sure that the cable used has a resistance of 75Ω, in compliance with the specifications! If a cable with a different resistance is used, a dramatic deterioration of the signal quality can be the result! In this case, the perfect synchronization of all devices involved could be impaired.

We recommend using high-grade cables with a good shielding for your clock signal leads, in particular, if you need to transmit Word Clockx256 (so-called Super Clock) signals over greater distances. In any case, a length of max. 10 meters (approx. 30 feet) should never be exceeded!

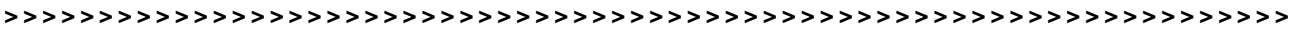

GENERAL OPERATION

Menu Structure

The entire menu structure is based on the logical flow of events when deploying the iCLOCK in a standard audio/video-studio environment. Therefore, starting with the menu main page, the menu pages have an ergonomically structured sequence and can thus be called successively by repeatedly pressing the up button.

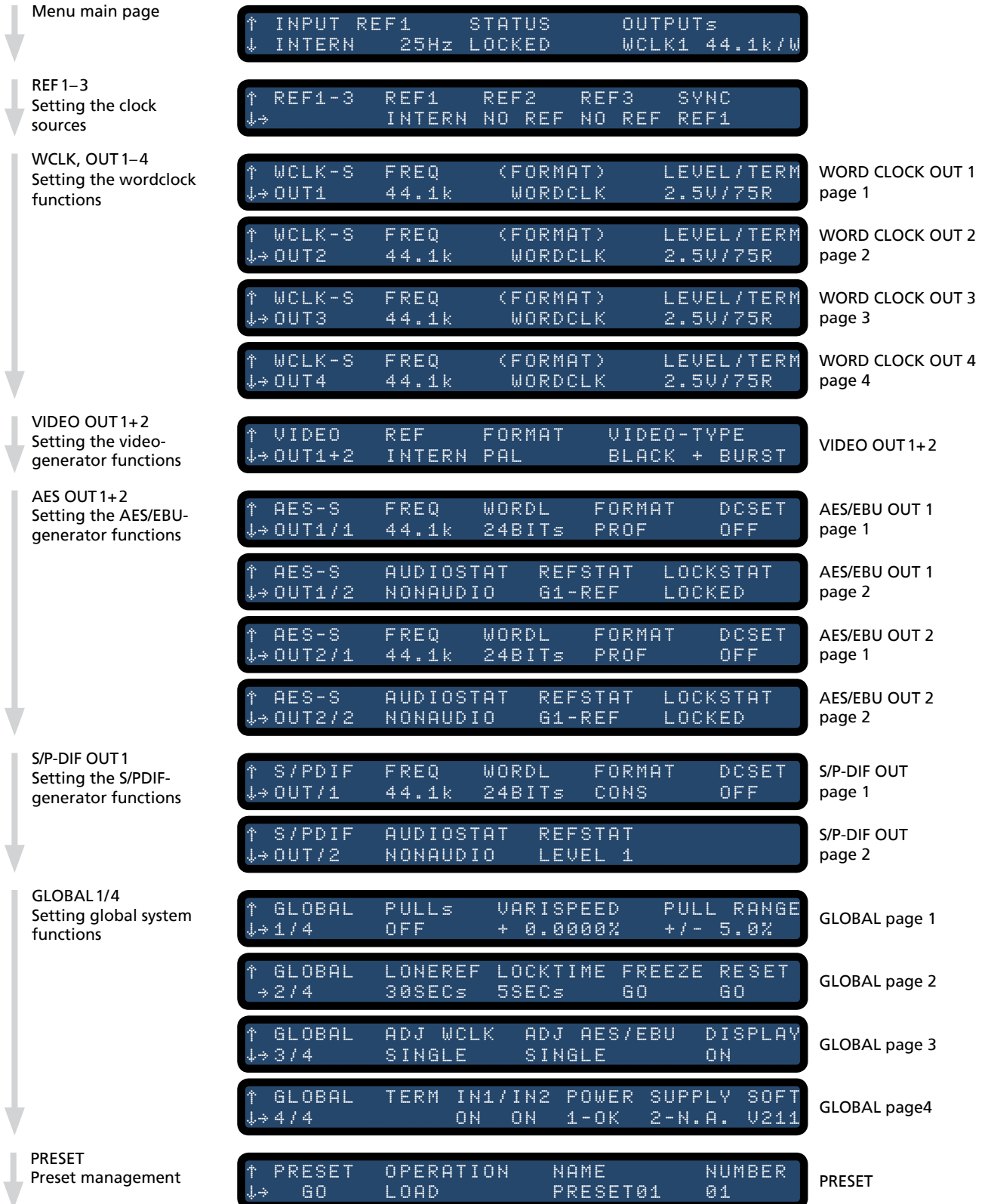

MENUS AND FUNCTIONS

Main Menu Page

When the device is switched on, a boot period of approximately seven seconds will occur. During this period, the display will show two pages in succession. The first of them provides information on the current firmware version.



Boot pages

After the boot period, the menu main page will be displayed. This page is always displayed during standard operation; in combination with the eight front panel indicators, it provides information on the basic device status.



Menu main page

INPUT REF1, -2, -3

INPUT REFERENCE, shows an abbreviation of the clock source currently selected incl. its reference slot and its actual rate as a realtime measurement. As display space is limited, the displayed value is automatically adapted with regard to the decimal places and the frequency unit as follows:

- Hz = hertz
- k = kilohertz
- M = megahertz

Refer to the »Selecting Clock Sources« section in this chapter for information on individual sources.

STATUS (function)

Shows the current system status. STATUS provides information on the device synchronization and possible system errors. Major functionalities are indicated through eight LEDs on the right hand side of the display additionally.

LOCKED (status message)

LOCKED indicates that the system has synchronized to the internal video reference generator or an externally applied clock signal. At the same time, the blue LOCK indicator associated with the active clock input (INPUT 1 - 3) will light.

FQ CHANGE (status message)

FREQUENCY CHANGE indicates that a sync source change is occurring. This can be a change between two externally applied clock signals or an automatically or manually performed change from an external to an internal clock source (or vice versa). When the change occurs, the LOCK indicator of the last clock source used will go dark, and the red HOLD indicator will light. When the system has locked to the new source, the HOLD indicator will go dark, and the associated LOCK indicator will light.

HOLD (status message)

HOLD indicates that an externally applied clock signal has either drifted outside its permitted lock range (see the PULL RANGE parameter on the GLOBAL 1/4 page) or is completely lost. In this case, the system waits for a certain period for the signal to return before automatically changing to the next clock source. This waiting period specified by the LONEREF parameter on the GLOBAL 2/4 page.

CYCLESYNC (status message)

CYCLE SYNCHRONIZATION indicates that the system is currently performing an automatic resynchronization. This function can be disabled on the REF1-3 page or be enabled manually for individual clock source inputs.



All user-specific parameter settings are available furthermore when power is restored.



Status Displays

When iCLOCK is running in INTERN mode the first blue LED, LOCK REF 1, will light and confirm the synchronization of the synthesizer to the internal video reference generator.

After first switching on, the synthesizer needs approx. 30 seconds to achieve stable synchronization. This depends on the time the video reference generator needs for attuning all components of its video output signal.

During this process the system re-locks temporarily (the HOLD LED and the blue LOCKED REF 1 LED are lightening alternately). This has no relevance for system security. The output clocks are constantly available.



This function also ensures a redundant (failsafe) availability of the video output signals. If the external source fails temporarily or permanently, the video generator will continue generating its output signals based on the last recognized clock rate. If the external source returns to operation, any differences to the previous rate will gradually be corrected to maintain flawless on-air operation in e.g. broadcasting environments.

DIST (setting)

DISTRIBUTION This setting allows for forwarding the input video signal to the video outputs using a hardware bypass. The signal is refreshed by the video generator output amplifier to ensure a suitable output level; no other modifications are made to the signal. If the DIST setting has been selected for REF, the FORMAT and VIDEO TYPE functions cannot be selected anymore. This is because the video output format is determined by the input video reference signal.

In this mode, the synthesizer synchronizes to the input video signal to provide the output of phase locked audio clock signals.

FORMAT (function)

FORMAT This function allows for selecting the video format generated and output by the video generator. The factory default is PAL.

PAL (setting)

PAL With this setting, the video generator produces a PAL-B/G standard definition (SD) video signal compliant with the PAL/CCIR video standard (25 fps, 625 lines, 15,625.0Hz line frequency). Depending on the REF and VIDEO TYPE settings, this signal can be output as Black+Burst or composite video sync. Even when a HD tri-level source is choosed as reference (HD-P-1/2), the PAL setting is possible. Thus the internal video reference generator directly converts incoming HD references with frame rates of 24Hz, 25Hz, 30Hz, 50Hz or 60Hz into PAL SD video using its unique cross-locking functionality.

NTSC (setting)

NTSC With this setting, the video generator produces an NTSC standard definition (SD) video signal (29.97 fps, 525 lines, 15,734.25Hz line frequency). Depending on the REF and VIDEO TYPE setting, this signal can be output as Black+Burst or composite video sync.

Even when a HD tri-level source is choosed as reference (HD-N-1/2), the NTSC setting is possible. Thus the internal video reference generator directly converts incoming HD references with frame rates of 23.98Hz, 29.97Hz or 59.94Hz into NTSC SD video using its unique cross-locking functionality.

Refer to the »Synchronizable HD tri-level Standards and Frame Rates« section in the APPENDIX for a list of all convertable HD standards and frame rates.

VIDEO TYPE (function)

VIDEO TYPE This function allows for outputting the previously selected video format as Black + Burst or composite video sync signal. In addition, when selecting composite video sync, one of two different output levels can be set (see below). The factory default is BLACK+BURST.

BLACK + BURST (setting)

BLACK+BURST With this setting, the signal of the previously selected format will be output as Black + Burst signal. Refer to the »Technical Data« section in the APPENDIX.

COMPOSITE SYNC 0.3V (setting)

COMPOSITE 0.3V With this setting, the previously selected video format is output as composite video sync signal with a negative sync signal level of 300mV (0.3V).

COMPOSITE SYNC 2.0V (setting)

COMPOSITE 2.0V With this setting, the previously selected video format is output as composite video sync signal with a negative sync signal level of 2.0V.



Locking the internal Video Reference Generator – 2

When running the internal video reference generator in EXTERNAL mode, the external reference signal may not deviate more than ± 30 ppm from its nominal clock frequency! Do not try to lock the video generator to pull up/down clock rates - its video signal would be destroyed!

DIST does not provide redundancy for the video outputs. If the external video reference source fails, the video outputs will fail, too!



Locking the internal Video Reference Generator – 3

When externally synchronizing the video reference generator, the lock and varispeed ranges of the synthesizer will be reduced to ± 30 ppm! Thus, enabling the pull-up/down and varispeed factors is not provided in this mode. If, however, these settings are made, the video generator will automatically enable internal synchronization.

When locking the synthesizer to the internal video reference generator or when locking the video reference generator to an external applied reference source, a synchronization time of approx. 30 seconds for attuning all components of the video output signal is required.

During this process the system re-locks temporarily (the HOLD LED and the blue LOCKED REF 1 LED are lightening alternately). This has no relevance for system security. The output clocks are constantly available.

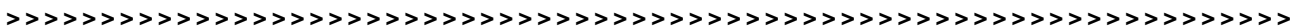



LEVEL / TERM (function)

LEVEL/TERMINATION This function allows for adjusting the Word Clock signal level of the selected output pair and for entirely disabling the output. The page always displays the output level and the corresponding internal termination of the output pair. The factory default is 2.6V/75R.

2.5V/75R (setting)

With this setting, the Word Clock signal is output with a level of 2.6V and an internal termination of 75Ω.

3.5V/22R (setting)

With this setting, the Word Clock signal is output with a level of 3.5V and an internal termination of 22Ω. This setting is recommended for Word Clock signals to be transmitted over great distances.

SC adapted (setting)

SUPER CLOCK adapted This is no adjustable setting but a status message used only for clock rates set to Super Clock. Here, the level cannot be modified but only be disabled if required (OFF).

OFF (setting)

OFF disables the selected Word Clock out pair.

Configuring the AES/EBU Outputs

The four AES/EBU outputs can be set to various clock rates by pairs. In addition, the channel-status bits can be modified individually.

```
↑ AES-S   FREQ   WORDL   FORMAT   DCSET
↓→ OUT1/1  44.1k  24BITs  PROF     OFF
```

First AES/EBU output pair, page 1

```
↑ AES-S   AUDIOSTAT REFSTAT  LOCKSTAT
↓→ OUT1/2  NONAUDIO G1-REF  LOCKED
```

First AES/EBU output pair, page 2

```
↑ AES-S   FREQ   WORDL   FORMAT   DCSET
↓→ OUT2/1  44.1k  24BITs  PROF     OFF
```

Second AES/EBU output pair, page 1

```
↑ AES-S   AUDIOSTAT REFSTAT  LOCKSTAT
↓→ OUT2/2  NONAUDIO G1-REF  LOCKED
```

Second AES/EBU output pair, page 2

AES-S, AES-L (page name)

AES-SINGLE, -LINKED The »S« and »L« letters shown on each of the two AES/EBU menu pages indicate the Single and Linked modes. Refer to the ADJ-AES/EBU parameter on the GLOBAL 3/4 page explained in the SETTING SYSTEM FUNCTIONS chapter for more information. The factory default is Single mode (-S).

OUT1/1, -1/2, -2/1, -2/2 (page name)

The page name contains the selected AES/EBU-output pair (1 or 2) and the number of the currently displayed menu page. The pages AES OUT 1/1 and AES OUT 1/2 allow for configuring the first output pair while the pages AES OUT 2/1 and AES OUT 2/2 are used for the second output pair.

Functions and settings on the first page of each AES/EBU output pair:

FREQ (function)

FREQUENCY Sets the clock rate of the selected AES/EBU output pair. A so-called AES11 clear-frame signal (compliant to AES 11-1997/2003) is generated. The factory default is 44.1kHz.

16.0...192.0kHz (setting)

Altogether twelve different clock rates between 16.0...192.0kHz can be individually selected for each AES/EBU-out pair. Refer to the »Synchronizable and Generatable Clock Rates« section in the appendix for a full list of all clock rates.

More Clock Frequencies

For special-purpose applications, the range or number of the output clock frequencies can be extended by means of a software update. Practically any frequency or frequency range between 1.0Hz and 25.0MHz can be defined and can then be selected for all Word Clock outputs, providing the same functionality as the standard frequencies.

For more information or a proposal, send an e-mail message to

tecsupport@iCLOCK-net.de

You may also call us or send a fax:

Phone 0049-(0)30-746880-0

Fax 0049-(0)30-746880-99

When a certain Word Clock out pair is not required, disabling it can be reasonable, for example, to reduce extra device radiation, thus improving the EMC conditions in the studio.

(EMC = electromagnetic compatibility)

Due to the internal signal phase corrections the synthesizer can re-lock temporarily when switching AES/EBU clock frequencies. This does not affect the output signals or functionality of iCLOCK.

AES3/-11 clock rates are set independently of externally applied clocks. Thus, iCLOCK provides AES3/-11 clock conversion from all supported input rates to all generatable output rates!



LOCKSTAT (function)

LOCK STATUS This function allows for changing the synchronization status stored in the channel status bits (byte 0, bit 5) of the clear-frame signal of the selected AES/EBU output pair. The factory default is LOCKED.

If the selected AES/EBU output pair is operated in consumer mode, this parameter is not available due to the modified structure of the channel-status bits!

LOCKED, UNLOCKED (Parameter)

LOCKED, UNLOCKED These settings allow for toggling between the locked and unlocked statuses.

Configuring the S/P-DIF Outputs

A clock rate can be set for both S/P-DIF outputs similarly. The channel-status bits can be modified, too.



S/PDIF outputs, page 1



S/PDIF outputs, page 2

S/PDIF OUT/1, -/2 (page name)

The page names refer to the respective S/P-DIF menu page (see above figures).

Functions and settings on the first S/P-DIF output page:

FREQ (function)

FREQUENCY Sets the clock rate of the S/P-DIF outputs. A so-called S/P-DIF clear frame signal (in compliance with AES11) is generated. This signal does not contain any audio information (data bits). The factory default is 44.1kHz.

16.0...192.0kHz (setting)

Altogether twelve different clock rates between 16.0 kHz and 192.0 kHz can be selected. Refer to the »Synchronizable and Generatable Clock Rates« section in the appendix for a full list of all clock rates.

DIST (setting)

DISTRIBUTION This setting allows for forwarding an input S/P-DIF or AES3/-11 signal to the S/P-DIF output pair using a hardware bypass. As no adjustments can be made in this mode, the other functions and parameters will be hidden, and the second menu page of the S/P-DIF pair will not be accessible; the parameters and functions can only be accessed after the internal S/P-DIF generator has been enabled by selecting a different clock rate.

In this mode, the synthesizer synchronizes to the input S/P-DIF or AES3/-11 signal; thus, the video and audio clock signals provided at the other outputs are linked with phase lock to the input signal.

WORDL (function)

WORD LENGTH This function allows for changing the word length stored in the channel status bits of the S/P-DIF clear-frame signal. The factory default is 24BITS.

16BITS, 18BITS, 20BITS, 24BITS (setting)

One of four word lengths between 16 and 24Bits are available for selection.

Due to the internal signal phase corrections the synthesizer can re-lock temporarily when switching S/P-DIF clock frequencies. This does not affect the output signals or functionality of iCLOCK.

S/P-DIF clock rates are set independently of externally applied clocks. Thus, iCLOCK provides S/P-DIF clock conversion from all supported input rates to all generatable output rates!

DIST does not provide redundancy for the S/P-DIF outputs. If the external S/P-DIF or AES3/-11 signal source fails, the S/P-DIF output pair will fail, too!





Setting System Functions

System parameters allow for setting functions that affect no specific output clock formats but all output signals or the global device functionality of iCLOCK. Four menu pages named GLOBAL 1/4 to GLOBAL 4/4 are provided by iCLOCK standard version.

Functions and settings on the GLOBAL 1/4 menu page:



GLOBAL 1/4

GLOBAL 1/4, 2/4, 3/4, 4/4 (page name)
Specifies the name of the currently selected GLOBAL page.

PULLS (function)

With iCLOCK standard version, four different pull-up/down corrective factors can be set for film–video–audio transfers. These settings only affect audio clock signals but not video generator signals. The factory default is OFF.

OFF (setting)

OFF With this setting, all audio clock signal rates will be output unchanged.

+0.1% (setting)

+0,1 % This setting will increase all audio clock output rates by 0.1 %. This factor is required for transferring NTSC video to film.

-0.1% (setting)

-0,1 % This setting will decrease all audio clock output rates by 0.1 %. This factor is required for transferring film to NTSC video.

+4.16% (setting)

+4,16 % This setting will increase all audio clock output rates by 4.1666 %. This factor is required for copying film to PAL video.

-4.0% (setting)

-4,0 % This setting will decrease all audio clock output rates by 4.0 %. This factor is required for transferring PAL video to film.

VARISPEED (function)

VARISPEED This function allows for detuning the synthesizer in steps of 0.0001 % in relation to the selected nominal rate (e.g. 44.1 kHz, 96.0 kHz, etc.). The maximum setting range of the varispeed function is ±20.0 % but may be limited by settings such as the pull-up/down factors or the pull range as well as by instabilities of the synthesizer signal caused by clock source deviation.

Setting Pulls and Varispeed

! PULL and VARISPEED settings will be not stored when switching-off the device!

Unlike conventional clock generators, iCLOCK is capable of synthesizing pull-up/down factors and varispeed in every mode of operation. This is regardless of whether the synthesizer is synchronized internally or by an external source!

More Pull-Up/Down Factors

For special-purpose applications, new pull-up/down factors can be implemented into the system by means of a software update. Practically any factor or algorithm can be applied. The synthesizing accuracy is in the μHz range.

For more information or a proposal, send an e-mail message to tecsupport@iCLOCK-net.de

You may also call us or send a fax:
Phone 0049-(0)30-746880-0
Fax 0049-(0)30-746880-99

1x → [SPEED 0000]

Enable the varispeed function by pressing the up/down cursor buttons one time. (The cursor automatically jumps to the rightmost digit)

3x → [VARISPEED 01] + 1x [ENTER]

Move the cursor to the desired digit (e.g. 0.1%) using the left cursor button. Select the desired value with the up/down cursor buttons (e.g. 1x +0.1%)

1x → [ENTER]

Confirm the setting by pressing the ENTER button.

Entering varispeed values and moving the cursor

Example

The synthesizer is synchronized to an external source with a detuning of -5%. In addition, a varispeed of -16% has been configured. In this case, the synthesizer would correct its output rate only to an amount of -15% of the set varispeed as the total detuning of the input source and the varispeed are -21%, which exceeds the permitted range by 1%.

Varispeed values are set using the up/down cursor buttons. Note that the change will be applied as the button is pressed. Pressing ENTER will confirm the selected value.

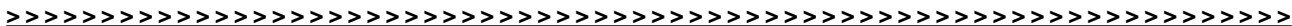



RESET (function)

RESET This function allows for resetting all function and parameter changes to their respective factory defaults, i.e. to the settings of the iCLOCK when it is switched on for the first time.

GO, SURE? (setting)

GO enables the **RESET** function. When the **ENTER** button has been pressed, a confirmation request (**SURE?**) will be displayed. If this request is confirmed by pressing the **ENTER** button again, all current settings will irreversibly be reset to their defaults, and the display will change to the menu main page.

Functions and settings on the GLOBAL 3/4 menu page:



GLOBAL 3/4

ADJ WCLK (function)

ADJUST WORD CLOCK This function allows for editing the four wordclock outputs in common. If a function is edited on any wordclock menu page, any changes will be applied to the same function on all other wordclock menu pages or outputs. This also applies to the outputs of an installed wordclock expansion. The factory default is **SINGLE**.

SINGLE (setting)

SINGLE allows for editing the wordclock outputs individually.

LINKED (setting)

LINKED allows for editing the four Word Clock outputs together by making settings on any Word Clock menu page.

ADJ AES/EBU (function)

ADJUST AES/EBU This function allows for editing the two AES/EBU outputs in common. If a function is edited on any AES menu page, any changes will be applied to the same function on the other AES menu page or output. The factory default is **SINGLE**.

SINGLE (setting)

SINGLE allows for editing the AES/EBU outputs individually.

LINKED (setting)

LINKED allows for editing the two AES/EBU outputs together by making settings on any AES menu page.

DISPLAY (function)

DISPLAY This function allows for choosing whether the backlight LEDs light permanently or whether they will be switched off automatically after a defined period of time. The factory default is **ON**.

ON (setting)

ON lets the backlight LEDs light permanently.

AUTO (setting)

AUTOMATICALLY turns the backlight LEDs after a period of 5 minutes off. Pressing one of the four buttons on the front panel reactivates the backlight LEDs.

Example

If a studio is to be synchronized with an equal clock rate, setting the Word Clock and AES/EBU outputs to **LINKED** is reasonable in order to avoid unnecessary editing on multiple menu pages.

Recommendation

Setting the display to the **AUTO** mode helps saving energy and keeps the lifetime of the backlight LEDs. Furthermore, it will not disturb a reduced illuminated studio environment.



Preset Management

This functionality is available from software versions, V2.10 and V2.11, or higher. Does your iCLOCK or iCLOCKdp not include one of these software versions, please contact your local MUTECH dealer or distributor for an update.

Software V2.11 offers in combination with the new optional iC-ALARM/GPI interface the possibility to switch over different presets externally via GPIO control. If you are working with software V2.10, you need to switch over the presets on the PRESET page.



PRESET

The preset management enables to store eight different set-ups of all function settings which have been set within the whole iCLOCK system menu, as so-called 'Presets'. When switching over the presets, all individual function settings will be switched at one time. Additionally, the preset management stores intermediately the whole current system status permanently in a so-called 'System-Preset'. This system-preset works fail-safe, which provides an automatic function-setting-recovery after, e.g., a mains failure!

When switching on your iCLOCK or iCLOCKdp for the first time, all presets contain of the same factory default settings as described in the previous chapters of this manual. This system condition is equal to this one after a software-reset.

After normal switching on the unit, the last system status stored in the system-preset will be loaded. If this is different compared to the settings of the last active preset, the selected setting under the function OPERATION will be marked with a (*). If you want to work with the current system status, you have to store it in one of the eight available presets. If you prefer to work with that preset, which was active before last switching off/on the unit, you have to load this preset separately.

But if the GPIO preset control is active, your iCLOCK or iCLOCKdp starts using the preset which was previously active, no matter if the system-preset consists of different settings, which are due to changes before switching of the unit.

PRESET (function)

PRESET Within this function menu you can confirm and activate the settings you have choosed within the function menus OPERATION and NAME. Only after this step, the choosed setting will be activated.

GO, SURE ? (setting)

GO enables the setting which is choosed within the function menus OPERATION and NAME. When the ENTER button has been pressed, a confirmation request (SURE?) will be displayed. If this request is confirmed by pressing the ENTER button again, the choosed setting is active.

OPERATION (function)

OPERATION Here you can store and load presets as well as reload the system's default preset.

When a setting within this function menu is marked with a (*), the last preset settings are changed, but have not been stored!

SAVE (setting)

SAVE stores all current system settings under one of the available eight preset numbers (01 – 08). The previously stored settings of this preset will be deleted.

LOAD (setting)

LOAD loads and activates the choosed preset (number).

SET DEF (setting)

SET DEFAULT reloads the factory default settings for the active preset.

Entering the Preset Page

Starting from the main page, press the button pointing downwards for one time to reach the PRESET page immediately.

Software Reset

If a software-reset has been executed with help of the RESET function on GLOBAL 2/4 page, all presets will be deleted and the factory default settings are loaded again.





iCLOCK TECHNOLOGY

Functional Principle

iCLOCK's principle operation is completely different to conventional products. The customer, as a matter of priority, defines the clock rates and formats which are constantly available at the outputs – not depending on the incoming reference signals! Limitations regarding defined combinations of input and output clock signals do not exist for iCLOCK. All inputs and outputs can be routed and combined freely.

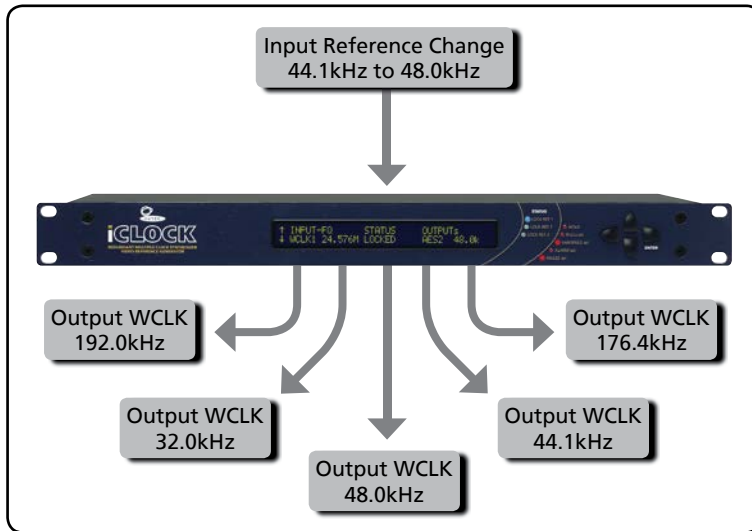

Functional principle during input reference change

Furthermore, unlike standard clock generators, iCLOCK's unique concept enables to set all system functions during any operation mode. This is regardless of whether the synthesizer is synchronized internally or by an external source. Doing this, the powerful synthesis process enables additionally, as an outstanding feature, the use of the pull up/down and varispeed functions simultaneously! Thus any conceivable adaption of the outgoing basic clock rates is possible with iCLOCK.

During this process the system detects automatically useful phase relationships between the reference input and generated output signals. Adjustments aligned to AES11-1997/2003 and EBU R83-1996 will be executed in realtime independently.

SoftReLock

SoftReLock is a special system routine executed by the synthesizer in every operation mode of reference change or reference resynchronization. Especially in cases of the later described SEQSYNC or CYCLESYNC functions, SoftReLock guarantees a gradual and seamless synchronization update of the internal signal generators, or all iCLOCK output signals respectively, to the basic clock rate of a new or reestablished reference source. Also if complete different reference types of unequal sources are synchronized in succession, e.g. NTSC video after pulled down 48.0kHz AES11, the SoftReLock routine ensures interruption-free and gently adjustment of iCLOCK's output signals to the new reference.

SoftReLock represents one of the most important functions to support the system's ability providing continous clock supply under all imaginable operation modes.

Example

iCLOCK is synchronized by an external Word Clock reference with 44.1kHz. The outputs are adjusted to different clock rates (see adjacent diagram). If the external reference changes to 48.0kHz, the predefined outgoing clock rates will remain unchanged!

The reason is that iCLOCK's intelligent synthesis process synchronizes every reference signal phase-locked and converts it simultaneously into the adjusted output clock rates. Thus the typical signal distribution effect, »a change of input clock rate changes all output clock rates«, is prevented in general. The adjusted output clock rates are permanently available, not depending on the frequency or format of the incoming reference!



APPENDIX

Synchronizable HD tri-level Standards and Frame Rates

HD tri-level 24/25/30/50/60Hz – REF: HD-P-1/2		HD tri-level 23.98/29.97/59.94Hz – REF: HD-N-1/2	
Resolution	Frame Rate	Resolution	Frame Rate
1280 x 720p	50Hz	1280 x 720p	59.94Hz
1280 x 720p	60Hz	1920 x 1080p	23.98Hz
1920 x 1080p	24Hz	1920 x 1080p	29.97Hz
1920 x 1080p	25Hz	1920 x 1080p	59.94Hz
1920 x 1080p	30Hz	1920 x 1080i/PsF	23.98Hz
1920 x 1080p	50Hz	1920 x 1080i/PsF	29.97Hz
1920 x 1080p	60Hz	1920 x 1080i/PsF	59.94Hz
1920 x 1080i/PsF	24Hz	<p>The above mentioned HD tri-level standards and frame rates can be converted into NTSC standard definition 29.97Hz when the internal video reference generator's format is set to »NTSC«.</p> <p>When locking your iCLOCK or iCLOCKdp to HD tri-level references, their individual frame rates can not be displayed correctly under »STATUS«, as it is the case when locking SD bi-level references. This is due to system reasons. But your iCLOCK will be locked as it should be.</p>	
1920 x 1080i/PsF	25Hz		
1920 x 1080i/PsF	30Hz		
1920 x 1080i/PsF	50Hz		
1920 x 1080i/PsF	50Hz		
1920 x 1080i/PsF	60Hz		

The above mentioned HD tri-level standards and frame rates can be converted into PAL standard definition 25Hz when the internal video reference generator's format is set to »PAL«.

Synchronizable and generatable Clock Rates

WORD CLOCK RATES			
Dividers/Factors	Basic Clock: 32.0 kHz	Basic Clock: 44.1 kHz	Basic Clock: 48.0 kHz
/4	8.0	11.025	12.0
/2	16.0	22.05	24.0
x1	32.0	44.1	48.0
x2	64.0	88.2	96.0
x4	128.0	176.4	192.0
x8	256.0	352.8	384.0
x16	512.0	705.6	768.0
x32	1024.0	1411.2	1536.0
x64	2048.0	2822.4	3072.0
x128	4096.0	5644.8	6144.0
x256	8192.0	11289.6	12288.0
x512	16384.0	22579.2	24576.0

PILOT TONE CLOCK RATES			
Type	PAL/SECAM (Hz)	NTSC (Hz)	Film (Hz)
Color Frame Rate	25	29.97	24
Color Field Rate	50	59.94	48
Black + White Frame Rate	–	30	–
Black + White Field Rate	–	60	–

All clock rates are generatable only, not synchronizable!

GPS / ATOMIC CLOCK RATES + AUDIO PLAYER BASIC CLOCK	
Type	(MHz)
GPS / ATOMIC CLOCK	1.0
GPS / ATOMIC CLOCK	2.5
GPS / ATOMIC CLOCK	5.0
GPS / ATOMIC CLOCK	10.0
AUDIO PLAYER BASIC CLOCK *	16.9344

*) This clock rates is generatable only, not synchronizable!

Connecting the universal Clock Inputs to Ground

CAUTION! Disconnect the unit from the mains before opening!
Remount the steel-plate cover thoroughly before you attempt to operate the unit!

When iCLOCK is shipped, the BNC-based universal inputs are isolated from ground.

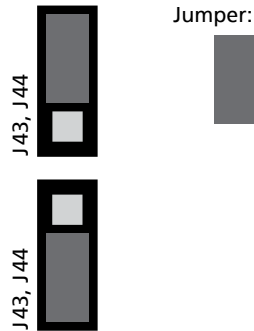

Setting the jumper one pin forward in direction to the housing's backside will connect the according BNC input connector to ground. Both inputs can be set independently.

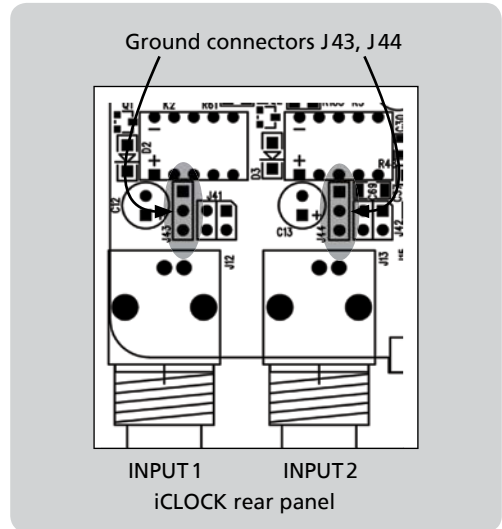

Switching-off the Termination of the universal Clock Inputs

CAUTION! Disconnect the unit from the mains before opening!
Remount the steel-plate cover thoroughly before you attempt to operate the unit!

When iCLOCK is shipped, the BNC-based universal inputs are terminated internally with 75Ω. Two Jumpers are put on two 2-pin sockets, J41 for INPUT 1 and J42 for INPUT 2.

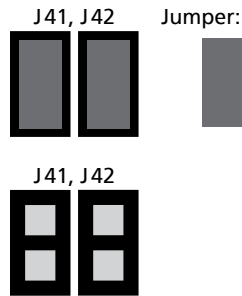

Removing the jumpers from the two 2-pin sockets will switch off the 75Ω termination for the according universal BNC input connector.

We recommend to keep the jumpers to be able to reactivate the termination for other applications!

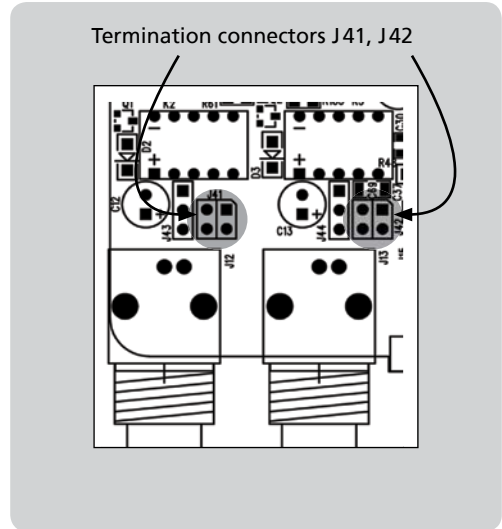

Splitting-up the Video Outputs for dual Video Generator Operation

CAUTION! Disconnect the unit from the mains before opening!
Remount the steel-plate cover thoroughly before you attempt to operate the unit!

When iCLOCK is shipped, the two BNC-based video output pairs are transferring the video signal of the internal video reference generator simultaneously. Two Jumpers are put on two 2-pin sockets, J16 and J17.

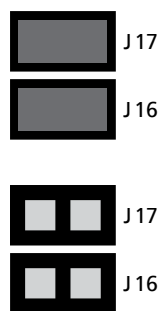

Removing the jumpers from the 2-pin sockets will split up the dual video BNC output connectors for two video generators as follows.

- VIDEO OUT 1 = internal video reference generator
- VIDEO OUT 2 = optional video generator

We recommend to keep the jumpers to be able to reactivate the termination for other applications!

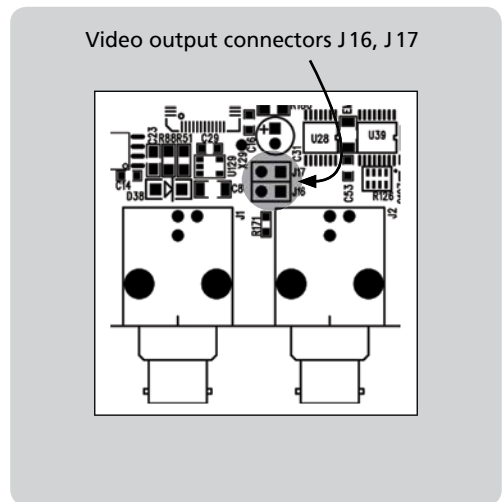



WWW.MUTEC-NET.DE
FON 0049-(0)30-74 6880-0
FAX 0049-(0)30-74 6880-99