

User's Guide



OctaMic XTC

The Professional's Multi-format Solution

AutoSet[™]

SteadyClock[™]

QuickGain[™]

Professional Mic/Line/Instrument Preamp
8-Channel Microphone / Line AD-Converter
4-Channel Line/Phones DA-Converter
8-Channel Analog to AES / ADAT Interface
64-Channel MADI Interface
ADAT / AES / MADI Format Converter
24 Bit / 192 kHz Digital Audio
MIDI Remote Control
USB 2.0 Class Compliant Operation



AES-3
AES-10

24 Bit Interface

▶	Important Safety Instructions	4
---	--	---

▶ **General**

1	Introduction	6
2	Package Contents	6
3	Brief Description and Characteristics	6
4	First Usage – Quick Start	
4.1	Controls - Connectors - Displays	7
4.2	Quick Start	9
5	Accessories	9
6	Warranty	10
7	Appendix	10

▶ **Usage and Operation**

8	Front Panel Controls	
8.1	Select Keys	14
8.2	Encoders	14
8.3	Menu Keys	15
8.4	Channel Menu.....	16
8.5	Setup Menu	18
8.5.1	Options Menu.....	18
8.5.2	Setups Menu	20
8.6	Clock	21
9	The Input Channel in Detail	
9.1	Gain.....	22
9.2	Phantom Power.....	22
9.3	AutoSet.....	23
9.4	Instrument / Line	23
10	Using Multiple Units with MADI	
10.1	Delay Compensation.....	24
10.2	Compensation ID	26
11	Remote Control	
11.1	MIDI.....	26
11.2	MIDI over MADI.....	26
11.3	Control via TotalMix FX.....	26

▶ **Inputs and Outputs**

12	Analog Inputs / Outputs	
12.1	Mic / Line In (XLR)	28
12.2	Line In (TRS).....	28
12.3	Instrument In	28
12.4	Phones / Line Out	29
13	Digital Inputs and Outputs	
13.1	AES / EBU.....	30
13.2	ADAT Optical	31
13.3	MADI	32
14	Word Clock	
14.1	Word Clock Input and Output.....	34
14.2	Technical Description and Background	35
14.3	Cables and Termination.....	36
15	MIDI	36

▶ **Class Compliant Mode**

16	General	38
17	System Requirements	38
18	Operation	38
18.1	Useful Hints.....	39
18.2	Class Compliant under Windows/Mac OS X	40
19	Supported Inputs and Outputs	41
20	Operation at the Unit	41

▶ **Technical Reference**

21	Technical Specifications	
21.1	Analog.....	44
21.2	Digital Inputs	45
21.3	Digital Outputs	46
21.4	Digital	46
21.5	MIDI	46
21.6	General	47
21.7	Firmware	47
21.8	MADI User Bit Chart	47
21.9	Connector Pinouts	48
22	Technical Background	
22.1	Terminology	50
22.2	Lock and SyncCheck	51
22.3	Latency and Monitoring	52
22.4	DS – Double Speed	53
22.5	QS – Quad Speed	53
22.6	AES/EBU – SPDIF.....	54
22.7	Signal to Noise ratio in DS- / QS-Operation	55
22.8	MADI Basics	56
22.9	SteadyClock.....	57
23	Block Diagram	58
24	MIDI Implementation OctaMic XTC	
24.1	Basic SysEx Format	56
24.2	Message Types - Commands.....	56
24.3	Table	57

Important Safety Instructions



ATTENTION! Do not open chassis – risk of electric shock

The unit has non-isolated live parts inside. No user serviceable parts inside. Refer service to qualified service personnel.



Mains

- The device must be earthed – never use it without proper grounding
- Do not use defective power cords
- Operation of the device is limited to the manual
- Use same type of fuse only



To reduce the risk of fire or electric shock do not expose this device to rain or moisture. Prevent moisture and water from entering the device. Never leave a pot with liquid on top of the device. Do not use this product near water, i. e. swimming pool, bathtub or wet basement. Danger of condensation inside – don't turn on before the device has reached room temperature.



Installation

Surface may become hot during operation – ensure sufficient ventilation. Avoid direct sun light and do not place it near other sources of heat, like radiators or stoves. When mounting in a rack, leave some space between this device and others for ventilation.



Unauthorized servicing/repair voids warranty. Only use accessories specified by the manufacturer.



Read the manual completely. It includes all information necessary to use and operate this device.

User's Guide



OctaMic XTC

▶ General

1. Introduction

The OctaMic XTC is extremely versatile. It offers a hi-end 8-channel microphone preamplifier with AD-conversion, compatible to hi-level line signals and Hi-Z instruments. A 4-channel DA-conversion serves monitoring and as digital return path. The digital outputs ADAT, AES/EBU and MADI exist also as inputs, providing insert capabilities as well as digital conversion and splitting between these formats. In Class Compliant mode the XTC operates as audio interface with current Macs, and when using a Camera Connection Kit even with the iPad. The latter is especially interesting, as the XTC is equipped with any analog and digital I/Os, therefore being the perfect universal interface for this platform. Add the sheer number of 24 I/O-channels in CC mode, and the XTC is clearly on top of any comparable device.

2. Package Contents

Please check that your OctaMic XTC package contains each of the following:

- OctaMic XTC
- Power cord
- Manual
- 1 optical cable (TOSLINK), 2 m

3. Brief Description and Characteristics

The OctaMic XTC is a full range hi-end preamp and AD/DA-converter in reference quality, fully remote controllable. In a standard 19" box with 1 unit height the device offers numerous extraordinary features like Intelligent Clock Control (ICC), SyncCheck, SteadyClock, QuickGain, AutoSet, MIDI over MADI, and remote control via USB, MADI and MIDI.

- 8 balanced XLR microphone inputs
- 4 TRS line, 4 TS instrument inputs
- 85 dB gain range
- Analog input level from -53 dBu up to $+32$ dBu
- High-end circuitry with relay and super low-noise microphone front-end
- Large frequency range (200 kHz) with special EMI input filtering
- 2 unbalanced stereo line / phones outputs
- Near click-free gain changes
- AutoSet: Automatic gain reduction with multiple linking
- Current state can be stored to 6 user presets
- Fully remote controllable
- Word clock input and output
- SyncCheck tests and reports the synchronization status of the clock signals
- MIDI I/O
- 4 x AES/EBU Out per D-sub, 8 channels @ 192 kHz
- 2 x ADAT Out, 8 channels @ 96 kHz
- MADI I/O (64 channels @ 48 kHz)

4. First Usage – Quick Start

4.1 Controls - Connectors - Displays

The front of the OctaMic XTC features eight Select keys, 32 status LEDs, two stereo TRS outputs, four menu keys, two rotary encoders with push functionality and a graphical colour display.

Each channel has three LEDs showing the current state of PAD/INST, 48V and signal. The channel's **Select** key gives quick access to the gains of the corresponding input channels, which are then immediately adjustable via the rotary encoders 1 and 2. The display also includes two level meters for exact level calibration. When the Select key is held pressed two lines are shown between 1 and 2, indicating stereo mode. Both channels are then adjusted simultaneously by one encoder.

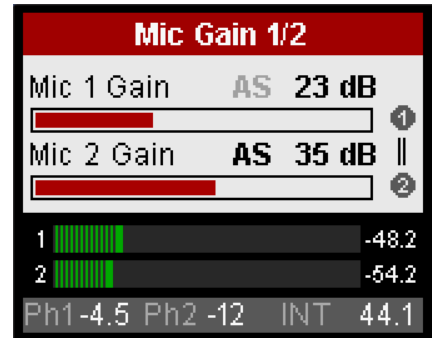

Input 1 to 4 include optional attenuation against too high input levels (PAD, -20 dB). This setting is found in the CHANNEL menu. The 1/4" TRS input within the XLR socket operates like the XLR input, but is 9 dB less sensitive.

The 1/4" TS inputs of channels 5 to 8 is unbalanced and has a high impedance. It is optimized to be used with instruments, and also activated in the CHANNEL menu.

The key **PHONES** gives immediate access to the Phones output level by encoder 1, and a selection of the signal source by encoder 2. The volume of Phones 1/2 is directly controlled by encoder 1 and 2 when the display shows the level meter overview.

The key **GROUPS** brings up the group screen. Encoder 1 changes between Group All and Group 1 to 4. Encoder 2 changes all gains of the corresponding group simultaneously.

The key **CHANNEL** gives access to:

Pre Amp Gain	Amount of amplification
AutoSet Gain	Automatic gain reduction
Gain Group	Select one of four groups
+48V	Phantom power (XLR only)
PAD / Instrument	Input attenuation -20 dB / Switch to 1/4" TS
Phase Invert	Phase inversion (180°)
Mute	Mutes the current channel

The key **SETUP** offers several options to configure the device. Encoder 1 changes between *Options* and *Setups*. The sub-menus in *Options*, *General Settings*, *Digital Routing*, *Clock* and *MIDI Sources*, are accessed with encoder 2.

Pressing any of these keys again exits the current menu and returns to the level meter overview.

In the STATE area 8 LEDs provide a quick overview. SYNC indicates whether the external signals word clock, AES, ADAT and MADI are present and valid. Incoming and outgoing MIDI data is signaled in the MIDI area. CTRL I and CTRL O show in- and outgoing remote control commands, no matter which port is used. ALL I and ALL O signal general MIDI data, again on any port. A more detailed display of the incoming data is included in the *SETUP – Options – MIDI Sources* screen (see chapter 8.5).

The rear panel of the OctaMic XTC has eight analog inputs, mains power, a USB 2.0 port, MIDI I/O, word clock I/O, MADI I/O, ADAT I/O and AES/EBU I/O.

BALANCED MICROPHONE / LINE INPUTS (XLR/TRS combo socket): Eight balanced *full range mic/line/inst inputs* with 85 dB gain range.

ADAT IN (TOSLINK): Optical ADAT input (clock synchronization, monitoring, format conversion).

ADAT OUT (TOSLINK): Two optical ADAT outputs. These carry full 8 channels in S/MUX2 mode (96 kHz), and 4 channels at 176.4 / 192 kHz.

WORD IN (BNC): In menu *Options – Clock* the input can be set to be terminated with 75 Ohms.

WORD OUT (BNC): Standard word clock output.

MADI I/O optical: Standard optical MADI ports.

AES/EBU I/O (25-pin D-sub): The D-sub connector provides four AES/EBU outputs (AD signals) and four AES/EBU inputs (clock synchronization, monitoring, format conversion). The 25 pin D-sub connector is wired according to the widely spread Tascam standard (pinout see chapter 13.1). The AES I/Os are transformer-coupled. The high sensitivity type input accepts all common digital sources, even SPDIF.



USB 2.0: Windows: Firmware update. Mac OS X: Class Compliant audio interface and firmware update. iPad: Class Compliant audio interface via Camera Connection Kit.

MIDI I/O (5-pin DIN): MIDI input and output via 5-pin DIN jacks. Used to remote control the OctaMic XTC, and to transmit MIDI data via MADI or USB.

IEC receptacle for power connection. The specially developed, internal hi-performance switch mode power supply lets the OctaMic XTC operate in the range of 100V to 240V AC. It is short-circuit-proof, has an integrated line-filter, is fully regulated against voltage fluctuations, and suppresses mains interference.

4.2 Quick Start

After connection of all cables and power-on of the device, the configuration of the OctaMic XTC starts in the menu **SETUP – Options - Clock**. Choose a clock source and a sample rate.

The next step is the **GAIN** setting. Press the desired **SELECT** button and adjust the gain with the encoders, so that the two level meters do not show overload.

The digital output to send out the converted analog signal is defined in **SETUP – Options – Digital Routing**. Press encoder 2 to navigate downwards through the list, for example to **ADAT Out**. By turning encoder 2 the signal source of the ADAT output can be set to **Mic 1-8** (default).

The OctaMic XTC stores all settings before switching off, and sets them automatically when switching on the next time. The storing process is triggered 5 seconds after the last change.

5. Accessories

RME offers several optional components for the OctaMic XTC:

Part Number	Description
OK0050	Optical cable, Toslink, 0.5 m (1.7 ft)
OK0100	Optical cable, Toslink, 1 m (3.3 ft)
OK0200	Optical cable, Toslink, 2 m (6.6 ft)
OK0300	Optical cable, Toslink, 3 m (9.9 ft)
OK0500	Optical cable, Toslink, 5 m 16.4 ft)
OK1000	Optical cable, Toslink, 10 m (32.8 ft)
BO25MXLR4M4F1PRO	Digital Breakout Cable Pro, AES/EBU 25-pin D-sub to 4 x XLR male + 4 x XLR female, 1m (3.3 ft)
BO25MXLR4M4F3PRO	same, 3 m (9.9 ft)
BO25MXLR4M4F6PRO	same, 6 m (19.8 ft)
BO25M25M1PRO	Digital D-sub cable Pro, AES/EBU 25-pin D-sub to 25-pin D-sub, 1m (3.3 ft)
BO25M25M3PRO	same, 3m (9.9 ft)
BO25M25M6PRO	same, 6m (19.8 ft)
BOB32	BOB-32, Universal breakout box, 19" 1 Unit height. The professional digital AES/EBU breakout solution

6. Warranty

Each individual OctaMic XTC undergoes comprehensive quality control and a complete test at IMM before shipping. The usage of high grade components should guarantee a long and trouble-free operation of the unit.

If you suspect that your product is faulty, please contact your local retailer.

Audio AG grants a limited manufacturer warranty of 6 months from the day of invoice showing the date of sale. The length of the warranty period is different per country. Please contact your local distributor for extended warranty information and service. Note that each country may have regional specific warranty implications.

In any case warranty does not cover damage caused by improper installation or maltreatment - replacement or repair in such cases can only be carried out at the owner's expense.

No warranty service is provided when the product is not returned to the local distributor in the region where the product had been originally shipped.

Audio AG does not accept claims for damages of any kind, especially consequential damage. Liability is limited to the value of the OctaMic XTC. The general terms of business drawn up by Audio AG apply at all times.

7. Appendix

RME news and further information can be found on our website:

<http://www.rme-audio.com>

Distributor: Audio AG, Am Pfanderling 60, D-85778 Haimhausen, Tel.: (49) 08133 / 918170

Manufacturer:

IMM Elektronik GmbH, Leipziger Strasse 32, D-09648 Mittweida

Trademarks

All trademarks and registered trademarks belong to their respective owners. RME, Hammerfall and DIGICheck are registered trademarks of RME Intelligent Audio Solutions. QuickGain, SyncAlign, SyncCheck, SteadyClock and OctaMic XTC are trademarks of RME Intelligent Audio Solutions. Alesis and ADAT are registered trademarks of Alesis Corp. ADAT optical is a trademark of Alesis Corp. S/MUX is copyright Sonorus. Microsoft and Windows are registered trademarks of Microsoft Corp. Apple, iPad and Mac OS are registered trademarks of Apple Inc.

Copyright © Matthias Carstens, 12/2013. Version 1.2

All entries in this User's Guide have been thoroughly checked, however no guarantee for correctness can be given. RME cannot be held responsible for any misleading or incorrect information provided throughout this manual. Lending or copying any part or the complete manual or its contents as well as the software belonging to it is only possible with the written permission from RME. RME reserves the right to change specifications at any time without notice.

CE / FCC Compliance

CE

This device has been tested and found to comply with the limits of the European Council Directive on the approximation of the laws of the member states relating to electromagnetic compatibility according to RL2004/108/EG, and European Low Voltage Directive RL2006/95/EG.

FCC

This equipment has been tested and found to comply with the limits for a Class B digital device, pursuant to Part 15 of the FCC Rules. These limits are designed to provide reasonable protection against harmful interference in a residential installation. This equipment generates, uses, and can radiate radio frequency energy and, if not installed and used in accordance with the instructions, may cause harmful interference to radio communications. However, there is no guarantee that interference will not occur in a particular installation. If this equipment does cause harmful interference to radio or television reception, which can be determined by turning the equipment off and on, the user is encouraged to try to correct the interference by one or more of the following measures:

- Reorient or relocate the receiving antenna.
- Increase the separation between the equipment and receiver.
- Connect the equipment into an outlet on a circuit different from that to which the receiver is connected.
- Consult the dealer or an experienced radio/TV technician for help.

RoHS

This product has been soldered lead-free and fulfils the requirements of the RoHS directive.

ISO 9001

This product has been manufactured under ISO 9001 quality management. The manufacturer, IMM Elektronik GmbH, is also certified for ISO 14001 (Environment) and ISO 13485 (medical devices).

Note on Disposal

According to the guide line RL2002/96/EG (WEEE – Directive on Waste Electrical and Electronic Equipment), valid for all european countries, this product has to be recycled at the end of its lifetime.

In case a disposal of electronic waste is not possible, the recycling can also be done by IMM Elektronik GmbH, the manufacturer of the OctaMic XTC.

For this the device has to be sent **free to the door** to:

IMM Elektronik GmbH
Leipziger Straße 32
D-09648 Mittweida
Germany



Shipments not prepaid will be rejected and returned on the original sender's costs.



User's Guide



OctaMic XTC

▶ Usage and Operation

8. Front Panel Controls

8.1 Select Keys

The four channel keys labeled SELECT offer quick selection and setting of the gain. After pressing one of the four keys the page **Mic Gain** of the corresponding pair is shown in the display. The gain can now be adjusted immediately with encoder 1 and 2. This method guarantees an immediate access to the most important parameters of the device, and makes 8 separate encoders (pots) on the front panel obsolete.

For a similar reason and despite the informative display the front panel still has dedicated LEDs for signal and overload (bi-color SIG LED). If overload/distortion is caused by too high gain one simply hits the key SELECT where the overload is displayed, to then reduce the gain with encoder 1 or 2 – lightning quick and intuitive.

Apart from the group function the typical pairs of channels (1/2, 3/4...) can be adjusted simultaneously directly from the front panel. Press and hold the SELECT key so that the display shows two lines between the encoder symbols 1 and 2. This so called Linked or Ganging mode operates in a relative way, different gains of either channel are retained when changing them both.

8.2 Encoders

The encoders can be turned endlessly, but also pressed, adding a key function. Their current functionality is clearly shown in the display. In general turning them either changes the current parameter, or moves the selection/cursor horizontally to the next page. Pressing the encoders moves the selection/cursor vertically, up with 1 and down with 2, as indicated by the arrows in the display.

On the gain pages brought up by the channel's SELECT key pressing encoder 1 and 2 activates the AutoSet function. The label AS in the display changes from light gray to solid black (see picture in chapter 4.1).

Example: Press the key SETUP. The menu *Setups* is now shown in the display. The number 1 within the circle on the right side indicates that by turning encoder 1 more pages are available. In this case only one, *Options*. *Setups* itself has no further sub-pages. By pressing encoder 2 the cursor moves down, by pressing encoder 1 it moves back up. On a selected field or entry, the 2 to the right indicates that the current parameter can be changed by turning encoder 2.

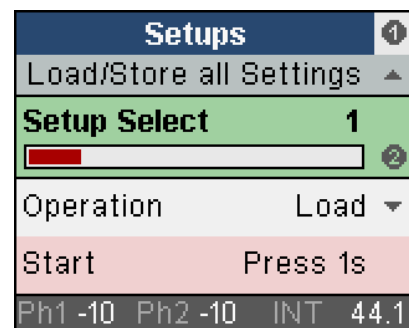

On the Options page several sub-pages exist, therefore a 2 is shown on the right side of those sub-pages. By turning encoder 2 the pages *Clock*, *MIDI Sources*, *General Settings* and *Digital Routing* are shown. The arrow under the 2 indicates that pressing encoder 2 the corresponding page is entered, and settings can be changed then.

8.3 Menu Keys

The keys to the left of the display simplify navigation, as they directly jump to specific areas.

PHONES

This key brings up the *Phones 1* screen, where the output level can be directly controlled with encoder 1, and the signal source with encoder 2. Pressing PHONES again changes to *Phones 2*.

The volume of Phones 1/2 can be adjusted directly with encoder 1 and 2 when the level meter overview is shown in the display. In that case there is no choice for the signal source.

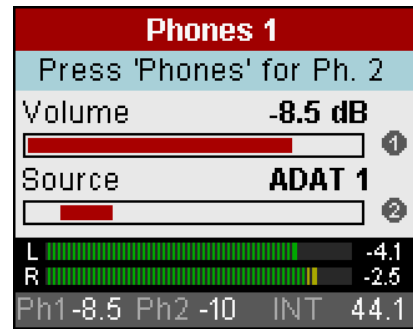

GROUPS

The key **GROUPS** brings up the group screen. Encoder 1 changes between *Group All* and *Group 1* to *4*. Encoder 2 changes all gains of the corresponding group simultaneously. Their relative values (the differences of gains between channels) are retained.

Group All

Current group settings are ignored, all 8 channels are affected by gain changes.

Group 1 to 4

The channels not assigned to any group are shown in light gray to the left (channel number) and right (current gain). The level meter is always active for all channels. The OctaMic XTC has 8 channels, therefore no more than 4 groups with 2 channels each can be defined. The group assignment is defined in the menu CHANNEL - Gain Group.

Pressing encoder 2 activates the currently selected group, another push activates the AutoSet function (AS) for this group. Pressing the encoder a third time switches both functions off.

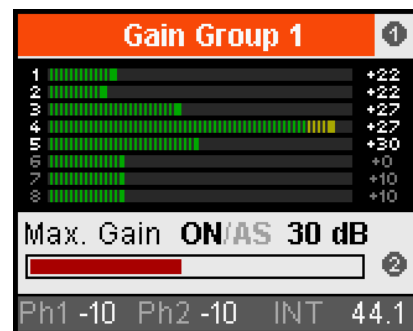

CHANNEL

This key gives access to the settings of the analog inputs *Mic 1* to *8*, and the analog outputs *Phones 1* and *2*.

SETUP

Direct access to *Setups* and *Options*, the latter having the sub-pages *Clock*, *MIDI Sources*, *General Settings*, *MADI Settings* and *Digital Routing*. A screenshot is shown on the left page (chapter 8.2).

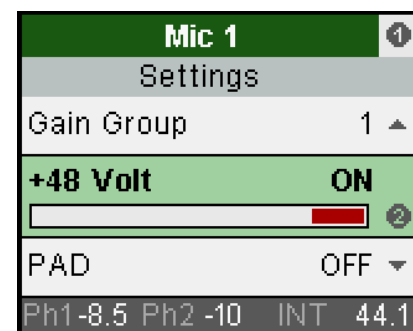

8.4 Channel Menu

Mic 1 to 8, Settings, has the following entries:

Pre Amp Gain

Sets the current gain/amplification. Choices are 0 dB, and +10 up to +65 dB in steps of 1 dB.

AutoSet Gain

Automatic overload protection by gain reduction in case of overload. **AutoSet** tries to keep a headroom of 6 dB. Levels higher than -6 dBFS will permanently reduce the gain. To check set the channels to a high gain and apply an input signal. The displayed gain will quickly decrease to a gain that is appropriate. While AutoSet in the XTC is not exactly the same as in the RME Micstasy (with extreme overloads distortion will occur for the fraction of a second before the level is set correctly), it works quite well in real-world applications and will prevent distorted recordings reliably.

AutoSet can be activated in CHANNEL as well as on the gain pages brought up by the channel's SELECT key: a push on encoder 1 and 2 activates AutoSet. The label AS in the display changes from light gray to black.

With grouped channels the field **AutoSet Gain** is grayed out, activating AutoSet is then done in the Groups page.

To avoid shifts in panorama AutoSet should work ganged with stereo channels, so that gain changes of one channel are also applied to the other one. This function is part of the groups and thus available for up to 8 channels simultaneously. This also means that for using ganged AutoSet a stereo pair (like Mic1/2) has to be defined and activated explicit as group.

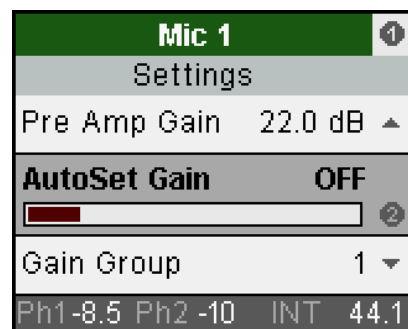

As soon as AutoSet reduces the gain the label AS, shown in the front display, changes its color from black to blue.

Gain Group

Assigns channels to one of four groups. Choices are None or 1 to 4.

+48V

Activates phantom power for condenser microphones or special accessories (Alva Test Plug). Phantom power should only be activated when condenser microphones that require such a power supply are used, and only in the specific channel. Additionally always make sure the microphone is plugged in first before the phantom power is switched on. The OctaMic XTC turns on the phantom power smoothly (soft start). Connecting and disconnecting microphones while phantom power is active causes a high voltage surge, which can destroy the sensitive microphone input stage.

Phantom power is only applied to the XLR socket, the inner TRS contacts do not carry any voltage.

PAD (Channels 1-4)

Channels 1 to 4 have an optional attenuator directly at the input stage. PAD reduces the signal level by -20 dB, avoiding overload when feeding high-level line signals. XLR and TRS socket are active at the same time, no switching between them is required. An active PAD is signaled by an LED on the front panel.

Instrument (Channels 5-8)

Channels 5 to 8 have a high impedance instrument input. This function switches from the XLR to the TRS socket. The current state is signaled by an LED on the front panel.

Phase Invert

Phase changes the polarity (180°). Useful to fix wrongly soldered cables or to eliminate sound and phase errors.

Mute

Muting a channel. Allows to remove a signal without the need to change the current gain.

Phones 1 and 2 has the following entries:

Volume

Sets the output level from -64 dB up to +6 dB, in steps of 1 dB. Mute is also available.

Balance

Adjustable from -1 (left) through 0 (middle) to +1 (right).

Source

Selection of the signal source. Play 1/2 and 3/4 relate to software playback in Class Compliant mode. Mic 1 to 8 provides monophonic monitoring of the selected input, Mic 1/2 to 7/8 the same in stereo. Mic 1-8S performs a mixdown of all 8 input channels to the Phones output. Next choices are single channel and stereo channels of the digital inputs ADAT, AES and MADI.

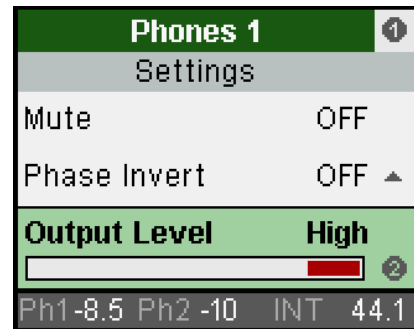

Mute

Mute of the phones output, without the need to change the current volume setting..

Phase Invert

Available settings are Off, Both, Left and Right.

Output Level

Can be set to Low or High.

8.5 Setup Menu

SETUP offers several options to configure the device. Encoder 1 changes between *Options* and *Setups*. The sub-menus in *Options*, *General Settings*, *Digital Routing*, *Clock* and *MIDI Sources*, are accessed with encoder 2.

Pressing any of these keys again exits the current menu and returns to the level meter overview.

8.5.1 Options Menu

The page *Clock* has the following entries:

Clock Source

Choices are INT (Internal, Master), WCK (Wordclock), AES 1 to 4, MADI and ADAT.

Sample Rate

Choices are 32, 44.1, 48, 64, 88.2, 96, 128, 176.4 and 192 kHz. Setting the correct sample rate is even necessary in slave mode, with external clocking via word or one of the digital inputs. Only with AES the real current sample rate can be detected. With the other S/MUX formats the user has to inform the unit, whether the input signal is in the single, double or quad speed range.

WCK Alw. Singl

Word Clock Always Single Speed. Choices are On or Off.

WCK Term.

Word clock termination for the word clock input – On or Off.

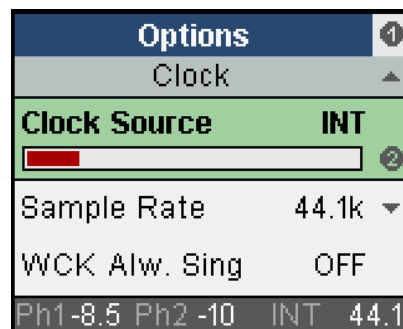

The page *General Settings* has the following entries:

MIDI Device ID

Adjustable from 0 to 7.

MIDI Contr. Thru

On or Off.

LCD Contrast

Adjustable from -20% to +20%. Default is 0%.

SW-Version

Shows the current version number and date of the internal software.

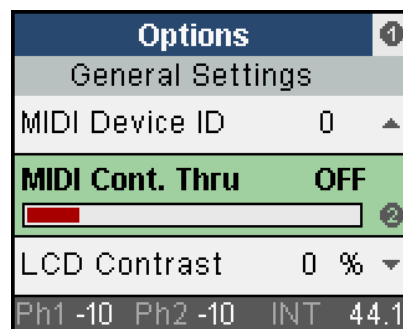

The page **MADI Settings** has the following entries:

Delay Comp.

Delay Compensation. Choices are Off, Manual, Auto-ID, Auto-CA (Channel Assignment)

Compens. ID

Manual setting of the Compensation ID, from 1 to 8. Grayed out when Auto-ID or Auto-CA are active.

MADI Format

Can be set to 56 or 64 channels.

MADI Frame

Can be set to 48k or 96k.

These options are explained in detail in chapter 10.

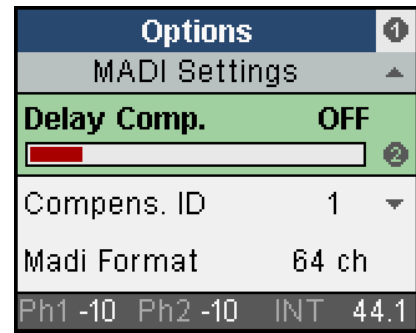

The page **Digital Routing** has the following entries:

ADAT Out

Sets the signal source of the ADAT output. Choices are Mic 1-8, ADAT In, AES In, MADI In in groups of eight, Playback 1-8, 5-12, 9-16,13-20, 17-24.

ADAT 2 Out

See ADAT Out.

AES Out

See ADAT Out.

MADI 1-8 etc

See ADAT Out. All eight 8-channel groups of the MADI output can be freely assigned to the above signal sources.

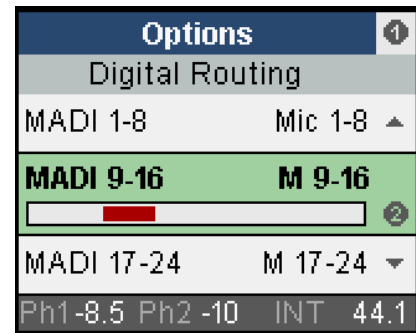

Recording

Inputs 1 to 8 are fixed to the USB (Class Compliant mode) recording channels 1 to 8. The Class Compliant mode of the XTC provides a total of 24 recording and playback channels each. Channels 9 to 24 are freely assignable in this menu:

Rec. 9-16

Choices are Mic 1-8, ADAT In, AES In, MADI In in groups of 8 channels

Rec. 17-24

Choices are Mic 1-8, ADAT In, AES In, MADI In in groups of 8 channels

The page *MIDI Sources* has the following entries:

In the lower part of the display 5 fields, one for each MIDI input, show incoming MIDI signals. DIN is the rear 5-pin socket, USB1/2 the according USB MIDI port (only available with an active USB connection) and MADI, which – thanks to RME’s MIDI over MADI technology - can also receive MIDI from other devices.

The field Contr. (Control) reacts only on dedicated remote control commands for the XTC.

Control (Inp.)

Defines from which port the XTC receives remote control commands. Choices are USB1, USB2, MADI In, DIN In, Off.

USB MIDI 1 / USB MIDI 2

Defines the source of the data sent to the USB MIDI ports 1 or 2. Choices are USB1, USB2, MADI In, DIN In, Control, Off. The source Control means feedback / response / status data sent by the XTC.

MIDI DIN out

Defines the source of the data sent to the MIDI DIN output. Choices are USB1, USB2, MADI In, DIN In, Control, Off. The source Control means feedback / response / status data sent by the XTC.

MIDI ov. MADI

Defines the source of the data sent via MIDI over MADI to the MADI output. Choices are USB1, USB2, MADI In, DIN In, Control, Off. The source Control means feedback / response / status data sent by the XTC.

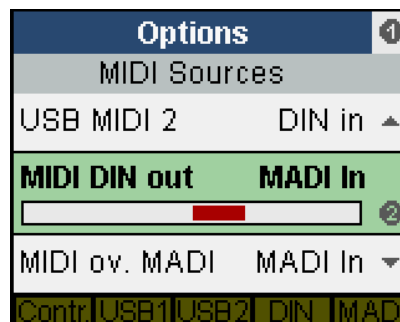

8.5.2 Setups Menu

The page *Setups, Load/Store all Settings*, has the following entries:

Setup Select

Choices are memory slots 1 to 6 and Factory (factory default).

Operation

Choices are Load and Store.

Start

Press 1s. Pressing and holding encoder 2 for at least one second triggers the action selected in Operation.

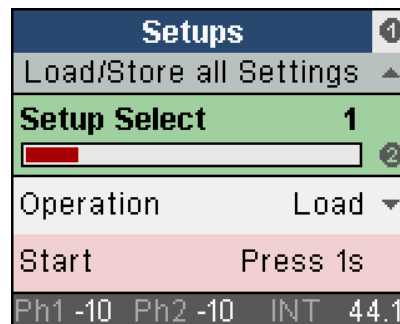

8.6 Clock Section

Source and frequency of the unit's clock are configured in *Options – Clock*. Clock Source offers several choices for the current clock source: internal clock or external clock (WCK = Word clock, AES 1 to 4, MADI, ADAT). Sample Rate sets the sample rate for both external and internal clock.

WCK, AES 1-4, MADI, ADAT (Slave Mode)

Activates the corresponding input as clock reference. In case of a missing or invalid clock source signal the display of the current sample rate in the lower right corner of the display turns to red, then the unit changes to its internal clock.

INT (Master Mode)

Activates the internal clock.



With a setting of INT (internal clock) it is mandatory that the clock rate of the sources is synchronous to the OctaMic XTC. Therefore the external device has to be synchronized to the OctaMic XTC word clock output or AES/ADAT/MADI output.

The OctaMic XTC thus has to be master, all devices connected to it must be slave. In order to avoid clicks and drop outs due to faulty or missing synchronicity, a special process called *Sync-Check* compares the incoming data and the OctaMic XTC internal clock. The sync state is indicated by a flashing (error) or constantly lit (OK) STATE LED.

A selection of Double and Quad Speed is also possible when using external clock (Slave). If the OctaMic XTC should operate at 192 kHz, but receives a synchronous word clock of 48 kHz, set Sample Rate to that value. This way, AD/DA-conversion and digital outputs are configured to operate in the frequency ranges Single Speed, Double Speed or Quad Speed.

Single Speed

All outputs carry a signal in the range of 32 kHz up to 48 kHz.

DS (Double Speed)

The AES outputs 1-8 carry a signal in the range of 64 kHz up to 96 kHz. ADAT and MADI stay at no higher than 48 kHz, with the data transmitted in the S/MUX format.

QS (Quad Speed)

The AES outputs 1-8 carry a signal in the range of 176.4 kHz up to 192 kHz. ADAT and MADI stay at no higher than 48 kHz, with the data transmitted in the S/MUX4 format. Therefore ADAT is limited to 4 channels (2 per optical output) in this mode.

9. The Input Channel in Detail

9.1 Gain

The OctaMic's **GAIN** can be set in steps of 1 dB per channel. Setting the amount of amplification is done digitally, therefore being very accurate and 100% reproducible. The gain change itself is performed within the analog domain.

The range of the adjustable gain is 65 dB. Additionally an attenuator (PAD) of -20 dB is available. The total gain range is therefore 85 dB. The TRS Line input gain range is shifted by about 9 dB. The AD-converter in the OctaMic XTC reaches full scale already at an input level of -53 dBu (Gain 65 dB, XLR input), but also at +32 dBu (Gain 0 dB, PAD active). Therefore the inputs are both sophisticated microphone and line types.

The picture to the right shows levels and gains in an overview and in relation to the different inputs. The instrument input has no PAD, and a gain range of 55 dB.

XLR and TRS Line have a gain range of 55 dB in steps of 1 dB, and another step of 10 dB. Additionally a PAD of -20 dB with XLR and -18 dB with TRS Line is available.

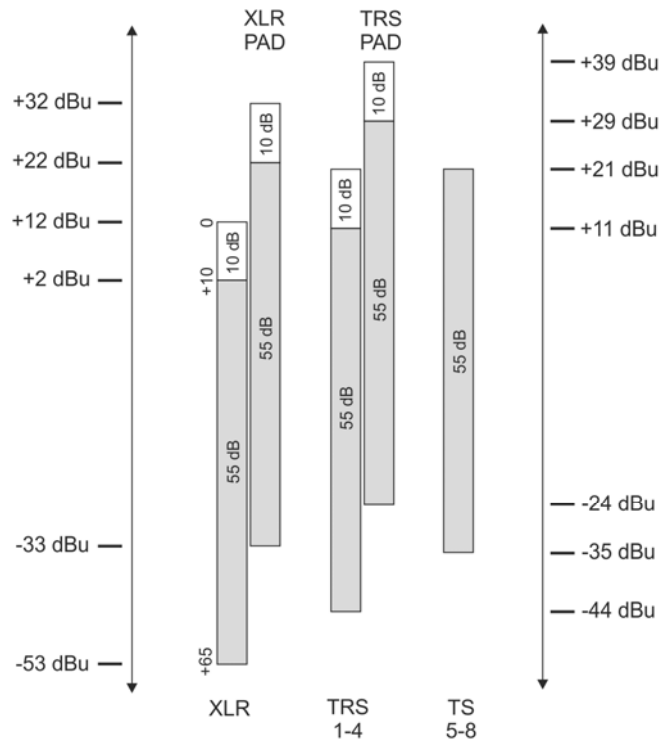

9.2 Phantom Power

The LED **+48V** indicates activated phantom power for the XLR input. Phantom power should only be activated when using condenser microphones which require such a power supply.



Connecting and disconnecting microphones while phantom power is active causes a high voltage surge, which can destroy the microphone input stage! Switch phantom power off before connecting/disconnecting any external device.

The OctaMic XTC turns on the phantom power smoothly during one second, from 0 to 48 Volts. This technique is advantageous for the connected microphone as well as the OctaMic XTC.

The phantom power of the OctaMic XTC is short-circuit proof. With a maximum load on all eight channels the internal voltage from the power supply does not drop below 47 Volts.

9.3 AutoSet

Some preamps include limiters in order to prevent clipping, especially of the A/D converter stage. Such a circuitry is not feasible for the OctaMic XTC, because it would spoil the mic pre-amp's excellent technical data.

But as the OctaMic XTC's gain is controlled completely digitally, the device can set it automatically, thus providing perfect protection from overload with no degradation of the audio signal, which does not have to pass any additional electronic circuits.

Since AutoSet operates as overload protection and not as 'compressor', there is no automatic gain increase. AutoSet only reduces gain. And with AutoSet activated, the gain can still be changed manually. The currently highest possible value can not be exceeded, because AutoSet will reduce the gain in real-time during the manual change.

In practice, there are two possible ways to work with AutoSet:

- Gain of all channels is set to a rather high value, e.g. 60 dB. Then a rehearsal with maximum acoustic level is performed. Thereafter AutoSet is switched off.
- As above, with AutoSet permanently active.

There are good reasons for both of these alternatives. Thanks to the flexible threshold setting and easy manual correction of set values, the OctaMic XTC is fit for all applications.

AutoSet can be activated in CHANNEL as well as on the gain pages brought up by the channel's SELECT key: a push on encoder 1 and 2 activates AutoSet. The label AS in the display changes from light gray to black.

With grouped channels the field **AutoSet Gain** is grayed out, activating AutoSet is then done in the Groups page.

To avoid shifts in panorama AutoSet should work ganged with stereo channels, so that gain changes of one channel are also applied to the other one. This function is part of the groups and thus available for up to 8 channels simultaneously. This also means that for using ganged AutoSet a stereo pair (like Mic1/2) has to be defined and activated as group.

As soon as AutoSet reduces the gain the label AS, shown in the front display, changes its color from black to blue.

9.4 Instrument

The 1/4" TS instrument input of channels 5 to 8 allow to attach both line signals as well as instrument signals. It handles standard line sources like keyboards, mixing desks, effects devices or consumer-type units perfectly well. With its input impedance of 800 kOhm it also serves perfectly as instrument input. The maximum input level is +21 dBu unbalanced. PAD is not available here.

10. Using Multiple Units with MADI

Devices like the OctaMic XTC can be connected serially via MADI, and then transmit up to 64 channels (with up to 8 XTC) over one single MADI cable. In the menu *Digital Routing* the user can decide at which place of the 64-channel MADI stream the current eight channels of the XTC are inserted.

When multiple devices are connected serially, the MADI I/O of each unit causes a delay of several samples. This problem is solved by the function *Delay Compensation*. Its settings are found in SETUP – Options – MADI Settings.

10.1 Delay Compensation

Default: Off. Available settings: Off, Manual, Auto-ID, Auto-CA

When multiple devices are connected serially, the MADI I/O of each OctaMic XTC causes a delay of 3 samples. Therefore at the MADI output of the last device, the data of all upstreamed devices are delayed. At Double Speed the delay rises to 6 samples per unit, at Quad Speed to 12 samples.

Delay Compensation delays the signals in a way that they are sample-synchronous in multi-device operation.



Delay Compensation has to be manually activated in each unit!

The following table lists the delay in samples from two up to eight units connected serially. When using four units, the data of the first unit are delayed by 9 samples to the last unit, the units 2 and 3 are delayed by 6 and 3 samples respectively. At Double Speed and Quad Speed the values rise. Please note that in Double Speed no more than four, in Quad Speed no more than two OctaMic XTC can be used serially with MADI.

Units	Delay	Delay DS	Delay QS	DC	DC DS	DC QS
2	3	6	12	21	18	12
3	6	12	-	21	18	-
4	9	18	-	21	18	-
5	12	-	-	21	-	-
6	15	-	-	21	-	-
7	18	-	-	21	-	-
8	21	-	-	21	-	-

21 samples @ 48 kHz
equal 437 µs.

18 samples @ 96 kHz
equal 187 µs.

12 samples @ 192
kHz equal 62.5 µs.

Inputs and outputs are delayed in different ways. With the inputs the delay equals the values shown in the table. When using multiple units in serial cabling, the input data of the second unit is delayed by 3 samples, the input data of the third by 6 samples and so on. This way, at the end of the chain all input data are sample-aligned again. Chapter 13.3 shows a diagram to illustrate the setup.

The XTC's Delay Compensation affects not only the analog inputs, but the digital ones as well. For example additional AD-converters connected to the ADAT inputs and inserted into the MADI stream – all the converters analog inputs fed to multiple XTCs will be sample-aligned again.

Even the analog outputs of the XTC use the Delay Compensation. For technical reasons here the delay is a fixed constant of 21 samples in Single Speed, no matter how many devices are connected serially. In Double Speed the delay is 18, in Quad Speed 12 samples. The in most cases slightly increased delay is outweighed by the big advantage of sample-aligned analog outputs across multiple units.

Manual

With this setting active, the user has to enter the *Compens. ID* (Compensation ID) manually. The value must equal the position of the device within the chain.

Auto-ID

OctaMic XTC detects other devices sitting in front of it within the chain. If none is detected the ID is set to 1, else according to the found ID plus 1. The entry *Compens. ID* is grayed out, because no longer manually adjustable.

Auto-CA

The option Auto Channel Assignment sets the digital routing according to the current ID. For example the third OctaMic XTC in a chain will automatically use channels 17-24 in the MADi data stream.

This is the most comfortable, fastest and safest way to use several devices serially. Simply set *Delay Comp.* in all units to Auto-CA, quickly check the IDs in the display, and you're ready to enjoy all channels within just one MADi cable and sample-aligned.

10.2 Compensation ID

Default: 1. Available settings: 1, 2, 3, 4, 5, 6, 7, 8

In Auto-CA mode, the ID defines the 8-channel group within the MADi signal that is used to insert the device's audio data:

ID 1: channels 1-8	ID 2: channels 9-16	ID 3: channels 17-24
ID 4: channels 25-32	ID 5: channels 33-40	ID 6: channels 41-48
ID 7: channels 49-56	ID 8: channels 57-64	

When several OctaMic XTC, ADI8-QS or ADI-642 units are connected via MADi, Auto-ID helps to set up all units correctly. In special cases, it may be desirable to set the ID manually, e.g. if the first device in a MADi chain does not support the Auto-ID mode, or if a group of eight channels needs to be routed or processed in a particular way.

11. Remote Control

11.1 MIDI

The OctaMic XTC can be completely remote controlled via MIDI. It reacts on special SysEx commands. Furthermore, upon request it will report the complete device status. Each OctaMic XTC can be programmed with its own ID (menu *Options - General Settings*), providing a separated remote control of multiple devices via a single MIDI channel. A description of the MIDI implementation is found in chapter 24.

The menu *Options – MIDI Sources* is used to define from which port the XTC receives MIDI remote control commands: USB1, USB2, MADI In or DIN In. The option OFF is a safety setting to prevent unexpected changes by MIDI signals.

In the same menu the output for the unit's response to external remote commands is chosen. All MIDI ports of the XTC, USB 1/2, DIN and MADI, are available as Control output, even at the same time.

In the menu *General Settings* it is even possible to activate a through-mode of the complete MIDI signal from the Control input to the Control output port. This option is especially useful with serial MADI cabling, as remote commands would otherwise get stuck already at the first unit within the MADI chain.

11.2 MIDI over MADI

MADI allows for a transmission of 64 audio channels over long distances with a single line – perfect. But what about MIDI? Be it remote control commands or sequencer data, in practice only a single MADI line will not suffice. Therefore RME developed the *MIDI over MADI* technology. The data at the MIDI input are being included into the MADI signal invisibly, and can be collected at the MIDI output of another OctaMic XTC or other RME MADI device at the other end of the MADI line.

Technically every single MADI channel includes several additional bits, containing various information (Channel Status). RME use the usually unused *User bit* of channel 56 (channel 28 in 96k frame mode), to transmit MIDI data invisibly within MADI, ensuring full compatibility.

To remote control more than one OctaMic XTC every unit can have its own ID (menu *Options - General Settings*), providing a separated remote control of multiple devices via a single MIDI channel.

11.3 Control via TotalMix FX

Every RME audio interface equipped with TotalMix FX (> v0.99) includes an option to control the OctaMic XTC's most important parameters (gain, 48V, phase, mute, AutoSet) from the TotalMix FX input channels. This special remote control uses MIDI (DIN, USB, MIDI over MADI).

In TotalMix FX go to *Options – Settings - Aux Devices*. Select the OctaMic XTC, the audio path (ADAT or MADI) and the Device ID (default: 0). In the channel settings panel new elements appear (for example a Gain knob in an ADAT channel).

At the OctaMic XTC *Control* has to be selected in the menu SETUP – Options – MIDI Sources to the currently used MIDI input and output. Set Control (Inp.) to DIN In, MIDI DIN Out to Control.

MADI interfaces do not need additional MIDI cabling. They can use the virtual MIDI port (MIDI over MADI) instead.

User's Guide



OctaMic XTC

► Inputs and Outputs

12. Analog Inputs / Outputs

12.1 Mic / Line In (XLR)

The OctaMic XTC has 8 balanced full range XLR inputs on the back panel. The electronic input stage is built in a servo balanced design which handles unbalanced and balanced signals correctly, automatically adjusting the level reference.



When using unbalanced cables be sure to connect pin 3 (-) to 1 (ground). Otherwise noise may occur, caused by the unconnected negative input of the balanced input.

The pin assignment follows international standards. With XLR, pin 2 is + or hot, pin 3 is – or cold, pin 1 is ground. Pin 1 is connected to the chassis directly at the socket (AES48).

The OctaMic XTC offers an adjustable amplification from -20 dB up to +65 dB. This equals a sensitivity of +32 dBu down to -53 dBu, referenced to full scale of the AD-converter. Changing the gain is usually done click-free, as the gain change is performed during the zero crossing of the audio signal, if possible.

The soft switching, hi-current phantom power (48 Volt) provides a professional handling of condenser microphones. The usage of a hi-end integrated circuit (PGA 2500) plus a fully symmetrical signal path guarantees outstanding sound quality, stunning low THD, and maximum Signal to Noise ratio in any gain setting.

Due to the XTC's flexibility, its signal to noise ratio is not easy to determine. The EIN value is constant across a very wide amplification range, typically 127 dBu at 150 Ohm input impedance. Even at a gain setting of 30, which corresponds to 0 dBFS at only -18 dBu, the EIN still reaches 122 dBu.

12.2 Line In (TRS)

TRS sockets of inputs 1-4 operate as line inputs. Compared to the XLR inputs they have slightly higher input impedance (6.6 kOhm) and a fixed attenuation of 9 dB. This has no influence on noise or distortion. Even the adjustable gain range is still 65 dB. But the PAD attenuates only by 18 dB, so that the input sensitivity covers +39 dBu down to -44 dBu, referenced to full scale of the AD-converter.

12.3 Instrument In

The main difference between a line and an instrument input is its input impedance. Channels 5-8 offer an input impedance of 800 kOhm at the TS socket, with adjustable gain from +10 dB up to +65 dB. This equals a sensitivity of +21 dBu down to -34 dBu, referenced to full scale of the AD-converter.

12.4 Phones / Line Out

The OctaMic XTC has two unbalanced stereo 1/4" TRS outputs on the front. They are also special low impedance types, ready to be used with headphones. These channels are driven from a high-quality DA-converter with 118 dBA Signal to Noise ratio. Additionally two hardware-based reference levels are available. In the menu CHANNEL – *Phones 1/2* the output level can be chosen between High and Low. High equals an output level of +17 dBu at 0 dBFS, Low a level of +4 dBV (+4.2 dBu). They can thus also be used as high-quality (yet unbalanced) line outputs.

Setting the output level, i.e. the monitoring volume, is done directly by turning the encoder knob 1 (Phones channel 1/2) and 2 (Phones channel 3/4). Changing the monitoring volume is therefore very easy and quickly done.

In case the outputs should operate as Line outputs, an adapter TRS plug to RCA phono plugs, or TRS plug to TS plugs is required.

The pin assignment follows international standards. The left channel is connected to the tip, the right channel to the ring of the TRS jack/plug.

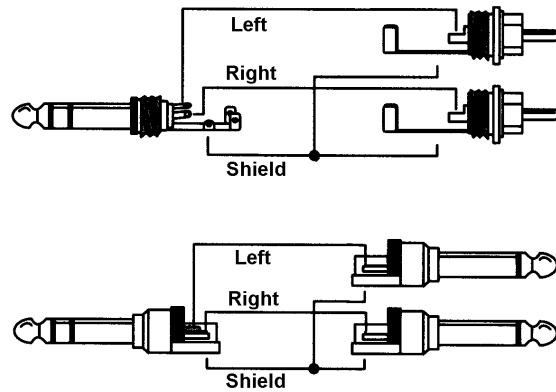

13. Digital Inputs and Outputs

13.1 AES/EBU

The four AES/EBU inputs and outputs are provided on the rear of the OctaMic XTC via a 25 pin D-sub connector with Tascam pinout. A digital breakout cable will provide 4 male and 4 female XLR connectors. Every input and output is transformer-balanced, ground-free and compatible to all devices with AES/EBU ports.

In normal operation the AES outputs carry the converted analog input signal. Via the menu *Digital Routing* also ADAT, USB, MADI and even AES can be chosen as source.

Besides the audio data, digital signals in SPDIF or AES/EBU format contain a channel status coding, which is being used for transmitting further information. The output signal coding of the OctaMic XTC has been implemented according to AES3-1992 Amendment 4:

- 32 kHz, 44.1 kHz, 48 kHz, 64 kHz, 88.2 kHz, 96 kHz, 176.4 kHz, 192 kHz according to the current sample rate
- Audio use
- No Copyright, Copy permitted
- Format Professional
- Category General, Generation not indicated
- 2-Channel, No Emphasis
- Aux bits audio use, 24 bit
- Origin: HDSP

Connecting devices with coaxial SPDIF ports to the OctaMic XTC outputs is accomplished by simple cable adapters XLR/RCA. To achieve this, pins 2 and 3 of an XLR plug are being connected to the two contacts of a Phono/RCA plug. The ground shield of the cable is only connected to pin 1 of the XLR plug.

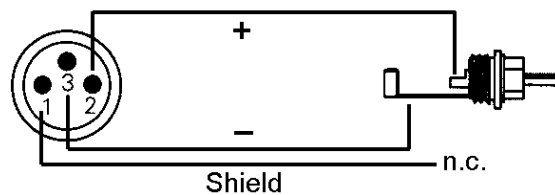

 *Note that most consumer HiFi equipment with phono (SPDIF) inputs will only accept signals with Channel Status 'Consumer'! In such cases the above adapter cable will not work.*

The OctaMic XTC supports Single Wire only, in the range of 32 kHz up to 192 kHz: a total of 8 channels, 2 channels per AES wire. The effective sample frequency equals the clock on the AES wire. In case a conversion from/to Single, Double and Quad Wire is required, the RME ADI-192 DD, an 8-channel universal sample rate and format converter, is highly recommended.

Pinout of the D-sub connector, Outputs

Signal	Out 1/2+	Out 1/2-	Out 3/4+	Out 3/4-	Out 5/6+	Out 5/6-	Out 7/8+	Out 7/8-
D-Sub	18	6	4	17	15	3	1	14

GND is connected to pins 2, 5, 8, 11, 16, 19, 22, 25. Pin 13 is not connected.

The input AES 1 to 4 (channel 1-8) found on the D-sub connector can be used for audio (*Digital Routing*) but also as clock source. Thanks to a highly sensitive input stage, a SPDIF signal can also be fed by using a simple cable adapter phono/XLR (see above).

Pinout of the D-sub connector, Inputs

Signal	In 1/2+	In 1/2-	In 3/4+	In 3/4-	In 5/6+	In 5/6-	In 7/8+	In 7/8-
D-sub	24	12	10	23	21	9	7	20

13.2 ADAT Optical

The OctaMic XTC provides two digital outputs in ADAT optical format. In normal operation these ports carry the converted analog input signal. Via the menu *Digital Routing* also AES, USB, MADi and even ADAT can be chosen as source.

In Single Speed mode both outputs can carry the same audio data, when set up accordingly in Digital Routing. With this it is possible to distribute the output signal to two different devices.

When operating with sample rates higher than 48 kHz the entry ADAT 2 in the menu Digital Routing will be grayed out. The OctaMic XTC then is in S/MUX mode, and will send the source signal selected for ADAT 1 also at the ADAT 2 port.

As the ADAT optical signal is physically specified up to 48 kHz only, the OctaMic XTC automatically activates Sample Split mode (S/MUX) at 88.2 and 96 kHz, distributing the data of one channel to two output channels. The internal frequency stays at 44.1/48 kHz. Therefore the sample clock at the ADAT outputs is only half the frequency of the AES outputs. As interesting as this is – you don't need to think about it. 96 and 192 kHz capable ADAT hardware, like all current RME digital interfaces, re-combine the data automatically. The user (and the DAW software) does not see any split data, but just single channels at the expected double sample rate.

The ADAT outputs can be used at up to 192 kHz, but in QS mode only channels 1 to 4 will be available.

The ADAT optical outputs of the OctaMic XTC are fully compatible to all ADAT optical inputs. A usual TOSLINK cable is sufficient for connection.

ADAT Main

Interface for the first or only device receiving an ADAT signal from the OctaMic XTC. Carries the channels 1 to 8. When sending a Double Speed signal, this port carries the channels 1 to 4. In Quad Speed mode this port carries channels 1 and 2.

ADAT AUX

In Single Speed mode carries the source signal set for ADAT 2 in *Digital Routing*. When sending a Double Speed signal, this port carries the channels 5 to 8 of the source signal set for ADAT 1. In Quad Speed mode this port carries the channels 3 and 4 of the source signal set for ADAT 1.

13.3 MADI

The optical MADI I/O provides the OctaMic XTC with a 64-channel MADI input and output. The menu *Digital Routing* determines on which channels the XTC transmits its data (see chapter 8.5.1).

The MADI input will operate as an optional clock source (menu *Clock*) as well as a through input. Since each OctaMic XTC uses only 8 channels, up to 56 channels can be passed through, switching this function off even all 64.

This technique is used to serially cascade several OctaMic XTC. Incoming MADI data is passed through unchanged, only one block of eight channels is replaced. This allows up to 8 devices to be connected serially. All 64 combined channels are available at the last device's output. The the block of eight channels used by an individual device is determined either automatically (Auto-CA) or manually (Compens. ID) in the menu *MADI Settings*:

ID 1: channels 1-8	ID 2: channels 9-16	ID 3: channels 17-24
ID 4: channels 25-32	ID 5: channels 33-40	ID 6: channels 41-48
ID 7: channels 49-56	ID 8: channels 57-64	

The configuration of the MADI output signal is also done in the *MADI Settings* menu. **MADI Format** sets the format to 56 or 64 channels. **MADI Frame** sets the format to 48k Frame or 96k Frame when operating at 88.2 and 96 kHz. Sample rates higher than 48 kHz can be transmitted with the standard 48k Frame as well, but then there is no automatic detection of the real sample rate. This is the main advantage of the 96k Frame, but not all MADI devices support that format.

The OctaMic XTC can also be remote controlled via MADI. At the same time MIDI data are transmitted via MADI, see chapter 11.2.

When multiple devices are connected serially, the MADI I/O of each OctaMic XTC causes a delay of 3 samples. Therefore at the MADI output of the last device, the data of all upstreamed devices are delayed. At Double Speed the delay rises to 6 samples per unit, at Quad Speed to 12 samples.

The problem of this offset is solved by the function *Delay Compensation*, see chapter 10.1. It delays the signals in a way that they are sample-synchronous in multi-device operation. The diagram on the next page shows a serial setup with HDSPe MADI card, three OctaMic XTC and activated Delay Compensation with automatic channel assignment (Auto-CA).



Delay Compensation has to be manually activated in each unit!

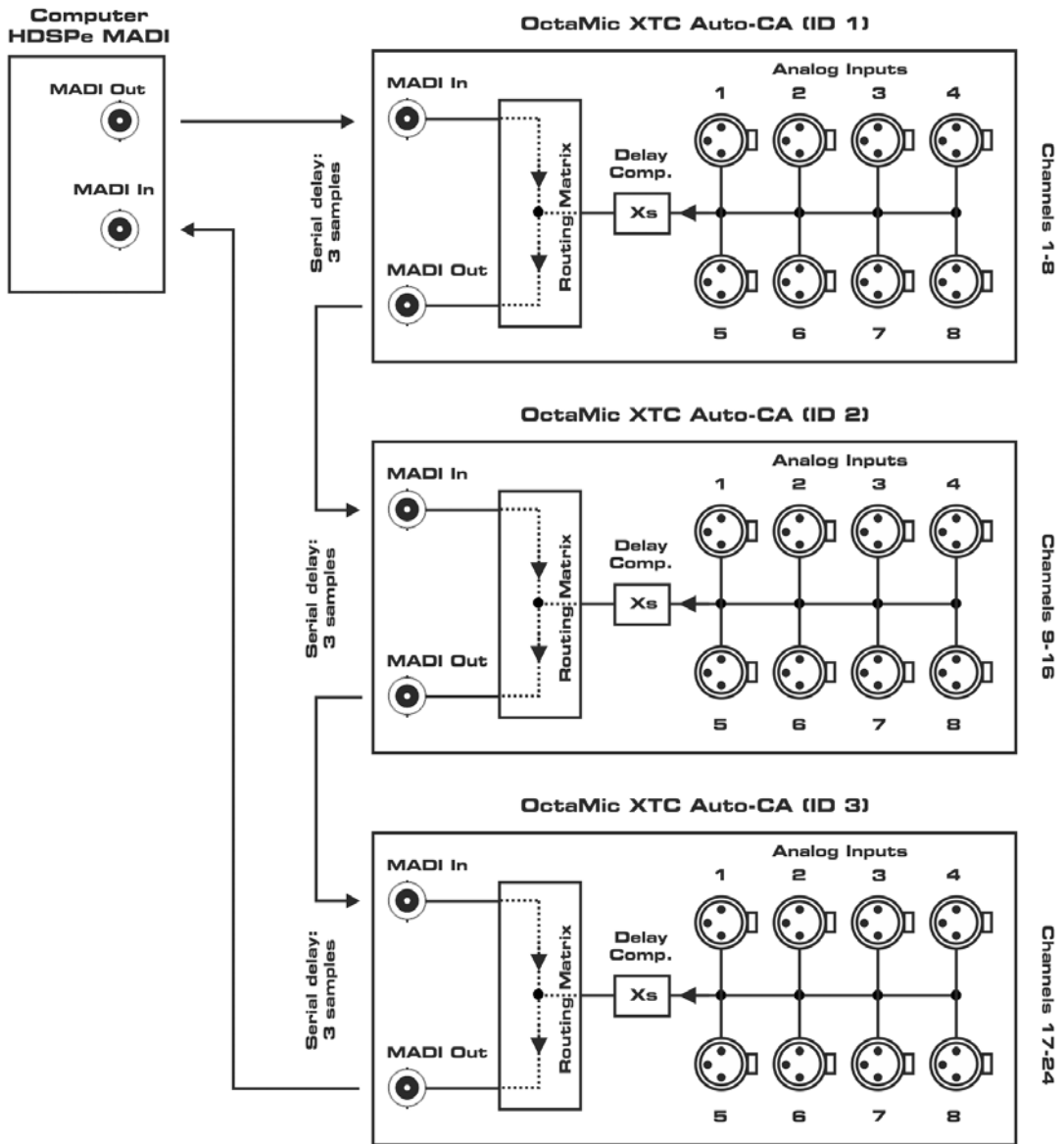

14. Word Clock

14.1 Word Clock Input and Output

SteadyClock guarantees an excellent performance in all clock modes. Its highly efficient jitter suppression refreshes and cleans up any clock signal, and provides it as reference clock at the BNC output (see section 18.10).

Input

The OctaMic XTC word clock input is active when WCK is chosen in the clock section. The signal at the BNC input can be Single, Double or Quad Speed, the OctaMic XTC automatically adapts to it. As soon as a valid signal is detected, the WCK LED is constantly lit, otherwise it is flashing.

Thanks to RME's *Signal Adaptation Circuit*, the word clock input still works correctly even with heavily mis-shaped, dc-prone, too small or overshoot-prone signals. Thanks to automatic signal centering, 300 mV (0.3V) input level is sufficient in principle. An additional hysteresis reduces sensitivity to 1.0 V, so that over- and undershoots and high frequency disturbances don't cause a wrong trigger.

The word clock input is shipped as high impedance type (not terminated). The menu *Clock - WCK Term.* has an option to activate internal termination with 75 Ohms.

Output

The OctaMic XTC's word clock output is constantly active, providing the current sample frequency as word clock signal. In master mode, the word clock will be fixed to 44.1 kHz or 48 kHz (DS x 2, QS x 4). In any other case the sample rate is identical to the one present at the currently chosen clock input. When the current word clock source fails, the last valid sample rate will be held automatically.

Selecting the option *WCK Alw. Singl* in the menu *Clock* causes the word clock output to always stay within the range of 32 kHz to 48 kHz. So at 96 kHz and 192 kHz sample rate, the output word clock is 48 kHz.

The word clock signal received by the OctaMic XTC can be distributed to other devices by using the word clock output. With this the usual T-adaptor can be avoided, and the OctaMic XTC operates as *Signal Refresher*. This kind of operation is highly recommended, because

- Input and output are phase-locked and in phase (0°) to each other
- *SteadyClock* removes nearly all jitter from the input signal
- the exceptional input (1 Vpp sensitivity instead of the usual 2.5 Vpp, dc cut, *Signal Adaptation Circuit*) plus *SteadyClock* guarantee a secure function also with most critical word clock signals.

Thanks to a low impedance, but short circuit proof output, the OctaMic XTC delivers 4 Vpp to 75 Ohms. For wrong termination with 2 x 75 Ohms (37.5 Ohms), there are still 3.3 Vpp at the output.

14.2 Operation and Technical Background

In the analog domain one can connect any device to another device, synchronization is not necessary. Digital audio is different. It uses a clock, the sample frequency. The signal can only be processed and transmitted when all participating devices share the same clock. If not, the signal will suffer from wrong samples, distortion, crackle sounds and drop outs.

AES/EBU, SPDIF, ADAT and MADI are self-clocking, an additional word clock connection in principle isn't necessary. But when using more than one device simultaneously problems are likely to happen. For example any self-clocking will not work in a loop cabling, when there is no 'master' (main clock) inside the loop. Additionally the clock of all participating devices has to be synchronous. This is often impossible with devices limited to playback, for example CD players, as these have no SPDIF input, thus can't use the self clocking technique as clock reference.

In a digital studio synchronisation is maintained by connecting all devices to a central sync source. For example the mixing desk works as master and sends a reference signal, the word clock, to all other devices. Of course this will only work as long as all other devices are equipped with a word clock or sync input, thus being able to work as slave (some professional CD players indeed have a word clock input). Then all devices get the same clock and will work in every possible combination with each other.



Remember that a digital system can only have one master! If the OctaMic XTC uses its internal clock, all other devices must be set to 'Slave' mode.

But word clock is not only the 'great problem solver', it also has some disadvantages. The word clock is based on a fraction of the really needed clock. For example SPDIF: 44.1 kHz word clock (a simple square wave signal) has to be multiplied by 256 inside the device using a special PLL (to about 11.2 MHz). This signal then replaces the one from the quartz crystal. Big disadvantage: because of the high multiplication factor the reconstructed clock will have great deviations called jitter. The jitter of a word clock is much higher as when using a quartz based clock.

The end of these problems should have been the so called Superclock, which uses 256 times the word clock frequency. This equals the internal quartz frequency, so no PLL for multiplying is needed and the clock can be used directly. But reality was different, the Superclock proved to be much more critical than word clock. A square wave signal of 11 MHz distributed to several devices - this simply means to fight with high frequency technology. Reflections, cable quality, capacitive loads - at 44.1 kHz these factors may be ignored, at 11 MHz they are the end of the clock network. Additionally it was found that a PLL not only generates jitter, but also rejects disturbances. The slow PLL works like a filter for induced and modulated frequencies above several kHz. As the Superclock is used without any filtering such a kind of jitter and noise suppression is missing.

The actual end of these problems is offered by the **SteadyClock** technology of the OctaMic XTC. Combining the advantages of modern and fastest digital technology with analog filter techniques, re-gaining a low jitter clock signal of 22 MHz from a slow word clock of 44.1 kHz is no problem anymore. Additionally, jitter on the input signal is highly rejected, so that even in real world usage the re-gained clock signal is of highest quality.

14.3 Cabling and Termination

Word clock signals are usually distributed in the form of a network, split with BNC T-adapters and terminated with resistors. We recommend using off-the-shelf BNC cables to connect all devices, as this type of cable is used for most computer networks. Actually you will find all the necessary components (T-adapters, terminators, cables) in most electronics and computer stores. The latter usually carries 50 Ohm components. The 75 Ohm components used for word clock are part of video technology (RG59).

Ideally, the word clock signal is a 5 Volt square wave with the frequency of the sample rate, of which the harmonics go up to far above 500 kHz. To avoid voltage loss and reflections, both the cable itself and the terminating resistor at the end of the chain should have an impedance of 75 Ohm. If the voltage is too low, synchronization will fail. High frequency reflection effects can cause both jitter and sync failure.

Unfortunately there are still many devices on the market, even newer digital mixing consoles, which are supplied with a word clock output that can only be called unsatisfactory. If the output breaks down to 3 Volts when terminating with 75 Ohms, you have to take into account that a device, of which the input only works from 2.8 Volts and above, does not function correctly already after 3 meter cable length. So it is not astonishing that because of the higher voltage, word clock networks are in some cases more stable and reliable if cables are not terminated at all.

Ideally all outputs of word clock delivering devices are designed as low impedance types, but all word clock inputs as high impedance types, in order to not weaken the signal on the chain. But there are also negative examples, when the 75 Ohms are built into the device and cannot be switched off. In this case the network load is often 2 x 75 Ohms, and the user is forced to buy a special word clock distributor. Note that such a device is generally recommended for larger studios.

The OctaMic XTC's word clock input can be high-impedance or terminated internally, ensuring maximum flexibility. If termination is necessary (e.g. because the OctaMic XTC is the last device in the chain), activate the option *WCK Term.* in the menu *Clock*.

In case the OctaMic XTC resides within a chain of devices receiving word clock, plug a T-adapter into its BNC input jack, and the cable supplying the word clock signal to one end of the adapter. Connect the free end to the next device in the chain via a further BNC cable. The last device in the chain should be terminated using another T-adapter and a 75 Ohm resistor (available as short BNC plug). Of course devices with internal termination do not need T-adapter and terminator plug.



Due to the outstanding SteadyClock technology of the OctaMic XTC, we recommend to not pass the input signal via T-adapter, but to use the OctaMic XTC's word clock output instead. Thanks to SteadyClock, the input signal will both be freed from jitter and - in case of loss or drop out – be held at the last valid frequency.

15. MIDI

The OctaMic XTC has a standard MIDI input and output, a 5-pin DIN jack each. The MIDI I/O is used for:

- remote control of the OctaMic XTC, see chapter 11.1
- transmission of MIDI data and remote control commands over MADi and USB.

User's Guide



OctaMic XTC

▶ Class Compliant Mode

16. General

The USB port of the OctaMic XTC provides two functions:

- Firmware update under Windows and Mac OS X (also see chapter 21.7)
- Usage as audio interface under Mac OS X and with Apple's iPad®

As Windows does not support Class Compliant mode with USB 2.0 directly, special support for the OctaMic XTC has to be installed first. This is done with the RME Driver Installer for MADIface XT, MADIface USB and OctaMic XTC (Firmware Enabler). After that the XTC firmware update tool can update the firmware to the latest version. Both tools are found on the RME website (www.rme-audio.de) in the section Downloads.

Under Mac OS X no preparation is required, the firmware updater is fully operational as soon as a OctaMic XTC is connected via USB.

Thanks to native support of the Class Compliant mode the OctaMic XTC operates under Mac OS X like an audio interface. It provides 24 channels of I/O, see chapter 18.2

Exciting as well as useful is the usage of the OctaMic XTC as hardware frontend for Apple's iPad. The XTC provides the iPad with the professional analog I/O connections it lacks: Superb microphone preamps with AutoSet, professional balanced line inputs, instrument inputs, 2 hi-power headphone outputs, and all common digital interface ports - ADAT, AES and MADI. All this can be used with up to 24 channels in and out simultaneously. Everything is available fully digital via USB, in uncompromised quality with up to 192 kHz and 24-bit. And of course a Sysex-capable double MIDI I/O.

Note that since iOS 5 multichannel recording is supported, and since iOS 6 multichannel playback as well. At this time only **djay** and **Auria** support more than one stereo output, others are expected to follow soon.

17. System requirements

- Apple computer with OS 10.6 or higher
- Any Apple iPad with at least iOS 5. iPhone and iPod Touch can not be used.
- Apple iPad Camera Connection Kit (Dock or Lightning to USB)

18. Operation

Mac Computer: Connect the XTC to the Apple Computer via USB. In the system tool Sound and the Audio MIDI window the OctaMic XTC is now shown and can be used as record and playback device.

iPad: Connect the USB cable to the XTC and the Camera Connection Kit. Start the iPad and plug the Camera Connection Kit into the Dock connector. Audio playback in iTunes now automatically switches to the XTC. Use the XTC's *Digital Routing* screen to assign record and playback channels to the analog and digital I/Os of the XTC.

Apps that support MIDI and are ready for Core MIDI (available since iOS 4.2) will offer dialogs to select the desired XTC MIDI inputs and outputs.

18.1 Useful hints

When using hard covers as back panel protection for the iPad, the Connection Kit's plug may not fit completely, causing a loose connection or partial functionality. If in doubt, remove the cover.

No sound: Incorrect output gain settings, see chapter 8.5.1.

The iPad's volume control is inactive during USB operation!

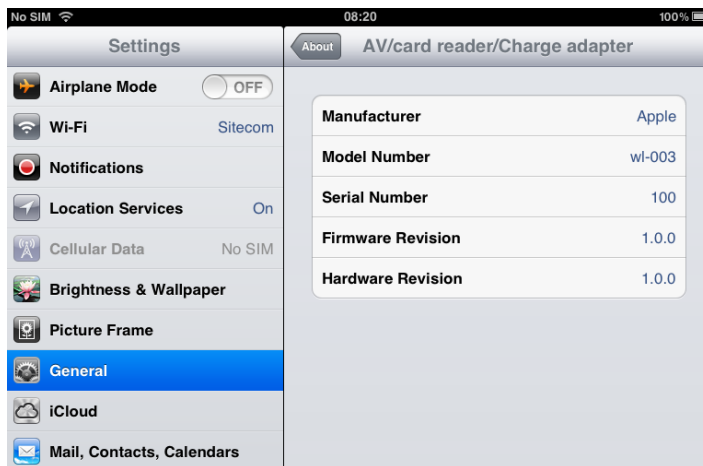

If the XTC is not recognized: Remove and reconnect the Connection Kit.

Correct detection and operation of the Connection Kit itself can be determined in Settings / General / About. The adapter will be listed there right after connection, with additional details like manufacturer, model number etc. Connected USB devices, i.e. the XTC will not be shown here, though.

 *Having tested several chinese replicas of the Apple Camera Connection Kit, from 2-in-1 to 5-in-1 adapters, we strongly recommend purchasing the original for use with the XTC!*

All adapters seemed to work for the simple application of copying photos. Attempting to run the XTC with USB Audio 2.0 was when the problems started. Some of the tested adapters would not work at all, others only with short cables, and only one adapter came close to the quality of the original. But as soon as 8-channel recording or 96 kHz playback was initiated, the Apple Kit always performed much better.

 *We also recommend the purchase of a dock-to-dock extension cable, to avoid having the CCK attached to the iPad directly with the heavy USB cable hanging down.*

This can cause the CCK to slip out of the iPad's connector, or to be in the way most of the time. An extension cable provides enormous freedom of movement. We are working with cable lengths of 50 cm and 1 m, both work flawlessly. These cables are available as *DeLock iPhone extension cable*, or *Dock Extender*, e.g. from Amazon.

It is important to note that each individual component is responsible for stable operation of XTC and iPad. As an example, a setup with an iPad connected to a 1 m DeLock cable, CCK, 5 m USB connection to the XTC only worked with the original Apple CCK. Not only for simple iTunes stereo playback, but also with 96 kHz playback and 8-channel recording. In this setup, the USB cable could even be replaced with a 10 m active one. With lower quality cables or CCK replicas, even 50 cm dock to dock to 1 m USB would be considered success...

18.2 Class Compliant Mode under Windows and Mac OS X

Windows does not support USB Audio 2.0 directly. The XTC will be detected, but automatic driver installation will fail. After installation of the special driver for the firmware updates (Firmware Enabler) the XTC will be listed as normal audio device, but is not available for WDM or ASIO operation.

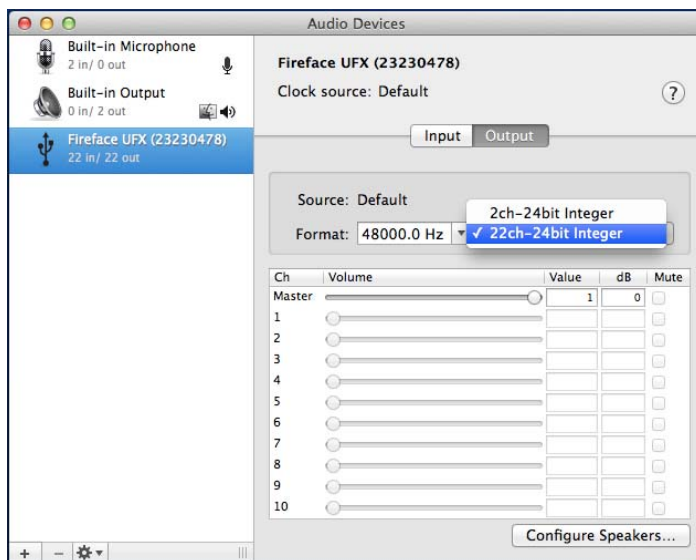
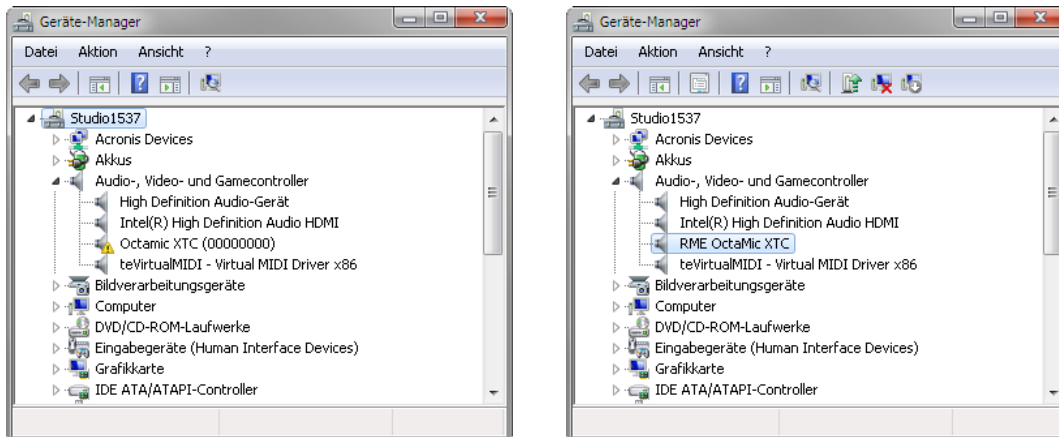

Mac OS X supports USB Audio 2.0, even with more than 2 channels.

The XTC offers 24 input and 24 output channels at up to 96 kHz, but can also be used in a resource saving 8-channel mode with up to 192 kHz.

Alsa (Linux) does not work with USB 2 Class Compliant interfaces at this time, but it seems it can be fixed (recompiled) to do so. More information is available here:

<http://www.mail-archive.com/alsa-user@lists.sourceforge.net/msg28901.html>

19. Supported Inputs and Outputs

In Mac OS X, either 8 or 24 channels are active, depending on the choice in the Audio MIDI Setup. In both cases the playback signal of channels 1/2 can be copied to other outputs.

When connected to an iPad, the analog mic/line input 1 works with mono apps, inputs 1 and 2 with stereo apps (both dual mono and stereo), and up to 8 inputs with 8-channel applications like *MultiTrack DAW* and *Music Studio*. *Garage Band* supports all inputs, but only two at a time. *Auria* can record all 24 inputs simultaneously.

In playback operation the XTC can optionally route the iPad playback channels 1/2 to outputs Phones 1, Phones 2, ADAT, AES and MADI (menu *Digital Routing*).

In slave mode (with external clock) the XTC (and with it the iPad) will be synchronized to an external digital sample rate if there is a valid digital input signal. With a wrong sample rate heavy audio noise will occur. Without any digital input signal the XTC stays in master mode. The current sample rate is the one set by Mac OS X or iOS (the app in use).

While the MIDI I/Os will send and receive Sysex messages, not all apps are ready to do this. For example *MIDI Monitor* and *AC-7* do not support Sysex at this time. The app *Midi Tool Box* can be used to verify that the XTC is working correctly, and the problem lies somewhere else.

20. Operation at the Unit

The front panel operation in Class Compliant mode is unchanged. Only the choice of sample rate is taken over by the computer/iPad.



User's Guide



OctaMic XTC

▶ **Technical Reference**

21. Technical Specifications

21.1 Analog

Microphone 1-8

- Input: XLR, electronically balanced
- Input impedance: 2.4 kOhm, PAD 3.5 kOhm
- Gain range: 0, +10 dB up to +65 dB in steps of 1 dB
- PAD: -20 dB
- THD @ 30 dB Gain: < -110 dB, < 0.0003 %
- THD+N @ 30 dB Gain: < -100 dB, < 0.001 %
- CMRR 50 Hz: > 60 dB
- CMRR 200 Hz – 20 kHz: > 70 dB
- Maximum input level, Gain 0 dB: +12 dBu
- Maximum input level, Gain 0 dB with PAD: +32 dBu
- Maximum input level, Gain 65 dB: -53 dBu
- Signal to Noise ratio (SNR) @ Gain 10 dB: 113 dB RMS unweighted, 117 dBA

Line TRS In 1-4

- Input: 6.3 mm TRS jack, electronically balanced
- Input impedance: 3.3 kOhm unbalanced, 6.6 kOhm balanced
- Input impedance with PAD: 3.8 kOhm unbalanced, 7.7 kOhm balanced
- Gain range: 0, +10 dB up to +65 dB in steps of 1 dB
- PAD: -18 dB
- Maximum input level, Gain 0 dB: +21 dBu
- Maximum input level, Gain 0 dB with PAD: +39 dBu
- Maximum input level, Gain 65 dB: -44 dBu
- Signal to Noise ratio (SNR) @ Gain 10 dB: 113 dB RMS unweighted, 117 dBA

Inst TRS In 5-8

- Input: 6.3 mm TS jack, unbalanced
- Input impedance: 800 kOhm (Hi-Z)
- Gain range: +10 dB up to +65 dB in steps of 1 dB
- Maximum input level, Gain 10 dB: +21 dBu
- Maximum input level, Gain 65 dB: -34 dBu
- Signal to Noise ratio (SNR) @ Gain 10 dB: 112 dB RMS unweighted, 115 dBA

Line/Phones Out 1-4

- Resolution: 24 Bit
- Noise (DR): 115 dB RMS unweighted, 118 dBA
- Frequency response @ 44.1 kHz, -0.5 dB: 9 Hz – 22 kHz
- Frequency response @ 96 kHz, -0.5 dB: 9 Hz – 45 kHz
- Frequency response @ 192 kHz, -1 dB: 8 Hz - 75 kHz
- THD+N: < -100 dB, < 0.001 %
- Channel separation: > 110 dB
- Output: 6.3 mm TRS stereo jack, unbalanced
- Maximum output level at 0 dBFS, High: +17 dBu
- Maximum output level at 0 dBFS, Low: +2 dBV
- Output impedance: 30 Ohm

AD-Conversion General

- Resolution: 24 Bit

AD-Conversion Mic XLR

- Frequency response @ 44.1 kHz, -0.5 dB: 12 Hz – 20.8 kHz
- Frequency response @ 96 kHz, -0.5 dB: 12 Hz – 45.3 kHz
- Frequency response @ 192 kHz, -1 dB: 8 Hz - 94 kHz
- THD+N: < -100 dB, < 0.001 %
- Channel separation: > 110 dB
- Signal to Noise ratio depends on current gain setting

AD-Conversion Line/Inst TRS

- Frequency response @ 44.1 kHz, -0.5 dB: 10 Hz – 20.8 kHz
- Frequency response @ 96 kHz, -0.5 dB: 10 Hz – 45.3 kHz
- Frequency response @ 192 kHz, -1 dB: 5 Hz - 90 kHz

21.2 Digital Inputs

AES/EBU

- 1 x 25-pin D-sub, transformer-balanced, galvanically isolated, according to AES3-1992
- High-sensitivity input stage (< 0.3 Vpp)
- SPDIF compatible (IEC 60958)
- Accepts Consumer and Professional format
- Lock Range: 27 kHz – 200 kHz
- Jitter when synced to input signal: < 1 ns
- Jitter suppression: > 30 dB (2.4 kHz)

Word Clock

- BNC, not terminated (10 kOhm)
- Optional internal termination 75 Ohm
- Automatic Double/Quad Speed detection and internal conversion to Single Speed
- SteadyClock guarantees super low jitter synchronization even in varispeed operation
- Not affected by DC-offsets within the network
- Signal Adaptation Circuit: signal refresh through auto-center and hysteresis
- Overvoltage protection
- Level range: 1.0 Vpp – 5.6 Vpp
- Lock Range: 27 kHz – 200 kHz
- Jitter when synced to input signal: < 1 ns
- Jitter suppression: > 30 dB (2.4 kHz)

MADI

- Optical via FDDI duplex SC connector
- 62.5/125 and 50/125 compatible
- Accepts 56 channel and 64 channel mode, and 96k frame
- Single Wire: up to 64 channels 24 bit 48 kHz
- Double Wire / 96k frame: up to 32 channels 24 bit 96 kHz
- Quad Wire: up to 16 channels 24 bit 192 kHz
- Lock range: 28 kHz – 54 kHz
- Jitter when synced to input signal: < 1 ns
- Jitter suppression: > 30 dB (2.4 kHz)

21.3 Digital Outputs

AES/EBU

- 4 x, transformer-balanced, galvanically isolated, according to AES3-1992
- Output voltage Professional 4.0 Vpp
- Format Professional according to AES3-1992 Amendment 4
- Single Wire: 4 x 2 channels 24 bit, up to 192 kHz

ADAT

- 2 x TOSLINK
- Standard: 8 channels 24 bit, up to 48 kHz
- S/MUX: 16 channels 24 bit / 48 kHz, equalling 8 channels 24 bit 96 kHz
- S/MUX4: 16 channels 24 bit / 48 kHz, equalling 4 channels 24 bit 192 kHz

Word Clock

- BNC
- Max. output voltage: 5 Vpp
- Output voltage @ 75 Ohm: 4.0 Vpp
- Impedance: 10 Ohms
- Frequency range: 27 kHz – 200 kHz

MADI

- Optical via FDDI duplex SC connector
- 62.5/125 and 50/125 compatible
- Cable length optical up to 2000 m
- Generates 56 channel and 64 channel mode, and 96k frame
- Single Wire: up to 64 channels 24 bit 48 kHz
- Double Wire / 96k frame: up to 32 channels 24 bit 96 kHz
- Quad Wire: up to 16 channels 24 bit 192 kHz

21.4 Digital

- Clocks: Internal, AES In, ADAT In, word clock In, MADI In
- Low Jitter Design: < 1 ns in PLL mode, all inputs
- Internal clock: 800 ps Jitter, Random Spread Spectrum
- Jitter suppression of external clocks: > 30 dB (2.4 kHz)
- Effective clock jitter influence on AD-conversion: near zero
- PLL ensures zero dropout, even at more than 100 ns jitter
- Supported sample rates: 28 kHz up to 200 kHz

21.5 MIDI

- 16 channels MIDI
- 5-pin DIN jacks
- Optocoupled, ground-free input

MIDI over MADI

- Invisible transmission via User bit of channel 56 (48k frame)

21.6 General

- Power supply: Internal switching PSU, 100 - 240 V AC, 30 Watts
- Typical power consumption: 14 Watts
- Maximum power consumption: < 20 Watts
- Dimensions including rack ears (WxHxD): 483 x 88 x 242 mm (19" x 3.46" x 9.5")
- Dimensions without rack ears/handles (WxHxD): 436 x 88 x 235 mm (17.2" x 3.46" x 9.3")
- Weight: 3 kg (6.6 lbs)
- Temperature range: +5° up to +50° Celsius (41° F up to 122°F)
- Relative humidity: < 75%, non condensing

21.7 Firmware

The OctaMic XTC is internally based on programmable logic. By re-programming of a little component called Flash-PROM, both function and behaviour of the unit can be changed at any time.

At the time of writing this manual, the unit is shipped with firmware 21/35. The firmware version is displayed after power on for about one second on the display, and listed in the menu SETUP – *Options* – *General Settings* – SW-Version.

Firmware Updates: If available then they are found on the RME website (www.rme-audio.de) in the section Downloads, free of charge. See chapter 16 for more details.

21.8 MADI User Bit Chart

- RS-232: channels 1 to 9 (internal through mode always active)
- ADC: channel 19
- MIDI: channel 56 (48k) / 28 (96k)

21.9 Connector Pinouts

The 25 pin D-sub connector provides four AES inputs and outputs. The pinout uses the widely spread Tascam scheme, which is also used by Digidesign.

Tascam / Digidesign:

Signal	In 1/2+	In 1/2-	In 3/4+	In 3/4-	In 5/6+	In 5/6-	In 7/8+	In 7/8-
D-Sub	24	12	10	23	21	9	7	20

Signal	Out 1/2+	Out 1/2-	Out 3/4+	Out 3/4-	Out 5/6+	Out 5/6-	Out 7/8+	Out 7/8-
D-Sub	18	6	4	17	15	3	1	14

GND is connected to pins 2, 5, 8, 11, 16, 19, 22, 25. Pin 13 is not connected.

The Yamaha pinout is quite popular as well. When building a D-sub to D-sub adapter or connection cable, please make sure that the connectors are clearly labelled with *Tascam* and *Yamaha*. The cable can only be used when the Tascam side is connected to a Tascam connector, and the Yamaha side is connected to a Yamaha connector.

Yamaha:

Signal	In 1/2+	In 1/2-	In 3/4+	In 3/4-	In 5/6+	In 5/6-	In 7/8+	In 7/8-
D-Sub	1	14	2	15	3	16	4	17

Signal	Out 1/2+	Out 1/2-	Out 3/4+	Out 3/4-	Out 5/6+	Out 5/6-	Out 7/8+	Out 7/8-
D-Sub	5	18	6	19	7	20	8	21

GND is connected to pins 9, 10, 11, 12, 13, 22, 23, 24, 25.

The same is true for a direct adapter cable Tascam D-sub to Euphonix D-sub.

Euphonix:

Signal	In 1/2+	In 1/2-	In 3/4+	In 3/4-	In 5/6+	In 5/6-	In 7/8+	In 7/8-
D-Sub	15	2	4	16	18	5	7	19

Signal	Out 1/2+	Out 1/2-	Out 3/4+	Out 3/4-	Out 5/6+	Out 5/6-	Out 7/8+	Out 7/8-
D-Sub	21	8	10	22	24	11	13	25

GND is connected to pins 3, 6, 9, 12, 14, 17, 20, 23. Pin 1 is not connected.

XLR sockets analog input 1 - 8

The XLR connectors of the analog inputs are wired according to international standards:

- 1 = GND (shield)
- 2 = + (hot)
- 3 = - (cold)

TRS jacks analog input 1 - 4

The stereo 1/4" TRS jacks of the analog inputs are wired according to international standards:

- Tip = + (hot)
- Ring = - (cold)
- Sleeve = GND

TS jacks analog input 5 - 8

Inputs 5 to 8 are unbalanced:

- Tip = + (hot)
- Ring = n.c. (not connected)
- Sleeve = GND

TRS Phones jack

The analog monitor outputs on the front are accessible through stereo 1/4" TRS jacks. This allows a direct connection of headphones. In case the output should operate as Line output, an adapter TRS plug to RCA phono plugs, or TRS plug to TS plugs is required.

The pin assignment follows international standards. The left channel is connected to the tip, the right channel to the ring of the TRS jack/plug.

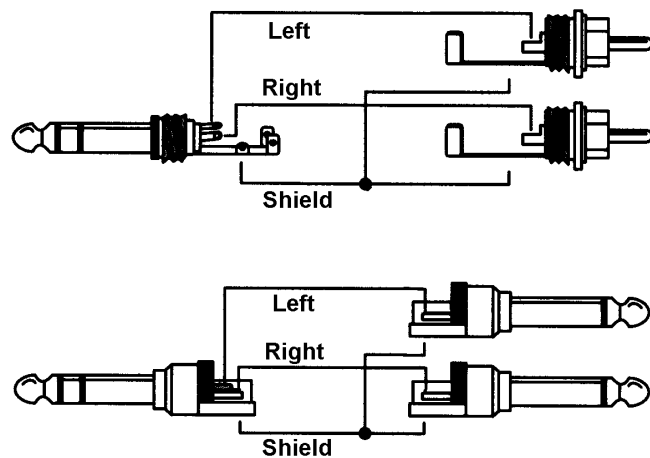

22. Technical Background

22.1 Terminology

Single Speed

Sample rate range originally used in Digital Audio. Typical applications are 32 kHz (digital radio broadcast), 44.1 kHz (CD), and 48 kHz (DAT).

Double Speed

Doubles the original sample rate range, in order to achieve higher audio quality and improved audio processing. 64 kHz is practically never used, 88.2 kHz is quite rare in spite of certain advantages. 96 kHz is a common format. Sometimes called **Double Fast**.

Quad Speed

Controversially discussed way of ensuring hi-end audio quality and processing by quadrupling the sample frequency. 128 kHz is non-existent, 176.4 kHz is rare, if at all then 192 kHz is used, e.g. for DVD Audio.

Single Wire

Standard audio data transfer, where the audio signal's sample rate is equal to the rate of the digital signal. Used from 32 to 192 kHz. Sometimes called **Single Wide**.

Double Wire

Before 1998 there were no receiver/transmitter circuits available that could receive or transmit more than 48 kHz. Higher sample rates were transferred by splitting odd and even bits across the L/R channels of a single AES connection. This provides for twice the data rate, and hence twice the sample rate. A stereo signal subsequently requires two AES/EBU ports.

The Double Wire method is an industry standard today, however it has a number of different names, like **Dual AES**, **Double Wide**, **Dual Line** and **Wide Wire**. The AES3 specification uses the uncommon term *Single channel double sampling frequency mode*. When used with the ADAT format, the term S/MUX is commonly used.

Double Wire not only works with Single Speed signals, but also with Double Speed. As an example, Pro Tools HD, whose AES receiver/transmitter only work up to 96 kHz, uses Double Wire to transmit 192 kHz. Four channels of 96 kHz turn into two channels of 192 kHz.

Quad Wire

Similar to Double Wire, with samples of one channel spread across four channels. This way single speed devices can transmit up to 192 kHz, but need two AES/EBU ports to transmit one channel. Also called **Quad AES**.

S/MUX

Since the ADAT hardware interface is limited to Single Speed, the Double Wire method is used for sample rates up to 96 kHz, but usually referred to as S/MUX (Sample Multiplexing). An ADAT port supports four channels this way.

S/MUX4

The Quad Wire method allows to transmit two channels at up to 192 kHz via ADAT. The method is referred to as S/MUX4.

Note: All conversions of the described methods are lossless. The existing samples are just spread or re-united between the channels.

22.2 Lock and SyncCheck

Digital signals consist of a carrier and the data. If a digital signal is applied to an input, the receiver has to synchronize to the carrier clock in order to read the data correctly. To achieve this, the receiver uses a PLL (Phase Locked Loop). As soon as the receiver meets the exact frequency of the incoming signal, it is locked. This **Lock** state remains even with small changes of the frequency, because the PLL tracks the receiver's frequency.

If an AES or MADI signal is applied to the OctaMic XTC, the corresponding LED starts flashing. The unit indicates LOCK, i. e. a valid input signal (in case the signal is in sync, the LED is constantly lit, see below).

Unfortunately, LOCK does not necessarily mean that the received signal is correct with respect to the clock which processes the read out of the embedded data. Example [1]: The OctaMic XTC is set to 44.1 kHz internal clock (clock mode master), and a mixing desk with MADI output is connected to the XTC MADI input. The MADI LED will start flashing immediately, because the mixing desk's sample rate is generated internally, and thus slightly higher or lower than the XTC's internal sample rate. Result: When reading out the data, there will frequently be read errors that cause clicks and drop outs.

Also when using multiple inputs, a simple LOCK is not sufficient. The above described problem can be solved elegantly by setting the OctaMic XTC from internal clock to MADI In (its internal clock will then be the clock delivered by the mixing desk). But in case another asynchronous device is connected, there will again be a slight difference in the sample rate, and therefore clicks and drop outs.

In order to display those problems optically at the device, the OctaMic XTC includes **Sync-Check**. It checks all clocks used for *synchronicity*. If they are not synchronous to each other (i. e. absolutely identical), the LED of the asynchronous input flashes. In case they are synchronous the LED stays dark, only the LED of the current clock source will be lit (constantly). In example 1 it would have been obvious that the STATE MADI LED keeps flashing after connecting the mixing desk.

In practice, SyncCheck allows for a quick overview of the correct configuration of all digital devices. This way one of the most difficult and error-prone topics of the digital studio world finally becomes easy to handle.

22.3 Latency and Monitoring

The term **Zero Latency Monitoring** has been introduced by RME in 1998 for the DIGI96 series and describes the ability to pass-through the computer's input signal at the interface directly to the output. Since then, the idea behind has become one of the most important features of modern hard disk recording. In the year 2000, RME published two ground-breaking Tech Infos on the topics *Low Latency Background*, which are still up-to-date: *Monitoring, ZLM and ASIO*, and *Buffer and Latency Jitter*, found on the RME website.

How much Zero is Zero?

From a technical view there is no zero. Even the analog pass-through is subject to phase errors, equalling a delay between input and output. However, delays below certain values can subjectively be claimed to be a zero-latency. This applies to analog routing and mixing, and in our opinion also to RME's Zero Latency Monitoring. RME's digital receiver's buffer and the output via the transmitter cause a typical delay of 3 samples. At 44.1 kHz this equals about 68 µs (0.000068 s), at 192 kHz only 15 µs.

Oversampling

While the delays of digital interfaces can be disregarded altogether, the analog inputs and outputs do cause a significant delay. Modern converter chips operate with 64 or 128 times oversampling plus digital filtering, in order to move the error-prone analog filters away from the audible frequency range as far as possible. This typically generates a delay of about 40 samples, equalling one millisecond. A playback and re-record of the same signal via DA and AD (loop-back) then causes an offset of the newly recorded track of about 2 ms.

Low Latency!

The OctaMic XTC uses latest AD-converters with special low latency filters, exceptional Signal to Noise ratio, lowest distortion figures and lightning quick conversion. A delay of only 10 samples hasn't been available just a few years back. But even the chip used for DA-conversion has a lower delay than usual. The exact delays caused by the AD-conversion of the OctaMic XTC are:

Sample frequency kHz	44.1	48	88.2	96	176.4	192
AD (12.6 x 1/fs) ms	0.28	0.26	0.14	0.13		
AD (9.8 x 1/fs) ms					0.06	0.05
DA (28 x 1/fs) ms	0.63	0.58	0.32	0.29	0.16	0.15

These values are smaller than those available from even much more expensive devices. They represent an important step in further reducing the latency in the computer-based recording studio.

22.4 DS - Double Speed

When activating the *Double Speed* mode the OctaMic XTC operates at double sample rate. The internal clock 44.1 kHz turns to 88.2 kHz, 48 kHz to 96 kHz. The internal resolution is still 24 bit.

Sample rates above 48 kHz were not always taken for granted, and are still not widely used because of the CD format (44.1 kHz) dominating everything. Before 1998 there were no receiver/transmitter circuits available that could receive or transmit more than 48 kHz. Therefore a work-around was used: instead of two channels, one AES line only carries one channel, whose odd and even samples are being distributed to the former left and right channels. By this, you get the double amount of data, i. e. also double sample rate. Of course in order to transmit a stereo signal two AES/EBU ports are necessary then.

This transmission mode is called *Double Wire* in the professional studio world, and is also known as *S/MUX (Sample Multiplexing)* in connection with the ADAT format.

Not before February 1998, Crystal shipped the first 'single wire' receiver/transmitters that could also work with double sample rate. It was then possible to transmit two channels of 96 kHz data via one AES/EBU port.

But *Double Wire* is still far from being dead. On one hand, there are still many devices which can't handle more than 48 kHz, e. g. digital tape recorders. But also other common interfaces like ADAT or TDIF are still using this technique.

Because the ADAT interface does not allow for sampling frequencies above 48 kHz (a limitation of the interface hardware), the OctaMic XTC automatically uses *Sample Multiplexing* in DS mode. One channel's data is distributed to two channels according to the following table:

Original	1	2	3	4	5	6	7	8
DS Signal	1/2	3/4	5/6	7/8	1/2	3/4	5/6	7/8
Port	1	1	1	1	2	2	2	2

As the transmission of double rate signals is done at standard sample rate (Single Speed), the ADAT outputs still deliver 44.1 kHz or 48 kHz.

22.5 QS – Quad Speed

Due to the small number of available devices that use sample rates up to 192 kHz, but even more due to a missing real world application (CD...), Quad Speed has had no broad success so far. An implementation of the ADAT format as double S/MUX (S/MUX4) results in only two channels per optical output. Therefore in Quad Speed mode the OctaMic XTC is limited to 4 channels at the ADAT outputs.

The AES outputs provide 192 kHz as Single Wire only.

22.6 AES/EBU - SPDIF

The most important electrical properties of 'AES' and 'SPDIF' can be seen in the table below. AES/EBU is the professional balanced connection using XLR plugs. The standard is being set by the *Audio Engineering Society* based on the AES3-1992. For the 'home user', SONY and Philips have omitted the balanced connection and use either Phono plugs or optical cables (TOSLINK). The format called S/P-DIF (SONY/Philips Digital Interface) is described by IEC 60958.

Type	AES3-1992	IEC 60958
Connection	XLR	RCA / Optical
Mode	Balanced	Unbalanced
Impedance	110 Ohm	75 Ohm
Level	0.2 V up to 5 Vpp	0.2 V up to 0.5 Vpp
Clock accuracy	not specified	I: ± 50 ppm II: 0.1% III: Variable Pitch
Jitter	< 0.025 UI (4.4 ns @ 44.1 kHz)	not specified

Besides the electrical differences, both formats also have a slightly different setup. The two formats are compatible in principle, because the audio information is stored in the same place in the data stream. However, there are blocks of additional information, which are different for both standards. In the table, the meaning of the first byte (#0) is shown for both formats. The first bit already determines whether the following bits should be read as Professional or Consumer information.

Byte	Mode	Bit 0	1	2	3	4	5	6	7
0	Pro	P/C	Audio?		Emphasis		Locked	Sample Freq.	
0	Con	P/C	Audio?	Copy	Emphasis			Mode	

It becomes obvious that the meaning of the following bits differs quite substantially between the two formats. If a device like a common DAT recorder only has an SPDIF input, it usually understands only this format. In most cases, it will switch off when being fed Professional-coded data. The table shows that a Professional-coded signal would lead to malfunctions for copy prohibition and emphasis, if being read as Consumer-coded data.

Nowadays many devices with SPDIF input can handle Professional subcode. Devices with AES3 input almost always accept Consumer SPDIF (passive cable adapter required).

22.7 Signal to Noise Ratio in DS- / QS-Operation

The outstanding signal to noise ratio of the OctaMic XTC's AD-converters can be verified even without expensive test equipment, by using record level meters of various software. But when activating the DS and QS mode, the displayed noise level will rise from -113 dBFS to -106 dBFS at 96 kHz, and -79 dBFS at 192 kHz. This is not a failure. The software measures the noise of the whole frequency range, at 96 kHz from 0 Hz to 48 kHz (RMS unweighted), at 192 kHz from 0 Hz to 96 kHz.

When limiting the measurement range from 20 Hz to 20 kHz (so called audio bandpass) the value would be -113 dB again. This can be verified with RME's *DIGICheck*. The function **Bit Statistic & Noise** measures the noise floor by *Limited Bandwidth*, ignoring DC and ultrasound.

Subframe	MSB	Audio Data	LSB	AUX	CUV	RMS LB [dB+3]	RMS [dBA+3]	DC [dB]
1 - Left	*****	*****	*****	*****	00	-113.8	-116.9	-138.5
2 - Right	*****	*****	*****	*****	00	-113.8	-116.9	-138.6
Bits	4	8	12	16	20	24	20Hz ... 20kHz	A-weighting

The reason for this behaviour is the noise shaping technology of the analog to digital converters. They move all noise and distortion to the in-audible higher frequency range, above 30 kHz. That's how they achieve their outstanding performance and sonic clarity. Therefore the noise is slightly increased in the ultrasound area. High-frequent noise has a high energy. Add the quadrupled bandwidth, and a wideband measurement will show a significant drop in SNR, while the human ear will notice absolutely no change in the audible noise floor.

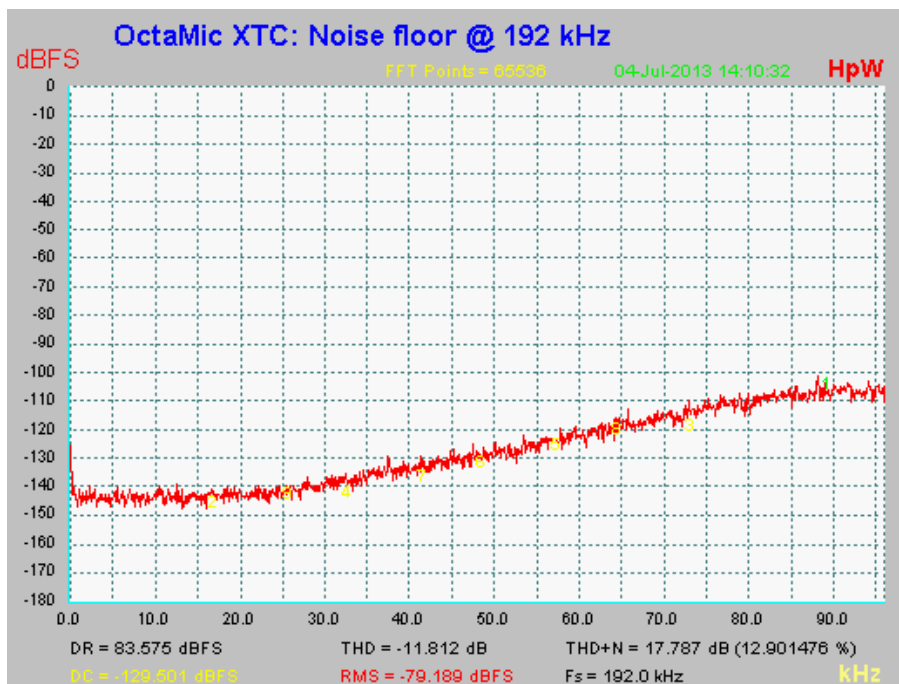

As can be seen in the above picture, the noise floor stays fully unchanged up to 30 kHz. With sample rates up to 96 kHz the noise shaping happens outside of the transmission range.

22.8 MADl Basics

MADl, the serial **M**ultichannel **A**udio **D**igital **I**nterface, has been defined already in 1989 as an extension of the existing AES3 standard following several manufacturers' wish. The format also known as AES/EBU, a balanced bi-phase signal, is limited to two channels. Simply put, MADl contains 28 of those AES/EBU signals in serial, i. e. after one another, and the sample rate can still even vary by +/-12.5%. The limit which cannot be exceeded is a data rate of 100Mbit/s.

Because an exact sampling frequency is used in most cases, the 64 channel mode was introduced officially in 2001. It allows for a maximum sample rate of 48 kHz + ca. 1%, corresponding to 32 channels at 96 kHz, without exceeding the maximum data rate of 100 Mbit/s. The effective data rate of the port is 125 Mbit/s due to additional coding.

Older devices understand and generate only the 56 channel format. Newer devices often work in the 64 channel format, but offer still no more than 56 audio channels. The rest is being eaten up by control commands for mixer settings etc.. The OctaMic XTC shows that this can be done in a much better way, with an invisible transmission of 16 MIDI channels plus serial RS232 data stream, and the 64-channel MADl signal still being 100% compatible.

For the transmission of the MADl signal, proved methods known from network technology were applied. Most people know unbalanced (coaxial) cables with 75 Ohms BNC plugs, they are not expensive and easy to get. The optical interface is much more interesting due to its complete galvanic separation, but for many users it is a mystery, because very few have ever dealt with huge cabinets full of professional network technology. Therefore here are some explanations regarding 'MADl optical'.

- The cables used are standard in computer network technology. They are thus not at all expensive, but unfortunately not available in every computer store.
- The cables have an internal fibre of only 50 or 62.5 µm diameter and a coating of 125 µm. They are called network cables 62.5/125 or 50/125, the former mostly being blue and the latter mostly being orange. Although in many cases not clearly labelled, these are always (!) glass fibre cables. Plastic fibre cables (POF, plastic optical fibre) can not be manufactured in such small diameters.
- The plugs used are also an industry standard and called SC. Please don't mix them up with ST connectors, which look similar to BNC connectors and are being screwed. Plugs used in the past (MIC/R) were unnecessarily big and are not being used any longer.
- The cables are available as a duplex variant (2 cables being glued together) or as a simplex variant (1 cable). The OctaMic XTC's opto module supports both variants.
- The transmission uses the multimode technique which supports cable lengths of up to almost 2 km. Single mode allows for much longer distances, but it uses a completely different fibre (8 µm). By the way, due to the wave-length of the light being used (1300 nm), the optical signal is invisible to the human eye.

22.10 SteadyClock

The SteadyClock technology of the OctaMic XTC guarantees an excellent performance in all clock modes. Its highly efficient jitter suppression refreshes and cleans up any clock signal, and provides it as reference clock at the word clock output.

Usually a clock section consists of an analog PLL for external synchronization and several quartz oscillators for internal synchronisation. SteadyClock requires only one quartz, using a frequency not equalling digital audio. Latest circuit designs like hi-speed digital synthesizer, digital PLL, 100 MHz sample rate and analog filtering allow RME to realize a completely newly developed clock technology, right within the FPGA at lowest costs. The clock's performance exceeds even professional expectations. Despite its remarkable features, SteadyClock reacts quite fast compared to other techniques. It locks in fractions of a second to the input signal, follows even extreme varipitch changes with phase accuracy, and locks directly within a range of 28 kHz up to 200 kHz.

SteadyClock has originally been developed to gain a stable and clean clock from the heavily jittery MADI data signal. The embedded MADI clock suffers from about 80 ns jitter, caused by the time resolution of 125 MHz within the format. Common jitter values for other devices are 5 ns, while a very good clock will have less than 2 ns.

The picture to the right shows the MADI input signal with 80 ns of jitter (top graph, yellow). Thanks to SteadyClock this signal turns into a clock with less than 2 ns jitter (lower graph, blue).

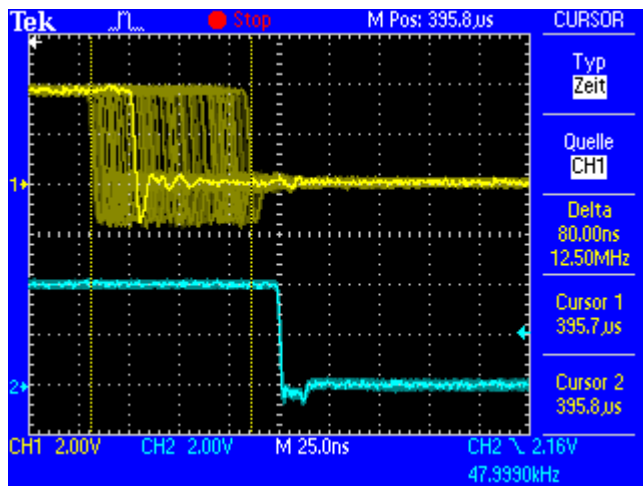

Using the other input sources of the OctaMic XTC, word clock, ADAT and and AES/EBU, you'll most probably never experience such high jitter values. But SteadyClock is not only ready for them, it would handle them just on the fly.

The screenshot to the right shows an extremely jittery word clock signal of about 50 ns jitter (top graph, yellow). Again SteadyClock provides an extreme clean-up. The filtered clock shows less than 2 ns jitter (lower graph, blue).

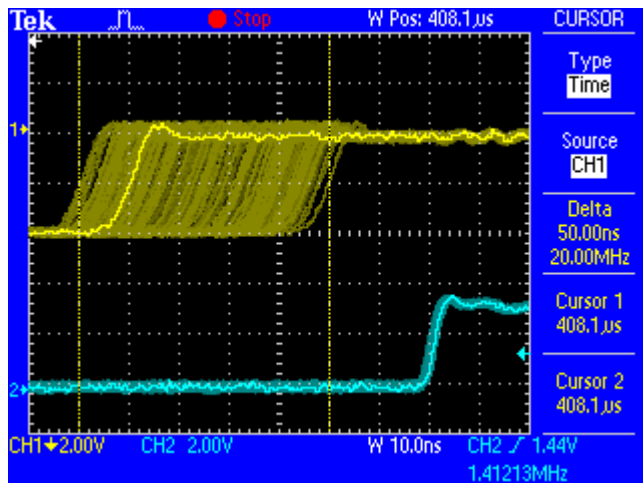

The cleaned and jitter-free signal can be used as reference clock for any application, without any problem. The signal processed by SteadyClock is of course not only used internally, but also available at the XTC's word clock output. It is also used to clock the digital outputs MADI, ADAT and AES/EBU.

23. Block Diagram

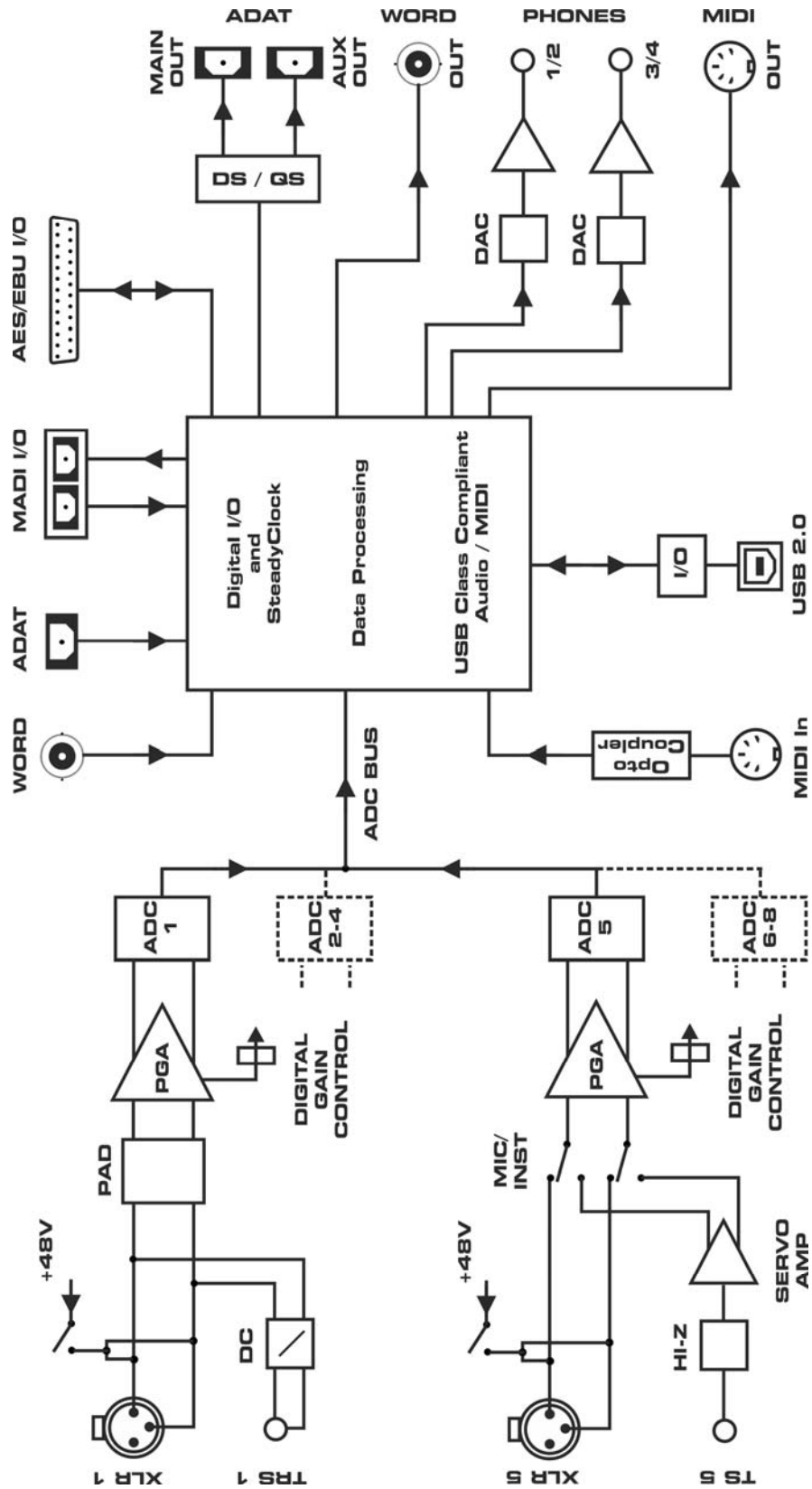

24. MIDI Implementation OctaMic XTC

24.1 Basic SysEx Format

<u>Value</u>	<u>Name</u>
F0h	SysEx header
00h 20h 0Dh	MIDITEMP manufacturer ID
69h	Model ID (OctaMic XTC)
00h..7Eh, 7Fh	MIDI device ID
mm	Command ID
nn	Data (parameter index, parameter LSB, parameter MSB, set-flags, ...)
F7h	EOX

24.2 Message Types - Commands

<u>Value</u>	<u>Name</u>
10h	Request value
11h	Request level meter data
012h	Request changed parameters
020h	Set parameter (multiple parameters allowed)
30h	Send parameters (multiple parameters allowed)

Request Value

Format: F0 00 20 0D 69 (dev ID) 10 F7

This string triggers a complete dump of all parameter data bytes.

Value Response

After being triggered by receiving a request parameter command, device sends a string of all parameter data bytes. Message type is set to 30h.

Set Parameter

Sets any number of parameters.

mm / nn can be repeated freely.

Request Level Meter Data

Format: F0 00 20 0D 69 (dev ID) 11 F7

This string triggers a dump of the level meter data.

0xf0, 0x00, 0x20, 0x0d, 0x69

MIDI device ID, command ID, parameter index, parameter LSB, parameter MSB, set-flags, ..., 0xf7

(... = multiple parameters per message allowed, each consisting of index, LSB, MSB, set-flags)

Set-flags: set to value from list to set the according parameter in the device, otherwise parameter will be ignored. Set-flags are only assigned for commands containing multiple parameters. Messages sent by the device (command ID 0x30) do not contain set-flags.

Example for MIDI device ID 0

f0 00 20 0 69 00 20 01 1c 08 7f 0a 30 10 0d f7

Set Gain Mic 2 to 37dB; Pad on; Phase-Invert, Mute, AutoSet, 48V off; all parameters to be set. Set Phones 1 source to MADI1/2; high Level, Phase-Invert off, Mute not to be set.

24.3 Table

Commands

ID	Command	Send	Rec
0x10	request all parameters (incl. level data)		x
0x11	request level data		x
0x12	request changed parameters (in case of no changes: empty block)		x
0x20	set parameter (multiple parameters allowed)		x
0x30	send parameters (multiple parameters possible)	x	

Parameters

Index	Value	Send	Rec	Flag
0	Channel Settings Mic 1 (see Details below)	x	x	s.d.
1	Channel Settings Mic 2	x	x	s.d.
2	Channel Settings Mic 3	x	x	s.d.
3	Channel Settings Mic 4	x	x	s.d.
4	Channel Settings Mic 5	x	x	s.d.
5	Channel Settings Mic 6	x	x	s.d.
6	Channel Settings Mic 7	x	x	s.d.
7	Channel Settings Mic 8	x	x	s.d.
8	Phones 1 Volume (see Details below)	x	x	n.a.
9	Phones 1 Balance	x	x	n.a.
10	Phones 1 Settings	x	x	s.d.
11	Phones 2 Volume	x	x	n.a.
12	Phones 2 Balance	x	x	n.a.
13	Phones 2 Settings	x	x	s.d.
14	Digital Routing ADAT Out, ADAT2 Out (see Details below)	x	x	s.d.
15	Digital Routing AES Out	x	x	s.d.
16	Digital Routing MADI 1-8, MADI 9-16	x	x	s.d.
17	Digital Routing MADI 17-24, MADI 25-32	x	x	s.d.
18	Digital Routing MADI 33-40, MADI 41-48	x	x	s.d.
19	Digital Routing MADI 49-56, MADI 57-64	x	x	s.d.
20	Digital Routing Rec. 9-16, Rec. 17-24	x	x	s.d.
21	Clock Settings	x	x	
LSB	Bit 0-3: Clock Source (internal, WCK, AES1..AES4, ADAT, MADI)			0x01
	Bit 4: WCK always single			0x02
	Bit 5: WCK termination active			0x04
MSB	Bit 0-3: Samplerate index (32k, 44.1k, 48k, 64k, 88.2k, 96k, 128k, 176.4k, 192k)			0x08
22	MADI Settings			
LSB	Bit 0-1: Delay Compensation (0-Off, 1-Manual, 2-Auto-ID, 3-Auto CA)	x	x	0x01
LSB	Bit 2: MADI-Format (0: 56ch, 1: 64ch)	x	x	0x02
LSB	Bit 3: MADI-Frame (0: 96k, 1: 48k)	x	x	0x04
MSB	Bit 0-2: Delay Compensation ID (0-7 for ID 1-8)	x	x	0x08

23	MIDI Source Select	x	x	
LSB	Bit 0-2: Source USB1 Output (see Value Table 2)			0x01
	Bit 3-6: Source USB2 Output (see Value Table 2)			0x02
MSB	Bit 0-2: Source DIN Output (see Value Table 2)			0x04
	Bit 3-6: Source MIDI over MADI (see Value Table 2)			0x08
24	Group Enable	x	x	
LSB	Bit 0-3: Group 1..4 enable (ON)			n.a.
MSB	Bit 0-3: Group 1..4 AutoSet (AS)			n.a.
25	Save/Load Preset (Receive only)		x	
LSB	Load Preset 1..6, 0 for no operation			n.a.
MSB	Save Preset 1..6, 0 for no operation			n.a.
25	Input State Lock/Sync (Send only at request of all params)	x		
LSB	Lock: Bit 0: WCK, Bit 1-4: AES1-4, Bit 5: MADI, Bit 6: ADAT			n.a.
MSB	Sync: Bit 0: WCK, Bit 1-4: AES1-4, Bit 5: MADI, Bit 6: ADAT			n.a.
26	Group Gain adjust		x	
LSB	Delta Gain +64dB (0: -64dB, 64: 0dB, 127: +63dB)			n.a.
MSB	Group (1-4)			n.a.

Level Meter data

26	Level Meter Mic 1 / 2 (see details below)	x		n.a.
27	Level Meter Mic 3 / 4	x		n.a.
28	Level Meter Mic 5 / 6	x		n.a.
29	Level Meter Mic 7 / 8	x		n.a.
30	Level Meter Phones 1	x		n.a.
31	Level Meter Phones 2	x		n.a.

Details

Channel Settings Mic		Flag
LSB	Bit 0-5 Gain (0: 0dB, 1: 10dB...56:65dB)	0x01
	Bit 6: Phase Invert	0x02
MSB	Bit 0: Mute	0x04
	Bit 1: AutoSet	0x08
	Bit 2: +48V	0x10
	Bit 3: Pad (Channel 1-4)/Instrument (Channel 5-8)	0x20
	Bit 4-6: Group (0: off, 1..4: group)	0x40

Digital Routing		
LSB	Bit 0-3: Source 1 (see Value Table 2)	0x01
MSB	Bit 0-3: Source 2 (see Value Table 2)	0x02

Phones Volume		
LSB	Bit 0-3: 1/10 dB of Volume[dB]+65.0	n.a.
MSB	integer part of Volume[dB]+65.0 (0...71 for -65...+6dB)	

Phones Balance		
LSB	1/100 Balance	n.a.
MSB	Bit 0: Left (1) / Right (0)	

Phones Settings		
LSB	Source Bit 0..6	0x01
MSB	Bit 0: Bit 7 Source (see Value Table 1)	
	Bit 1: Mute	0x02
	Bit 2-3: Phase Invert (0: off, 1: both, 2: left, 3: right)	0x04
	Bit 4: Level (0: Low, 1: High)	0x08

Level Meter (Send only)		
LSB	Channel 1	
MSB	Channel 2	
Value	126: OVR	
	125..95: 0dB..-6dB (p[dB] = (Value – 125) * 0.2)	
	94...23: -6.5dB..-42dB (p[dB] = (Value – 107) * 0.5)	
	22..1: -43..-64dB (p[dB] = Value – 65)	
	0: underflow	

Abbreviations

n.a. not assigned
s.d. see details

Value Table 1 – Phones Sources

	0	1	2	3	4	5	6	7
0..	Play 1/2	Play 3/4	Mic 1	Mic 2	Mic 3	Mic 4	Mic 5	Mic 6
8..	Mic 7	Mic 8	Mic 1/2	Mic 3/4	Mic 5/6	Mic 7/8	Mic 1-8	Mic 1-8S
16..	ADAT 1	ADAT 2	ADAT 3	ADAT 4	ADAT 5	ADAT 6	ADAT 7	ADAT 8
24..	ADAT 1/2	ADAT 3/4	ADAT 5/6	ADAT 7/8	AES 1	AES 2	AES 3	AES 4
32..	AES 5	AES 6	AES 7	AES 8	AES 1/2	AES 3/4	AES 5/6	AES 7/8
40..	MADI 1	MADI 2	MADI 3	MADI 4	MADI 5	MADI 6	MADI 7	MADI 8
48..	MADI 1/2	MADI 3/4	MADI 5/6	MADI 7/8	MADI 9	MADI 10	MADI 11	MADI 12
56..	MADI 13	MADI 14	MADI 15	MADI 16	MADI 9/10	MA 11/12	MA 13/14	MA 15/16
64..	MADI 17	MADI 18	MADI 19	MADI 20	MADI 21	MADI 22	MADI 23	MADI 24
72..	MA 17/18	MA 19/20	MA 21/22	MA 23/24	MADI 25	MADI 26	MADI 27	MADI 28
80..	MADI 29	MADI 30	MADI 31	MADI 32	MA 25/26	MA 27/28	MA 29/30	MA 31/32
88..	MADI 33	MADI 34	MADI 35	MADI 36	MADI 37	MADI 38	MADI 39	MADI 40
96..	MA 33/34	MA 35/36	MA 37/38	MA 39/40	MADI 41	MADI 42	MADI 43	MADI 44
104..	MADI 45	MADI 46	MADI 47	MADI 48	MA 41/42	MA 43/44	MA 45/46	MA 47/48
112..	MADI 49	MADI 50	MADI 51	MADI 52	MADI 53	MADI 54	MADI 55	MADI 56
120..	MA 49/50	MA 51/52	MA 53/54	MA 55/56	MADI 57	MADI 58	MADI 59	MADI 60
128..	MADI 61	MADI 62	MADI 63	MADI 64	MA 57/58	MA 59/60	MA 61/62	MA 63/64

Value Table 2 – Digital Routing Sources

	0	1	2	3	4	5	6	7
0..	Mic 1-8	ADAT IN	AES IN	M 1-8	M 9-16	M 17-24	M 25-32	M 33-40
8..	M 41-48	M 49-56	M 57-64	PB 1-8	PB 9-12	PB 13-16	PB13-20	PB17-24

Value Table 3 – MIDI Sources

0	1	2	3	4	5
OFF	USB1	USB2	MADI In	DIN in	Control