



**evolution**wireless 

# 500 Series



# Contents

<b>Important safety instructions</b> .....	2
System .....	2
Receiver .....	2
Bodypack transmitter and radio microphone .....	3
<b>The ew 500 G3 evolution wireless series</b> .....	4
The frequency bank system .....	4
<b>Product overview</b> .....	5
Overview of the EM 500 receiver .....	5
Overview of the displays of the EM 500 receiver .....	6
Overview of the SK 500 bodypack transmitter .....	8
Overview of the displays of the SK 500 bodypack transmitter .....	9
Overview of the SKM 500 radio microphone .....	10
Overview of the displays of the SKM 500 radio microphone .....	11
<b>Putting the devices into operation</b> .....	12
EM 500 receiver .....	12
SK 500 bodypack transmitter .....	14
SKM 500 radio microphone .....	16
<b>Using the devices</b> .....	17
Switching the devices on/off .....	18
Synchronizing a transmitter with the receiver .....	21
Deactivating the lock mode temporarily .....	22
Muting the audio signal or deactivating the RF signal .....	23
Selecting a standard display .....	25
<b>Overview of the operating menus</b> .....	26
<b>Cleaning the devices</b> .....	29
<b>Specifications</b> .....	32
<b>Manufacturer Declarations</b> .....	36



For an animated instruction manual, visit the respective product pages at [www.sennheiser.com](http://www.sennheiser.com).



There you will also find detailed instruction manuals for the individual devices.

# Important safety instructions

## System

- Read this instruction manual.
- Keep this instruction manual. Always include this instruction manual when passing the devices and the mains unit on to third parties.
- Heed all warnings and follow all instructions in this instruction manual.
- Only clean the devices when they are not connected to the mains. Use a cloth for cleaning.
- Only use attachments/accessories specified by Sennheiser.
- Refer all servicing to qualified service personnel.  
Servicing is required if the devices or the mains unit have been damaged in any way, liquid has been spilled, objects have fallen inside, the devices have been exposed to rain or moisture, do not operate properly or have been dropped.
- **WARNING:** To reduce the risk of fire or electric shock, do not use the devices and the mains unit near water and do not expose them to rain or moisture.

## Receiver

- Only use the supplied mains unit.
- Unplug the mains unit from the wall socket
  - to completely disconnect the device from the mains,
  - during lightning storms or
  - when unused for long periods of time.
- Only operate the mains unit from the type of power source specified in the chapter “Specifications” (see page 32).
- Ensure that the mains unit is
  - in a safe operating condition and easily accessible,
  - properly plugged into the wall socket,
  - only operated within the permissible temperature range,
  - not covered or exposed to direct sunlight for longer periods of time in order to prevent heat accumulation (see “Specifications” on page 32).
- Do not block any ventilation openings. Install the device in accordance with the instructions given in this instruction manual.
- Do not install the device and the mains unit near any heat sources such as radiators, heat registers, stoves, or other devices (including amplifiers) that produce heat.
- Do not overload wall outlets and extension cables as this may result in fire and electric shock.

- **Danger due to high volumes**  
This device is capable of producing sound pressure exceeding 85 dB(A). 85 dB(A) is the sound pressure corresponding to the maximum permissible volume which is by law (in some countries) allowed to affect your hearing for the duration of a working day. It is used as a basis according to the specifications of industrial medicine. Higher volumes or longer durations can damage your hearing. At higher volumes, the duration must be shortened in order to prevent hearing damage. The following are sure signs that you have been subjected to excessive noise for too long a time:
  - You can hear ringing or whistling sounds in your ears.
  - You have the impression (even for a short time only) that you can no longer hear high notes.

## **Bodypack transmitter and radio microphone**

Do not place the devices near any heat sources such as radiators, heat registers, stoves, or other devices (including amplifiers) that produce heat.

### **Intended use of the system**

Intended use of the ew 500 G3 series devices includes:

- having read this instruction manual especially the chapter “Important safety instructions”,
- using the devices within the operating conditions and limitations described in this instruction manual.

“Improper use” means using the devices other than as described in these instructions, or under operating conditions which differ from those described herein.

## The ew 500 G3 evolution wireless series

With the ew 500 G3 evolution wireless series, Sennheiser offers high-quality state-of-the-art RF transmission systems with a high level of operational reliability and ease of use. Transmitters and receivers permit wireless transmission with studio-quality sound.

### The frequency bank system

Please note: Frequency usage is different for each country. Your Sennheiser partner will have all the necessary details on the available legal frequencies for your area.

The devices are available in 6 UHF frequency ranges with 1,680 frequencies per frequency range:

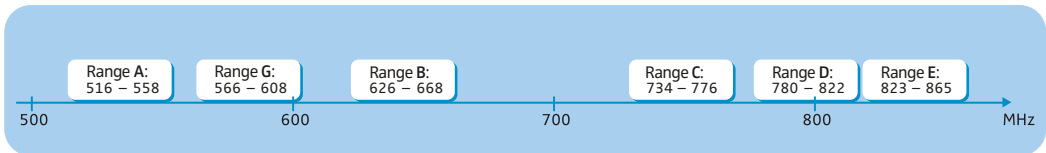

Each frequency range (A–E, G) offers 26 frequency banks with up to 32 channels each:

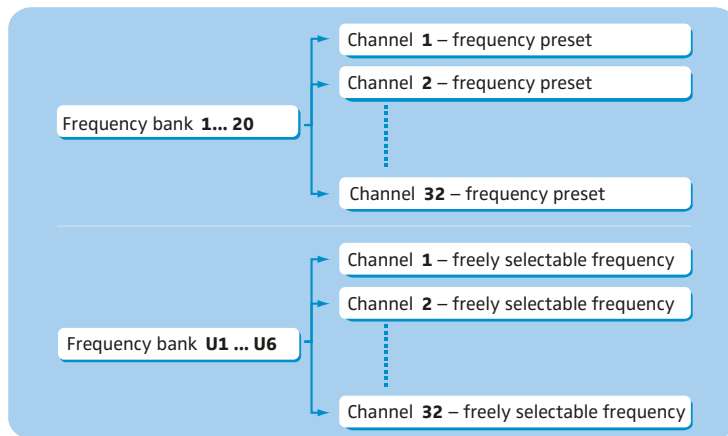

Each of the channels in the frequency banks “1” to “20” has been factory-preset to a fixed frequency (frequency preset). The factory-preset frequencies within one frequency bank are intermodulation-free. These frequencies cannot be changed.

For an overview of the frequency presets, please refer to the supplied frequency information sheet. Updated versions of the frequency information sheet can be downloaded from the product page on our website at [www.sennheiser.com](http://www.sennheiser.com).

The frequency banks “U1” to “U6” allow you to freely select and store frequencies. It might be that these frequencies are **not** intermodulation-free.

# Product overview

## Overview of the EM 500 receiver

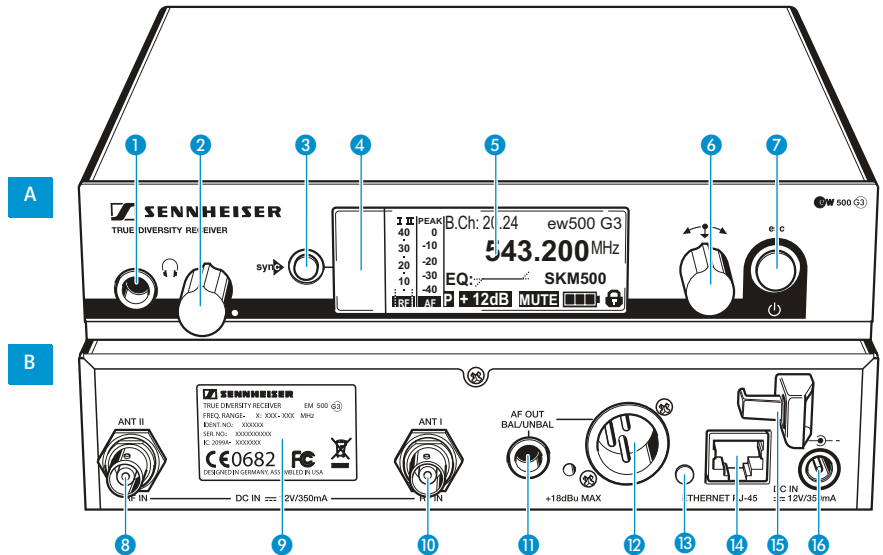

### A Operating elements – front panel

- 1 Headphone output, 1/4" (6.3 mm) jack socket (🎧)
- 2 Headphone volume control
- 3 **syn** button, backlit
- 4 Infra-red interface
- 5 Display panel, backlit in orange
- 6 Jog dial
- 7 **STANDBY** button, serves as the ESC (cancel) key in the operating menu

### B Operating elements – rear panel

- 8 Antenna input II (**ANT II**) with remote power supply input, BNC socket
- 9 Type plate
- 10 Antenna input I (**ANT I**) with remote power supply input, BNC socket
- 11 Audio output (**AF OUT UNBAL**), 1/4" (6.3 mm) jack socket, unbalanced
- 12 Audio output (**AF OUT BAL**), XLR-3M socket, balanced
- 13 LED (yellow) for network activity indication
- 14 LAN socket (**ETHERNET RJ-45**)
- 15 Cable grip for power supply DC cable
- 16 DC socket (**DC IN**) for connection of NT 2-3 mains unit

## Overview of the displays of the EM 500 receiver



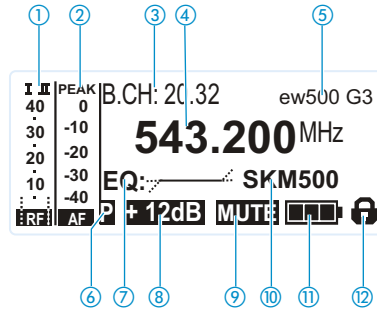

After switch-on, the receiver displays the standard display “Receiver Parameters”. For further illustrations and examples of the different standard displays, please refer to page 25.

This standard display displays the operating states of the receiver and provides the most important information on the received transmitter – provided the linked transmitter supports this function.



Display	Meaning
① RF level “RF” (Radio Frequency)	<p>Diversity display:</p> <p><b>I II</b> Antenna input I is active  <b>I II</b> Antenna input II is active</p> <p>RF signal level:                      Field strength of the transmitted signal</p> <p><b>RF</b> Squelch threshold level</p>
② Audio level “AF” (Audio Frequency)	<p>Modulation of the transmitter with peak hold function.</p> <p>When the level display for audio level shows full deflection, the audio input level is excessively high. When the transmitter is overmodulated frequently or for extended periods of time, the “PEAK” display is shown inverted.</p>
③ Frequency bank and channel	Current frequency bank and channel number
④ Frequency	Current receiving frequency
⑤ Name	Freely selectable name of the receiver
⑥ Pilot tone “P”	Activated pilot tone evaluation
⑦ Equalizer setting	Current equalizer setting
⑧ Output gain	Current output gain
⑨ Muting function “MUTE”	Receiver is muted Receiver does not output an audio signal (see also page 30).
⑩ Transmitter type	Product name of the linked ew G3 transmitter The product name is displayed only if the linked transmitter supports this function.



Display	Meaning
⑪ Transmitter battery status	<p>Charge status:</p> <ul style="list-style-type: none"><li> approx. 100%</li><li> approx. 70%</li><li> approx. 30%</li><li> Battery icon is flashing; charge status is critical</li></ul> <p>When the battery charge status is critical, "LOW BATT" additionally appears on the display panel.</p>
⑫ Lock mode icon	Lock mode is activated

## Overview of the SK 500 bodypack transmitter

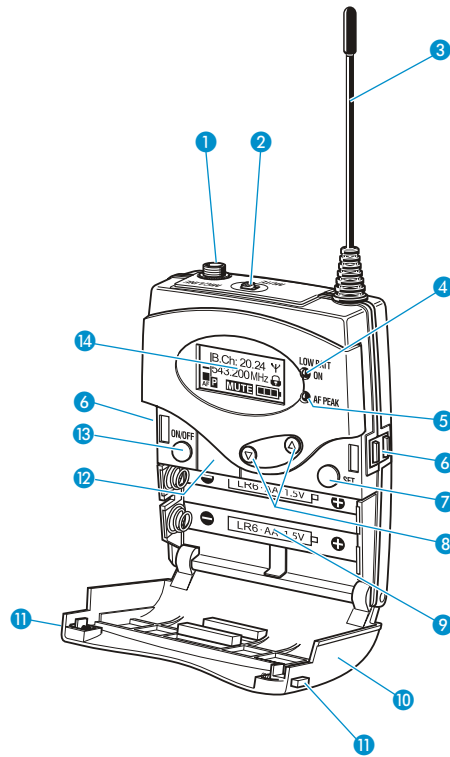





### Operating elements

- |  |   |
|--|---|
| <ul style="list-style-type: none"> <li>1 Microphone/instrument input (MIC/LINE), 3.5 mm jack socket, lockable</li> <li>2 MUTE switch</li> <li>3 Antenna</li> <li>4 Operation and battery status indicator, red LED (lit = ON/flashing = LOW BATTERY)</li> <li>5 Audio overmodulation indicator, yellow LED (lit = AF PEAK)</li> <li>6 Charging contacts</li> </ul> | <ul style="list-style-type: none"> <li>7 SET button</li> <li>8 ▲/▼ rocker button (UP/DOWN)</li> <li>9 Battery compartment</li> <li>10 Battery compartment cover</li> <li>11 Battery compartment catches</li> <li>12 Infra-red interface</li> <li>13 ON/OFF button, serves as the ESC (cancel) key in the operating menu</li> <li>14 Display panel, backlit in orange</li> </ul> |
|--|---|

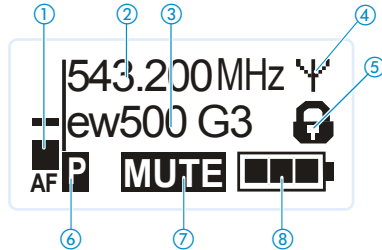
## Overview of the displays of the SK 500 bodypack transmitter

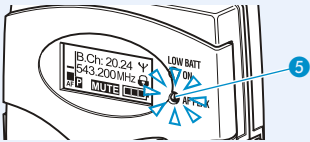
After switch-on, the bodypack transmitter displays the standard display “Frequency/Name”. For further illustrations and examples of the different standard displays, refer to page 25. The display backlighting is automatically reduced after approx. 20 seconds.

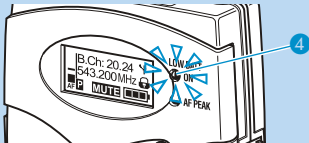

Display	Meaning
① Audio level “AF”	<p>Modulation of the bodypack transmitter with peak hold function</p> <p>When the transmitter’s audio input level is excessively high, the “AF” display shows full deflection and, in addition, the yellow AF PEAK LED ⑤ lights up:</p> 
② Frequency	Current transmission frequency
③ Name	Freely selectable name of the bodypack transmitter
④ Transmission icon	RF signal is being transmitted
⑤ Lock mode icon	Lock mode is activated
⑥ “P” (Pilot)	Pilot tone transmission is activated
⑦ “MUTE”	Microphone or line input is muted
⑧ Battery status	<p>Charge status:</p> <ul style="list-style-type: none"> <li> approx. 100%</li> <li> approx. 70%</li> <li> approx. 30%</li> </ul> <p> Charge status is critical, the red LOW BATT LED ④ is flashing:</p> 

## Overview of the SKM 500 radio microphone

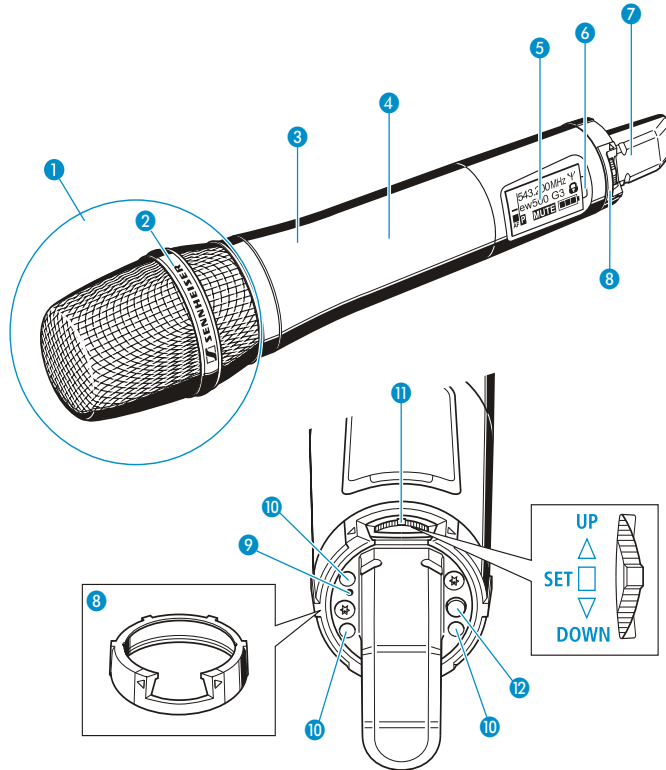





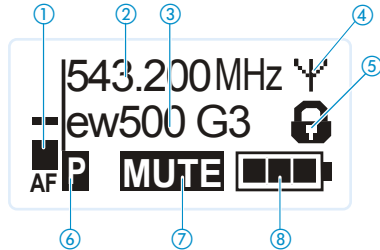

### Operating elements

- 1 Microphone head (interchangeable)
- 2 Name and pick-up pattern of the microphone head (not visible here)
- 3 Body of radio microphone
- 4 Battery compartment (not visible from outside)
- 5 Display panel, backlit in orange
- 6 Infra-red interface
- 7 Antenna
- 8 Color-coded protection ring; available in different colors
- 9 Operation and battery status indicator, red LED  
(lit = ON/flashing = LOW BATTERY)
- 10 Charging contacts
- 11 Multi-function switch:  
▼ (DOWN), ▲ (UP) and ■ (SET)
- 12 ON/OFF button, serves as the ESC (cancel) key in the operating menu

## Overview of the displays of the SKM 500 radio microphone

After switch-on, the radio microphone displays the standard display “Frequency/Name”. For further illustrations and examples of the different standard displays, refer to page 25. The display backlighting is automatically reduced after approx. 20 seconds.

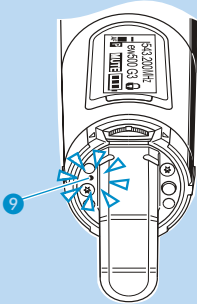

Display	Meaning
① Audio level “AF”	Modulation of the radio microphone with peak hold function
② Frequency	Current transmission frequency
③ Name	Freely selectable name of the radio microphone
④ Transmission icon	RF signal is being transmitted
⑤ Lock mode icon	Lock mode is activated
⑥ “P” (Pilot)	Pilot tone transmission is activated
⑦ “MUTE”	Audio signal is muted
⑧ Battery status	Charge status:  approx. 100%  approx. 70%  approx. 30%  Charge status is critical, the red <b>LOW BATT</b> LED  is flashing: 

## Putting the devices into operation

### EM 500 receiver



You can set up the receiver on a flat surface or mount it into a 19" rack. For information on rack mounting, refer to the instruction manual of the EM 500 receiver available on the ew G3 product page at [www.sennheiser.com](http://www.sennheiser.com).

#### Setting up the receiver on a flat surface

Place the receiver on a flat, horizontal surface. Please note that the device feet can leave stains on delicate surfaces.

#### Fitting the device feet

- ▶ Clean the base of the receiver where you want to fix the device feet.
- ▶ Fit the device feet to the four corners of the receiver.

#### Mounting the rack mount "ears"



The rack mount "ears" are designed to help protect the operating elements from damage or deformation, e.g. if the receiver is dropped. Therefore, fasten the stacking elements, even if you do not want to rack mount your receivers.

To fasten the rack mount "ears" 20:

- ▶ Unscrew and remove the two recessed head screws (M4x8) on each side of the receiver (see diagram).
- ▶ Secure the rack mount "ears" 20 to the sides of the receiver using the previously removed recessed head screws.

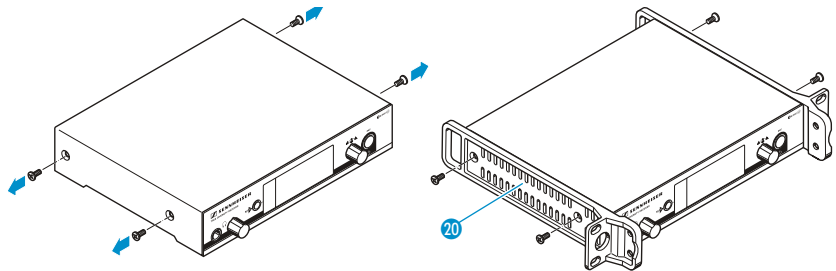

#### Connecting the rod antennas

The supplied rod antennas 17 are suitable for use in good reception conditions.

- ▶ Connect the antennas. You have the following options:
  - You can connect the rod antennas to the rear of the receiver.
  - You can use the optional AM 2 antenna front mount kit and mount the rod antennas to the front of the receiver (see the instruction manual of the EM 500 receiver available on the ew G3 product page at [www.sennheiser.com](http://www.sennheiser.com)).
- ▶ Align the antennas in a V-shape.



When using more than one receiver, we recommend connecting remote antennas and, if necessary, using Sennheiser antenna accessories. For more information, visit the ew G3 product page at [www.sennheiser.com](http://www.sennheiser.com).

## Connecting an amplifier/mixing console

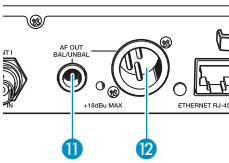

The receiver's 1/4" (6.3 mm) jack socket 11 and the XLR-3M socket 12 are connected in parallel.

- ▶ Use a suitable cable to connect the amplifier and/or the mixing console to the 1/4" (6.3 mm) jack socket 11 and/or the XLR-3M socket 12.
- ▶ Via the operating menu, adjust the audio output level ("AF Out") of the receiver to the input of the amplifier or mixing console (see page 27). The audio output level is adjusted via the operating menu and is common for both sockets.

## Connecting receivers in a network

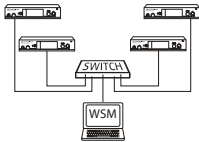

You can connect several receivers in a network. To do so, use the LAN socket 14. The receivers are remote controlled via a PC running the supplied "Wireless Systems Manager" (WSM) software. For information on network operation, refer to the instruction manual of the EM 500 receiver available on the ew G3 product page at [www.sennheiser.com](http://www.sennheiser.com).

## Connecting the mains unit

Only use the supplied mains unit. It is designed for the receiver and ensures safe operation.

To connect the mains unit:

- ▶ Insert the yellow connector of the NT 2-3 mains unit 18 into the yellow socket 16 of the receiver.
- ▶ Pass the cable of the mains unit through the cable grip 15.
- ▶ Slide the supplied country adapter 19 onto the mains unit 18.
- ▶ Plug the mains unit 18 into a wall socket. The **STANDBY** button is backlit in red.

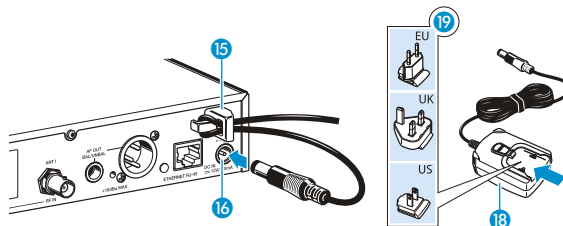

## SK 500 bodypack transmitter

### Inserting the batteries/accupack

For powering the bodypack transmitter, you can either use two 1.5 V AA size batteries or the rechargeable Sennheiser BA 2015 accupack.

- ▶ Push the two catches **11** in the direction of the arrows and open the battery compartment cover **10**.

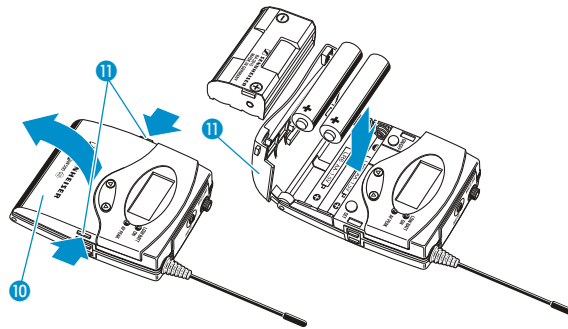

- ▶ Insert the two batteries or the accupack as shown above. Observe correct polarity when inserting the batteries/accupack.
- ▶ Close the battery compartment. The battery compartment cover **10** locks into place with an audible click.

### Charging the accupack

To charge the BA 2015 accupack:

- ▶ Insert the bodypack transmitter into the L 2015 charger (optional accessory).



The L 2015 charger can only charge the combination BA 2015 accupack/bodypack transmitter. Standard batteries (primary cells) or individual rechargeable battery cells cannot be charged.

### Connecting the microphone cable/instrument cable

The audio input is designed for the connection of both condenser microphones and instruments (e.g. guitars). DC powering of the condenser microphones is via the audio input.

- ▶ Use one of the recommended Sennheiser microphones or the optional CI 1 instrument cable.
- ▶ Connect the 3.5 mm jack plug **15** from the Sennheiser microphone or instrument cable to the 3.5 mm jack socket **MIC/LINE 1**.
- ▶ Lock the 3.5 mm jack plug by screwing down the coupling ring **16** of the cable.
- ▶ Via the operating menu, adjust the sensitivity of the microphone/line input.

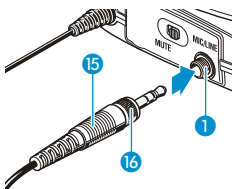



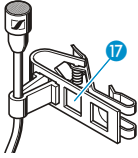

### Attaching and positioning the MKE 2 microphone

- ▶ Use the microphone clip **17** to attach the microphone to clothing (e.g. tie, lapel).

The MKE 2 clip-on microphone has an omni-directional pick-up pattern. It is therefore not necessary to position it precisely.

### Attaching the bodypack transmitter to clothing

You can use the belt clip **18** to attach the bodypack transmitter to clothing (e.g. belt, waist-band).

The belt clip is detachable so that you can also attach the transmitter with the antenna pointing downwards. To do so, withdraw the belt clip **18** from its fixing points and attach it the other way round.

The belt clip **18** is secured so that it cannot slide out of its fixing points accidentally.

To detach the belt clip:

- ▶ Lift one side of the belt clip as shown in the diagram on the right-hand side.
- ▶ Press down the belt clip at one fixing point and pull it out of the transmitter housing.
- ▶ Repeat for the other side.

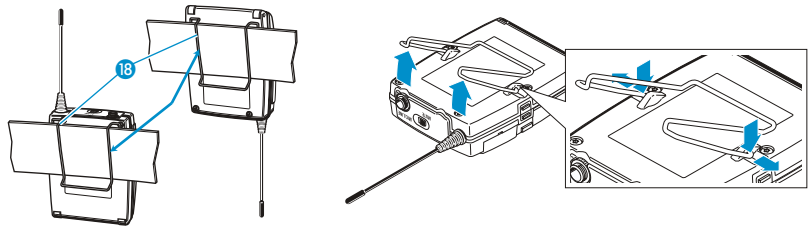

## SKM 500 radio microphone

### Inserting the batteries/accupack

For powering the radio microphone, you can either use two 1.5 V AA size batteries or the rechargeable Sennheiser BA 2015 accupack.

- ▶ Unscrew the lower part of the radio microphone from the radio microphone's body ③ by turning it counterclockwise.



When unscrewing the radio microphone during operation, the muting function is automatically activated. "MUTE" appears on the display panel.

When screwing the lower part of the radio microphone back to the radio microphone's body, the muting is canceled.

- ▶ Slide back the lower part of the radio microphone as far as it will go.
- ▶ Open the battery compartment cover ⑬.
- ▶ Insert the batteries or the BA 2015 accupack as shown on the battery compartment cover. Observe correct polarity when inserting the batteries/accupack.

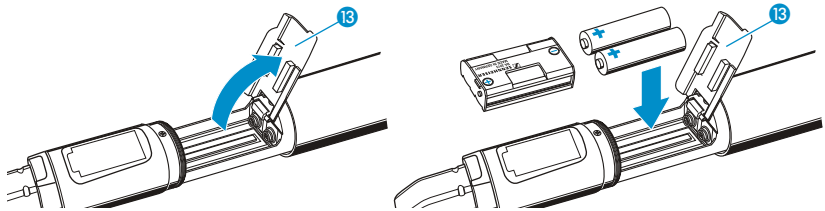
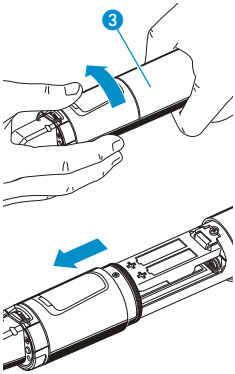

- ▶ Close the battery compartment cover ⑬.
- ▶ Push the battery compartment into the radio microphone's body.
- ▶ Screw the lower part of the radio microphone back to the radio microphone's body ③.

### Charging the accupack

To charge the radio microphone with the inserted BA 2015 accupack (optional accessory):

- ▶ Use the LA 2 charging adapter to insert the radio microphone into the L 2015 charger (both the charger and the charging adapter are available as optional accessories).

### Changing the microphone head

The microphone head is easy to change.

- ▶ Unscrew the microphone head.

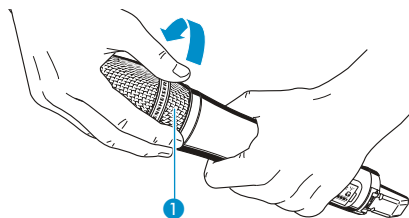



Do not touch the contacts of the radio microphone nor the contacts of the microphone head. The contacts can become dirty or damaged if touched.

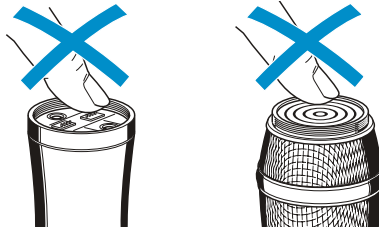

When unscrewing the microphone head during operation, the muting function is automatically activated. "MUTE" appears on the display panel.

When screwing the microphone head back to the radio microphone, the muting function is deactivated.

- ▶ Screw the desired microphone head to the radio microphone.
- ▶ Put the radio microphone back into operation.

### Changing the color-coded protection ring

The color-coded protection ring **8** prevents the multi-function switch **11** from accidental operation. Protection rings in different colors are available as accessories. The protection rings allow you to clearly identify each radio microphone.

- ▶ Remove the color-coded protection ring as shown in the left-hand diagram.
- ▶ Put on a new protection ring as shown in the right-hand diagram.

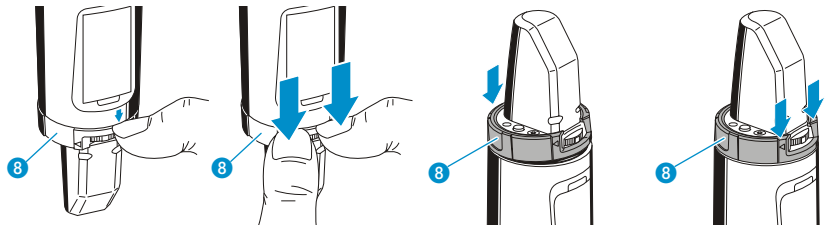

## Using the devices

To establish a transmission link, proceed as follows:

1. Switch the receiver on.
2. Switch a transmitter on.  
The transmission link is established and the display backlighting of the receiver changes from red to orange.

If you cannot establish a transmission link between transmitter and receiver:

- ▶ Make sure that transmitter and receiver are set to the same frequency bank and to the same channel.
- ▶ If necessary, read the chapter "If a problem occurs ..." on page 30.



It is vital to observe the following notes:

- ▶ Make sure that the desired frequencies are listed in the enclosed frequency information sheet.
- ▶ Make sure that the desired frequencies are approved and legal in your country and, if necessary, apply for an operating license.

## Switching the devices on/off

### EM 500 receiver

To switch the receiver on:



- ▶ Briefly press the **STANDBY** button 7. The receiver switches on and the "Receiver Parameters" standard display appears.

To switch the receiver to **standby mode**:

- ▶ If necessary, deactivate the lock mode (see page 22).
- ▶ Keep the **STANDBY** button 7 pressed until "OFF" appears on the display panel.



When in the operating menu, pressing the **STANDBY** button 7 will cancel your entry (ESC function) and return you to the current standard display.

To completely switch the receiver off:

- ▶ Disconnect the receiver from the mains by unplugging the mains unit from the wall socket.

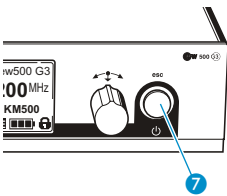

## SK 500 bodypack transmitter

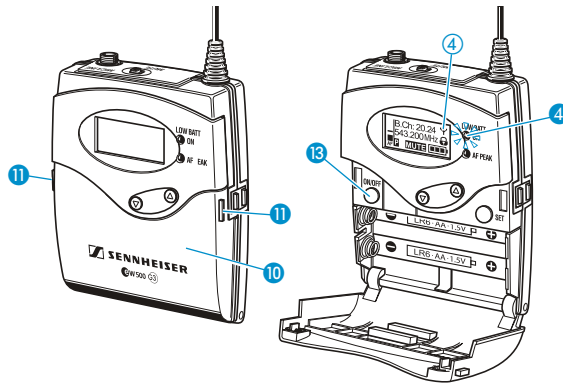

To switch the bodypack transmitter **on** (online operation):

- ▶ Push the two catches **11** and open the battery compartment cover **10**.

**ON/OFF**



- ▶ Briefly press the **ON/OFF** button **13**.

The bodypack transmitter transmits an RF signal. The transmission icon **4** is displayed.

The red **ON** LED **4** lights up and the standard display “Frequency/Name” appears on the display panel.



You can switch the bodypack transmitter on and deactivate the RF signal on switch-on. For more information, see below.

To switch the bodypack transmitter **off**:

- ▶ If necessary, deactivate the lock mode (see page 22).

**ON/OFF**



- ▶ Press the **ON/OFF** button **13** until “OFF” appears on the display panel. The red **ON** LED **4** goes off and the display panel turns off.



When in the operating menu, pressing the **ON/OFF** button **13** will cancel your entry (ESC function) and return you to the current standard display.

To switch the bodypack transmitter **on** and to **deactivate the RF signal on switch-on** (offline operation):



- ▶ Press the **ON/OFF** button **13** until “RF Mute On?” appears on the display panel.



- ▶ Press the **SET** button **7**.

The transmission frequency is displayed but the bodypack transmitter does not transmit an RF signal. The transmission icon **4** is not displayed. When the pilot tone function is activated on both bodypack transmitter and receiver, “RF Mute” appears on the receiver’s display panel.





Use this function to save battery power or to prepare a bodypack transmitter for use during live operation without causing interference to existing transmission links.

To activate the RF signal:



- ▶ Briefly press the ON/OFF button 13.  
"RF Mute Off" appears on the display panel.
- ▶ Press the SET button 7.  
The transmission icon 4 is displayed again.

### SKM 500 radio microphone

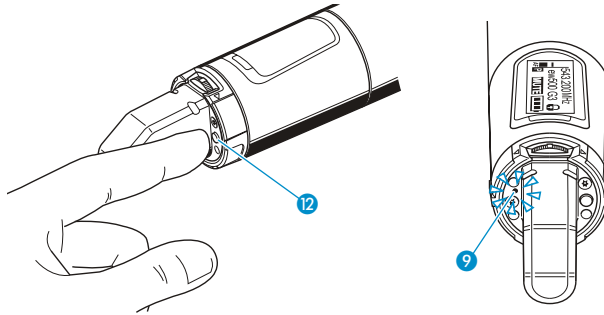

To switch the radio microphone on (online operation):



- ▶ Briefly press the ON/OFF button 12.  
The radio microphone transmits an RF signal. The transmission icon 4 is displayed.  
The red ON LED 9 lights up and the standard display "Frequency/Name" appears on the display panel.



You can switch the radio microphone on and deactivate the RF signal on switch-on. For more information, see below.

To switch the radio microphone off:

- ▶ If necessary, deactivate the lock mode (see page 22).
- ▶ Press the ON/OFF button 12 until "OFF" appears on the display panel. The red ON LED 9 goes off and the display panel turns off.



When in the operating menu, pressing the ON/OFF button 12 will cancel your entry (ESC function) and return you to the current standard display.

To switch the radio microphone on and to deactivate the RF signal on switch-on (offline operation):



- ▶ Press the ON/OFF button 12 until "RF Mute On?" appears on the display panel.



- ▶ Press the multi-function switch ①.  
The transmission frequency is displayed but the radio microphone does not transmit an RF signal. The transmission icon ④ is not displayed. When the pilot tone function is activated on both radio microphone and receiver, "RF Mute" appears on the receiver's display panel.



Use this function to save battery power or to prepare a radio microphone for use during live operation without causing interference to existing transmission links.

To **activate** the RF signal:



- ▶ Briefly press the ON/OFF button ⑫.  
"RF Mute Off" appears on the display panel.



- ▶ Press the multi-function switch ①.  
The transmission icon ④ is displayed again.

## Synchronizing a transmitter with the receiver

You can synchronize a suitable transmitter of the ew 500 G3 series with the receiver. During synchronization, the following parameters are transferred to the transmitter:

Setting	Transferred parameters
"Frequency Preset"	Currently set frequency
"Name"	Freely selectable name currently set on the receiver
"Pilot Tone"	Current pilot tone setting of the receiver ("Inactive"/"Active")

To transfer the parameters:

- ▶ Switch the transmitter and the receiver on.
- ▶ Press the **sync** button ③ on the receiver.  
"Sync" appears on the display panel of the receiver.
- ▶ Place the infra-red interface of the transmitter (see page 8 and page 10) in front of the infra-red interface of the receiver ④.  
The parameters are transferred to the transmitter. When the transfer is completed, "✓" appears on the display panel. The receiver then switches back to the current standard display.

To cancel the transfer:

- ▶ Press the **STANDBY** button on the receiver.  
"X" appears on the display panel of the receiver. "X" also appears if:
  - no transmitter was found or the transmitter is not compatible,
  - no transmitter was found and the synchronization process was canceled after 30 seconds,
  - you canceled the transfer.

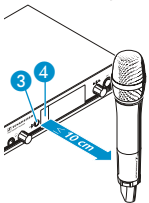
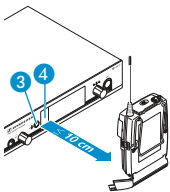

Via the "Sync Settings" submenu, you can adjust the parameters to be transferred to the transmitters (see page 27).

## Deactivating the lock mode temporarily

You can activate or deactivate the automatic lock mode via the “Auto Lock” menu item (see page 26). If the lock mode is activated, you have to temporarily deactivate it in order to be able to operate the devices:

### EM 500



▶ Turn the jog dial.  
“Unlock?” appears on the display panel.



▶ Press the jog dial.  
The lock mode is temporarily deactivated (see below).

### SK 500



▶ Press the rocker button.  
“Unlock?” appears on the display panel.



▶ Press the SET button.  
The lock mode is temporarily deactivated (see below).

### SKM 500



▶ Move the multi-function switch upwards/downwards.  
“Unlock?” appears on the display panel.



▶ Press the multi-function switch.  
The lock mode is temporarily deactivated (see below).

How you are using the devices determines how long the lock mode remains deactivated:

#### When in the operating menu

The lock mode is deactivated as long as you are working with the operating menu.

#### When one of the standard displays is shown

The lock mode is automatically activated after 10 seconds.

Prior to this, the lock mode icon flashes, indicating that the lock mode is being activated.



## Muting the audio signal or deactivating the RF signal

### EM 500

To **mute** the audio signal:



- ▶ When one of the standard displays is shown on the display panel, press the **STANDBY** button.  
"RX Mute On?" appears on the display panel.



- ▶ Press the jog dial.  
The audio signal is muted. "RX Mute" appears in alternation with the current standard display.

To **unmute** the audio signal:



- ▶ Press the **STANDBY** button.  
"RX Mute Off?" appears on the display panel.



- ▶ Press the jog dial.  
The muting is canceled.

### SK 500

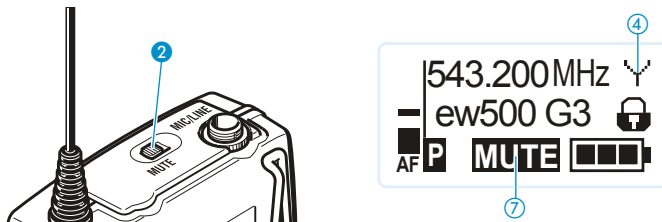

The **MUTE** switch **2** allows you to mute the audio signal or to deactivate the RF signal. Via the "Mute Mode" menu item, you can set the desired function of the **MUTE** switch **2**:

Setting	Slide the MUTE switch <b>2</b> ...	Function
"Disabled"	... to the left (position <b>MUTE</b> )	None
"RF On/Off"	... to the left (position <b>MUTE</b> )	Deactivates the RF signal (offline operation)
	... to the right	Activates the RF signal (online operation)
"AF On/Off"	... to the left (position <b>MUTE</b> )	Mutes the audio signal
	... to the right	Unmutes the audio signal

- ▶ From the "Mute Mode" menu item, select the desired setting (see page 28).
- ▶ Exit the operating menu.
- ▶ Slide the **MUTE** switch **2** to the left, to the position **MUTE**.  
The bodypack transmitter reacts as indicated in the table.

The current state of the muting function or the RF signal is displayed on the display panel of the bodypack transmitter. An additional display appears on the receiver's display panel when the pilot tone function is activated on both bodypack transmitter and receiver and, in addition, this display has been activated via the "Warnings" menu item on the receiver (see page 27).

**Audio signal is muted**

Transmitter's display panel:	"MUTE" ⑦ is displayed
------------------------------	-----------------------

Receiver's display panel:	"TX Mute" is displayed*
---------------------------	-------------------------

\* only when activated on the receiver (see above)

**Audio signal is activated (muting is deactivated)**

Transmitter's display panel:	"MUTE" ⑦ is not displayed
------------------------------	---------------------------

Receiver's display panel:	"TX Mute" is not displayed
---------------------------	----------------------------

**RF signal is deactivated**

Transmitter's display panel:	Transmission icon ④ is not displayed
------------------------------	--------------------------------------

Receiver's display panel:	"RF Mute" is displayed*
---------------------------	-------------------------

\* only when activated on the receiver (see above)

**RF signal is activated**

Transmitter's display panel:	Transmission icon ④ is displayed
------------------------------	----------------------------------

Receiver's display panel:	"RF Mute" is not displayed
---------------------------	----------------------------



You can also deactivate the RF signal on switch-on. For more information, refer to the chapter "Switching the devices on/off" on page 18.

Using the **ON/OFF** button, you can also activate/deactivate the RF signal during operation. To do so, briefly press the **ON/OFF** button and proceed as described on page 19.

**SKM 500**

You can deactivate the RF signal on switch-on. For more information, refer to the chapter "Switching the devices on/off" on page 20.

To deactivate the RF signal during operation:



- ▶ When one of the standard displays is shown on the display panel, press the **ON/OFF** button.  
"RX Mute On?" appears on the display panel.
- ▶ Proceed as described on page 20.

## Selecting a standard display

### EM 500



▶ Press the jog dial to select a standard display:

Contents of the display	Selectable standard display
	<p><b>“Receiver Parameters”</b> appears after switch-on of the receiver and displays the receiver parameters (see page 5).</p>
	<p><b>“Transmitter Parameters”</b> (transmitter type/microphone) displays the microphone head (SKM only) and the transmitter type.</p>
	<p><b>“Soundcheck”</b> (display with additional function) displays the signal quality within the transmission area.</p>
	<p><b>“Guitar Tuner”</b> (display with additional function) displays the guitar tuner*.</p>

\* The **“Guitar Tuner”** standard display is deactivated upon delivery. To show this standard display, you have to activate it (see page 27).



Information on the soundcheck function and the guitar tuner function can be found in the instruction manual of the EM 500 receiver available on the ew G3 product page at [www.sennheiser.com](http://www.sennheiser.com).

### SK 500 and SKM 500

To select a standard display:

SK 500	SKM 500
▶ Press the rocker button.	▶ Move the multi-function switch.

You can select the following standard displays: **“Frequency/Name”**, **“Channel/Frequency”**, **“Channel/Name”**.

## Overview of the operating menus



For more detailed information on the operating menus, refer to the individual instruction manuals of the devices. These instruction manuals can be downloaded from the respective product pages at [www.sennheiser.com](http://www.sennheiser.com).

### EM 500

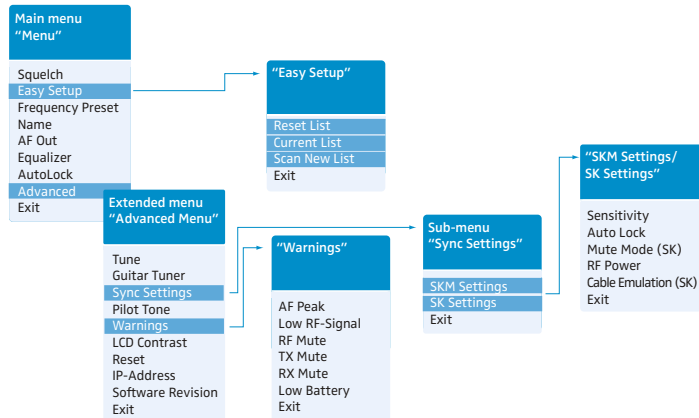

When one of the standard displays is shown on the display panel, you can get into the main menu by pressing the jog dial **6**. The extended menu "Advanced Menu" and the submenus can be accessed via the corresponding menu items.

Display	Function of the menu item
<b>Main menu "Menu"</b>	
Squelch	<p>Adjusts the squelch threshold, adjustment range: 5 to 25 dB<math>\mu</math>V in 2-dB steps, can be switched off</p> <p>Special function (for servicing purposes only): With the jog dial <b>6</b> set to the "5 dB" setting, you switch the squelch off by turning the jog dial to the left and keeping it in this position. If you then turn the jog dial to the right, you switch the squelch on again.</p> <hr/> <p><b>CAUTION!</b></p>  <p><b>Danger of hearing damage and material damage!</b></p> <p>If you switch the squelch off or adjust the squelch threshold to a very low value, loud hissing noise can occur in the receiver.</p> <p>The hissing noise can be loud enough to cause hearing damage or overload the loudspeakers of your system!</p> <ul style="list-style-type: none"> <li>▶ Always make sure that the squelch is switched on (see above).</li> <li>▶ Before adjusting the squelch threshold, set the volume of the audio output level to the minimum.</li> <li>▶ Never change the squelch threshold during a live transmission.</li> </ul>

Display	Function of the menu item
Easy Setup	Scans for unused frequency presets, releases and selects frequency presets
Frequency Preset	Changes the frequency bank and the channel
Name	Enters a freely selectable name
AF Out	Adjusts the audio output level Adjustment range: -24 dB to +24 dB, adjustable in 3-dB steps, 6 dB gain reserve Special function "gain reserve": ▶ When you have adjusted a level of +18 dB, turn the jog dial <b>6</b> to the right and keep it in this position until the next higher value appears.
Equalizer	Changes the frequency response of the output signal
Auto Lock	Activates/deactivates the automatic lock mode
Advanced	Calls up the extended menu "Advanced Menu"
Exit	Exits the operating menu and returns to the current standard display

### "Easy Setup"

Reset List	Releases all locked frequency presets and selects an unused frequency preset
Current List	Selects an unused frequency preset
Scan New List	Scans for unused receiving frequencies (frequency preset scan)
Exit	Exits the submenu "Easy Setup" and returns to the main menu

### Extended menu "Advanced Menu"

Tune	Sets the receiving frequencies for the frequency banks "U1" to "U6" Special function: Sets a channel and a receiving frequency for the frequency banks "U1" to "U6": ▶ Select this menu item and call it up by pressing the jog dial <b>6</b> until the channel selection appears.
Sync Settings	Activates/deactivates the parameters to be transferred to the transmitters
Guitar Tuner	Selects the mode of the guitar tuner function
Pilot Tone	Activates/deactivates the pilot tone evaluation
Warnings	Activates/deactivates the warning messages
LCD Contrast	Adjusts the contrast of the display panel
Reset	Resets the receiver
IP-Address	Adjusts the IP address of the receiver
Software Revision	Displays the current software revision
Exit	Exits the extended menu "Advanced Menu" and returns to the main menu

### Submenu "Sync Settings"

SKM Settings	Activates/deactivates the parameters to be transferred to the SKM radio microphones
SK Settings	Activates/deactivates the parameters to be transferred to the SK bodypack transmitters
Exit	Exits the submenu "Sync Settings" and returns to the extended menu "Advanced Menu"

### "SK Settings" / "SKM Settings"

Here you can activate/deactivate the transfer of the following transmitter parameters: Sensitivity, Auto Lock, Mute Mode (SK), RF Power and Cable Emulation (SK) (see page 28)

### "Warnings"

	Activates/deactivates warnings (color change and warning messages):
AF-Peak	Audio overmodulation
Low RF-Signal	RF signal is weak
RF-Mute	RF signal is too weak or no RF signal

Display	Function of the menu item
TX-Mute	<ul style="list-style-type: none"> <li>• Transmitter is muted or</li> <li>• no pilot tone</li> </ul>
RX-Mute	Receiver is muted
Low Battery	Charge status of the transmitter battery/the BA 2015 accupack is critical
Exit	Exits the submenu "Warnings" and returns to the extended menu "Advanced Menu"

### SK 500 and SKM 500

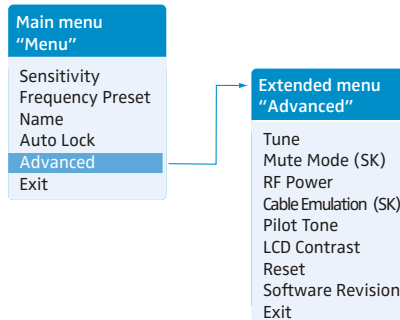

Display	Meaning
<b>Main menu "Menu"</b>	
Sensitivity	Adjusts the sensitivity "AF"
Frequency Preset*	Changes the frequency bank and the channel
Name*	Enters a freely selectable name
Auto Lock	Activates/deactivates the automatic lock mode
Advanced	Calls up the extended menu "Advanced Menu"
Exit	Exits the operating menu and returns to the current standard display

#### Extended menu "Advanced Menu"

Tune	Sets the transmission frequencies for the frequency banks "U1" to "U6" Special function: Sets a channel and a transmission frequency for the frequency banks "U1" to "U6": ► Select this menu item and call it up by pressing the <b>SET</b> button (SK)/the multi-function switch (SKM) until the channel selection appears.
Mute Mode (SK)	Sets the mode for the <b>MUTE</b> switch
RF Power	Adjusts the transmission power
Cable Emulation (SK)	Emulates guitar cable lengths/guitar cable capacities
Pilot Tone*	Activates/deactivates the pilot tone transmission
LCD Contrast	Adjusts the contrast of the display panel
Reset	Resets the bodypack transmitter/radio microphone
Software Revision	Displays the current software revision
Exit	Exits the extended menu "Advanced Menu" and returns to the main menu

\* For information on the synchronization of transmitters with receivers, refer to page 21.

## Cleaning the devices

### CAUTION!



#### Liquids can damage the electronics of the devices!

Liquids entering the housing of the devices can cause a short-circuit and damage the electronics.

- ▶ Keep all liquids away from the devices.

### EM 500

- ▶ Before cleaning, disconnect the device from the mains.
- ▶ Use a slightly damp cloth to clean the receiver from time to time. Do not use any solvents or cleansing agents.

### SK 500

- ▶ Use a slightly damp cloth to clean the bodypack transmitter from time to time. Do not use any solvents or cleansing agents.

### SKM 500

- ▶ Use a slightly damp cloth to clean the bodypack transmitter from time to time. Do not use any solvents or cleansing agents.

To clean the radio microphone's sound inlet basket (MMD 835-1, MMD 845-1, MMD 935-1, MMD 945-1, MME 865-1):

- ▶ Unscrew the upper sound inlet basket from the microphone head by turning it counter-clockwise.

### CAUTION!

#### Liquids can damage the microphone head!

Liquids can damage the microphone head.

- ▶ Only clean the upper sound inlet basket.

- ▶ Remove the foam insert.
- ▶ There are two ways to clean the sound inlet basket:
  - Use a slightly damp cloth to clean the upper sound inlet basket from the inside and outside
  - or scrub with a brush and rinse with clear water.
- ▶ If necessary, clean the foam insert with a mild detergent or replace the foam insert.
- ▶ Dry the upper sound inlet basket.
- ▶ Dry the foam insert.
- ▶ Reinsert the foam insert.
- ▶ Replace the sound inlet basket on the microphone head and screw it tight.

You should also clean the contact rings of the microphone head from time to time:

- ▶ Wipe the contact rings of the microphone head with a dry cloth.



For information on cleaning the MMK 965-1 microphone head, refer to its instruction manual.

## If a problem occurs ...

### EM 500

Problem	Possible cause	Possible solution
Receiver cannot be operated, "Locked" appears on the display panel	Lock mode is activated	Deactivate the lock mode (see page 22).
No operation indication	No mains connection	Check the connections of the mains unit.
No RF signal	Transmitter and receiver are not on the same channel	Set the transmitter and receiver to the same channel. To do so, use the synchronization function (see page 21).
	Transmitter is out of range	Check the squelch threshold setting (see page 26). Reduce the distance between transmitter and receiving antennas.
RF signal available, no audio signal, "MUTE" appears on the display panel	If "TX Mute" additionally appears on the display panel: transmitter is muted ("MUTE") or transmitter doesn't transmit a pilot tone	Cancel the muting (see page 23). Switch the pilot tone transmission on the transmitter on (see page 28). Switch the pilot tone evaluation on the receiver off (see page 27).
	Receiver's squelch threshold is adjusted too high	Reduce the squelch threshold (see page 26). Reposition the antennas.
Audio signal has a high level of background noise	Transmitter sensitivity is adjusted too low/high	Adjust the transmitter sensitivity correctly ("Sensitivity", see page 28).
Audio signal is distorted	Transmitter sensitivity is adjusted too high	Adjust the transmitter sensitivity correctly ("Sensitivity", see page 28).
	Receiver's audio output level is adjusted too high	Reduce the audio output level ("AF Out", see page 27).
No access to a certain channel	During scanning, an RF signal has been detected on this channel and the channel has been locked	Set the transmitter operating on this channel to a different channel and redo the frequency preset scan (see page 27).
	During scanning, a transmitter of your system operating on this channel has not been switched off	Switch the transmitter off and redo the frequency preset scan (see page 27).
None of the diversity displays I or II appears on the display panel	Receiver's squelch threshold is adjusted too high	Reduce the squelch threshold (see page 26).
	Transmitter's RF signal is too weak	Increase the transmission power of the transmitter. Reduce the distance between transmitter and receiver.
	Antennas are not connected correctly	Check the antenna cables or the antennas.
During the soundcheck, only one diversity display (I or II) appears on the display panel	One of the antennas is not connected correctly	Check the antenna cable or the antenna.
	Antennas are not optimally positioned	Reposition the antennas.



## SK 500 and SKM 500

Problem	Possible cause	Possible solution
Devices cannot be operated, "Locked" appears on the display panel	Lock mode is activated	Deactivate the lock mode (see page 22).
No operation indication	Batteries are flat or accupack is flat	Replace the batteries or recharge the accupack (see page 16).
No RF signal at the receiver	Bodypack transmitter/radio microphone and receiver are not on the same channel	Synchronize the bodypack transmitter/radio microphone with the receiver (see page 21). Set the bodypack transmitter/radio microphone to the same channel as the receiver.
	Bodypack transmitter/radio microphone is out of range	Check the squelch threshold setting on the receiver. Reduce the distance between bodypack transmitter/radio microphone and receiving antenna.
	RF signal is deactivated ("RF Mute")	Activate the RF signal (see page 24).
RF signal available, no audio signal, "MUTE" appears on the display panel of the receiver	Bodypack transmitter/radio microphone is muted (MUTE)	Cancel the muting (see page 23).
	Receiver's squelch threshold is adjusted too high	Reduce the squelch threshold setting on the receiver.
	Bodypack transmitter/radio microphone doesn't transmit a pilot tone	Activate or deactivate the pilot tone transmission (see page 28).
Audio signal has a high level of background noise or is distorted	Bodypack transmitter's/radio microphone's sensitivity is adjusted too low/too high	Adjust the input sensitivity (see page 28).

If a problem occurs that is not listed in the above table or if the problem cannot be solved with the proposed solutions, please contact your local Sennheiser partner for assistance. To find a Sennheiser partner in your country, search at [www.sennheiser.com](http://www.sennheiser.com) under "Service & Support".

# Specifications

## EM 500

### RF characteristics

Modulation	wideband FM
Receiving frequency ranges	516–558, 566–608, 626–668, 734–776, 780–822, 823–865 MHz (A to E, G, see page 4)
Receiving frequencies	1,680 frequencies, tuneable in steps of 25 kHz 20 frequency banks, each with up to 32 factory-preset channels, intermodulation-free 6 frequency banks, each with up to 32 user programmable channels
Switching bandwidth	42 MHz
Nominal/peak deviation	$\pm 24$ kHz/ $\pm 48$ kHz
Receiver principle	true diversity
Sensitivity (with HDX, peak deviation)	$< 2 \mu\text{V}$ for 52 dBA <sub>rms S/N</sub>
Adjacent channel rejection	typ. $\geq 75$ dB
Intermodulation attenuation	typ. $\geq 70$ dB
Blocking	$\geq 75$ dB
Squelch	Off, 5 to 25 dB $\mu\text{V}$ in steps of 2 dB
Pilot tone squelch	can be switched off
Antenna inputs	2 BNC sockets

### AF characteristics

Compander system	Sennheiser HDX
EQ presets (switchable, affect the line and monitor outputs):	
Preset 1: "Flat"	
Preset 2: "Low Cut"	
Preset 3: "Low Cut/High Boost"	
Preset 3: "High Boost"	
S/N ratio (1 mV, peak deviation)	$-3$ dB at 180 Hz $-3$ dB at 180 Hz $+6$ dB at 10 kHz $+6$ dB at 10 kHz $\geq 115$ dBA
THD	$\leq 0.9\%$
AF output voltage (at peak deviation, 1 kHz AF)	$\frac{1}{4}$ " (6.3 mm) jack socket (unbalanced): $+12$ dBu XLR socket (balanced): $+18$ dBu
Adjustment range of audio output level	$48$ dB (in steps of 3 dB) $+6$ dB gain reserve

### Overall device

Temperature range	$-10^\circ\text{C}$ to $+55^\circ\text{C}$
Power supply	12 V ===
Current consumption	350 mA
Dimensions	approx. 202 x 212 x 43 mm
Weight	approx. 980 g

**In compliance with (EM)**

Europe:

CE	EMC	EN 301489-1/-9
	Radio	EN 300422-1/-2
	Safety	EN 60065

USA:

FC	47 CFR 15 subpart B
----	---------------------

**Approved by**

Canada:

Industry Canada RSS 210, IC: 2099A-G3SKMEM

**Mains unit**

Input voltage  
Power/current consumption  
Output voltage  
Secondary output current  
Temperature range

100 to 240 V~, 50/60 Hz
max. 120 mA
12 V===
400 mA
-10°C to +40°C

**In compliance with**

Europe:

CE	EMC	EN 55022, EN 55024, EN 55014-1/-2
	Safety	EN 60065

USA:

FC	47 CFR 15 subpart B
	ICES 003

Canada:

Certified by cCSAus KL, 60065, CSA.

For accessories and information on connector assignment, visit the ew G3 product page at [www.sennheiser.com](http://www.sennheiser.com).**SK 500 and SKM 500****RF characteristics**

Modulation  
Frequency ranges  
Transmission frequencies  
  
Switching bandwidth  
Nominal/peak deviation  
Frequency stability  
RF output power at 50 Ω  
Pilot tone squelch

wideband FM
516–558, 566–608, 626–668, 734–776, 780–822, 823–865 MHz (A to E, G, see page 4)
1,680 frequencies, tuneable in steps of 25 kHz
20 frequency banks, each with up to 32 factory-preset channels, intermodulation-free
6 frequency banks, each with up to 32 user program-mable channels
42 MHz
±24 kHz/±48 kHz
≤±15 ppm
typ. 10/30 mW, switchable
can be switched off

### AF characteristics

Compander system  
 AF frequency response  
     SK  
     SKM  
 S/N ratio (1 mV, peak deviation)  
 THD  
 Max. input voltage (SK) microphone/line  
 Input impedance (SK) microphone/line  
 Input capacitance (SK)  
 Adjustment range of input sensitivity

### Overall device

Temperature range  
 Power supply  
  
 Nominal voltage  
 Current consumption:  
     at nominal voltage  
     with switched-off transmitter  
 Operating time  
 Dimensions  
  
 Weight (incl. batteries)

### In compliance with (SK and SKM)

Europe:

### Approved by (SK)

Canada:

USA:

### Approved by (SKM)

Canada:

USA:

### Sennheiser HDX

microphone: 80–18,000 Hz  
 line: 25–18,000 Hz  
 80–18,000 Hz  
 $\geq 110$  dBA  
 $\leq 0.9\%$   
 $3 V_{rms}$   
 40 k $\Omega$  unbalanced/1 M $\Omega$   
 switchable  
 SK: 60 dB, adjustable in steps of 3 dB  
 SKM: 48 dB, adjustable in steps of 6 dB

–10°C to +55°C  
 2 AA size batteries, 1.5 V  
 or BA 2015 accupack  
 2.4 V —=

typ. 180 mA (30 mW)  
 $\leq 25$   $\mu$ A  
 typ. 8 hrs  
 SK: approx. 82 x 64 x 24 mm  
 SKM: approx.  $\varnothing$  50 x 265 mm  
 SK: approx. 160 g  
 SKM: approx. 450 g

CE	EMC	EN 301489-1/-9
	Radio	EN 300422-1/-2
	Safety	EN 60065, EN 62311 (SAR)

Industry Canada RSS 210, IC 2099A-G3SK  
 limited to 806 MHz  
 FCC-Part 74, FCC-ID: DMO G3SK  
 limited to 698 MHz

Industry Canada RSS 210, IC: 2099A-G3SKMEM  
 limited to 806 MHz  
 FCC-Part 74, FCC-ID: DMO G3SKMEM  
 limited to 698 MHz

## Microphones (SK 500)

	<b>MKE 2</b>
Microphone type	condenser
Sensitivity	5 mV/Pa
Pick-up pattern	omni-directional
Max. SPL	142 dB SPL

## Microphone heads (SKM 500)

	<b>MMD 935-1</b>	<b>MMD 945-1</b>	<b>MMK 965-1</b>
Radio microphone type	dynamic	dynamic	Externally polarized dual diaphragm condenser microphone
Sensitivity	2.5 mV/Pa	1.8 mV/Pa	7 mV/Pa / 2.3 mV/Pa
Pick-up pattern	cardioid	super-cardioid	cardioid/super-cardioid, switchable
Max. SPL	154 dB SPL	154 dB SPL	142 dB SPL / 152 dB SPL

### Polar diagrams and frequency response curves of the microphone heads (SKM 500)

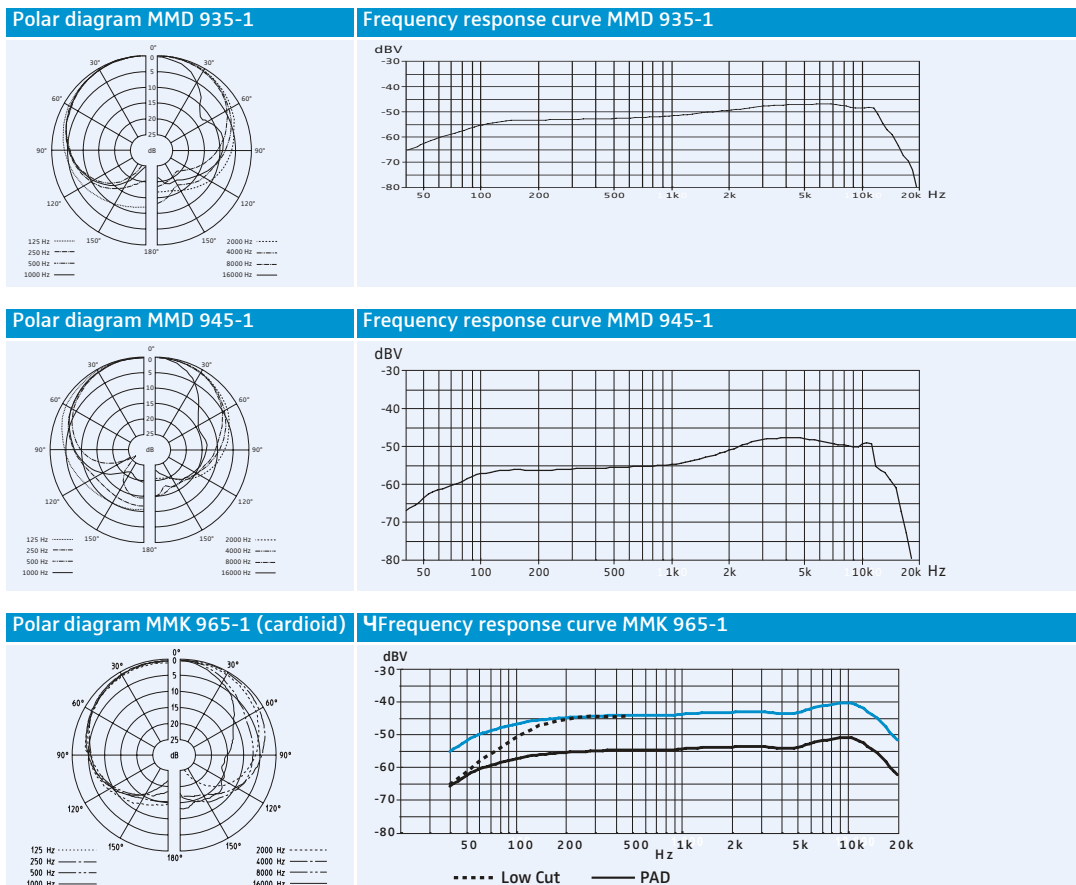

Polar diagram MMK 965-1  
(super-cardioid)

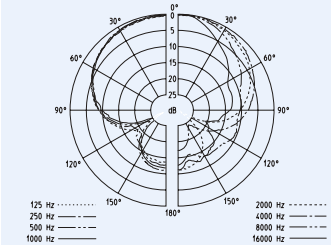

Frequency response curve MMK 965-1

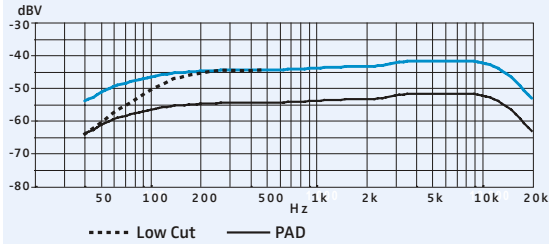

## Manufacturer Declarations

### Warranty

Sennheiser electronic GmbH & Co. KG gives a warranty of 24 months on this product.

For the current warranty conditions, please visit our web site at [www.sennheiser.com](http://www.sennheiser.com) or contact your Sennheiser partner.

### In compliance with the following requirements

- RoHS Directive (2002/95/EU)
- WEEE Directive (2002/96/EU)



Please dispose of these products at the end of their operational lifetime by taking them to your local collection point or recycling center for such equipment.

- Battery Directive (2006/66/EU)



The supplied batteries or rechargeable batteries of the transmitters can be recycled. Please dispose of them as special waste or return them to your specialist dealer. In order to protect the environment, only dispose of exhausted batteries.

### CE Declaration of Conformity

- EM 500: **CE 0682** SK / SKM 500: **CE 0682** Ⓞ
- R&TTE Directive (1999/5/EU), EMC Directive (2004/108/EU), Low Voltage Directive (2006/95/EU)

The declarations are available at [www.sennheiser.com](http://www.sennheiser.com).

Before putting the devices into operation, please observe the respective country-specific regulations.

## Statements regarding FCC and Industry Canada

These devices comply with Part 15 of the FCC Rules and with RSS-210 of Industry Canada. Operation is subject to the following two conditions: (1) these devices may not cause harmful interference, and (2) these devices must accept any interference received, including interference that may cause undesired operation.

This equipment has been tested and found to comply with the limits for a Class B digital device, pursuant to Part 15 of the FCC Rules. These limits are designed to provide reasonable protection against harmful interference in a residential installation. This equipment generates, uses and can radiate radio frequency energy and, if not installed and used in accordance with the instructions, may cause harmful interference to radio communications. However, there is no guarantee that interference will not occur in a particular installation. If this equipment does cause harmful interference to radio or television reception, which can be determined by turning the equipment off and on, the user is encouraged to try to correct the interference by one or more of the following measures:

- Reorient or relocate the receiving antenna.
- Increase the separation between the equipment and receiver.
- Connect the equipment into an outlet on a circuit different from that to which the receiver is connected.
- Consult the dealer or an experienced radio/TV technician for help.

These class B digital devices comply with the Canadian ICES-003.

Changes or modifications made to this equipment not expressly approved by Sennheiser electronic Corp. may void the FCC authorization to operate this equipment.

Before putting the devices into operation, please observe the respective country-specific regulations!







Sennheiser electronic GmbH & Co. KG  
Am Labor 1, 30900 Wedemark, Germany  
[www.sennheiser.com](http://www.sennheiser.com)

Printed in Germany  
Publ. 01/09  
529662/A01