



MK 4

High quality
studio microphone

Instruction manual

 **SENNHEISER**

Contents

Important safety information	2
The MK 4 microphone	4
Delivery includes	5
Putting the MK 4 into operation	6
Mounting the microphone	6
Orienting the microphone	6
Connecting the microphone	8
Using the microphone	9
Cleaning and maintaining the MK 4	11
Specifications	12
Polar diagram	13
Frequency response curve	13
If a problem occurs	14
Manufacturer Declarations	16

DE

EN

FR

IT

ES

NL

RU

ZH

Important safety information

- Please read this instruction manual carefully and completely before using the product.
- Make this instruction manual easily accessible to all users at all times.
- Always include this instruction manual when passing the product on to third parties.

Before operation

- Never open the housing of the product. If products are opened by customers in breach of this instruction, the warranty becomes null and void.

During operation

- Liquids entering the product can short-circuit the electronics or damage the mechanics. Keep all liquids away from the product.
- Solvents or cleansing agents can damage the surface of the product. Only use a soft, slightly damp cloth to clean the product.
- Do not expose the product to extreme temperatures.

After operation

- Use the product with care and store it in a clean, dust-free environment.

Intended use

Intended use includes:

- having read this instruction manual, especially the chapter “Important safety information”,
- using the product within the operating conditions and limitations described in this instruction manual.

“Improper use” means using the product other than as described in this instruction manual, or under operating conditions which differ from those described herein.



The MK 4 microphone

The MK 4 is a large diaphragm true condenser studio microphone for very detailed, professional studio recordings. Its outstanding sound quality, easy handling and excellent value-for-money ratio make the MK 4 also ideal for project studios and home recording applications.

Features

- Large diaphragm capsule (1") in true condenser design, internally shock-mounted for low handling noise
- 24-carat gold-plated diaphragm
- Rugged metal housing
- Designed for studio and stage use
- Low inherent self-noise and high maximum sound pressure level
- Made in Germany

Areas of application

- Speech/vocals
- Acoustic guitars
- Guitar amplifiers
- Grand piano
- Strings
- Wind instruments
- Drums and percussion

Delivery includes



MK 4 microphone



MZQ 4 microphone clamp



Pouch



Instruction manual

Putting the MK 4 into operation

Mounting the microphone

- 1 Screw the MZQ 4 microphone clamp to a solid and sturdy stand.
- 2 Place the microphone from above into the microphone clamp and screw it tight.

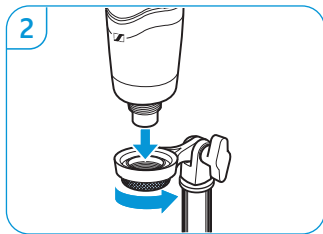
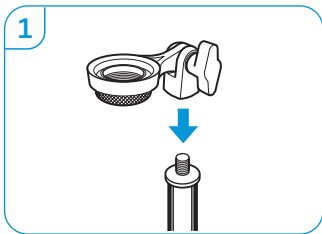

Orienting the microphone

- ▶ To orient the microphone, **always** loosen the wing screw.

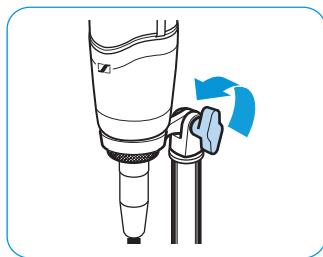

To suppress structure-borne noise, you can optionally use the MKS 4 shock mount which is available as a Sennheiser accessory.

- ▶ Place the microphone from above into the inner shock mount cage and screw it tight.
- ▶ To orient the microphone, **always** loosen the wing screw.

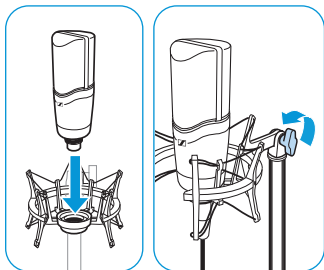

Connecting the microphone

CAUTION! Damage to the product due to an unsuitable power supply!

An unsuitable power supply can cause damage to the product.

- ▶ Only connect the product to microphone inputs or power supply units which provide 48 V phantom powering as per IEC 61938.

- ▶ Use a microphone cable with XLR-3 female connector to connect the microphone's XLR-3 male connector to the microphone preamplifier (48 ± 4 V phantom powering as per IEC 61938, at least 3.5 mA per channel).

Pin assignment of the XLR-3 connector

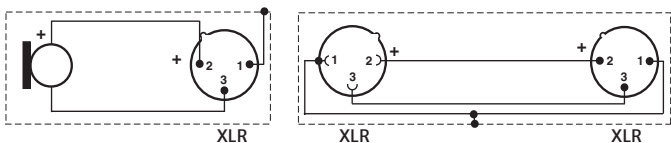

Using the microphone

- ▶ Orient the microphone towards the mouth or sound source.

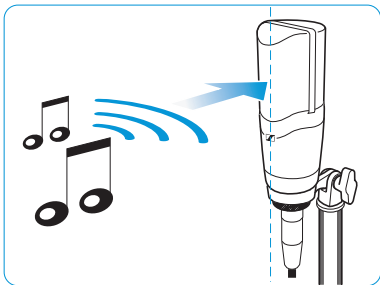

- i** If sibilance occurs, position the microphone slightly to the side and not directly in front of the mouth.

To eliminate disturbing noise as far as possible:

- ▶ Make sure that there is no disturbing noise source (e.g. a PC fan) in the sound inlet area of the microphone.

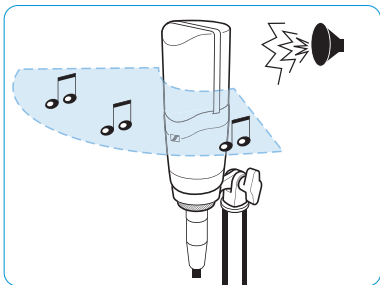

Application examples

Popshield (e.g. Sennheiser MZP 40):

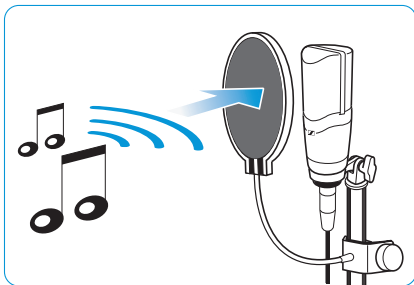

Windshield (e.g. Sennheiser MKW 4):

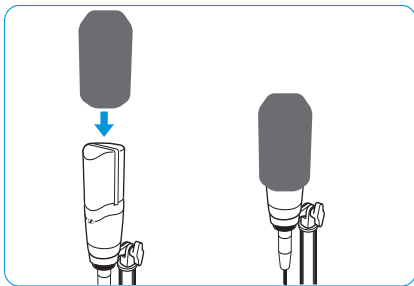

The windshield changes the sound only slightly, but attenuates wind noise by approx. 10 dB.

Cleaning and maintaining the MK 4

CAUTION

Damage to the product due to liquids!

Liquids entering the product can short-circuit the electronics or damage the mechanics. Solvents or cleansing agents can damage the surface of the product.

- ▶ Keep all liquids away from the product.

- ▶ Only use a soft, slightly damp cloth to clean the product.

When not using the microphone for extended periods of time:

- ▶ Store the microphone in a dry, clean and dust-free place at room temperature.
- ▶ For this, use the supplied pouch or a lint-free, air-permeable packing material.



Accessories are available from your Sennheiser partner. A list of suitable accessories can be found on our website at www.sennheiser.com > Service & Support.

Specifications

Transducer principle	externally polarized condenser microphone
Diameter of diaphragm	25.4 mm / 1"
Acoustic operating principle	pressure gradient transducer
Pick-up pattern	cardioid
Frequency response	20 Hz to 20 kHz
Sensitivity	25 mV/Pa
Max. SPL	140 dB
Equivalent noise level	10 dB(A) (DIN IEC 651) 20 dB (CCIR 468-3)
Dynamic range	130 dB
Nominal impedance	approx. 50 Ω
Min. terminating impedance	1 k Ω
Power supply	phantom powering 48 V (P48)
Current consumption	3.1 mA
Diameter	57 mm
Length	160 mm
Weight	485 g
Operating temperature	0°C to +40°C
Storage temperature	-20°C to +70°C

Polar diagram

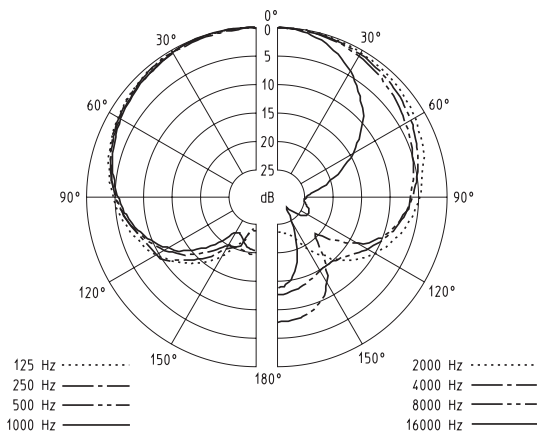

Frequency response curve

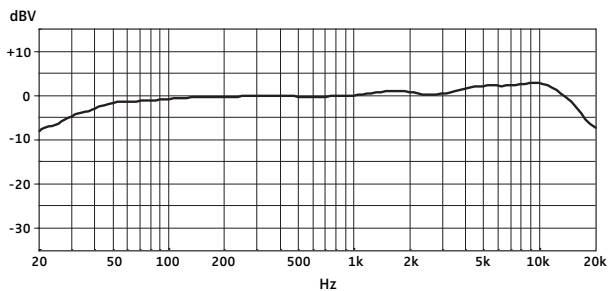

If a problem occurs ...

Problem	Possible cause	Possible solution
No function	The phantom power on the mixing console or phantom power device is not switched on.	Check the corresponding setting on the channel strip.
	The phantom power device is not connected to the mains or no battery is inserted.	Check the mains connection or the battery of the phantom power device.
No signal transmission	The microphone is connected to the wrong microphone amplifier input of the subsequent device.	Check the signal path.
		If necessary, activate the appropriate input on the corresponding channel strip of the mixing console.

Problem	Possible cause	Possible solution
Sound distorted	Wrong input sensitivity setting or wrong pre-amplification of the subsequent amplifier	Reduce the input sensitivity or pre-amplification of the subsequent device so that sufficient gain reserve remains.
	Wind influence	Use a suitable windshield (see page 10).
	Plosives	Use a suitable popshield (see page 10).
	Structure-borne noise transmission	Use a suitable shock mount (see page 7).
Sound muffled, spatial	Pick-up pattern has been ignored	Check if the microphone is spoken into from the correct side. Make sure that the Sennheiser logo or the slanted front of the sound inlet basket faces your body.

Manufacturer Declarations

Warranty

Sennheiser electronic GmbH & Co. KG gives a warranty of 24 months on this product.

For the current warranty conditions, please visit our website at www.sennheiser.com or contact your Sennheiser partner.

In compliance with the following requirements

- RoHS Directive (2002/95/EC)
- WEEE Directive (2002/96/EC)





Please dispose of this product at the end of its operational lifetime by taking it to your local collection point or recycling center for such equipment.

CE Declaration of Conformity

- EMC Directive (2004/108/EC)

The declaration is available at www.sennheiser.com.

In compliance with:

Europe	 EMC EN 55103-1/-2
USA	FCC 47 CFR 15 subpart B
Canada	Industry Canada ICES_003
China	
Australia/ New Zealand	 N340

This device complies with Part 15 of the FCC Rules and with RSS-210 of Industry Canada. Operation is subject to the following two conditions: (1) this device may not cause harmful interference, and (2) this device must accept any interference received, including interference that may cause undesired operation.

This class B digital apparatus complies with the Canadian ICES-003
Cet appareil numérique de la classe B est conforme à la norme
NMB-003 du Canada

Changes or modifications made to this equipment not expressly approved by Sennheiser electronic Corp. may void the FCC authorization to operate this equipment.

DE

EN

FR

IT

ES

NL

RU

ZH



Sennheiser electronic GmbH & Co. KG

Am Labor 1, 30900 Wedemark, Germany
www.sennheiser.com

Printed in Germany, Publ. 09/10, 540080/A01



SENNHEISER