

# Smart-AMI

SMART AUDIO VIDEO INNOVATION

## User Manual

## CATSWITCH



Switch up to 16 remote devices to 16 remote displays located up to 1500ft away.

**Notice:**

The information contained in this document is subject to change without notice. SmartAVI makes no warranty of any kind with regard to this material, including but not limited to, implied warranties of merchantability and fitness for any particular purpose.

SmartAVI will not be liable for errors contained herein or for incidental or consequential damages in connection with the furnishing, performance or use of this material.

No part of this document may be photocopied, reproduced or translated into another language without prior written consent from SmartAVI.

# Table of Contents

Chapter 1: Introduction .....	4
What's in the Box .....	4
Overview .....	5
Applications .....	5
Chapter 2: Installation.....	6
Connecting the XTAV Transmitter.....	6
Connecting the XTPro Transmitter .....	7
Connecting the XTWall Transmitter .....	8
Connecting the XTWall Receiver.....	9
Connecting the XTPro-RX .....	10
Connecting the XTAV-RX .....	11
Connecting the CATSWITCH .....	12
Connecting the RS232 Devices .....	13
CAT5 Preparation .....	14
Chapter 3: Software Installation and Operation .....	15
The Matrix Panel .....	16
The Button Panel .....	17
Macros .....	18
Controlling with IR .....	19
Controlling the SMTCP .....	20
Chapter 4: Technical Information .....	22
Chapter 5: Communications Protocol .....	25
Chapter 5: Appendices .....	26

# Chapter 1: Introduction

## Ordering Information:

Part Number	Description
CSW08X08S	CAT5 Matrix audio/video 8x8 matrix with RS232 control. Includes: [CSW08X08 (SM-CSW) and (CCPWR06US) or (CCPWR06EU)]
CSW16X08S	CAT5 Matrix audio/video 16x8 matrix with RS232 control. Includes: [CSW16X08 (SM-CSW) and (CCPWR06US) or (CCPWR06EU)]
CSW16X16S	CAT5 Matrix audio/video 16x16 matrix with RS232 control. Includes: [CSW16X16 (SM-CSW) and (CCPWR06US) or (CCPWR06EU)]
CSWP08X08S	CAT5 Matrix audio/video/IR and R232 8x8 matrix with RS232 control. Includes: [CSWP08X08 (SM-CSW) and (CCPWR06US) or (CCPWR06EU)]
CSWP16X08S	CAT5 Matrix audio/video/IR and R232 16x8 matrix with RS232 control. Includes: [CSWP16X08 (SM-CSW) and (CCPWR06US) or (CCPWR06EU)]
CSWP16X16S	CAT5 Matrix audio/video/IR and R232 16x16 matrix with RS232 control. Includes: [CSWP16X16 (SM-CSW) and (CCPWR06US) or (CCPWR06EU)]

Part Number	Receivers and Accessories
XTP-TXS	XTPRO UXGA/Audio/RS232/IR transmitter with Local Video . Includes:[ XTP-RX and (PS5VD1A)]
XTP-RXS	XTPRO UXGA/Audio/RS232/IR receiver with Dual Video Includes:[ XTP-RX and (PS5VD1A)]
XTP-RXLS	UXGA/Audio/RS232/IR Long Range receiver. Includes:[ XTP-RXL and (PS5VD1A)]
XTX-RXS	XT Xpress UXGA/Audio receiver. Includes:[ XTJ-RX and (PS5VD1A)]
XTJ-TXS	XT UXGA/Audio transmitter. Includes:[ XTJ-RX and (PS5VD1A)]
SM-TCPS	TCP/IP Control include SMTCP, (CCRS232MM ) and (PS5VD1A)]
SM-EYE	External infrared receiver. IR range of 10' to 30'
RMT-2	Remote control device

# Chapter 1: Introduction

## Overview

At times multiple AV signals need to be transferred to multiple nearby output monitors. CatSwitch allows multiple VGA/audio inputs to be routed to multiple outputs simultaneously, by way of a direct connection into the router.

CatSwitch is a high-quality switching matrix for VGA type signals. All signal formats are catered for including VGA, SVGA, XGA, RGBHV and sync on green (SOG) applications. For ease of installation, Standard VGA connectors (HD15 sockets) are used for the input as well as the output video signal. All that is required is a standard pin-to-pin VGA cable to connect to the signal source.

Stereo audio can also be routed to multiple outputs. The audio can either be routed independently or together with the video signal using the SmartControl software that is very easy to use.

Note: for maximum signal performance, use only high quality cable that has internal coaxial cable for each color.

The units contain a very high bandwidth routing matrix for the Red, Green and Blue video channels.

## Applications

- Wall Displays
- Audio Visual Presentation
- Digital media
- Shopping centers
- Airports
- Security
- Dealer rooms
- Point of sale
- Control rooms
- Hotels

# Chapter 2: Installation

## Connecting XTAV transmitter

### Connecting The Transmitter

1. Connect the output of the computer video card to the video input of the transmitter using the included male to male video cable.
2. Connect the output of the computer audio card to the audio input of the transmitter using 3.5mm audio male to male audio cable.
3. Connect external speakers to the transmitter's audio out (Standard 3.5mm stereo miniplug).
4. In the back of the unit connect the CAT5 cable that will connect to the receiver (XTAV-RX).

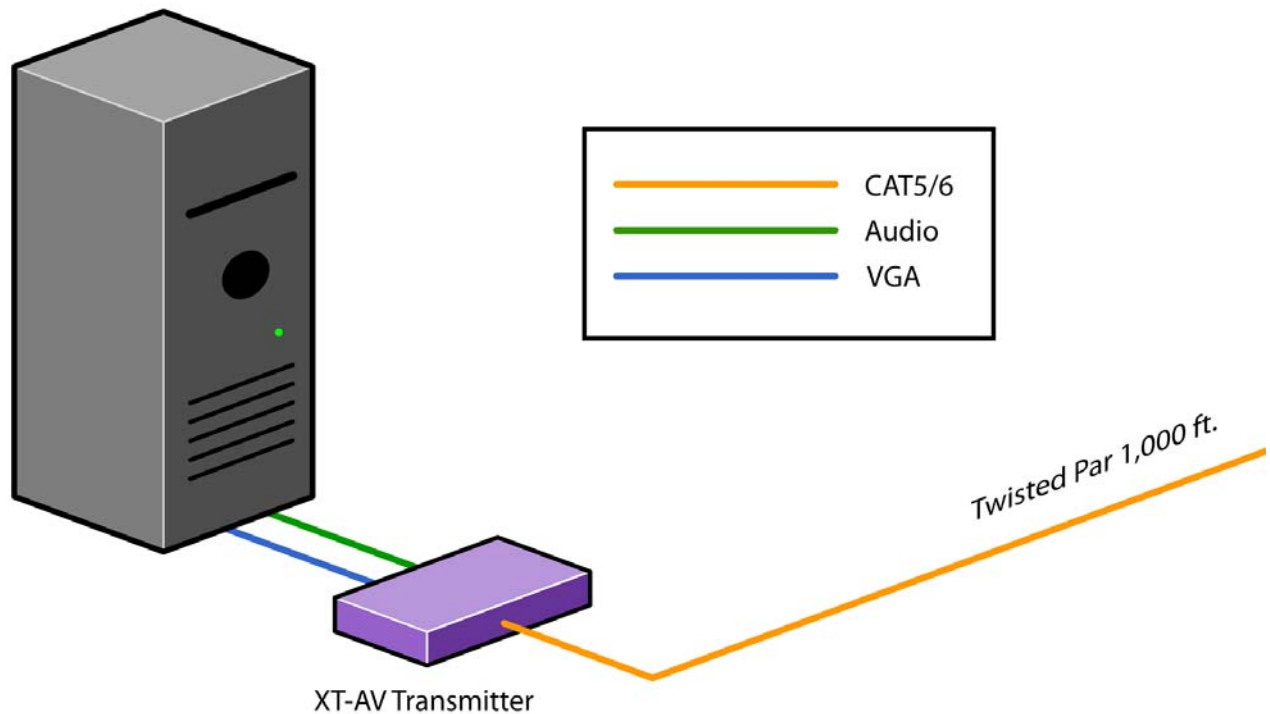

# Chapter 2: Installation

## Connecting the XTPro transmitter

### Connecting The Transmitter

1. Connect the output of the computer video card to the video input of the transmitter using the included male to male video cable.
  2. Connect the output of the computer audio card to the audio input of the transmitter using 3.5mm audio male to male audio cable.
  3. Connect local monitor to the VGA out of the transmitter.
  4. Connect external speakers to the transmitter's audio out (Standard 3.5mm stereo miniplug).
  5. In the back of the unit connect the CAT5 cable that will connect to the receiver (XTPRO-RX).
- \*NOTE: You can not use RS232 and IR at the same time.

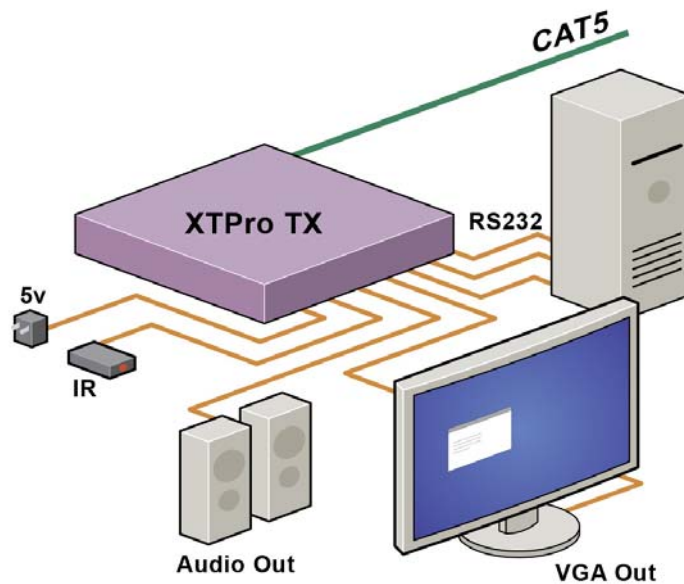

# Chapter 2: Installation

## Connecting XTWALL Transmitter

### Connecting The Transmitter

1. Connect the output of the computer video card to the video input of the transmitter using the included male to male video cable.
  2. Connect the output of the computer audio card to the audio input of the transmitter using 3.5mm audio male to male audio cable.
  3. Connect local monitor to the VGA out of the transmitter.
  4. Connect external speakers to the transmitter's audio out (Standard 3.5mm stereo mini-plug).
  5. In the back of the unit connect the CAT5 cable that will connect to the receiver (XTW-RX).
- \*NOTE: You can not use RS232 and IR at the same time.

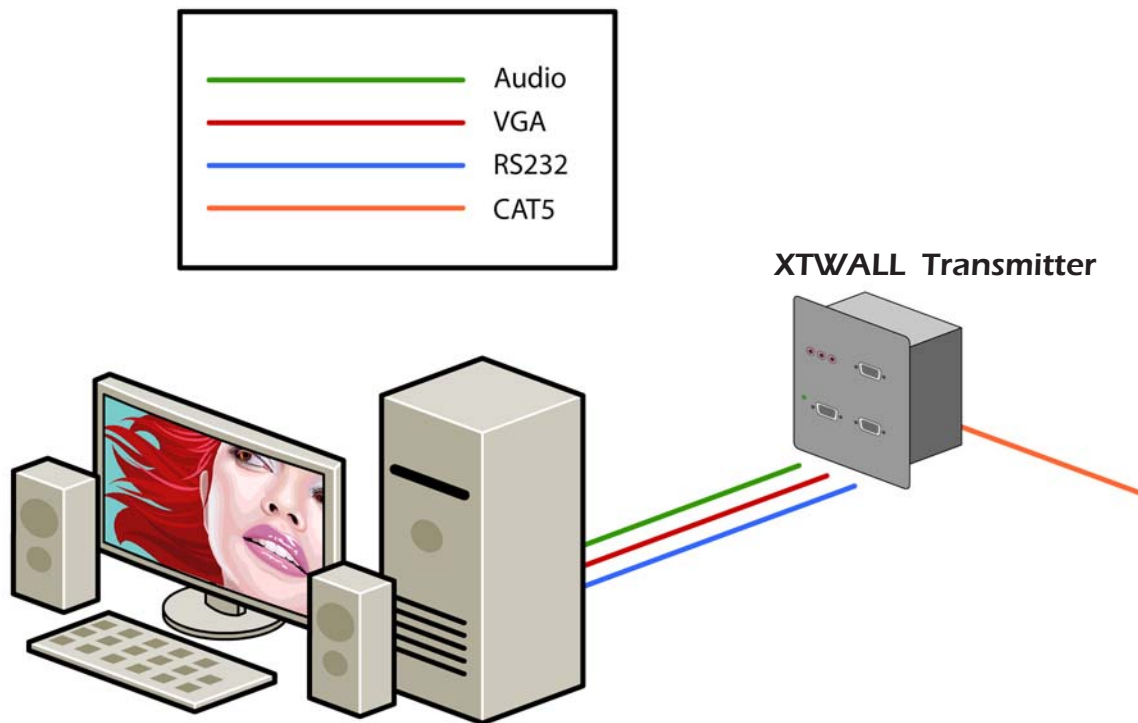



# Chapter 2: Installation

## Connecting XTWALL Receiver

### Connecting The Receiver

1. Connect CAT5 cable (coming from the transmitter) to the back of the receiver.
2. Connect 1-2 display monitors to the VGA out connectors on the front of the receiver.
3. Connect 1-2 sets of external speakers to the audio output connections on the front of the unit. (Standard 3.5mm stereo Miniplug)

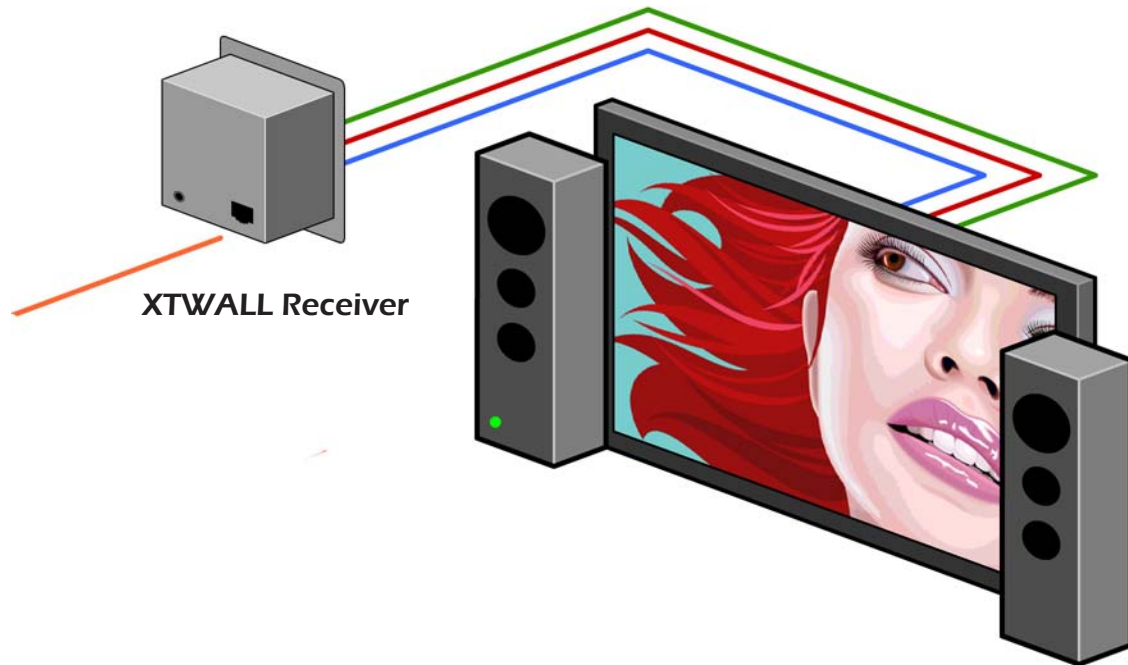

### Adjusting and Tuning the Signal

In order to fine tune the signal, adjust the individual dials one at a time starting with GREEN, then BLUE, and lastly RED. As you turn the dials you will notice the colors slightly change as you increase or decrease the strength. All dials should be around the same distance



# Chapter 2: Installation

## Connecting the XTPro-RX

### Connecting The Receiver

1. Connect CAT5 cable (coming from the transmitter) to the back of the receiver.
2. Connect 1-2 display monitors to the VGA out connectors on the front of the receiver.
3. Connect 1-2 sets of external speakers to the audio output connections on the front of the unit. (Standard 3.5mm stereo Miniplug)

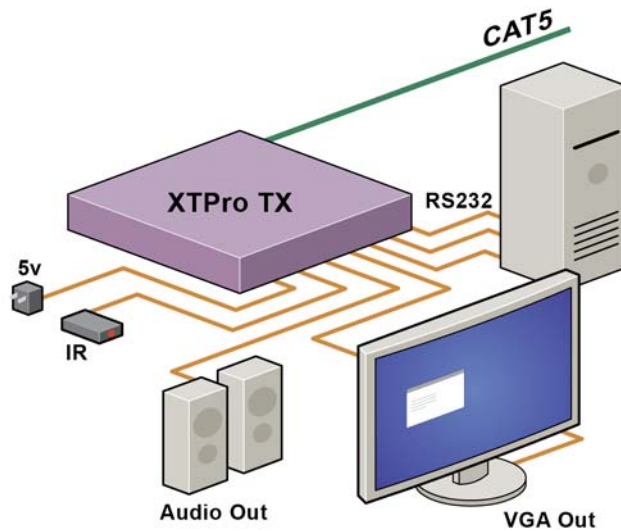

### Adjusting and Tuning the Signal

In order to fine tune the signal, adjust the individual dials one at a time starting with GREEN, then BLUE, and lastly RED. As you turn the dials you will notice the colors slightly change as you increase or decrease the strength. All dials should be around the same distance.

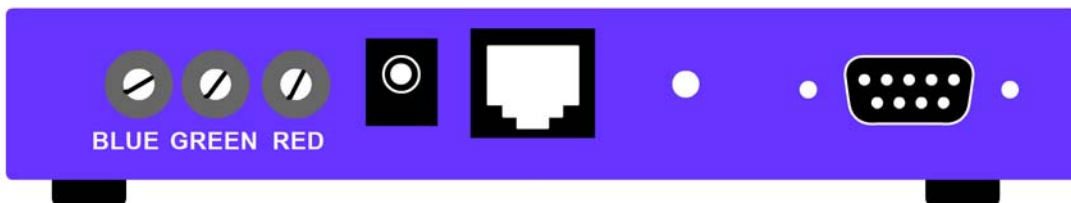

# Chapter 2: Installation

## Connecting the XTAV-RX

### Connecting The Receiver

1. Connect CAT5 cable (coming from the transmitter) to the back of the receiver.
2. Connect display monitors to the VGA out connector on the front of the receiver.
3. Connect external speakers to the audio output connections on the front of the unit. (Standard 3.5mm stereo Miniplug)

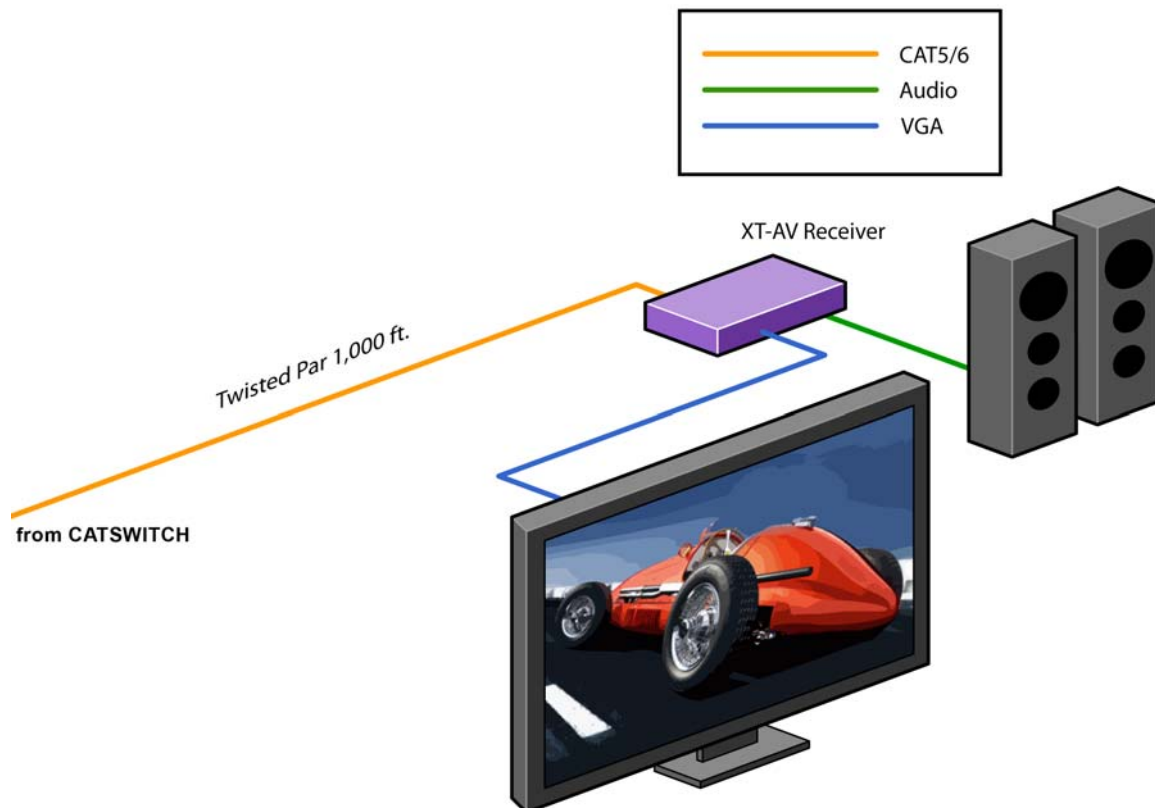

### Adjusting and Tuning the Signal

In order to fine tune the signal, adjust the individual dials one at a time starting with GREEN, then BLUE, and lastly RED. As you turn the dials you will notice the colors slightly change as you increase or decrease the strength. All dials should be around the same distance

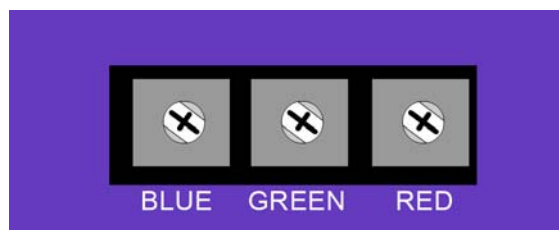

# Chapter 2: Installation

## Connecting the matrix

Now you are ready to connect the CATSWITCH,

Connect all the cat5 coming from the transmitters to the inputs of the catswitch

Connect all the cat5 going to the receivers to the output

## Connecting the the Main unit, the CATSWITCH

Make sure the unit is powered off before connecting all the cables

### Connecting all the Transmitters

1 Locate the RJ45 jacks on the back of the catswitch,

2 Connect the Cat5 cable to the RJ45 and mark each cable with the number of the transmitter

3 repeat steps for all transmitters cables

### Connecting all the receivers

1 Locate the RJ45 jacks on the back of the catswitch,

2 Connect the Cat5 cable to the RJ45 and mark each cable with the number of the receivers

3 REPEAT steps for all receivers cables

After all connection are made, you can turn on the catswitch,

on the front on the units 2 leds will show normal operation of the unit

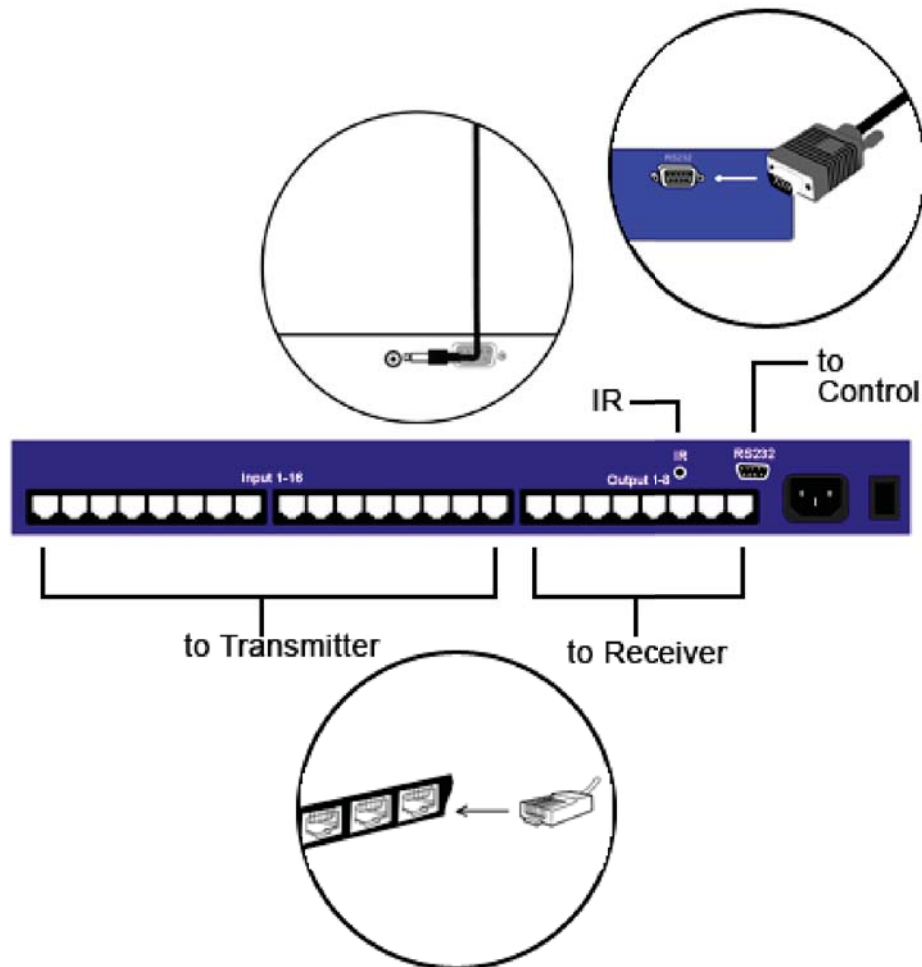

# Chapter 2: Installation

## Connecting the Control Communication Cable: RS-232

Each unit can be controlled by a RS-232 port connected from the back of the chassis. The SmartControlPro software will be used to control the units.

1. Connect the RS-232 cable the control computer by connecting the female RS-232 connector into the male RS-232 connector of the PC. Turn the side screws so that it does not accidentally become disconnected
2. Connect RS-232 cable connector to the male RS-232 connector on the back of the chassis.

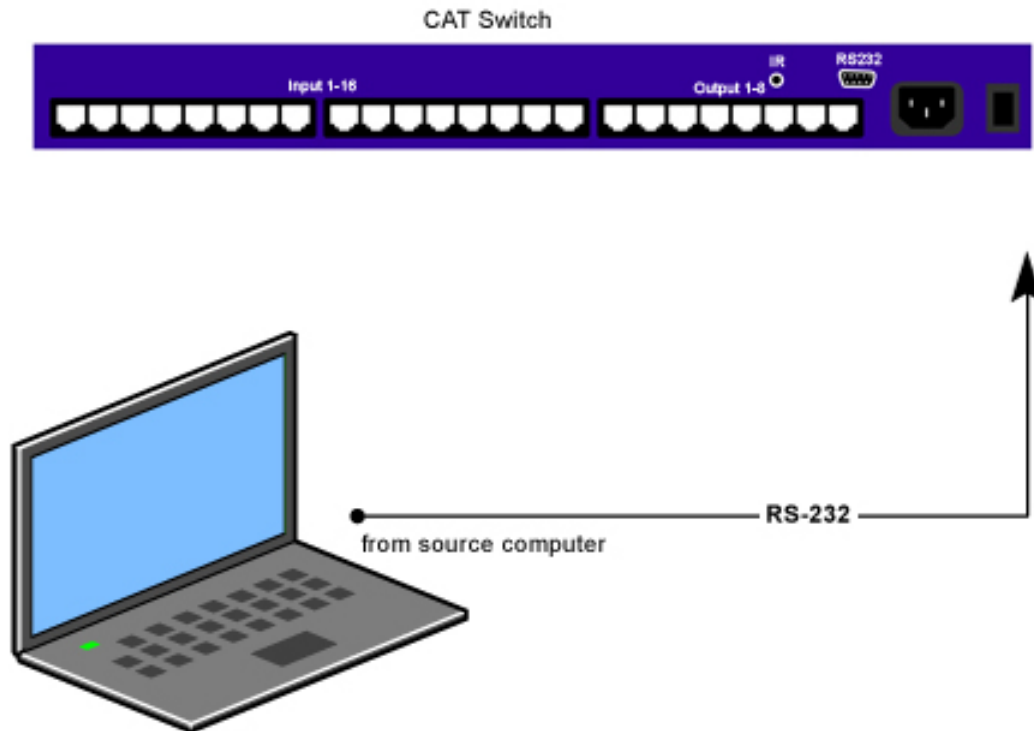

## Connecting the CATSWITCH

CATSWITCH connection diagram

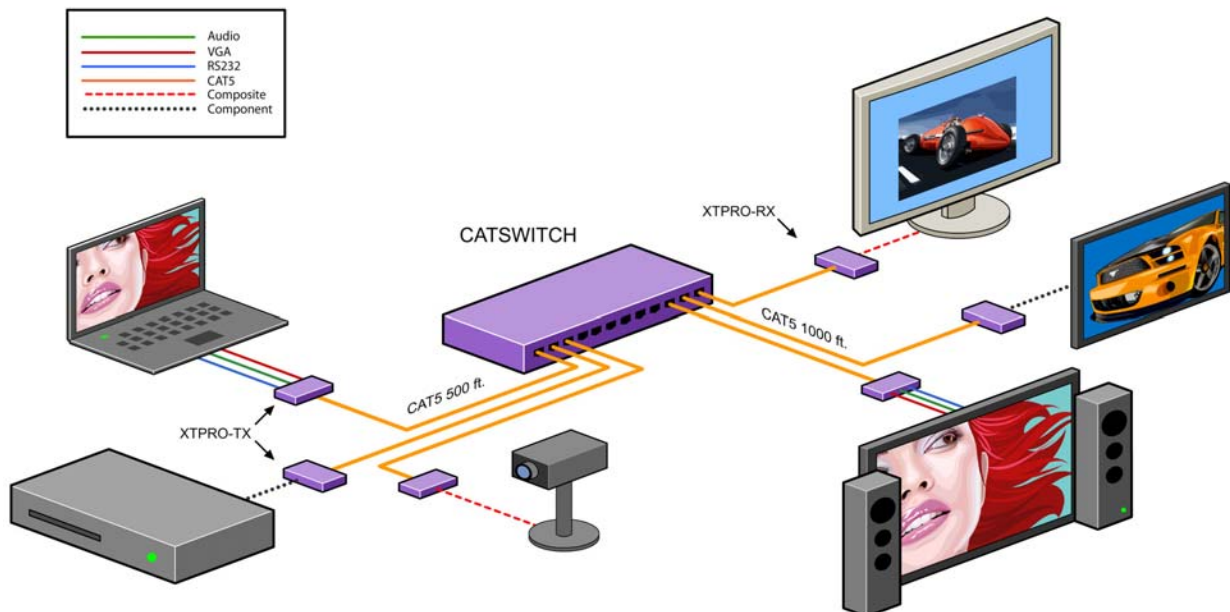

# Chapter 2: Installation

## CAT5 Preparation

The CATSWITCH is a point to point video extender/switcher. The system does not allow to connecting the Cat5 via hubs or any kind of switches that the point to point connection need be maintained. The 16 RJ45 ports on the front of the CATSWITCH are output ports, providing connectivity to the XTPro or XT-AV receiver. This is a standard RJ45 connector, the CATSWITCH can be connected via either Cat5, Cat5e or Cat6 cabling.

**PORT,  
RJ45 Female**

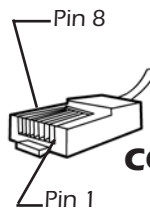

**CONNECTOR, RJ45 Male**

Table below describes the pinout configuration of the SmartAVI Cat5

SmartAVI Proprietary Connector			
Pair	Color	RJ45 Pin	Description
1	White/Orange	1	Video+Audio
	Orange	2	
2	White/Green	3	Video+Audio
	Green	6	
3	Blue	4	Video+Audio
	White/Blue	5	
4	White/Brown	7	DATA RS232 and IR Bidirectional
	Brown	8	

Cable Instructions:  
Use 568B

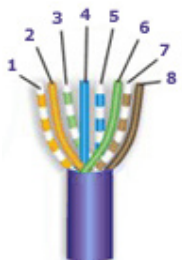
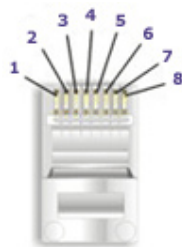

# Chapter 3: Software Installation & Operation

Find the Installation CD that came with your CATSWITCH unit. This CD has the SmartControlPro software that you will need in order to control the unit using a computer.

Insert the CD into your CD-ROM. On the CD you should see:

- SmartControl Pro Installer.exe
- SmartControl Pro Help File
- CATSWITCH Manual in PDF format

Double click SmartControlPro.exe in order to initiate software installation. Click Install. After installation has completed, click CLOSE.

In order to use the software, click on the START button>Programs>SmartControl Pro. There you should see a help file, the SmartControl Pro launcher as well as a shortcut to uninstall SmartControl Pro. Click on SmartControl Pro in order to launch the software.

When the software starts you will see a screen like this.

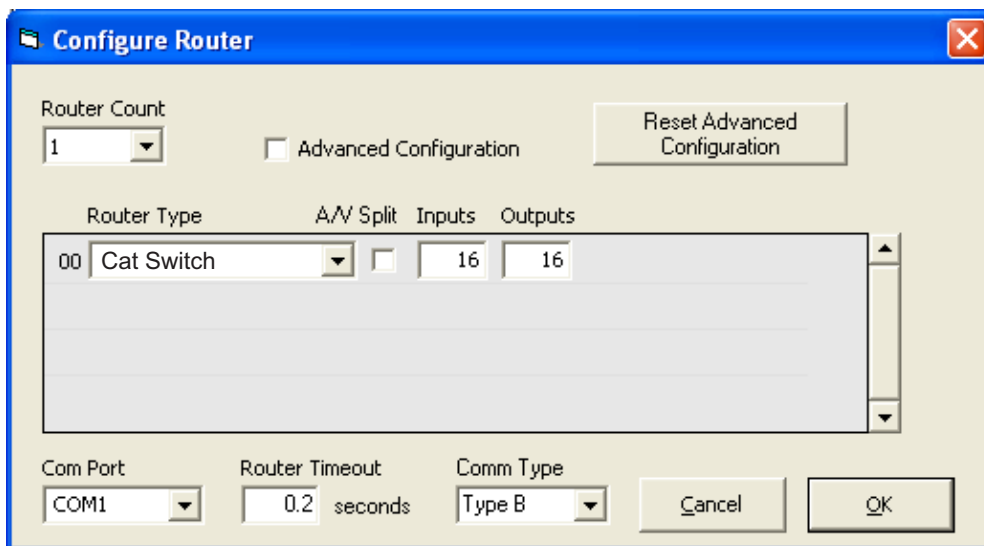

**Advanced Configuration:** If you have more than one Router installed you will want to check this box.

**Router Type:** Select "CATSWITCH"

**A/V Split:** Check this box if you need to route audio and video independently, regardless from which source they originated from. Leave unchecked if you want audio and video signals from the same input to remain together.

For example, if you wanted to route different video feeds to different locations but wanted all of them to have the same audio, you should check the box.



# Chapter 3: Software Installation & Operation

**Inputs/Outputs:** Enter the number of Inputs/Outputs your CATSWITCH has. For now we will assume that there are 16 inputs and 16 outputs.

**Com Port:** Select the appropriate com port that your computer is using to access the router.

**Router Time out:** By default this is 0 meaning the computer acknowledges commands almost instantly. Sometimes a computer takes longer to respond. This setting should be left at 0. If you need to change it, it should be no higher than 0.2.

After you have entered in the necessary information click OK. This will now take you to the Main Routing Window where you can route the different video/audio connections.

Main **CATSWITCH** window

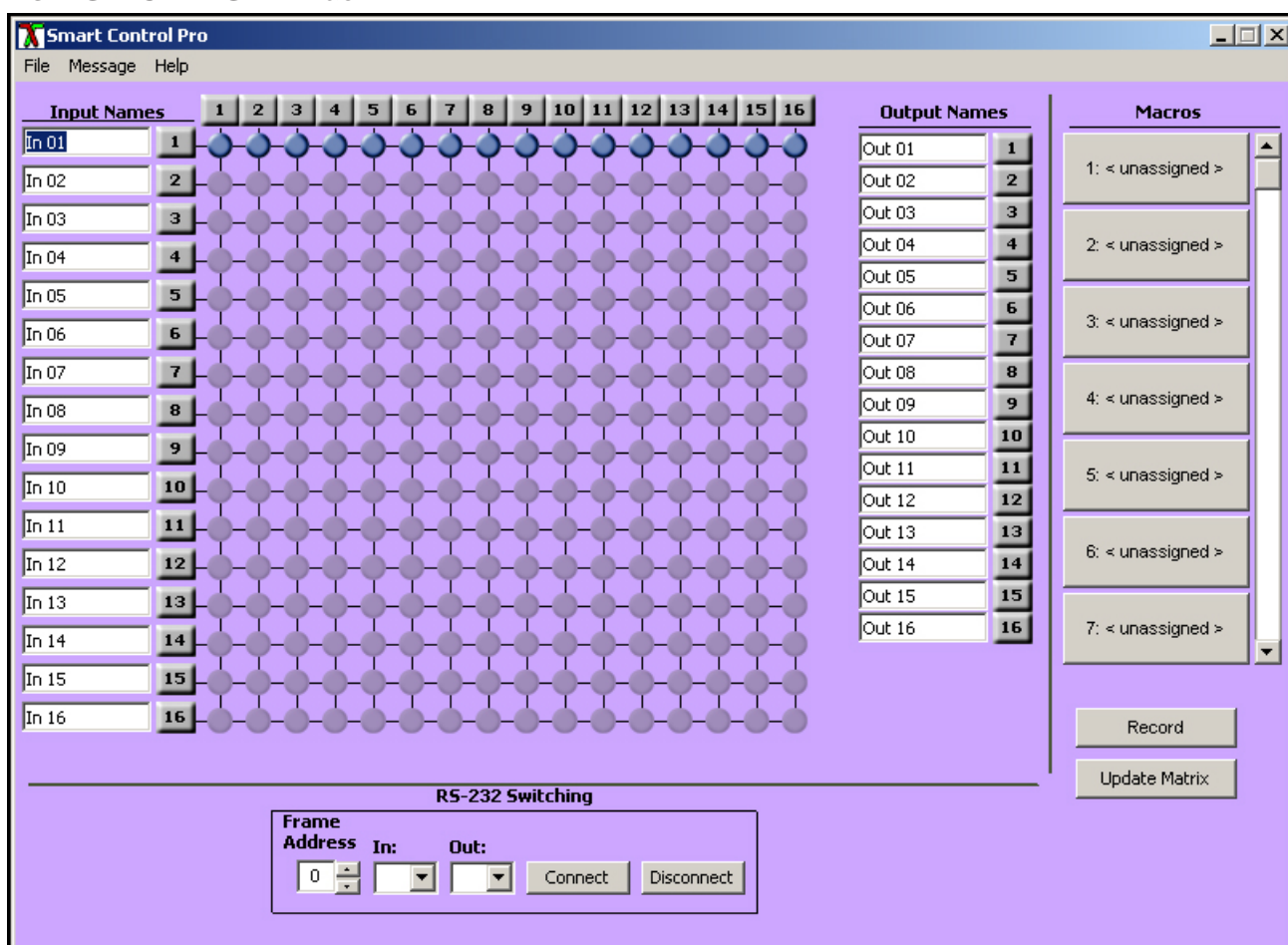

On this screen you will notice the input buttons running down the left side while the output buttons run across the top. They are each labeled 1 through 16.

Note: The three small colored buttons at the lower right labeled ALL, VIDEO, and AUDIO are not available if AV Split was not checked when you configured your router.



# Chapter 3: Software Installation & Operation

The Main Routing Window enables you to control the router(s) connections by means of the CATSWITCH panel, the button panel, or with pre-recorded routes called macros.

CATSWITCH Panel: This is probably the simplest way to route the connections. Simply click on the cross point itself. The input on the left will then be routed to the output above.

Note: Inputs can be routed to several different outputs, but each output can only have a single input at any one time. So you can have several connections horizontally but not vertically.

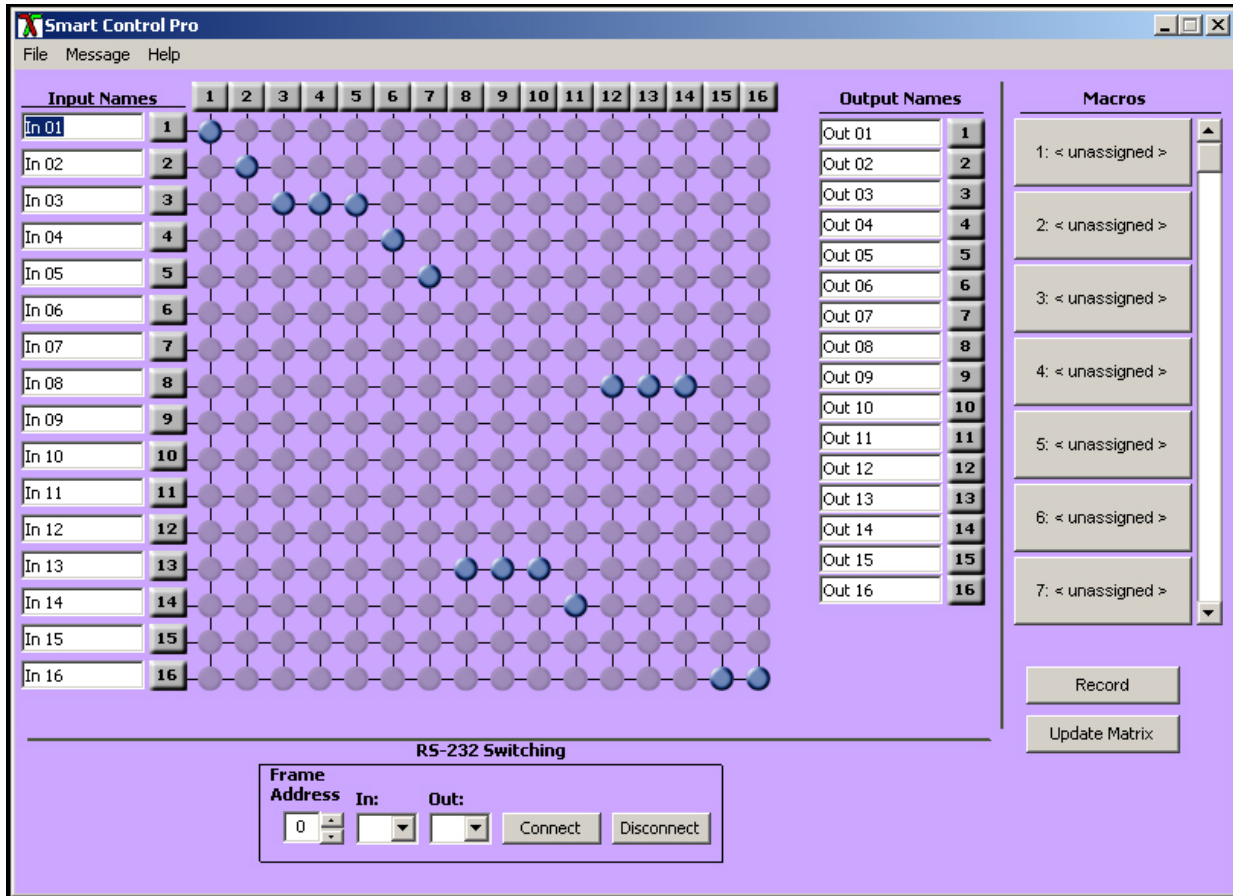

The Button Panel: These are the numbered buttons across the top and left sides. Click an output button on the top, and then click an input button on the left.

Options for using the Button Panel

- **Output Options:**

To select multiple outputs next to each other, click on one output, then hold the shift key down and click the last output. When the input is clicked, it is routed to all selected outputs.

To select multiple outputs individually, hold the control key down and click on any number of outputs. When the input is clicked, it is routed to all selected outputs.

- **Input Options:**

To route an input to all the outputs at once, hold the control key down and click on an input.

To leave the outputs selected after the route is made, hold the shift key down and click on an input.

# Chapter 3: Software Installation & Operation

**Macros: This section of the window is used to save and play back macros. Macros store a set sequence of routes.**

To record a macro:

1. Click on the Record button (last button shown above). A blinking "recording" message below this button will be displayed to indicate that all routes are being recorded.
2. Select the desired cross points. (See CATSWITCH Routing for details on making these routes.) There is no limit on the number of routes you may record.
3. If you click a macro button while in the record mode, the macro will be executed, and these routes will be added to the recording. This makes it possible to combine the routes of two or more macros into one bigger macro.
4. When finished, click the "Save Macro" button. You will be instructed to then click on one of the macro buttons. Doing this will save the recorded routes to that button.

To cancel saving the macro, click the "Cancel Save" button.

5. To play back a macro, simply click on one of the 50 macro buttons. Use the scroll bar to bring any of these into view.
6. The macros are automatically saved in the current configuration file. They are also saved when you select the File/Save Configuration... menu.

To save macros in a separate file for a special purpose, select the File/Save Macros...menu.

# Chapter 3: Software Installation & Operation

## Controlling with IR

### Switching Ports with Remote Control

You have the option of controlling the CATSWITCH via Remote Control. The PLAZOOM remote is used to control the CATSWITCH. The SM-EYE must be connected to the CATSWITCH ( this is an optional connector not always available in all boxes) in order to interface the remote control with the matrix. The way the remote control the matrix is as follows:

Xx<enter>yy<enter>

When XX is the output , YY is the input

To change the routing of the signals,

For example, to set output 3 to input 2 press "0" + "3" + ENTER, then press "0" + "2" + ENTER. If a wrong button is pressed, the user must either press the ESC button or wait 5 seconds before restarting the sequence.



# Chapter 3: Software Installation & Operation

## Connecting the SMTCP

### Instructions

3.0 RS232/422 converter.

1. The frame control interface uses RS422. A full duplex 5 wire balanced communications standard that allows communications to be multi-dropped to more than one Frame.
2. Since PC's only come with RS232 ports, a small converter is required to convert the RS232 signals to RS422.
3. If you purchased any of the SmartAVI software options you will have received a suitable converter and cable.



Figure 2

### Operation

1. Connect to SMTCP by typing `http://192.168.2.1` in the address field of your browser, then click Enter. (Figure 1)
2. A login window will open.
3. For security reasons, the SMTCP has its own user name and password. When prompted, enter Administrator for the SMTCP user name and admin for the SMTCP password. (figure2)
4. After accessing the browser, the user will be able to select these 4 functions;  
Input/Output Select to switch to different port in the router.  
TCP/IP Settings to choose another IP address  
Admin Password change your password\*  
Logout.

When changing input output, press update to send the command to the matrix.

\*It is strongly suggested that you change your login and password at this time.

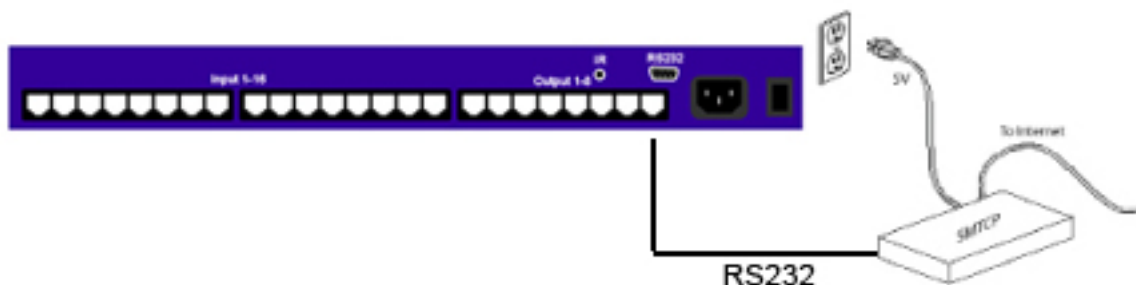

# Chapter 3: Software Installation & Operation

## Connecting the SMTCP con't

In certain cases, access to the smtcp box is not possible. Users have no way to change the IP via the network; a possibility to do this change is done via RS232, using a db9 cable male to male.

Using Smartavi software

Connect the SMTCP to the RS232, run smartavi Ip changer utility

1. Connect the SMTCP box to your PC's COM port with the Serial RS-232 cable.
2. Connect the SMTCP box to the network with an Ethernet cable.
3. Make sure box is plugged into the 5V adapter (power LED will be on)
4. Open IP\_Changer.exe

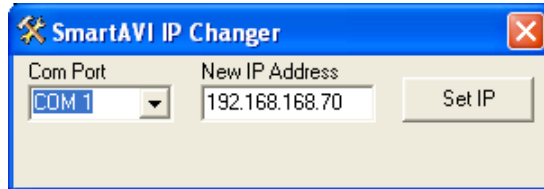

5. Use the Drop down list to select the COM port that the box is plugged into. (only the COM ports your PC has available will display)
6. Type the new IP address into the text box. (The default is 192.168.168.70 )
7. Click the "Set IP" button. If successful a message will appear for 5 seconds stating that the IP address has been changed.

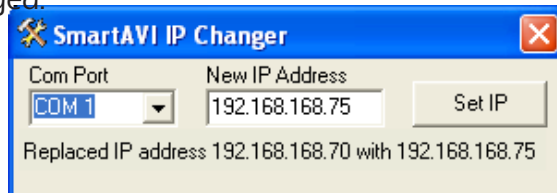

It's possible to achieve the following changes using any type of RS232 terminal software. All you will need to do is set your system to 9600,n,8 connect the RS232 cable, remove and replug the power. The box will send a full message to the screen. Run the following command to change the IP  
SET IP 192,168,0,1

# Chapter 4: Technical Information

<b>CATSWITCH SPECIFICATIONS</b>	
<b>Video</b>	
Bandwidth	250 MHz
Input Signal Level	1 Volt pk-pk into 75R
Output Impedance	100 Ohms
Input Impedance	75 Ohms
Connector	RJ45
Format	VGA/SVGA/XGA/RGBHV/RGsb
<b>Syncs</b>	
Bandwidth	Digital
Signal level	5V
Output Impedance	100 Ohms
Input Impedance	10K Ohms
Input Connector	HD15 socket
<b>Audio</b>	
Bandwidth	20KHz
Signal level	0dB
Output Impedance	100 Ohms
Input Impedance	100Ohms
Input Connector	VIARJ45
<b>Power</b>	
Voltage	90-230V
Connector	IEC
Fuse rating	1A A/S
Frequency	50/60 Hz
<b>Control</b>	
IR	Remote unit
RS232	Software
<b>Dimensions</b>	
Height X width X Depth	1U (133mm) x 19" x 450mm
Weight	10Kg

# Chapter 4: Technical Information

<b>XTPRO SPECIFICATIONS</b>	
<b>Receiver with dual monitors, Audio and IR/RS-232 support</b>	
<b>VGA Data</b>	
Format	RGBHV, RGsB, YUV, Y/C, CVBS
Resolution	Up to 1900 x 1200 VGA, SVGA, XGA, SXGA
Connector Type	HD 15 socket
<b>Audio</b>	
Signal Type	Stereo unbalanced
Connector Type	3.5mm jack socket
<b>Infrared</b>	
Signal Type	30 to 110Khz
Connector Type	3.5mm socket
<b>RS-232</b>	
Speed	2400 to 115Kbps
Connector Type	DB9 Male
<b>Power</b>	
Requirements	5VDC @.5A
Connector	2.1mm DC jack (center +ve)
<b>Physical</b>	
Dimensions	135 x 90 x 23mm (26 with pegs)
Weight	.8 lbs or .36 kg



<b>XTAV SPECIFICATIONS</b>	
<b>Receiver with Video and Audio support</b>	
<b>VGA Data</b>	
Format	RGBHV, RGsB, YUV, Y/C, CVBS
Resolution	Up to 1900 x 1200 VGA, SVGA, XGA, SXGA
Connector type	HD 15 socket
<b>Audio</b>	
Signal Type	Stereo unbalanced
Connector	3.5mm jack socket
<b>Power</b>	
Requirements	5VDC @.5A
Connector	2.1mm DC jack (center +ve)
<b>Physical</b>	
Dimensions	90 x 90 x 23mm (26 with pegs)
Weight	.6 lbs or .36 kg



# Chapter 4: Technical Information

<b>XTProWALL</b>	
<b>VGA Data</b>	
Format	RGBHV, RGsB, YUV, Y/C, CVBS
Resolution	Up to 1900 x 1200, VGA, SVGA, XGA, SXGA)
Connector Type	HD 15 socket
<b>Audio</b>	
Signal Type	Stereo unbalanced
Connector	3.5 mm jack socket
<b>RS232</b>	
	DB9M
	TXD, RXD, Gnd.
	9600 bps
<b>Power</b>	
Requirements	5VDC@.5A
Connector	2.1mm DC jack (center +ve)
<b>Physical</b>	
Dimensions	Face plate is 4.5" x 4.5
Weight	0.5 lbs





# Chapter 5: Communication Protocol

## SMARTCONTROL PRO RS-232 Protocol

Smartcontrol Pro is based on RS232 queries with CRC protocol, any software that can send hex or ascii code can control the CATSWITCH. Each box is called a frame and have a special number sending Audio/Video from any source to any remote.

1. To send any command the protocol will be as follow  
//FxxMyylzz<CHK><CR>  
All commands should start with //  
F is Frame Number  
M is destination (Monitor)  
XX is the number from 00 to 99  
I is the input ( computer,dvd...)  
Zz is the number of the input  
<CHR> is CRC calculation  
<CR> is carriage return (odh)

For example to send input 3 to monitor 12  
//F00M12I03<0x42><CR>

to send any input to all M will be 00

### **Sending RS232 from any source to any remote**

RS232 can be sent for one input to one output only. The protocol offers connect and disconnect

2. Connect any RS-232 cross point:  
//FxxRyylzz<CHK><CR>
3. To disconnect RS-232 cross point:  
//FxxDyylzz<CHK><CR>
4. To set new frame address:  
//FxxFnn<CHK><CR>
5. To query cross points from PC:  
//FxxU<CHK><CR>
  - If all outputs are connected to input 1 then a 4x4 Matrix will respond with  
<0x80><0x80><0x80><0x80><CR>
  - The router will send back one byte for each output and the string ends with a <CR>. The first byte sent is Output # 1. In the example above, since there are 5 bytes total, we know that there are 4 outputs.
  - To calculate the input number, the router sends the input number with the 7th bit set.
    - o 0x80 = "1000 0000" □ Input 0
    - o 0x81 = "1000 0001" □ Input 1
    - o ...
    - o 0x8F "1000 1111" □ Input 15

### **Notes:**

- When successful, commands #1-4 will acknowledge by sending the checksum with nibbles swapped & <CR><LF>
  - o e.g. checksum of 0x24 acknowledges with <0x42><CR><LF>
- All bytes in examples are Ascii characters unless they are contained in brackets <>
- <CHK> is Exclusive OR (XOR) of all previous bytes
- <CR> is carriage return, all commands sent from PC end with <CR>
- <LF> is line feed
- xx is the frame address of the router e.g. "00" or "01"
  - o From the factory the address is always "00", however it can be changed with command #4
- yy is the Output (monitor) number. e.g. "01"
- zz is the Input number. e.g. "06" or "16"
- nn is the Matrix's new frame address

# Chapter 6: Appendices

## Limited Warranty Statement

### A. Extent of limited warranty

1. SmartAVI Technologies, Inc. warrants to the end-user customers that the SmartAVI product specified above will be free from defects in materials and workmanship for the duration of 1 year, which duration begins on the date of purchase by the customer. Customer is responsible for maintaining proof of date of purchase.
2. SmartAVI limited warranty covers only those defects which arise as a result of normal use of the product, and do not apply to any:
  - a. Improper or inadequate maintenance or modifications
  - b. Operations outside product specifications
  - c. Mechanical abuse and exposure to severe conditions
3. If SmartAVI receives, during applicable warranty period, a notice of defect, SmartAVI will at its discretion replace or repair defective product. If SmartAVI is unable to replace or repair defective product covered by the SmartAVI warranty within reasonable period of time, SmartAVI shall refund the cost of the product.
4. SmartAVI shall have no obligation to repair, replace or refund unit until customer returns defective product to SmartAVI.
5. Any replacement product could be new or like new, provided that it has functionality at least equal to that of the product being replaced.
6. SmartAVI limited warranty is valid in any country where the covered product is distributed by SmartAVI.

### B. Limitations of warranty

TO THE EXTENT ALLOWED BY LOCAL LAW , NEITHER SMARTAVI NOR ITS THIRD PARTY SUPPLIERS MAKE ANY OTHER WARRANTY OR CONDITION OF ANY KIND WHETHER EXPRESSED OR IMPLIED , WITH RESPECT TO THE SMARTAVI PRODUCT , AND SPECIFICALLY DISCLAIM IMPLIED WARRANTIES OR CONDITIONS OF MERCHANTABILITY, SATISFACTORY QUALITY , AND FITNESS FOR A PARTICULAR PURPOSE

### C. Limitations of liability

To the extent allowed by local law the remedies provided in this warranty statement are the customers sole and exclusive remedies

TO THE EXTENT ALLOWED BY LOCAL LAW , EXCEPT FOR THE OBLIGATIONS SPECIFICALLY SET FORTH IN THIS WARRANTY STATEMENT , IN NO EVENT WILL SMARTAVI OR ITS THIRD PARTY SUPPLIERS BE LIABLE FOR DIRECT, INDIRECT, SPECIAL, INCIDENTAL, OR CONSEQUENTIAL DAMAGES WHETHER BASED ON CONTRACT , TORT OR ANY OTHER LEGAL THEORY AND WHETHER ADVISED OF THE POSSIBILITY OF SUCH DAMAGES.

### D. Local law

To the extent that this warranty statement is inconsistent with local law, this warranty statement shall be considered modified to be consistent with such law.

**SmartAVI, Inc.**  
**2840 N. Naomi Ave.**  
**Burbank, CA 91504**  
**Tel (818) 565-0011 Fax (818) 565-0020**  
**Email: [info@smartavi.com](mailto:info@smartavi.com)**

m\_catswitch-122308