



ULTRA Video Cabinets



StudioTech™

Jan 2011



## ULTRA Video Cabinet

The Ultra Series video component cabinets are attractive and accommodating with their unique metal screen (or fabric) doors and side panels. Large equipment bays are 19" deep to accommodate the largest of components. The center bay of the U-22T is 25" wide to fit center channel speakers and covered with acoustically transparent cloth. The side bays can be fitted with rails for rack mounted equipment. While the Ultra cabinets offer generous passive ventilation, fans are also available for additional cooling. Removable back panels make wiring access a snap. Optional rolling casters make moving the cabinets a breeze. Optional steel mounting pillars allow you to mount TV's and monitors above the unit like you would on a wall. Available in 3 real wood veneer finishes (Rosewood, Black Ash and Espresso) and two fabric colors (Black, White), this cabinet complements any home theater.

### U-22T BS Video Cabinet

*Shown in Espresso with Black screen*





**Check this out** If you send us your component dimensions, we will cut a custom face plate to cover your equipment exactly for a custom look that is only found on high end custom made furniture. This product is optional and additional fees apply. Call us today for details.

### WEIGHT CAPACITY

For detailed weight capacity, visit [www.studiotech.com](http://www.studiotech.com) for weight specifications

Each bay has 1 adjustable shelf and 18.5" of vertical internal space.

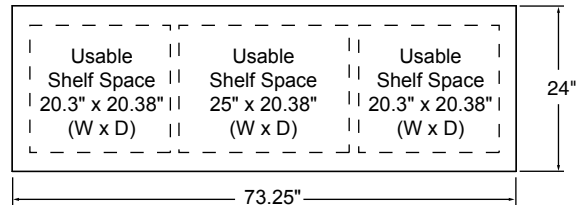

TOP VIEW



Front of unit shown here without doors and with the optional custom face plate. (Television and Components not included)

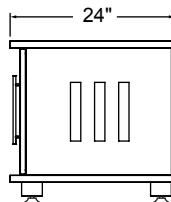

SIDE VIEW

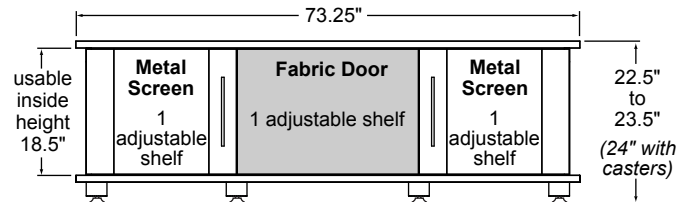

FRONT VIEW



### U-22T BB Video Cabinet

*Shown in Espresso and Black Fabric Doors  
(Television not included)*

**Check this out** *If you send us your component dimensions, we will cut a custom face plate that will cover your equipment exactly for a custom look that is only found on high end custom made furniture. This product is optional and additional fees apply. Call us today for details.*



Side view with fabric panel.



Front of unit shown here without the doors and with optional custom face plate.  
*(Television and components not included)*



*U-22T in Espresso with Black Fabric Doors (Television not included)*



*U-22T in Espresso with White Fabric Doors (Television not included)*

## U-22T Video Cabinet

### Wood Finishes:

Espresso, Rosewood or Black Ash

### Fabric Options:

White or Black fabric doors and sides.

Each bay has 1 adjustable shelf and 18.5" of vertical internal space.



Fabric covered doors provide ventilation for components. Shown here with optional custom face plate.



Shown here with optional custom face plate for a clean elegant look. *(Components not included)*



Removable back panels and generous openings in the back panels allow easy access to components and wiring.



**U-22T EB** in Espresso with Black Fabric Doors  
(Television not included)



**U-22T** shown here with doors open.

#### WOOD FINISHES

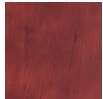

rosewood



black



espresso

#### FABRIC OPTIONS



white

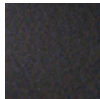

black

#### METAL SCREEN



black

#### WEIGHT CAPACITY

For detailed weight capacity, visit [www.studiotech.com](http://www.studiotech.com) for weight specifications

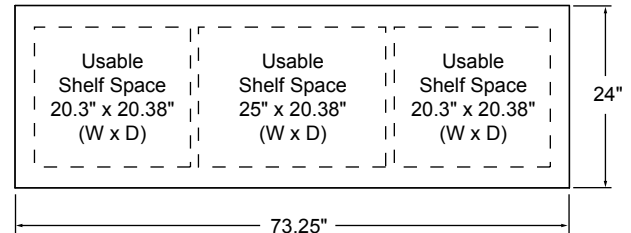

**TOP VIEW**

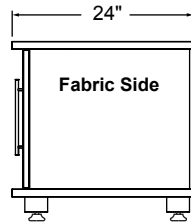

**SIDE VIEW**

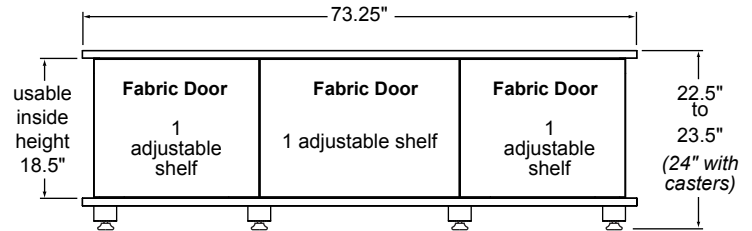

**FRONT VIEW**

## WALL MOUNT ACCESSORIES (OPTIONAL)

All Ultra video cabinet accommodates our optional plasma mounting pillars. These pillars are designed to accommodate most after market plasma mounts. Plasma mounts are not included with the pillars.

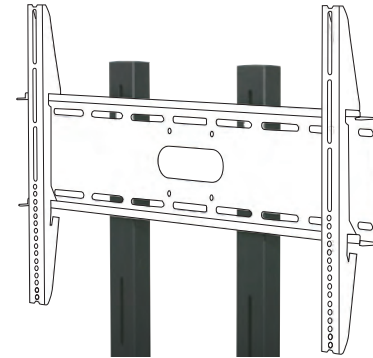

Steel pillars shown with universal mounting bracket  
(Mounting bracket sold separately).

## RACK RAIL ACCESSORIES (OPTIONAL)

For a full list of Rack Rail Accessories, see our website at [www.studiotech.com](http://www.studiotech.com)

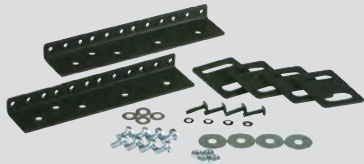

Rail Rail Hardware Kit



Rail Kits



Fan Kits



Media Drawers



Media Storage

## MOBILITY OPTIONS



Vinyl Glide Feet  
(Included)



Rolling Casters  
(Optional)

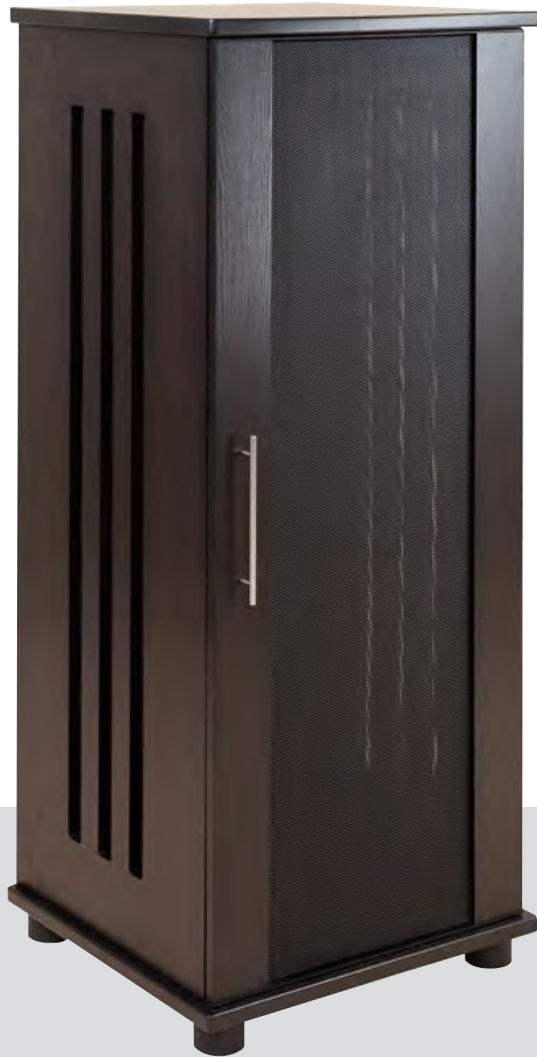

# ULTRA Audio Cabinet

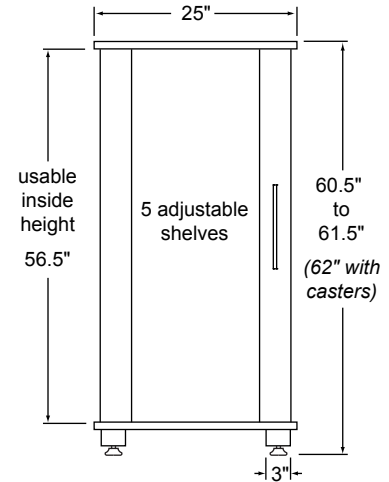
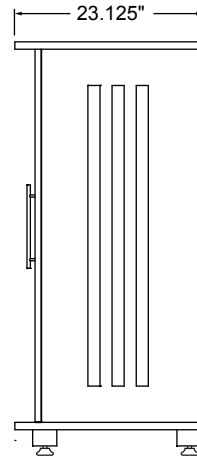
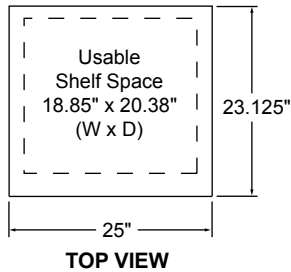

## WEIGHT CAPACITY

For detailed weight capacity, visit [www.studiotech.com](http://www.studiotech.com) for weight specifications

**U-60:** 5 adjustable shelves and 56.5" of vertical internal space.

## WOOD FINISHES

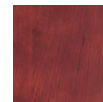

rosewood



black



espresso

## METAL SCREEN

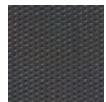

black

The Ultra U-60 complements the Ultra U-22T video cabinets with storage solely for audio components. This audio component cabinet is attractive, accommodating and full of ventilation. The large equipment bays are 19" deep to accommodate the largest of components. Optional back panel extenders allow for 21" depth. Each bay can be fitted with rails for rack mounted equipment. Elegance meets function with large ventilation slots in the sides of the unit as well as the full metal screen doors for maximum passive ventilation. Removable back panels make wiring access a snap. Optional rolling casters make moving the U-60 a breeze. Available in 3 real wood veneer finishes (Rosewood, Black and Espresso). This cabinet complements any home theater.

## U-60 ES Audio Cabinet

*Shown here in Espresso and Black screen*



## DETAILS



All cabinets come with plastic glides. Rolling casters are optional.



European style hinges.



High quality wood veneers and solid steel hardware compliment each other beautifully on the Ultra cabinets.

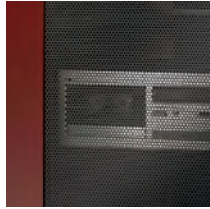

Metal screen provides ventilation and allows use of infrared remote controls.

## WOOD FINISHES

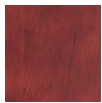

rosewood



black



espresso

## METAL SCREEN



black



### U-48 Rack Mount Cabinet

All Ultra cabinets can be fitted with standard EIA Rack mount rails which allow any 19" rack mount accessory to mount in either Ultra cabinet.



Optional rolling casters allow the Ultra cabinets to be moved easily for wire access or positioning.



Optional cooling fans are available.

## RACK RAIL ACCESSORIES (OPTIONAL)

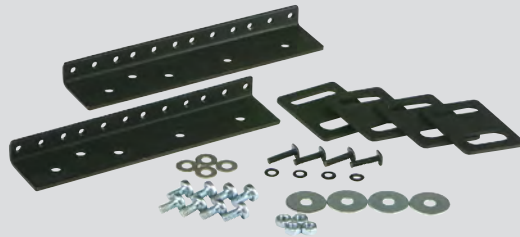

**Rail Rail Hardware Kit**



**Rail Kits**



**Fan Kits**



**Media Drawers**



**Media Storage**

*For a full list of Rack Rail Accessories, see our website at [www.studiotech.com](http://www.studiotech.com)*

## MOBILITY OPTIONS



**Vinyl Glide Feet  
(Included)**



**Rolling Casters  
(Optional)**

SKU	Description	Wood Color	Metal/Fabric Color
359	U-22T BS	Black	Black Screen
510	U-22T BB	Black	Black Fabric
511	U-22T BW	Black	White Fabric
361	U-22T RS	Rosewood	Black Screen
514	U-22T RB	Rosewood	Black Fabric
515	U-22T RW	Rosewood	White Fabric
480	U-22T ES	Espresso	Black Screen
537	U-22T EB	Espresso	Black Fabric
538	U-22T EW	Espresso	White Fabric
366	U-60 BS	Black	Black Screen
369	U-60 RS	Rosewood	Black Screen
500	U-60 ES	Espresso	Black Screen

**StudioTech**<sup>™</sup>

ULTRA Audio/Video Cabinets

JANUARY 2011

StudioTech, Inc., P.O. Box 5995, Irvine CA 92616  
 phone 714-241-9510  
 visit us online at: [www.studiotech.com](http://www.studiotech.com) [sales@studiotech.com](mailto:sales@studiotech.com)

StudioTech, Ultra, Ultra Furniture are trademarks of StudioTech, Inc.  
 © Copyright 2011 StudioTech, Inc.