

M350

DUAL ENGINE PROCESSOR



USER'S MANUAL

IMPORTANT SAFETY INSTRUCTIONS



The lightning flash with an arrowhead symbol within an equilateral triangle is intended to alert the user to the presence of uninsulated "dangerous voltage" within the product's enclosure that may be of sufficient magnitude to constitute a risk of electric shock to persons.



The exclamation point within an equilateral triangle is intended to alert the user to the presence of important operating and maintenance (servicing) instructions in the literature accompanying the product.

- 1 Read these instructions.
- 2 Keep these instructions.
- 3 Heed all warnings.
- 4 Follow all instructions.
- 5 Do not use this apparatus near water.
- 6 Clean only with dry cloth.
- 7 Do not block any ventilation openings. Install in accordance with the manufacturer's instructions.
- 8 Do not install near any heat sources such as radiators, heat registers, stoves, or other apparatus (including amplifiers) that produce heat.
- 9 Do not defeat the safety purpose of the polarized or grounding-type plug. A polarized plug has two blades with one wider than the other. A grounding type plug has two blades and a third grounding prong. The wide blade or the third prong are provided for your safety. If the provided plug does not fit into your outlet, consult an electrician for replacement of the obsolete outlet.
- 10 Protect the power cord from being walked on or pinched particularly at plugs, convenience receptacles, and the point where they exit from the apparatus.
- 11 Only use attachments/accessories specified by the manufacturer.
- 12  Use only with the cart, stand, tripod, bracket, or table specified by the manufacturer, or sold with the apparatus. When a cart is used, use caution when moving the cart/apparatus combination to avoid injury from tip-over.
- 13 Unplug this apparatus during lightning storms or when unused for long periods of time.
- 14 Refer all servicing to qualified service personnel. Servicing is required when the apparatus has been damaged in any way, such as power-supply cord or plug is damaged, liquid has been spilled or objects have fallen into the apparatus, the apparatus has been exposed to rain or moisture, does not operate normally, or has been dropped.

Warning!

- Do not expose this equipment to dripping and ensure that no objects filled with liquids, such as vases, are placed on the equipment.
- This apparatus must be earthed.
- Use a three wire grounding type line cord like the one supplied with the product.
- Be advised that different operating voltages require the use of different types of line cord and attachment plugs.
- Check the voltage in your area and use the correct type. See table below:

Voltage	Line plug according to standard
110-125V	UL817 and CSA C22.2 no 42.
220-230V	CEE 7 page VII, SR section 107-2-D1/IEC 83 page C4.
240V	BS 1363 of 1984. Specification for 13A fused plugs and switched and unswitched socket outlets.

- This equipment should be installed near the socket outlet and disconnection of the device should be easily accessible.
- Do not install in a confined space.
- Do not open the unit – risk of electric shock inside.

Caution:

You are cautioned that any change or modifications not expressly approved in this manual could void your authority to operate this equipment.

Service

- There are no user-serviceable parts inside.
- All service must be performed by qualified personnel.

IMPORTANT SAFETY INSTRUCTIONS

EMC / EMI

This equipment has been tested and found to comply with the limits for a Class B digital device, pursuant to part 15 of the FCC rules. These limits are designed to provide reasonable protection against harmful interference in residential installations. This equipment generates, uses and can radiate radio frequency energy and, if not installed and used in accordance with the instructions, may cause harmful interference to radio communications. However, there is no guarantee that interference will not occur in a particular installation. If this equipment does cause harmful interference to radio or television reception, which can be determined by turning the equipment off and on, the user is encouraged to try to correct the interference by one or more of the following measures:

- Reorient or relocate the receiving antenna.
- Increase the separation between the equipment and receiver.
- Connect the equipment into an outlet on a circuit different from that to which the receiver is connected.
- Consult the dealer or an experienced radio/TV technician for help.

For the customers in Canada:

This Class B digital apparatus complies with Canadian ICES-003.
Cet appareil numérique de la classe B est conforme à la norme NMB-003 du Canada.

Certificate of Conformity

TC Electronic A/S, Sindalsvej 34, 8240 Risskov, Denmark, hereby declares on own responsibility that following products:

M350 – Dual Engine Processor

- that is covered by this certificate and marked with CE-label conforms with following standards:

EN 60065 (IEC 60065)	Safety requirements for mains operated electronic and related apparatus for household and similar general use
EN 55103-1	Product family standard for audio, video, audio-visual and entertainment lighting control apparatus for professional use. Part 1: Emission.
EN 55103-2	Product family standard for audio, video, audio-visual and entertainment lighting control apparatus for professional use. Part 2: Immunity.

With reference to regulations in following directives:
73/23/EEC, 89/336/EEC

Issued in Risskov, April 2006
Mads Peter Lübeck
Chief Executive Officer

TABLE OF CONTENTS

INTRODUCTION

<i>Table of Contents</i>	3
<i>Introduction</i>	5
<i>Front Panel Overview</i>	6
<i>Rear Panel Overview</i>	8
<i>Signal Flow Diagram</i>	9
<i>Typical M350 Setups</i>	10

APPENDIX

<i>MIDI Implementation Chart</i>	30
<i>MIDI Continuous Controllers</i>	31
<i>Reset Procedure</i>	31
<i>MIDI Bulk Dump</i>	31
<i>Technical Specifications</i>	32

BASIC OPERATION

How to Operate the M350

<i>Input/Output Section</i>	16
<i>The Delay/Effects Engine</i>	18
<i>The Reverb Engine</i>	20
<i>Store</i>	21
<i>Recall</i>	21
<i>The Display</i>	21

Miscellaneous

<i>Factory Presets</i>	22
<i>MIDI channel</i>	22
<i>Sysex ID</i>	22
<i>M350 Software</i>	22
<i>Routings</i>	23

EFFECTS

Delay-effects

<i>Dynamic Delay</i>	24
<i>Studio Delay</i>	25
<i>Triplets Delay</i>	25
<i>Soft Delay</i>	25
<i>PingPong Delay</i>	25
<i>SlapBack Delay</i>	25

<i>Compressor</i>	25
<i>De-Esser</i>	26
<i>Chorus/Flanger</i>	26
<i>Phaser</i>	27
<i>Tremolo</i>	27

Reverbs

<i>Reverb types</i>	28
---------------------------	----

QUICK START – IF YOU JUST CAN'T WAIT

If you just can't wait to hear the great effects waiting for you in your new M350 Dual Effects processor, follow the few steps in this quick setup guide:

- Unpack the M350 and check for possible damages that could have been caused by transport.
- Read the safety instructions.
- Take a few minutes to register online via: www.tcelectronic.com or send in the registration card. Customers registered online will be notified directly via E-Mail about new tips & tricks and manual updates.

Consider the M350 as two effects processors in one box. We call these two processors "engines". The *Delay/Effects engine* creates one of the following effects: Delay, Chorus, Flanger, Phaser, Tremolo, De-Ess or Compression. The *Reverb engine* creates Reverb. These two Engines can be used separately or in conjunction.

Connections & Routing:

The M350 has two routing options that require two different ways of connecting. The Routing mode is set on the M350 rear panel and should correspond to your current setup.

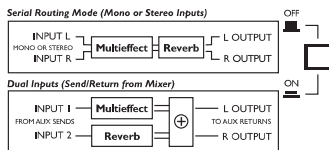

Serial Routing (switch in OUT position)
– utilizing both effect Engines in serial.

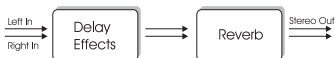

Dual Input mode (switch in IN position)
– ideal if you need to send signals from two different aux sends on your mixer and return on a stereo aux or two other channels.

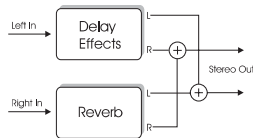

For detailed explanations on Routings and connections please read page 23.

- When all audio connections are made, connect power.
- Set the M350 to Preset Off mode using the PRESET ON/OFF key:

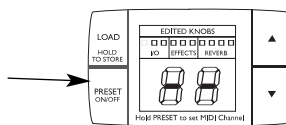

The M350 is in Preset Off mode when the display reads as illustrated above.

- **Set all controls in 12 o'clock position to hear factory settings.**
(For Dual Input mode set MIX to 100%.)
- Select an effect from the Delay/Effects section.
- Select a reverb type from the Reverb section.
- Start playing music through the M350.
- Adjust input level to a level just below the point where the two INPUT PPMs turn red.
- Set the desired mix between the dry and wet signal of the entire M350 using the MIX control.
- Set the desired balance between the Delay/Effects engine and the Reverb engine using the EFFECT BALANCE knob.
- Now tweak the controls for the two sections until you have the intended effects.
- (When using the Dual Input mode always set MIX to 100%)

For any questions left unanswered by this manual feel free to visit our online support center; **TC Support Interactive**, which can be accessed via: www.tcelectronic.com



Latest manual revision can always be downloaded from www.tcelectronic.com

INTRODUCTION

Congratulations on the purchase of your **M350 Dual Effects Processor** from **TC Electronic**

M350 is an extremely user-friendly dual engine rack processor which is equally suited for live and studio applications. It combines 15 quality reverbs with 15 multi-purpose effects including Delay, Modulation, De-Ess and compression. M350 features a front panel user interface, which is optimized for easy and speedy operation in a live performance situation. High density 24 bit processing and AD/DA conversion deliver the full transparency of TC reverbs and effects. M350 comes with an easy-to-read preset display, and provides MIDI in/out, MIDI clock tempo sync, pedal control of tap tempo, and global bypass. It provides 5 direct access parameters for quick and easy handling of parameter changes. The adaptive built-in power supply secures seamless operation at any main voltage with no need for clumsy wall-warts.

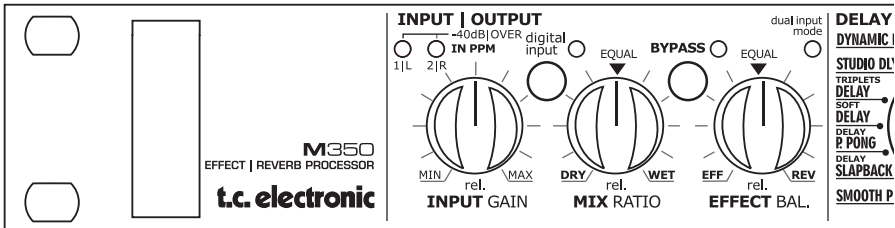
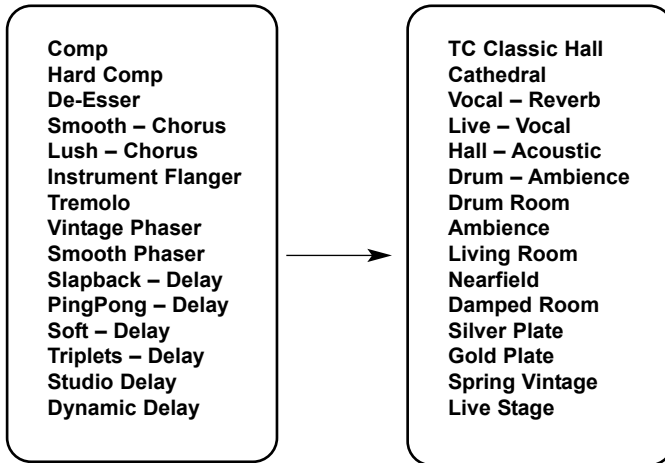

FRONT PANEL OVERVIEW

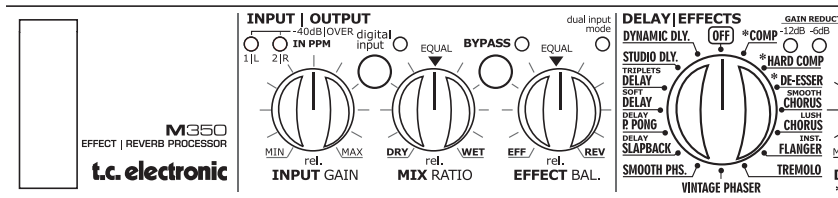

INPUT knob

Adjusts the input level.

1/L and 2/R LEDs

3 color LEDs indicating input level on left and right inputs.

Green: -40dB
Yellow: -6dB
Red: -1dB

MIX knob

Adjusts the mix between the wet and the dry signal. 100% "wet" is achieved at fully clockwise position.

EFFECTS BALANCE knob

Adjusts the balance between the Effects engine and the Reverb engine. Maximum effect from both engines is achieved at 12 o'clock position.

DIGI IN button and LED

LED Off

Digital input is set to off. The M350 processes only the signal present on the analog inputs.

LED Green

The M350 is locked correctly to the digital input signal.

LED Flashing

Digital in is selected but no digital signal is received, or the signal is corrupt. The M350 automatically returns to internal clock and analog operation.

BYPASS knob and LED

The bypass function varies depending on the selected routing (set on the rear panel):

Dual Input routing mode:

Bypass operates as "mute".

Serial routing mode:

Bypass routes the input signal to output.

MULTI-EFFECT selector

Selects between the 15 effects & Off in the Delay/Effects engine.

DELAY/TIMING knob

DE & TAP key

Tap the global tempo using the TAP key by tapping quarter notes. Now use the timing knob to multiply the tapped tempo.

The range varies from 0.5 to 2.

Example:

- Tap quarter notes at tempo 120 BPM. This equals 500 milliseconds.
- The range of the TIMING knob is 0.5 to 2 giving you a delay time varying from: 250ms to 1000ms. Note that the Slapback delay type has a shorter range as the Slapback delay by nature is a short delay.

DELAY/TIMING knob as AMOUNT/DRIVE control

For the Compressor and De-Ess algorithms (marked with an "*"*) this knob has different functions:

De-Ess : Amount
Compressor : Drive

FEEDBACK/DEPTH knob

Controls the Feedback or Depth parameter depending of the selected effect.

Delay : Feedback
Phaser : Depth
Tremolo : Depth
Flange : Depth
Chorus : Depth

FEEDBACK/DEPTH knob as FREQ/RATIO control

For the Compressor and De-Ess algorithms (marked with an "*""), this knob has different functions:

De-Ess : Frequency
Compressor : Ratio

-3, -6, -12 LEDs

These LEDs indicate the applied gain-reduction when Compressor or De-Ess algorithms are selected. Notice that the compressor uses automatic make-up gain to naturally compensate for the reduced gain.

FRONT PANEL OVERVIEW

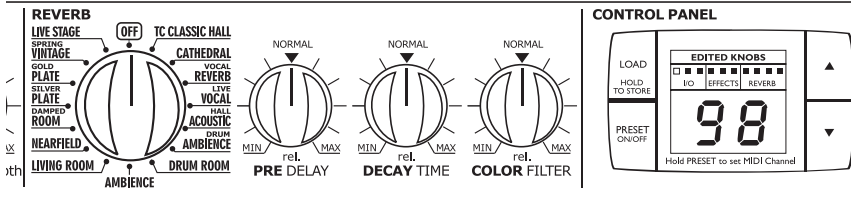

REVERB Type selector

Selects between 15 different reverb types or sets the Reverb engine to "Off".

PRE DELAY knob

Controls the relative pre delay of the selected Reverb.

DECAY knob

Controls the relative decay of the selected reverb.

COLOR knob

Controls the relative color of the selected reverb.

LOAD/HOLD TO STORE key

This key has two functions:

- Press once to load the preset selected via the CURSOR UP/DOWN keys.
- Press and hold to store the current preset.

PRESET ON/OFF key

The M350 has two preset modes:

Preset "Off" mode:

The display reads "- -".

In this mode the M350 will play effects according to the front panel controls.

When going from preset "On" to preset "Off" mode the effects will always be updated according to the positions of the front controls.

Preset "On" mode:

The display reads a specific preset number.

In this mode you can recall various user presets by using the UP/DOWN arrows followed by LOAD.

(Note that the M350 holds no stored factory presets apart from the default settings in the various effects).

Toggling between the preset On/ preset Off modes generates two situations:

From "On" to "Off":

The preset is updated according to the positions of the front controls.

From "Off" to "On":

The previously recalled preset number starts blinking in the display while the M350 still processes the signal according to the front controls. To actually load the preset, press LOAD.

Set MIDI channel

Press and hold the PRESET ON/OFF key approx. 2.5 sec. Now set the desired MIDI channel 1 to 16 or "o" for OMNI (receives on all channels) or OF for Off, using the ARROW UP/DOWN keys. Via this menu a Bulk Dump can also be performed (see page 31).

Press PRESET ON/OFF key once to exit the MIDI channels set mode.

EDITED KNOBS LEDs

The LEDs are relevant in Preset "On" mode only. They indicate when the front controls do not match the settings stored in the actually recalled preset.

ARROW UP/DOWN keys

Scroll between presets when in preset "On" mode.

REAR PANEL

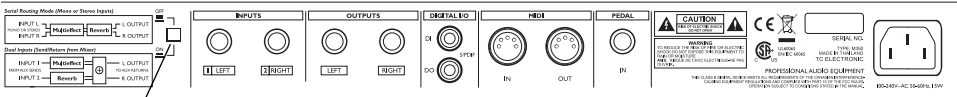

Routing Switch

Balanced Jack Analog Inputs

Balanced Jack Analog Outputs

Digital S/PDIF Input/Output

MIDI In/Out

Pedal Input

Power Input 100 – 240V

ROUTING switch

Switches between Dual Input and Serial routing modes.

Dual Input mode:

Switch is in, and the green LED on the front panel is on.

Serial mode:

Switch is out, and the green LED on the front panel is off.

You can learn much more about these routing options on page 23. See also the suggested setups at pages 10-15.

Analog input

Analog input on 1/4 inch connectors. Use left input for connecting a mono signal.



If you connect a source to the left input only and use Dual Input mode, the input signal is fed to both the Delay/Effects engine and the Reverb engine. This means you can then use the M350 as two independent effect units with a common output.

Analog output

Analog output is a stereo output on two 1/4" jack connectors.

Digital Input/Output

M350 can lock on an incoming 44.1 or 48kHz digital signal via the S/PDIF digital in RCA/phono connector.

M350 always sends on digital out.

- in analog mode, the digital output's clock rate is 44.1kHz.

- when locked to a 44.1kHz digital input signal, the digital output's clock rate is 44.1kHz.

- when locked to a 48kHz digital input signal, the digital output's clock rate is 48kHz.

Pedal input

The Pedal input allows you to bypass and "tap" the global tempo via momentary switches. The global tempo can be used to set delay time. The connection is a 1/4" stereo jack with Bypass on tip and Tap Tempo on ring.

SIGNAL FLOW

M•350

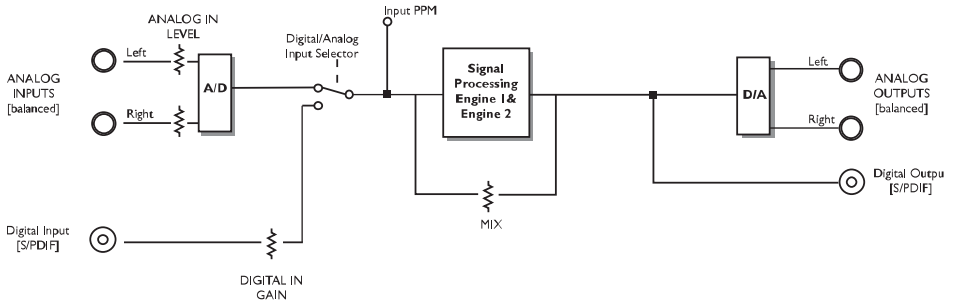

MIDI Cable

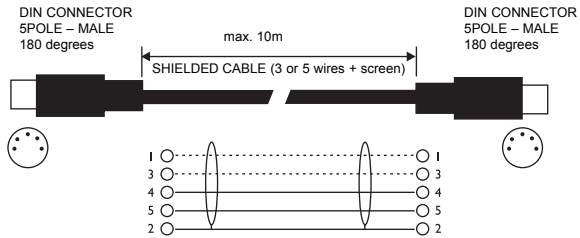

Jack Cable Mono to Mono

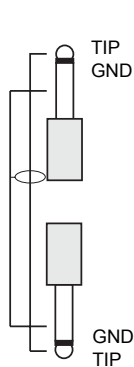

Jack Cable Stereo

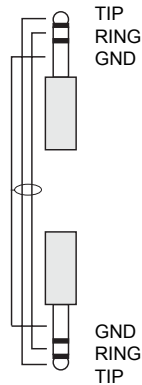

TYPICAL SETUPS

Connecting and Setting up the M350

Setting up the M350 is very easy. It is, however, important to connect and setup the M350 correctly according to your application. Setting up basically means: connecting, selecting one of the two routing options via the switch on the rear panel and finally setting the MIX control on the front panel. Find the setup you are about to create or similar on the following two pages – and follow the instructions.

Setup

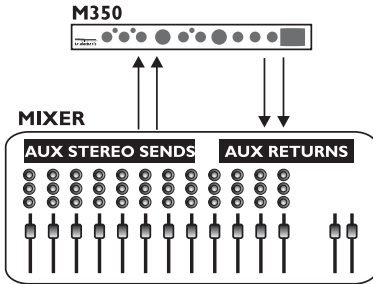

M350 Routing Schematic

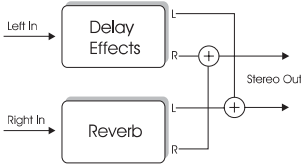

Dual Input mode

This setup applies to a mixer with two (or more) AUX sends. It utilizes the two effect sections in the M350 as two separate effects with a common output.

- On the rear panel, select Dual Input routing mode by leaving the switch in the “in” position.
- Connect AUX 1 send to the M350’s left input.
- Connect AUX 2 send to the M350’s right input.
- Connect the M350’s left and right outputs to the stereo AUX L/R returns of either AUX 1 or AUX 2.
- Set MIX to 100% wet, as in this setup you do not want the direct signal to pass through the M350.
- Set input level to 12 o’clock position.
- Set BALANCE to 12 o’clock position.
- Select Reverb type and Delay/Effects type using the selectors on the front panel.
- Set the AUX return level on the mixer to approx. 50%.
- Now slowly turn up the AUX sends 1 and 2 on the mixer for the channels you wish to add effect to.
- Adjust/fine-tune the M350 input level so the INPUT LED on the front panel often is orange but only rarely peaks at red color.

TYPICAL SETUPS

Setup

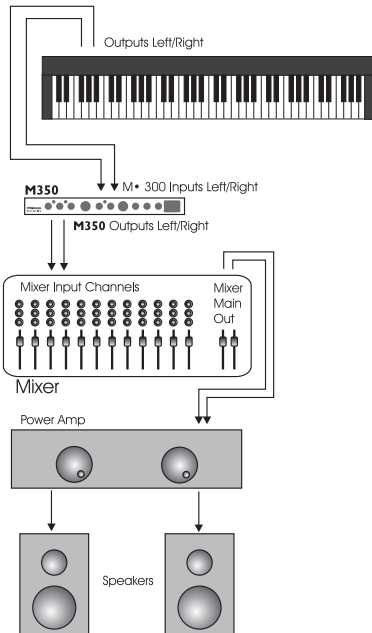

Serial Setup

This setup utilizes the M350 as a delay-effects processor connected in serial to a reverb. It is ideal when you wish to add reverb to a signal already processed by one of the delay-effects. The illustrated setup is a typical live instrument setup.

- On the rear panel, select Serial routing by leaving the switch in "out" position.
- Connect a line signal directly from your instrument or from a DI-box to the M350's inputs (use the left input for mono signals).
- Connect the M350's left and right outputs to mixer or amplification.
- Set input level to 12 o'clock position.
- Set MIX level to 12 o'clock position.
- Set BALANCE to 12 o'clock position.
- Adjust/fine-tune the M350's input level so the INPUT LED on the front panel often is orange but only rarely peaks at red color.
- Select Reverb type and Delay/Effects type using the selectors on the front panel.
- Now fine-tune:
 - MIX between wet and dry signal.
 - BALANCE between the two effect engines.

M350 Routing Schematic



TYPICAL SETUPS

Setup

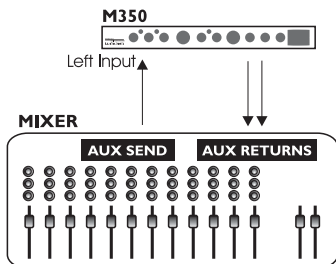

Routing Schematic

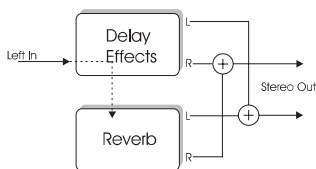

“Parallel Setup” (analog input only)

This setup utilizes the M350 as a dual processor on a mono signal with a common stereo output.

- On the rear panel, select Dual Input routing mode by leaving the ROUTING switch in the “in” position.
- Connect AUX1 (or any) to left input. Make NO connections to right input. The left input signal is automatically fed to the right input internally in the M350.
- Connect the M350’s left and right outputs to the stereo AUX L/R returns of either AUX 1 or AUX 2.
- Set MIX to 100% wet, as in this setup you do not want the direct signal to pass through the M350.
- Set INPUT level to 12 o’clock position.
- Set BALANCE to 12 o’clock position.
- Select Reverb type and Delay/Effects type using the selectors on the front panel.
- Set the AUX return level on the mixer to approx. 50%.
- Now slowly turn up the AUX sends.
- Adjust/fine-tune the M350 input level so the input LED on the front panel often is orange but only rarely peaks at red color.

Controlling M350 via MIDI

Various functions of the M350, such as preset recall and Tap Tempo, can be controlled via an external MIDI device.

This example shows how to control the M350 with a TC Electronic G•Minor* foot controller. A complete list of CC values can be found on page 31.

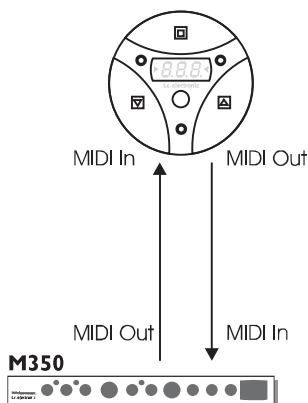

- Connect the G•Minor’s MIDI Out to the M350’s MIDI In.
- Connect the M350’s MIDI Out to the G•Minor’s MIDI In.

You are now able to recall the stored presets in the M350 using the UP/DOWN switches on the G•Minor. You can also tap the Global Tempo using the HOLD switch.

* Detailed information on the G•Minor can be found in the G•Minor manual. Feel free to download the manual from www.tcelectronic.com

TYPICAL SETUPS

Setup

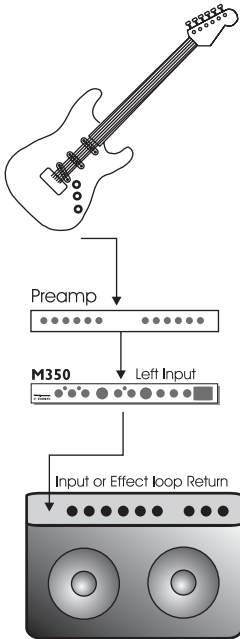

Guitar Setups

This setup utilizes the M350 as a delay-effects processor connected in serial to a reverb. It is ideal when you wish to add reverb to a signal already processed by one of the delay-effects. This is a typical guitar setup.

- On the rear panel, select SERIAL routing by leaving the switch in the "out" position.
- Connect your guitar to the preamp's input.
- Connect the preamp's output to the M350's left input.
- Connect the M350's left output to the input on your amp. Use the regular input or the return on an effect loop if you use combos or heads. If you are using a regular power-amp and speakers simply use the inputs.
- Set INPUT level to 12 o'clock position.
- Set MIX level to 12 o'clock position.
- Set BALANCE to 12 o'clock position.
- Adjust/fine-tune the M350 input level so the INPUT LED on the front panel often is orange but only rarely peaks at red color.
- Select Reverb type and Delay/Effects type using the selectors on the front panel.
- Now fine-tune:
 - MIX between wet and dry signal
 - BALANCE between the two effect engines.

Setup

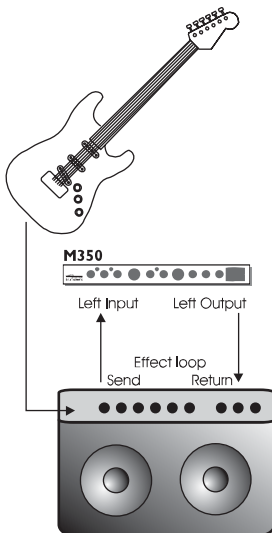

M350 in an effects loop

- On the rear panel select SERIAL routing by leaving the switch in "out" position.
- Connect your guitar to the amp's input.
- Connect the effect-loop send to the M350's left input.
- Connect the M350's left output to the effect-loop return.
- Set input level to 12 o'clock position.
- If the effects loop is serial type (see the amp's owner's manual), set MIX level to 12 o'clock position. If the effects-loop is parallel type, set MIX to 100% (fully clockwise position).
- Set BALANCE to 12 o'clock position.
- Adjust/fine-tune the M350's input level so the INPUT LED on the front panel often is orange but only rarely peaks at red color.
- Select Reverb type and Delay/Effects type using the selectors on the front panel.
- Now fine-tune:
 - BALANCE between the two effect engines.

TYPICAL SETUPS

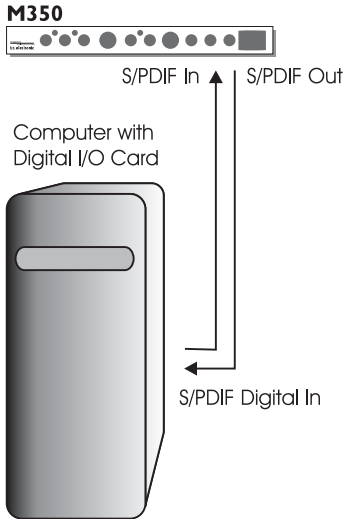

Digital Setup - M350 as Insert

This setup is ideal if you are using the M350 as a digital insert effect on your hard disk recording system.

This setup requires that you are using an I/O card with S/PDIF In/Out.

- Select Serial Routing by leaving the ROUTING switch on the rear panel in "out" position.
- Connect the M350's S/PDIF digital out to the digital input on your soundcard.
- Connect the digital out on your soundcard to the digital in on the M350.
- Set your soundcard to act as master clock. There can be different names for this setting, but "Internal Clock", "Internal Sync" or "Master" are commonly used terms. (This is probably set via your hard disk recording program. Please refer to its owner's manual.)
- Press the DIGI IN button on the M350.
- If the DIGI IN LED is green, the M350 is locked correctly on the digital input signal.
- If the LED is flashing, digital in is selected but no digital signal is received within 5 seconds, or the signal is corrupt.

The M350 automatically returns to internal clock and analog operation but will continue to look for digital signal, and the DIGI IN LED on the front panel will keep blinking. Check cables and make sure that your soundcard is set as master.

- Once set up, you can use the M350 as a plug-in on your hard disk recording system, if this function is supported on your system.

TYPICAL SETUPS

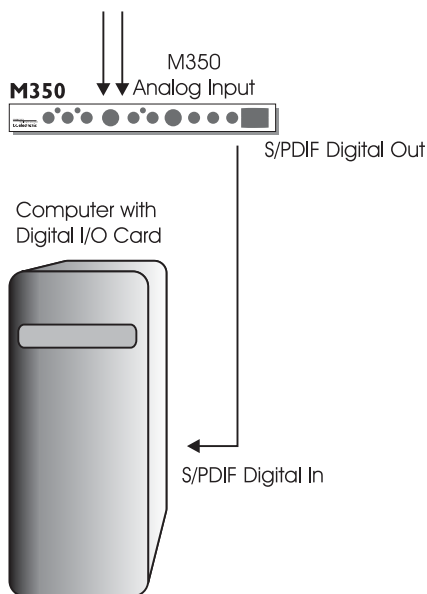

Digital Setup

- M350 as A to D converter

The analog to digital converters in the M350 are superior to most converters used on soundcards in the affordable price range. You can therefore most likely benefit from using the M350 as an A to D converter when doing hard disk recordings.

Feed the M350 with an analog input e.g. from your mixer or instrument line signal, and you are feeding a high quality digital signal from the S/PDIF out to your digital recording system.

You can of course add effects to the tracks while recording if you wish. But the essence of this setup is to get best of the possible A to D converters on your soundcard.

- Select Serial or Dual Input routing mode via the ROUTING switch on the rear panel. Note that if you do not add effects to the tracks while recording and use Bypass mode, you must use Serial routing.
- Feed any analog signal to the analog input on the M350.
- Connect the M350's S/PDIF digital out to the Digital input on your soundcard.
- The M350 must act as master clock in this setup and you must therefore set your soundcard to act as slave. There can be different names for this setting but "External Clock", "External Sync" or "Slave" are commonly used terms. (This is probably set up via your hard disk recording program. Please refer to its owners manual.)
- For pure A to D conversion with no effects added, both Effect Type selectors should be set to Off.
- Adjust input level gain using the INPUT level knob.

OPERATING – INPUT/OUTPUT SECTION

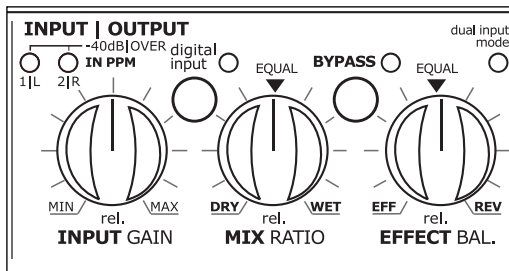

INPUT GAIN

This knob controls the input level for both the analog and digital input options. For optimal performance of the M350, a well-adjusted input level is essential.

Analog Input Range

Counter Clockwise : -10dB
Center : 0dB
Clockwise : +14dB

Digital Input Range

Counter Clockwise : -18dB
Center : 0dB
Clockwise : +6dB

1/L – 2/R INPUT LEDs

These LEDs signal using three colors.

Green : Indicates that you are “well on the safe side”
Yellow : Reaching optimal performance.
Red : Should only occasionally blink at absolute peaks in the material you are feeding the M350 with.

The INPUT knob adjusts the level for both left and right input channels. If there is a significant difference between the input of the left and right channels, you should adjust the output of the device feeding the M350.

DIG. IN

The M350 has both analog and digital input options. The digital input is the S/PDIF type connected via RCA phono cables. To select/deselect the digital input, press the DIG IN button once.

The green LED next to the DIG IN button will indicate various states.

LED Off

Digital input is set to “off”. The M350 processes only the signal present on the analog inputs. This is done at an internal sample rate of 44.1kHz.

LED Green

The M350 is locked correctly to the signal on the digital input. With the digital signal a clock is supplied. The M350 can lock to either a 44.1 or a 48kHz sample rate frequency, which are the most commonly used sample rate frequencies. E.g. a regular CD is 44.1kHz.

Flashing LED

If digital in is selected but no digital signal is received, or if the signal is corrupt, the M350 automatically returns to internal clock and analog operation. However, the M350 will continue to look for a digital signal on the S/PDIF input. This is indicated by the flashing LED. If you wish to stay in analog mode, press DIG IN once and the LED will stop flashing.

Dual Input mode – LED

When this LED is lit (green) it indicates that the Dual Input routing mode has been selected via the switch located on the rear panel. Read more about the Dual Input mode on page 23.

OPERATING – INPUT/OUTPUT SECTION

MIX RATIO

Sets the mix between dry and wet signal. The Mix parameter operates differently depending on the selected routing:

In “Dual S/R” routing, “MIX” controls the overall wet/dry mix of both the Delay/Effects and the Reverb section.

In “Serial” routing, “MIX” functionality in the “Effects” section depends on the selected effect:

The Compressor and De-Esser effects have a fixed mix setting of 100% in Serial routing.

The Chorus, Flanger, Phaser and Tremolo effects have a fixed mix setting of 50% in Serial routing.

Reverb and Delay mix level is set using the MIX knob in Serial routing. To individually adjust the mix setting between Reverb and Delay, use the BALANCE knob.

BYPASS

The bypass function operates differently depending on the selected routing.

Dual Input routing:

Bypass acts as a mute feature, i.e. no signal is sent to the outputs when Bypass is active.

Serial routing:

Here the bypass function simply passes the source signal unprocessed to output.

EFFECTS BAL.

Sets the balance between the two engines. Both engines have their maximum output at the 12 o'clock position.

Fully clockwise or counter-clockwise settings can be considered as 100% bypass of one of the engines.

THE DELAY-EFFECTS ENGINE

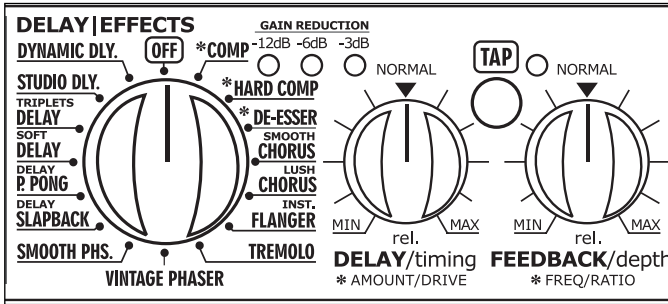

Delay / Effects Engine

Effect Selector

With the EFFECT selector you select between one of the following effects and Off.

- Dynamic Delay
- Studio Delay
- Triplets Delay
- Soft Delay
- Ping Pong Delay
- SlapBack Delay
- Smooth Phaser
- Vintage Phaser
- Tremolo
- Instrument Flanger
- Lush Chorus
- Smooth Chorus
- De-Esser
- Hard Comp
- Comp

-12dB, -6dB, -3dB Gain Reduction LEDs

These LEDs indicate the applied gain reduction in the compression and de-ess algorithms.

TAP key and TIMING knob

Delay Effects:

The tempo of the delay effects is set using both the TAP key and the TIMING knob.

By tapping the TAP key you specify a “global tempo” that you can increase/decrease using the TIMING knob, which operates as a multiplier.

The range of the TIMING knob is 0.5 to 2.

Example

Let us say that you tap quarter notes in tempo 120BPM using the TAP key. With the TIMING knob in 12 o'clock position you now have a delay time of 500ms*.

If you turn the TIMING knob fully counter-clockwise, the actual Delay time will be 0.5 times 500ms = 250ms

If you turn the TIMING knob fully clockwise, the tempo will be:

2 times 500ms = 1000ms (1 second)

When powering up the M350, the default global tempo is 120BPM, but as explained above the position of the TIMING knob defines the actual tempo.

*The Slapback Delay is characterized by very short delay times. Accordingly, the timing range for this delay type is much shorter.

THE DELAY-EFFECTS ENGINE

TIMING knob – De-Ess and Compression:

For the De-Ess algorithm the TIMING knob controls the Amount parameter.

For the Compressor algorithm the TIMING knob controls the Drive parameter.

The higher you set the TIMING knob, the harder the Compressor is hit. Or you could say that the threshold is lowered and make-up gain is applied at the same time as level compensation.

TIMING knob – Chorus, Flanger, Phaser and Tremolo:

Increases/decreases the tempo.

Remember that the default setting suggested by TC Electronic is achieved by setting the knob in 12 o'clock.

FEEDBACK/DEPTH

– FREQUENCY/RATIO knob

This knob changes functionality with the selected algorithms.

The knob controls the Feedback parameter in:

All Delays

The knob controls the Depth parameter in:

Chorus

Flanger

Phaser

Tremolo

The knob controls the Frequency parameter in:

De-Ess

The knob controls the Ratio parameter in:

Compressor

For further details on these parameters, please read the Delay/Effects chapter on pages 24-27.

THE REVERB ENGINE

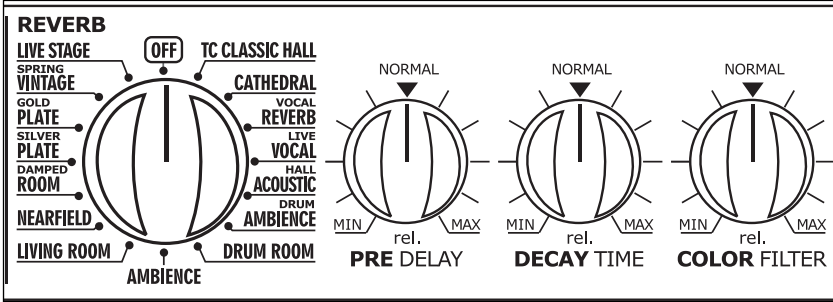

Reverb Engine

Reverb Selector

Select between the following Reverb types or “Off”.

- TC Classic Hall
- Cathedral
- Vocal Reverb
- Live Vocal
- Hall Acoustic
- Drum Ambience
- Drum Room
- Ambience
- Living Room
- Nearfield
- Damped Room
- Silver Plate
- Gold Plate
- Spring Vintage
- Live Stage

To hear the carefully designed default settings for each of the Reverb types set PRE DELAY, DECAY and COLOR knobs in “12 o’clock” position (neutral).

It is worth noticing that the range of each of these parameters will vary from algorithm to algorithm.

As an example it is possible to set a much longer decay time for a Classic or Concert Hall Reverb than for a Drum Box.

Pre Delay

A short delay placed between the direct signal and the reverb’s diffuse field. By using pre-delay the source material is kept clear and undisturbed by the more diffuse “reverb-tail” arriving shortly after.

Decay

The Decay parameter determines the length of the reverb diffuse field. The length is defined as the time it takes for the reverb to decay approximately 60dB.

Color

Varies the “color” of the reverb. From dark to crisp and bright, the Color parameter can really change the characteristics and style of the reverb.

STORE – RECALL & THE DISPLAY

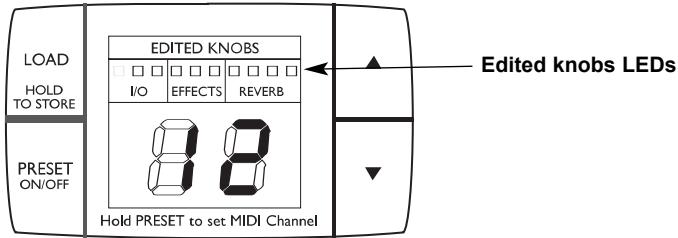

Preset Modes

The M350 holds two significantly different modes. To toggle between these modes, press the PRESET ON/OFF key.

“Preset On” mode

In this mode it is possible to load any of the previously stored presets.

The “Preset On” mode is active when the display shows location numbers from 1 to 99.

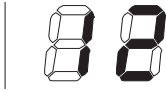

If you try to load a preset from a location where no preset is stored, no action will take place.

“Preset Off” mode

In “Preset Off” mode the M350 processes the signal according to the positions of the front controls – a “what you see is what you hear” setting.

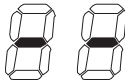

Once you have accessed the Preset Off mode and return to the Preset On mode, the preset number will blink, indicating that you must press LOAD to recall the settings stored with that particular preset.

Display

Edited knobs LEDs

(relevant only in “Preset On” mode)

These LEDs refer to the 10 front panel controls. See illustration above.

They indicate when the front controls do not match the current settings of the active preset.

When you turn any of the knobs and pass the position physically matching the current parameter value, the parameter is “grabbed”, the LED is unlit and you can adjust the parameter.

Load/Store Presets

Load User Preset

- Enter “Preset On” mode using the PRESET ON/OFF key. The M350 is in Preset On mode when the display shows location numbers 1 to 99. Use the UP/DOWN arrows to select desired preset (1-99).
- The digits are now blinking to indicate that you are previewing the preset and that it has not yet been recalled.
- Press LOAD to recall the preset. The digits now are steady.

Store User Preset

- Enter “Preset On” mode using the PRESET ON/OFF key. The M350 is in Preset On mode when the display shows location numbers 1 to 99.
- Use the UP/DOWN arrows to select desired preset location where you intend to store the preset (1-99).
- The digits are now blinking to indicate that you have not yet stored the preset.
- Press the LOAD (HOLD TO STORE) key for approx. 2.5 seconds until the digits turn steady.

MISCELLANEOUS

Factory Presets

The M350 holds no conventional factory presets. When all the controllers are in 12 o'clock position, the M350 is "in neutral", meaning that all parameters are set as suggested by TC Electronic. Combining the 16 positions of both the DELAY/EFFECTS and the REVERB selector, you actually have access to 256 "factory" presets.

MIDI CH.

Via an external MIDI device it is possible to recall presets and control the M350's parameters. To enable communication, the external device and the M350 have to send and receive data on the same MIDI Channel. The M350 can be set to receive on a specific MIDI channel, none or all channels.

- Press and hold PRESET ON/OFF. The currently selected MIDI channel is displayed.

Assuming the M350 is "right out of the box" or that you have performed a Reset procedure as described on page 31, the display now shows:

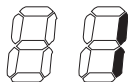

- indicating that channel 1 is selected and the M350 can receive MIDI information on channel 1.

- Use the UP/DOWN arrows to select MIDI channels 1 to 16.
- "O" indicates Omni, which means that the M350 can receive MIDI information on all channels.
- "OF" indicates that the M350 will ignore any incoming MIDI messages.
- Press LOAD to verify and exit menu.

SysEx ID

The M350's SysEx ID is always identical to the set MIDI Channel.

Application Software version

This number indicates the currently loaded application software and is relevant only for servicing purposes.

- Press and hold PRESET ON/OFF and use the UP/DOWN arrows to select "AP" as displayed below.



The display will flash between "AP" (for application) and the currently loaded application software.

Front Software version

This number indicates the currently loaded front software and is relevant only for servicing purposes.

- Press and hold PRESET ON/OFF and use the UP/DOWN arrows to select "Fr" as displayed below.

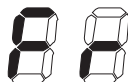

The display will flash between "Fr" (for "Front software") and the currently loaded front software number.

ROUTINGS

It is essential that you have selected the correct routing according to your setup:

Serial Routing

With this routing, the two engines are used as a chain of two effects where the signal first passes the Delay/Effects engine and thereafter the Reverb engine.

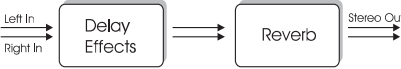

This is the routing to select when you want to add reverb to a signal after the signal has been processed by the Delay/Effects engine. Select the Serial Routing on the rear panel and connect the M350 according to this illustration:

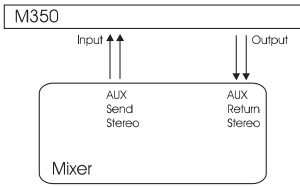

Dual Input routing mode

By routing two different signals to the two effect engines, you can utilize the M350 as two separate effect units with a common output.

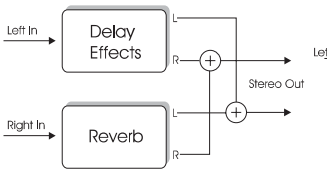

Use this if you wish to use the M350 e.g. to add delay to a guitar on one channel and reverb to a vocal on another channel.

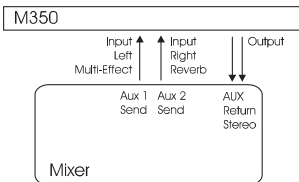

Parallel Routing (analog input only)

This routing gives you the opportunity to have two effects in parallel on a single mono signal.

- Select the Dual Inputs routing by leaving the ROUTING switch on the rear panel in "In" position.
 - Connect a mono signal to left input.
- The input signal is now split and fed to both the Delay/Effects engine and the Reverb engine. Both engines then use left and right outputs as common outputs.

Signal Flow:

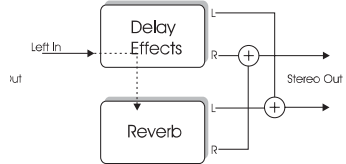

Connect the M350 according to this illustration:

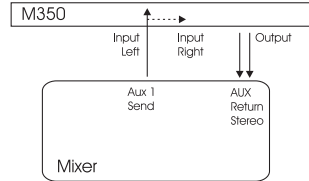

Also see setup examples on pages 10 to 15.

DELAY-EFFECTS

This manual section explains the function of the front panel controls as well as the algorithm parameters in the Delay-effects section.

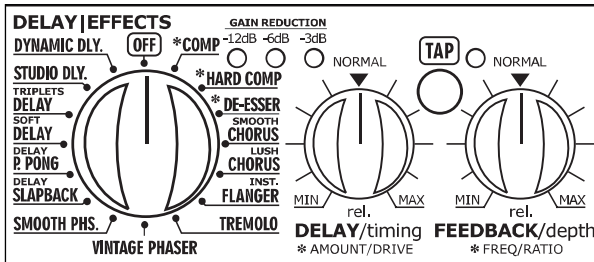

Delay – Controls

TIMING knob

Both the TIMING and the TAP key are used to specify the desired tempo of the repeats. A tempo is tapped on the TAP key and you multiply this tempo using the TIMING knob. The range of the TIMING knob is 0.5 to 2. See example below.

FEEDBACK knob

The FEEDBACK knob sets the number of delay repeats. Leaving the knob in 12 o'clock position gives you the starting point suggested by TC Electronic.

Example – TIMING knob

Let us just explore the Tap Tempo and timing functions a bit further:
With a Studio Delay algorithm selected, you tap quarter notes in tempo 120BPM using the TAP key. With the TIMING knob in 12 o'clock position you now have a Delay time of 500ms.

If you turn the TIMING knob fully counter-clockwise, the actual delay time will be:
 $0.5 \text{ times } 500\text{ms} = 250\text{ms}$

If you turn the TIMING knob fully clockwise, the tempo will be:
 $2 \text{ times } 500\text{ms} = 1000\text{ms} \text{ (1 second)}$



When powering up the M350, the default tempo is 120BPM, but as explained above, the position of the TIMING knob defines the actual tempo.

You should also note that the range varies depending on the selected delay type. E.g., as the Slapback Delay is characterized by short delay times, the Slapback Delay's range is considerably lower than that of other delay algorithms.



When using the M350 in a Dual Input setup, the MIX knob should be set to 100% wet.

Delay Types

Dynamic Delay

The Dynamic Delay initially introduced in the well-recognized TC 2290 is a function that allows the dynamics of the input level to actively alter the delay's output level.

The basic idea is to have a *lower* level of the delay repeats while the instruments are played (or vocals are sung) and an *increased* level of delay when no input is present.

This is a function that leaves the source material clear and undisturbed while played and delicately accompanied by the delay between phrases.

With the correct settings, you will be amazed how you can use delay effects on material where you previously never considered this an option.

DELAY-EFFECTS

Studio Delay

The Studio Delay algorithm will give you a clear reproduction of the material fed to the M350. To soften the Delay (as it is commonly done in studio productions), the Studio Delay uses a subtle yet significant HiCut at a relatively high crossover frequency.

Triplets Delay

Tap the tempo in 1/4 notes and the delay repeats will play in 1/4 note triplets according to the tapped tempo.

Soft Delay

The Soft Delay rolls off the high-end frequencies slightly, giving you delay repeats with less edge that very often blend better and sound more natural in the mix.

PingPong Delay

The PingPong Delay basically pans the delay repeats from left to right and back while keeping the input signal at its original position. This gives a very wide-spread special effect.

Slapback Delay

The Slapback delay is a very short delay with only a single or a few repeats. It is commonly used as a “doubling-effect”, making the processed material seem more massive. Short slapback delays are also often used on funky rhythm guitars – a bit longer on rockabilly guitar or vocals.

Compressor

Compressor Controls

For optimal “ease of use” we have simplified and reduced the common compression controls to the following controls:

Drive (TIMING KNOB)

The higher the Drive setting is, the lower the Threshold point is set – and the harder you will “hit” the Compressor. In other words: The higher the Drive setting, the more compression is added.

Ratio (FEEDBACK/DEPTH KNOB)

This parameter sets the amount of gain reduction of the signal above the “Threshold” – see Drive parameter.

Compression basics

A compressor is a tool used to reduce the dynamic content of a signal. When the signal is above the set threshold, the compressor starts reducing the output level according to the set ratio. A signal with a reduced dynamic range is much easier to control and will have a more consistent sound in any audio production.

Illustration:

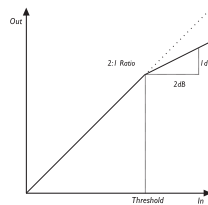

Be aware that compression is a powerful tool. Applying the right amount of compression to specific instruments will create a homogenous, well-defined result. Applying too much compression will probably create a less musical, flat and uninteresting sound.

DELAY-EFFECTS

Parameters associated with Compression

Threshold

As soon as the input signal is above the set threshold point, the output level of the compressor will be reduced according to the specified ratio.

Ratio

Specifies how aggressive the gain reduction of the signal should be. With a ratio setting of e.g. 4:1, for every 4dB that the signal is above the threshold point, only 1dB is passed to the output.

Attack

Specifies how fast the gain reduction specified by the ratio parameter should be applied. The attack rate of the M350 compressor is fixed.

Auto Make-up gain

Since the output of the signal above the set threshold point is reduced, the entire signal will appear to be at a lower volume. In many compressors (including the M350's compressor), Auto Make-up gain is used compensate for this loss of gain.

This way, the output level is maintained and only the dynamic range is changed.

De-Esser

De-Esser Controls

Amount (TIMING KNOB)

Sets the amount of gain reduction around the frequency specified by the FREQUENCY knob.

Frequency (FEEDBACK/DEPTH KNOB)

Sets the frequency around which you would like to reduce frequencies.

A De-Esser is a kind of compressor used to reduce only specific sibilant frequencies. Typically the "s" sounds can be far too dominant in a vocal or backing vocal track and the track would therefore often benefit from being processed by a De-Esser.

Chorus and Flanger

Chorus/Flanger – Controls

TIMING knob

In the Chorus/Flanger algorithms, the TIMING knob sets the speed of the effect.

FEEDBACK/DEPTH knob

In the Chorus/Flanger algorithm, the FEEDBACK/DEPTH knob sets the depth (intensity) of the effect.

A Chorus/Flanger is basically a short delay modulated by an LFO (Low Frequency Oscillator). The differences between chorus and flanging are the applied delay time and the feedback parameter in the Flanger.

The modulation of the short delay gives very small variations in pitch. These pitch changes blended with the direct sound produce the Chorus/Flanger sound.

A chorus effect is typically used as a smoothing effect while the Flanger is more in the genre of "special effects".

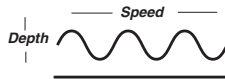

Smooth Chorus & Lush Chorus

The Soft Chorus is ideal for silk-smooth softening of the signal. The Lush Chorus is a better choice for more intense chorus sounds.

Instrument Flanger

The M350 Flanger is optimized to instruments such as guitars, bass and keyboards.

DELAY-EFFECTS

Phaser

Phaser – Controls

TIMING knob

In the Phaser algorithm, the TIMING knob sets the speed of the Phaser.

FEEDBACK/DEPTH knob

In the Phaser algorithm, the FEEDBACK/DEPTH knob sets the depth of the phasing effect.

Smooth Phaser and Vintage Phaser

The Vintage Phaser utilizes four all-pass filters. These filters create comb-looking characteristics. When the filtered sound is mixed with the direct sound, the “phasing sound” occurs.

The Smooth Phaser utilizes twelve all-pass filters. It is the higher number of filters in the Smooth Phaser that allows the Smooth Phaser to sound smoother than the Vintage type.

Hard Tremolo/Soft

Tremolo – Controls

TIMING knob

In the Tremolo algorithm, the TIMING knob sets the speed of the tremolo.

FEEDBACK/DEPTH knob

In the Tremolo algorithm, the FEEDBACK/DEPTH knob sets the depth of the tremolo effect.

Tremolo

A tremolo is basically a repeated level change controlled by an LFO. The M350 offers a Soft Tremolo that uses a “triangular” wave shape. Please see the illustration below.

Soft Tremolo – Triangular shape



REVERBS

The M350 holds the following Reverb types:

- TC Classic Hall
- Cathedral
- Vocal Reverb
- Live Vocal
- Hall Acoustic
- Drum Ambience
- Drum Room
- Ambience
- Living Room
- Nearfield
- Damped Room
- Silver Plate
- Gold Plate
- Spring Vintage
- Live Stage

Each of these reverb types has been created and fine-tuned by the highly experienced staff at TC Electronic and utilizes the vast experience in producing high quality Reverbs accumulated over the past years. And although the M350 is a very compact effects unit in the affordable price range, there is no compromise when it comes the reverb quality.



To find the best starting point for your application, set the three controls in the Reverb section to “12 o’clock” position and “take a trip” round the various reverb types.

By leaving the controls in 12 o’clock position you will hear our suggested settings for each reverb type.

Once you have found the reverb type closest to the desired sound, start twisting the controls.

Pre Delay

A short delay placed between the direct signal and the Reverb Diffuse field. By using pre-delay, the source material is kept clear and undisturbed by the more diffuse reverb diffuse field arriving shortly after.

Decay

The Decay parameter determines the length of the reverb diffuse field. The length is defined as the time it takes for the diffuse field to decay approximately by 60dB.

Color

Varies the “color” of the reverb. From dark to crisp and bright, the Color parameter can really change the characteristics and style of the reverb.

Perception of Reverb types may vary from person to person. This is a rather subjective issue to discuss, describe or even define. However, over the years a general perception of basic reverb types has evolved. We choose to briefly describe the Reverb types found in the M350 like this:

TC Classic Hall

The TC Classic Hall simulates a rather large Hall and preserves the natural characteristics of the source material.

This is excellent for many studio applications requiring medium to long decay times and especially on vocal material.

Cathedral

Where the TC Classic Hall is a reverb with a smooth diffuse field, the Large Cathedral has a much more uneven diffused field. Emphasis on the reflections deriving from many hard surfaces and the high amount of Lo Color naturally occurring in this type of rooms give an excellent simulation of a large Cathedral.

Vocal – Reverb

This preset will match and refine vocal sources which need that “extra something”. The Vocal Reverb preset gives you a soft and mellow tone that is identical to the reflections you get from medium sized rooms with wooden surfaces. Use it to obtain a personal yet subtle and agile sound on your vocals.

Live – Vocal

For live purposes, a rather grainy and bright Reverb is needed to cut through the typical background noise at live locations. The Live Reverb should be used with medium to long Decay times and will work excellently both on vocals and instruments requiring a clear and obvious reverb.

Hall – Acoustic

The Hall Acoustic preset is a broad yet slightly diffuse reverb. It simulates a large environment but adds a distinctive acoustic flavor to the source material. You can use this reverb with great effect on drums and other percussive material, but it can also be used when you want to create an unbiased yet genuine ambience.

REVERBS

Drum – Ambience

This reverb was especially designed to emulate the recording rooms typically used for drums.

The Drum Ambience is a 80's style ambient room with only very short reflections.

The Drum Ambience emulates the reflections in a medium sized drum room with a high ceiling – giving longer but natural sounding reflections compared to the Drum Room.

Drum Room

The Drum Room reverb will flavor your drums and percussive source material with great elegance. The preset simulates a medium-sized room that gives you a relatively long yet natural-sounding reverb. It preserves the full spectrum of the source while giving it an unmistakably quality of brilliance and presence.

Ambience

With focus on the Early Reflections that define the perception of a room size, the Ambience Reverb is typically used on dry recordings or dry drum samples to emulate a feeling of environment. “Ambience” and “Room definition” are the keywords here.

Living Room

As the direct opposite to the Cathedral type, the Living Room algorithm simulates a relatively small, well furnished room. In such a room, many reflections are absorbed by soft materials, and the sound is reflected and sustained only by the walls (covered with wallpaper), windows and maybe some furniture.

Nearfield

If you want a reverb that is tight and characterized by early reflections, the Nearfield reverb will be your preferred choice. It emulates the small amount of natural reverb that occurs in e.g. a studio control room. Use this reverb type to obtain a tight, bright and “smack-in-the-face” sound.

Damped Room

The Damped Room reverb can be used with great results on source material which needs to be very lightly reverberated. This algorithm simulates a small studio or vocal box that is completely padded with soft and absorbing material. It gives you a very tight and “to-the-point” kind of sound.

Silver Plate – Gold Plate

Before the digital era, either reverberating springs or large metallic plates were used to create reverb. Plate reverbs typically have a very diffuse and bright sound. They can be used with great effect on many percussive instruments.

Spring Vintage

The Spring algorithm has been designed to reproduce the sound of the old spring reverbs, such as the ones used in vintage guitar amps.

Live Stage

If you are playing live, you might want a reverb that can cut through all the background noise which is so characteristic of live gigs. The Live Stage preset gives you a grainy and bright reverb that will work equally well on vocals and instruments that need to be distinct and to the point.

APPENDIX – MIDI IMPLEMENTATION CHART

DUAL ENGINE PROCESSOR M350 – APRIL 2006

Function		Transmitted	Recognized	Remarks
Basic Channel	Default	1	1	
	Changed	1-16	OMNI-1-16	
Mode	Default			
	Messages	X	X	
	Altered			
Note Number		X	X	
	True Voice	X	X	
Velocity	Note ON	X	X	
	Note OFF	X	X	
After Touch	Key's	X	X	
	Channel	X	X	
Pitch Bend		X	X	
Control Change		O	O	See the CC list on page 31 for details. All controllers are Single Byte type scaled to parameter range.
Prog Change		O	O	
SysEx		O	O	
Common	Song Pos	X	X	
	Song Sel	X	X	
	Tune			
System real time	Clock	X	O	MIDI TimeClock can be used to set the Delay tempo.
Aux Messages	Commands	X	X	
	Local ON/OFF	X	X	
	All Notes OFF	X	X	
	Active Sense	X	X	
	Reset	X	X	

O: YES Mode 1: OMNI ON, POLY Mode 2: OMNI ON, MONO
X: NO Mode 3: OMNI OFF, POLY Mode 4: OMNI OFF, MONO

APPENDIX – MIDI CC & RESET & BULK DUMP

You can control the parameters listed below by sending MIDI Control Changes from an external MIDI device.

Parameter Control Change number:

In Level	12
Mix	13
Effect Bal.	14
Digi. In	15
Bypass	81

Delay Type	50
Delay/Effects. Off	82
Timing	16
Tap	80
Feedback	17

Rev. Type	51
Rev. Off	83
PreDelay	18
Decay	19
Color	20

MIDI Bulk Dump

By performing a MIDI bulk dump, you can dump all presets to an external MIDI device (e.g. a sequencer) for backup purposes.

- Press and hold the PRESET ON/OFF key for approximately 2.5 seconds.
- Use the ARROW UP/DOWN keys to select Bulk Dump mode.

The display will show:

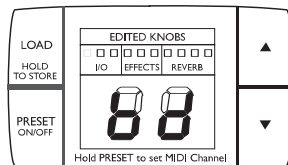

- Set the receiving device to its MIDI Bulk Receive Mode. Please refer to the user manual of the receiving device if you do not know how to do this. With a standard MIDI sequencer, arming a MIDI track for recording should be sufficient.
- Press LOAD once, and the MIDI Bulk Dump will be sent.



The M350 is always ready to receive a MIDI bulk dump unless its MIDI Receive Channel is set to "OF".

Reset Procedure

If you would like to do a complete reset of the M350 and return to factory settings, follow this procedure:

- Power the M350 down by disconnecting the power cord.
- Press and hold TAP while reconnecting power. The display will show a flashing "R".
- Press Load to reset.
- Switch the unit off and on again.

The unit is now reset.



Be aware that all User presets will be lost when performing a factory reset!

APPENDIX – TECHNICAL SPECIFICATIONS

Digital Input and Output

Connector:	RCA Phono (S/PDIF)
Formats:	S/PDIF (24 bit), EIAJ CP-340, IEC 958
Sample Rates:	44.1 kHz, (44.1 kHz and 48 kHz @ Digital Input)
Processing Delay:	0.08 ms @ 48 kHz
Frequency Response DIO:	DC to 23.9 kHz \pm 0.01 dB @ 48 kHz

Analog Inputs

Connectors:	1/4" phone jack balanced, mono sense
Impedance, Bal / Unbal:	21 kOhm / 13 kOhm
Max. / Min. Input Level @ 0 dBFS:	+24 dBu / 0 dBu
Sensitivity Range @ 12 dB headroom:	-12 dBu to +12 dBu
A to D Conversion:	24 bit, 128 x oversampling bitstream
A to D Delay:	0.70 ms / 0.65 ms @ 44.1 kHz / 48 kHz
Dynamic Range:	typ < -92 dB, 22 Hz to 22 kHz
THD:	typ < -90 dB (0.0032 %) @ 1 kHz, -1 dBFS
Frequency Response:	+0/-0.1 dB, 20 Hz to 20 kHz
Crosstalk:	typ < -100 dB, 20 Hz to 20 kHz

Analog Outputs

Connectors:	1/4" phone jack balanced
Impedance Bal / Unbal:	40 Ohm / 20 Ohm
Max. Output Level:	+14 dBu
D to A Conversion:	24 bit, 128 x oversampling bitstream
D to A Delay:	0.68 ms / 0.63 ms @ 44.1 kHz / 48 kHz
Dynamic Range:	typ < -105 dB typ, 22 Hz to 22 kHz
THD:	typ < -97 dB (0.0014 %) @ 1 kHz, +13 dBu
Frequency Response:	+0/-0.5 dB, 20 Hz to 20 kHz
Crosstalk:	typ < -100 dB, 20 Hz to 20 kHz

EMC

Complies with:	EN 55103-1 and EN 55103-2 FCC part 15, Class B, CISPR 22, Class B
----------------	--

Safety

Certified to:	IEC 65, EN 60065, UL6500 and CSA E60065 CSA FILE #LR108093
---------------	---

Environment

Operating Temperature:	32° F to 122° F (0° C to 50° C)
Storage Temperature:	-22° F to 167° F (-30° C to 70° C)
Humidity:	Max. 90 % non-condensing

Control Interface

MIDI:	In/Out: 5 Pin DIN
Pedal:	1/4" phone jack

General

Finish:	Anodized aluminum front Plated and painted steel chassis
Display:	2 x 7 segment + LED's
Dimensions:	19" x 1.75" x 4.2" (483 x 44 x 105.6 mm)
Weight:	3.3 lb. (1.5 kg)
Mains Voltage:	100 to 240 VAC, 50 to 60 Hz (auto-select)
Power Consumption:	<15 W
Warranty Parts and labor:	1 year

Due to continuous development, these specifications are subject to change without notice.